



The Sipwise C5 PRO/CARRIER Handbook mr8.5.9

Sipwise GmbH
<support@sipwise.com>

Contents

1	Introduction	1
1.1	About this Handbook	1
1.2	What is the Sipwise C5 PRO/CARRIER?	1
1.3	The Advantages of the Sipwise C5 PRO/CARRIER	1
1.4	Who is the Sipwise C5 PRO/CARRIER for?	2
1.5	Getting Help	2
1.5.1	Phone Support	2
1.5.2	Ticket System	2
2	Architecture	3
2.1	Platforms	3
2.1.1	CARRIER Platform	3
2.1.2	PRO Platform	4
2.2	Provisioning	5
2.3	API and Web Interface	6
2.4	SIP Signaling and Media Relay	6
2.4.1	SIP Load-Balancer	7
2.4.2	SIP Proxy/Registrar	9
2.4.3	SIP Back-to-Back User-Agent (B2BUA)	9
2.4.4	SIP App-Server	10
2.4.5	Message Routing and Media Relay	11
2.5	MySQL Database	13
2.5.1	Provisioning Database (CARRIER-only)	14
2.5.2	Persistent MySQL Database (CARRIER-only)	14
2.6	Redis Database	15
2.7	High Availability and Fail-Over	15
2.7.1	Overview	15

2.7.2	Nomenclature and Alternatives	15
2.7.3	Core Concepts and Configuration	16
2.7.4	Administration	16
3	Platform Deployment	17
3.1	CARRIER Hardware Platform	17
3.1.1	Hardware Specifications	17
3.1.2	Scaling beyond one Hardware Chassis	19
3.1.3	Architecture for central core and local satellites	20
3.2	PRO Hardware Platform	21
3.2.1	Hardware Specifications	21
3.2.2	Installation Prerequisites	26
3.2.3	Rack-Mount Installation	27
3.2.4	Power Supply Cabling	27
3.2.5	Network Cabling	28
4	VoIP Service Administration Concepts	30
4.1	Contacts	30
4.2	Resellers	30
4.3	SIP Domain	31
4.3.1	Additional SIP Domains	31
4.4	Contracts	32
4.5	Customers	32
4.5.1	Residential and SOHO customers	32
4.5.2	Business customers with the Cloud PBX service	33
4.5.3	SIP Trunking	34
4.5.4	Mobile subscribers	34
4.5.5	Pre-paid subscribers who use your calling cards	34
4.6	Subscribers	34
4.7	SIP Peerings	35

5	VoIP Service Configuration Scenario	37
5.1	Creating a SIP Domain	37
5.2	Creating a Customer	38
5.3	Creating a Subscriber	43
5.4	Domain Preferences	47
5.5	Subscriber Preferences	50
5.6	Creating Peerings	51
5.6.1	Creating Peering Groups	51
5.6.2	Creating Peering Servers	53
5.6.3	Authenticating and Registering against Peering Servers	65
5.7	Configuring Rewrite Rule Sets	67
5.7.1	Inbound Rewrite Rules for Caller	70
5.7.2	Inbound Rewrite Rules for Callee	72
5.7.3	Outbound Rewrite Rules for Caller	73
5.7.4	Outbound Rewrite Rules for Callee	74
5.7.5	Emergency Number Handling	74
5.7.6	Assigning Rewrite Rule Sets to Domains and Subscribers	76
5.7.7	Creating Dialplans for Peering Servers	77
5.7.8	Call Routing Verification	77
6	Features	83
6.1	About the Admin Web Interface	83
6.1.1	Filtering the Lists / Databases	83
6.1.2	Call History	84
6.2	Managing System Administrators	85
6.2.1	Configuring Administrators	85
6.2.2	Access Rights of Administrators	87
6.3	Access Control for SIP Calls	89
6.3.1	Block Lists	89

6.3.2	NCOS (Network Class of Service) Levels	91
6.3.3	IP Address Restriction	99
6.3.4	CLI-based Access Control	99
6.3.5	Call Limit Control	100
6.4	Call Forwarding and Call Hunting	101
6.4.1	Call Forward Types	101
6.4.2	Setting a simple Call Forward	102
6.4.3	Call Forward Destinations	102
6.4.4	Advanced Call Hunting	103
6.5	Call Forking by Q value	111
6.5.1	The Q value	111
6.5.2	The Standard Method	112
6.5.3	The Probability Method	112
6.5.4	Advanced Configurations	112
6.6	Local Number Porting	113
6.6.1	Local LNP Database	113
6.6.2	External LNP via LNP API	117
6.7	Emergency Mapping	122
6.7.1	Emergency Mapping Description	122
6.7.2	Emergency Mapping Configuration	123
6.8	Emergency Priorization	129
6.8.1	Call-Flow with Emergency Mode Enabled	130
6.8.2	Configuration of Emergency Mode	133
6.8.3	Activating Emergency Mode	134
6.9	SIP Message Filtering	135
6.9.1	Header Filtering	135
6.9.2	Codec Filtering	136
6.9.3	Enable History and Diversion Headers	137

6.9.4 User Agent Filtering	137
6.10 SIP Trunking with SIPconnect	138
6.10.1 User provisioning	138
6.10.2 Inbound calls routing	138
6.10.3 Number manipulations	139
6.10.4 Registration	141
6.11 Trusted Subscribers	142
6.12 Peer Probing	142
6.12.1 Introduction to Peer Probing Feature	142
6.12.2 Configuration of Peer Probing	143
6.12.3 Monitoring of Peer Probing	145
6.12.4 Further Details for Advanced Users	146
6.13 Fax Server	146
6.13.1 Fax2Mail Architecture	147
6.13.2 Sendfax and Mail2Fax Architecture	147
6.14 Voicemail System	148
6.14.1 Accessing the IVR Menu	148
6.14.2 IVR Menu Structure	149
6.14.3 Type Of Messages	150
6.14.4 Folders	151
6.14.5 Voicemail Languages Configuration	151
6.14.6 Flowcharts with Voice Prompts	152
6.15 Configuring Subscriber IVR Language	157
6.16 Sound Sets	157
6.16.1 Sound_Set and Contract_Sound_Set Usage	158
6.16.2 Configuring Early Reject Sound Sets	158
6.16.3 Play an announcement on behalf of callee server failure in case of outbound calls	164
6.17 Conference System	164

6.17.1	Configuring Call Forward to Conference	164
6.17.2	Configuring Conference Sound Sets	165
6.17.3	Joining the Conference	167
6.17.4	Conference Flowchart with Voice Prompts	167
6.18	Malicious Call Identification (MCID)	169
6.18.1	Setup	169
6.18.2	Usage	170
6.19	Subscriber Profiles	170
6.19.1	Subscriber Profile Sets	170
6.20	SIP Loop Detection	173
6.21	Call-Through Application	173
6.21.1	Activation	173
6.21.2	Administrative Configuration	174
6.21.3	Call Flow	176
6.22	Calling Card Application	177
6.22.1	Administrative Configuration	178
6.22.2	Call Flow	180
6.23	Invoices and Invoice Templates	181
6.23.1	Invoices Management	181
6.23.2	Invoice Management via REST API	183
6.23.3	Invoice Templates	188
6.24	Email Reports and Notifications	198
6.24.1	Email events	198
6.24.2	Initial template values and template variables	198
6.24.3	Subscriber password reset email template	198
6.24.4	Administrator password reset email template	199
6.24.5	New subscriber notification email template	199
6.24.6	Invoice email template	200

6.24.7 Email templates management	202
6.25 The Vertical Service Code Interface	204
6.25.1 Vertical Service Codes for PBX customers	205
6.25.2 Configuration of Vertical Service Codes	205
6.25.3 Voice Prompts for Vertical Service Code Configuration	206
6.26 Handling WebRTC Clients	207
6.27 XMPP and Instant Messaging	208
6.28 Call Recording	208
6.28.1 Introduction to Call Recording Function	208
6.28.2 Information on Files and Directories	209
6.28.3 Configuration	209
6.28.4 REST API	214
6.28.5 Pre-Recording Announcement	215
6.29 Media Transcoding	215
6.29.1 Overview	215
6.29.2 Supported Codecs	215
6.29.3 Configuration	216
6.29.4 T.38 transcoding	219
6.30 Announcement Before Call Setup	219
6.31 Announcement To Callee	220
6.32 Store Recent Calls and Redial	220
6.32.1 Configuring Recent Calls Sound Sets	221
6.32.2 Advanced configuration	222
6.33 SMS (Short Message Service) on Sipwise C5	222
6.33.1 Configuration	224
6.33.2 Monitoring, troubleshooting	225
6.33.3 REST API	232
6.34 Time sets management	233

6.34.1 Time sets specifications and data description	233
6.34.2 Web interface for the time sets	234
6.34.3 Web interface for the time set events	236
6.34.4 Web interface for time set related to reseller	244
6.34.5 REST API	245
6.35 Generation of 181 Call Is Being Forwarded	246
6.35.1 Overview	246
6.35.2 How to enable it	247
6.35.3 How it works	247
6.36 Header Manipulations	247
6.36.1 Overview	247
6.36.2 Sets	248
6.36.3 Rules	248
6.36.4 Conditions	249
6.36.5 Actions	250
6.36.6 Special Headers	251
6.36.7 Usage	251
6.36.8 Usage Examples	252
6.37 Phonebook	255
6.37.1 Overview	255
6.37.2 Inheritance	255
6.37.3 Reseller Phonebook	255
6.37.4 Customer Phonebook	256
6.37.5 Subscriber Phonebook	257
6.37.6 Using CSV Upload and Download	257
6.37.7 Manually enabling Phonebook in a PBX device	258
7 Customer Self-Care Interface and Menus	259
7.1 The Customer Self-Care Web Interface	259

7.1.1	Login Procedure	259
7.1.2	Site Customization	259
7.2	The Voicemail Menu	265
8	Billing Configuration	266
8.1	Billing Profiles	266
8.1.1	Creating Billing Profiles	266
8.1.2	Creating Billing Fees	268
8.1.3	Creating Off-Peak Times	271
8.2	Peak Time Call Rating Modes	273
8.2.1	Introduction to Call Rating Modes	273
8.2.2	Typical Use Cases for Call Rating Modes	274
8.2.3	Configuration of Call Rating Modes	274
8.3	Prepaid Accounting	274
8.4	Fraud Detection and Locking	275
8.4.1	Fraud Lock Levels	275
8.5	Billing Customizations	276
8.5.1	Billing Networks	277
8.5.2	Profile Mapping Schedule	279
8.5.3	Profile Packages	283
8.5.4	Vouchers	293
8.5.5	Top-up	296
8.5.6	Balance Overviews	298
8.5.7	Usage Examples	301
8.6	Notes on Billing and Call Rating	303
8.7	Billing Data Export	304
8.7.1	Glossary of Terms	304
8.7.2	File Name Format	305
8.7.3	File Format	305

8.7.4	File Transfer	318
9	Corosync/Pacemaker	320
9.1	Overview	320
9.2	Migration	320
9.2.1	Rollback	321
9.3	Corosync	321
9.3.1	Quorum	321
9.4	Pacemaker	321
9.5	Query Status	322
9.6	Config Management	323
9.6.1	General Concepts	325
9.6.2	Resources	325
9.6.3	Cluster Options	328
9.6.4	Failure Counts	329
9.6.5	Resource Scores	330
9.7	Common Tasks	331
9.7.1	Takeover and Standby	331
9.7.2	Node Status (Online/Standby)	331
9.7.3	Maintenance Mode	332
9.7.4	CLI Alternatives	332
10	Provisioning REST API Interface	333
10.1	API Workflows for Customer and Subscriber Management	333
10.2	API performance considerations	338
11	Configuration Framework	339
11.1	Configuration templates	339
11.1.1	.tt2, .customtt.tt2 and .patchtt.tt2 files	339
11.1.2	Using patchtt for generation of a relevant customtt file	342

11.1.3	.prebuild and .postbuild files	343
11.1.4	.services files	344
11.2	config.yml, constants.yml and network.yml files	345
11.3	ngcpcfg and its command line options	345
11.3.1	apply	345
11.3.2	build	345
11.3.3	commit	346
11.3.4	decrypt	346
11.3.5	diff	346
11.3.6	encrypt	346
11.3.7	help	346
11.3.8	initialise	346
11.3.9	pull	347
11.3.10	push	347
11.3.11	services	347
11.3.12	status	347
12	Network Configuration	348
12.1	General Structure	348
12.1.1	Available Host Options	349
12.1.2	Interface Parameters	350
12.2	Advanced Network Configuration	352
12.2.1	Additional entries in /etc/hosts	352
12.2.2	Extra SIP Sockets	353
12.2.3	Extra SIP and RTP Sockets	354
12.2.4	Alternative RTP Interface Selection Using ICE	358
12.2.5	Extended RTP Port Range Using Multiple Interfaces	359
12.2.6	Cluster Sets	360
13	Licenses	364

13.1 What is Subject to Licensing?	364
13.2 How Licensing Works	364
13.3 How to Configure Licenses	365
13.4 How to Monitor License Client	365
14 Software Upgrade	366
14.1 Release Notes	366
14.2 Overview	366
14.3 Planning a software upgrade	367
14.4 Pre-upgrade checks	367
14.4.1 Log into the C5 standby management node	367
14.4.2 Check the overall system status	368
14.4.3 Check access to license server and license validity	369
14.4.4 Evaluate and update custom modifications	369
14.4.5 Check system integrity	370
14.4.6 Check the configuration framework status	370
14.4.7 Check access to deb.sipwise.com	371
14.4.8 License check	372
14.5 Pre-upgrade steps	372
14.5.1 ngcp-upgrade options	373
14.5.2 Preparing for maintenance mode	373
14.5.3 Download new package metadata into the approx cache (on the standby node only)	374
14.6 Upgrading Sipwise C5 CARRIER	374
14.6.1 Upgrading ONLY the first standby management node "A" (web01a/db01a)	374
14.6.2 Custom configuration templates	375
14.6.3 Upgrading the standby database node "A" (db*a)	376
14.6.4 Upgrading other standby nodes "A" (lb*a/prx*a)	376
14.6.5 Promote ALL standby nodes "A" to active.	376
14.6.6 Upgrading ALL standby nodes "B" (web*b/db*b/lb*b/prx*b)	377

14.7 Upgrading Sipwise C5 PRO	377
14.7.1 Upgrade the first PRO node	377
14.7.2 The custom modification handling (optional)	378
14.7.3 Promote the upgraded standby node to active	378
14.7.4 Upgrade the second PRO node	378
14.8 Post-upgrade steps	379
14.8.1 Disabling maintenance mode	379
14.8.2 Post-upgrade checks	379
14.9 Applying the Latest Hotfixes	380
14.9.1 Update the approx cache on the standby management node	380
14.9.2 Apply hotfixes on the standby management node	380
14.9.3 Recheck or update the custom configuration templates	380
14.9.4 Apply hotfixes on all other standby nodes (CARRIER-only)	380
14.9.5 Promote the standby nodes to active	381
14.9.6 Apply hotfixes on the second node	381
15 Backup, Recovery and Database Maintenance	382
15.1 Sipwise C5 Backup	382
15.1.1 What data to back up	382
15.1.2 The built-in backup solution	382
15.2 Recovery	383
15.3 Reset Database	383
15.4 Synchronize database	384
15.5 Accounting Data (CDR) Cleanup	386
15.5.1 Cleanuptools Configuration	386
15.5.2 Accounting Database Cleanup	386
15.5.3 Exported CDR Cleanup	389
16 Platform Security, Performance and Troubleshooting	391
16.1 Sipwise SSH access to Sipwise C5	391

16.2 Firewalling	392
16.2.1 Firewall framework	392
16.2.2 Sipwise C5 firewall configuration	393
16.2.3 IPv4 System rules	394
16.2.4 Custom rules	397
16.2.5 Example firewall configuration section	398
16.3 Password management	398
16.3.1 The "root" account	398
16.3.2 The "administrator" account	399
16.3.3 The "cdrexport" account	399
16.3.4 The MySQL "root" user	399
16.3.5 The "ngcpsoap" account	399
16.4 Remote <i>root</i> logins via SSH	399
16.5 <i>sudo-io</i> : logging input/output of commands run through <i>sudo</i>	400
16.6 SSL certificates	401
16.7 Securing your Sipwise C5 against SIP attacks	402
16.7.1 Denial of Service	402
16.7.2 Bruteforcing SIP credentials	403
16.8 Topology Hiding	404
16.8.1 Introduction to Topology Hiding on NGCP	404
16.8.2 Topology Masking Mechanism	404
16.8.3 Topology Hiding Mechanism	406
16.9 System Requirements and Performance	407
16.10 Troubleshooting	409
16.10.1 Collecting call information from logs	411
16.10.2 Collecting SIP traces	412
16.11 Log file obfuscation	414
16.11.1 Configuration	415

16.11.2	Forward and reverse lookup	416
16.12	NGCP Panel passwords encryption	417
17	Monitoring and Alerting	418
17.1	Internal Monitoring	418
17.1.1	Service monitoring	418
17.1.2	System monitoring via Telegraf	418
17.1.3	Sipwise C5 specific monitoring via ngcp-witnessd	418
17.1.4	Monitoring data in InfluxDB	419
17.2	Statistics Dashboard	419
17.3	External Monitoring Using SNMP	420
17.3.1	Overview and Initial Setup	420
17.3.2	Details	421
18	Extensions and Additional Modules	427
18.1	Cloud PBX	427
18.1.1	PBX Device Provisioning	427
18.1.2	Preparing PBX Rewrite Rules	429
18.1.3	Creating Customers and Pilot Subscribers	433
18.1.4	Creating Regular PBX Subscribers	443
18.1.5	Assigning Subscribers to a Device	449
18.1.6	Configuring Sound Sets for the Customer PBX	457
18.1.7	Auto-Attendant Function	459
18.1.8	Cloud PBX Groups with Busy Members	465
18.1.9	Configuring Call Queues	467
18.1.10	Device Auto-Provisioning Security	469
18.1.11	Device Bootstrap and Resync Workflows	471
18.1.12	Device Provisioning and Deployment Workflows	479
18.1.13	List of available pre-configured devices	482
18.1.14	Phone features	487

18.1.15 Shared line appearance	519
18.2 Sipwise sip:phone App (SIP client)	519
18.2.1 Zero Config Launcher	520
18.2.2 Mobile Push Notification	524
18.3 Lawful Interception	545
18.3.1 Introduction	545
18.3.2 Architecture and Configuration of LI Service	547
18.3.3 X1, X2 and X3 Interface Specification	557
18.4 3rd Party Call Control	572
18.4.1 Introduction	572
18.4.2 Details of Call Processing with PCC	572
18.4.3 Voicemail Notification	579
18.4.4 Incoming Short Message Acceptance	581
18.4.5 Configuration of PCC	583
18.4.6 Troubleshooting of PCC	583
A Basic Call Flows	587
A.1 General Call Setup	587
A.2 Endpoint Registration	588
A.3 Basic Call	591
A.4 Session Keep-Alive	592
A.5 Voicebox Calls	593
B Sipwise C5 configs overview	595
B.1 config.yml Overview	595
B.1.1 apps	595
B.1.2 asterisk	595
B.1.3 autoprov	597
B.1.4 backuptools	597
B.1.5 bootenv	598

B.1.6 cdlexport	599
B.1.7 cleanuptools	600
B.1.8 cluster_sets	601
B.1.9 database	602
B.1.10 faxserver	602
B.1.11 general	602
B.1.12 ha	603
B.1.13 haproxy	603
B.1.14 heartbeat	604
B.1.15 intercept	604
B.1.16 kamailio	604
B.1.17 ngcp-lnpd	619
B.1.18 ngcp-logfs	619
B.1.19 ngcp-mediator	620
B.1.20 modules	620
B.1.21 monitoring	620
B.1.22 nginx	621
B.1.23 ntp	622
B.1.24 ossbss	622
B.1.25 pbx (only with additional cloud PBX module installed)	624
B.1.26 prosody	624
B.1.27 pushd	624
B.1.28 qos	627
B.1.29 ngcp-rate-o-mat	628
B.1.30 redis	628
B.1.31 reminder	628
B.1.32 rsyslog	629
B.1.33 rtpproxy	629

B.1.34 security	631
B.1.35 sems	632
B.1.36 sms	634
B.1.37 snmpd	636
B.1.38 snmptrapd	636
B.1.39 snmpagent	637
B.1.40 sshd	637
B.1.41 sudo	637
B.1.42 telegraf	638
B.1.43 voisniff	638
B.1.44 ngcp-witnessd	640
B.1.45 www_admin	641
B.2 constants.yml Overview	644
B.3 network.yml Overview	644
C MariaDB encryption	649
C.1 Overview	649
C.2 Configuration	649
C.3 What is not encrypted	649
C.4 Data restoration remarks	650
D Faxserver Configuration	651
D.1 Faxserver Components	651
D.2 Enabling Faxserver	651
D.3 Fax Templates Configuration	652
D.4 Fax Services Configuration per Subscriber	652
D.5 Fax2Mail and SendFax Settings	653
D.6 Mail2Fax Settings	654
D.7 Sending Fax from Web Panel	656
D.8 Faxserver Mail2Fax Configuration	657

D.9	Sending Fax Using E-mail Clients	657
D.10	Managing Faxes via the REST API	658
D.10.1	Configuring Fax Settings	658
D.10.2	Sending a Fax	659
D.10.3	Receiving a Fax	660
D.10.4	Configuring Mail2Fax Settings	660
D.10.5	Using Advanced Faxserver and Mail2Fax Settings via the REST API	662
D.11	Troubleshooting	662
D.11.1	Session ID (SID)	662
D.11.2	Fax Storage Location	663
D.12	Adjusting the PBX Devices Configuration	664
D.12.1	Setting up Device Models	665
D.12.2	Uploading Device Firmwares	668
D.12.3	Creating Device Configurations	669
D.12.4	Creating Device Profiles	671
E	RTC:engine	673
E.1	Overview	673
E.2	RTC:engine enabling	673
E.2.1	Enabling services via CLI	673
E.2.2	Enabling via Panel for resellers and subscribers	674
E.2.3	Create RTC:engine session	674
E.3	RTC:engine protocol details	675
E.3.1	Terminology	675
E.3.2	Messages	676
E.3.3	Account	678
E.3.4	Call	683
E.3.5	Session	689
F	comx-fileshare-service	691

F.1	Overview	691
F.2	Configuration and Usage	691
F.2.1	Change authentication method	691
F.2.2	Database Structure	692
F.3	Activation of Filesharing Service on NGCP	693
F.4	Message Sequence Chart	694
F.4.1	Simple Message Sequence	694
F.4.2	Detailed Message Sequence	695
F.5	API of Filesharing Service	695
F.5.1	HTTP Authentication	695
F.5.2	Upload and Download with Simple Identification	696
F.5.3	Upload and Download with Session Identification	696
F.5.4	Curl Example for Simple Upload Request	696
F.5.5	Upload Parameters	696
F.5.6	Number of Possible Downloads	698
G	Disk partitioning	699
G.1	Supported IO drives	699
G.2	Hardware vs. software RAID	699
G.3	The default disk partitions	699
G.4	UEFI	700
G.5	Swap partition vs. file	700
H	Storage Node	702
H.1	Overview	702
H.2	Deployment	702
H.3	Configuration	702
I	NGCP Internals	703
I.1	Pending reboot marker	703

I.2	Redis id constants	703
I.3	InfluxDB monitoring keys	704
I.4	Preferences	705
I.4.1	Tables	705
I.4.2	Columns	705
I.4.3	Enum	706
J	Kamailio pv_headers module	708
J.1	Module overview	708
J.2	Template changes	708
J.3	Module documentation	709
J.3.1	Parameters	709
J.3.2	Functions	710
J.3.3	Pseudovariables	713
K	Extra Configuration Scenarios	718
K.1	AudioCodes devices workaround	718
K.2	"Debug Proxy" for troubleshooting	718

1 Introduction

1.1 About this Handbook

This handbook describes the architecture and the operational steps to install, operate and modify the Sipwise C5 PRO/CARRIER.

In various chapters, it describes the system architecture, the installation and upgrade procedures and the initial configuration steps to get your first users online. It then dives into advanced preference configurations such as rewrite rules, call blocking, call forwarding, etc.

There is a description of the customer self-care interface, how to configure the billing system and how to provision the system via the API.

Finally, it describes the internal configuration framework, the network configuration and gives hints about tweaking the system for better security and performance.

1.2 What is the Sipwise C5 PRO/CARRIER?

Sipwise C5 (also known as NGCP - the Next Generation Communication Platform) is a SIP-based Open Source Class 5 VoIP soft-switch platform that allows you to provide rich telephony services. It offers a wide range of features (e.g. call forwarding, voicemail, conferencing etc.) that can be configured by end users in the self-care web interface. For operators, it offers a web-based administrative panel that allows them to configure subscribers, SIP peerings, billing profiles, and other entities. The administrative web panel also shows the real-time statistics for the whole system. For tight integration into existing infrastructures, Sipwise C5 provides a powerful REST API interface.

Sipwise C5 has three solutions that differ in call capacity and service redundancy: CARRIER, PRO and CE. The current handbook describes the PRO/CARRIER solution.

The Sipwise C5 CARRIER comes pre-installed on six or more servers in one or more Lenovo Flex System Enterprise Chassis, see Section 2. Apart from your product specific configuration, there is no initial configuration or installation to be done to get started.

The Sipwise C5 PRO can be pre-installed on two hardware servers or deployed in a customer virtual environment. Apart from your product specific configuration, there is no initial configuration or installation to be done to get started.

1.3 The Advantages of the Sipwise C5 PRO/CARRIER

Opposed to free VoIP software, Sipwise C5 is not a single application, but a complete software platform based on Debian GNU/Linux.

Using a highly modular design approach, Sipwise C5 leverages popular open-source software like MySQL, NGINX, Kamailio, SEMS, Asterisk, etc. as its core building blocks. These blocks are glued together using optimized and proven configurations and workflows and are complemented by functionality developed by Sipwise to provide fully-featured and easy-to-operate VoIP services.

The installed applications are managed by the Sipwise C5 Configuration Framework. This configuration framework makes it

possible to change low-level system parameters in a single place, so Sipwise C5 administrators don't need to have any knowledge of dozens of different configuration files from different packages. This provides a very easy and bullet-proof way of operating, changing and tweaking an otherwise quite complex system.

Once configured, integrated web interfaces are provided for both end users and Sipwise C5 administrators. Provisioning and billing API allows companies to tightly integrate Sipwise C5 into existing OSS/BSS infrastructures to optimize workflows.

1.4 Who is the Sipwise C5 PRO/CARRIER for?

The Sipwise C5 PRO/CARRIER are specifically tailored to companies who want to provide fully-featured SIP-based VoIP service without having to go through the steep learning curve of SIP signalling. It integrates the different building blocks to make them work together in a reasonable way. The Sipwise C5 PRO/CARRIER is already deployed all around the world by all kinds of VoIP operators, using it as Class5 soft-switch, as Class4 termination platform or even as Session Border Controller with all kinds of access networks, like Cable, DSL, WiFi and Mobile networks.

1.5 Getting Help

1.5.1 Phone Support

Depending on your support contract, you are eligible to contact our Support Team by phone either during business hours or around the clock. Business hours refer to the CET/CEST time zone (Europe/Vienna). Please check your support contract to find out the type of support you've purchased.

Before calling our Support Team, please also open a ticket in our Ticket System and provide as much detail as you can for us to understand the problems, fix them and investigate the cause. Please provide the number of your newly created ticket when asked by our support personnel on the phone.

You can find phone numbers, Ticket System URL, and account information in your support contract. Please make this information available to the persons in your company maintaining Sipwise C5.

1.5.2 Ticket System

Depending on your support contract, you can create either a limited or an unlimited amount of support tickets on our Web-based Ticket System. Please provide as much information as possible when opening a ticket, especially the following:

- **WHAT** is affected (e.g. the whole system is unreachable, or customers can't register or place calls)
- **WHO** is affected (e.g. all customers, only parts of it, and **WHICH** parts - only customers in a particular domain or customers with specific devices, etc.)
- **WHEN** did the problem occur (time frames, or after the firmware of specific devices types have been updated, etc.)

Our Support Team will ask further questions via the Ticket System along the way of troubleshooting your issue. Please provide the information as soon as possible to solve your issue promptly.

2 Architecture

2.1 Platforms

2.1.1 CARRIER Platform

The Sipwise C5 CARRIER platform is composed by a cluster of four different node types, which are all deployed in active/standby pairs:

- **Web-Servers** (web1a/web1b): Provide northbound interfaces (CSC, API) via HTTPS for provisioning
- **DB-Servers** (db1a/db1b): Provide the central persistent SQL data store for customer data, peering configuration, billing data etc.
- **Proxy-Servers** (proxy1a/proxy1b .. proxy4a/proxy4b): Provide the SIP and XMPP signalling engines, application servers and media relays to route Calls and IM/Presence and serve media to the endpoints.
- **Load-Balancers** (lb1a/lb1b): Provide a perimeter for SIP and XMPP signalling.

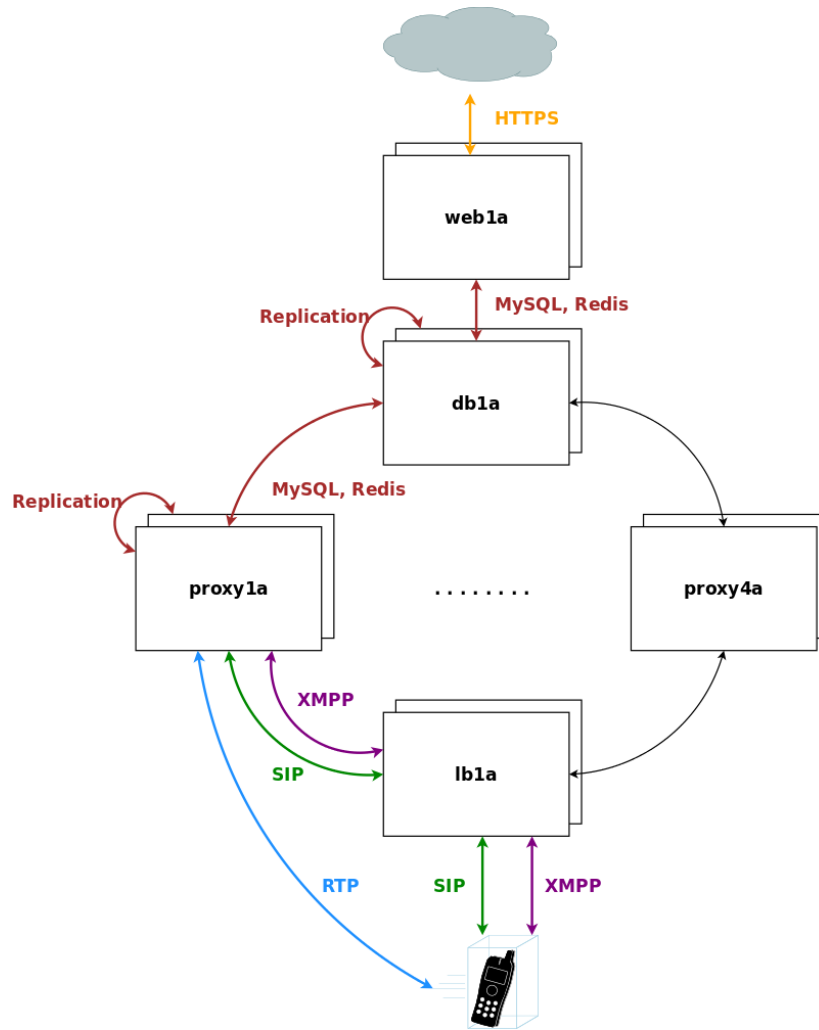

Figure 1: CARRIER Architecture Overview

The system is provisioned via the web servers on a central pair of db servers. Signalling is entering the system via the lb servers to a cluster of proxies, which in turn communicate directly (caching and shared data) and indirectly (static provisioning data replicated via master/slave) with the db servers. Each pair of proxy is capable of handling any subscriber, so subscribers are not bound to specific "home proxies". Once a call starts on a proxy pair, it is ensured that the full range of services is provided on that pair (voicemail, media, billing, ...) until call-teardown. Failures on an active proxy node cause a fail-over to the corresponding stand-by node within the proxy pair, taking over the full signalling and media without interruptions.

2.1.2 PRO Platform

The Sipwise C5 PRO platform consists of two identical appliances working in active/standby mode. The components of a node are outlined in the following figure:

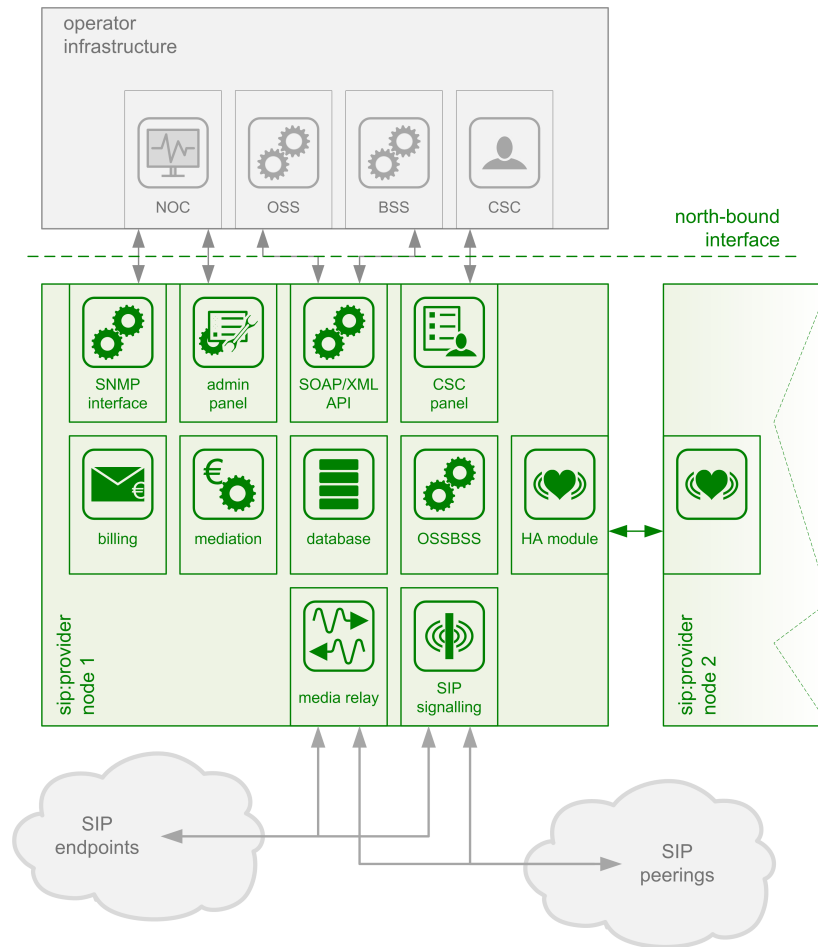

Figure 2: PRO Architecture Overview

The main building blocks of Sipwise C5 are:

- Provisioning
- SIP Signaling and Media Relay
- Mediation and Billing
- Monitoring and Alerting
- High Availability and Fail-Over

2.2 Provisioning

Any HTTPS traffic for provisioning (web interfaces, northbound APIs) but also for phone auto-provisioning enters the platform on the active web server. The web server runs an nginx instance acting as a reverse proxy for the ngcp-panel process, which in turn provides the provisioning functionality.

The web server is connected to the db server pair, which provides a persistent relational data store via MySQL and a high-performance system cache using Redis key-value store.

2.3 API and Web Interface

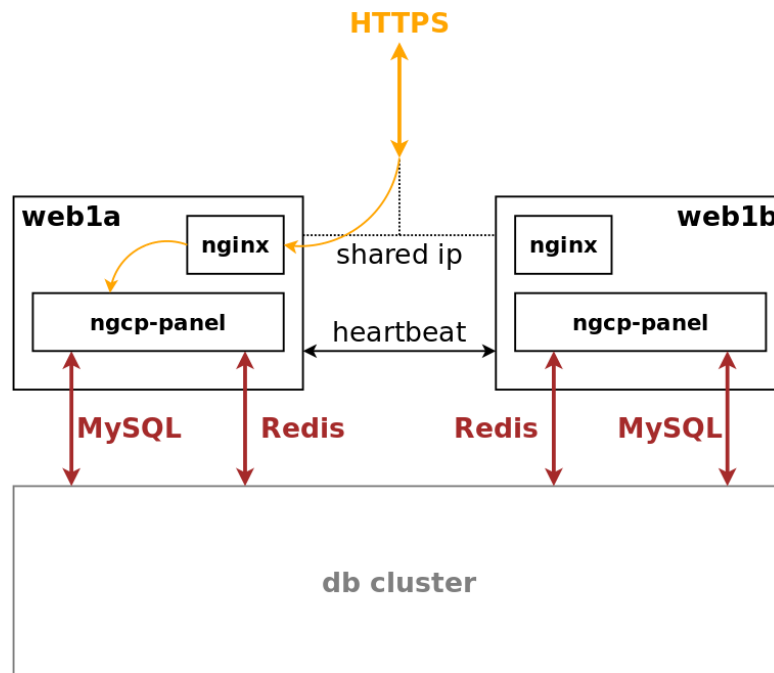

Figure 3: CARRIER Web Server Overview

The web server pair is an active/standby pair of nodes connected via an HA service (GCS/CRM). If one of the servers fail (by losing connection to the outside while the standby server is still connected, or caused by a hardware failure, or if it's down due to maintenance), the standby server takes over the shared IP address of the active node and continues serving the provisioning interface.

2.4 SIP Signaling and Media Relay

In SIP-based communication networks, it is important to understand that the signaling path (e.g. for call setup and tear-down) is completely independent of the media path. On the signaling path, the involved endpoints negotiate the call routing (which user calls which endpoint, and via which path - e.g. using SIP peerings or going through the PSTN - the call is established) as well as the media attributes (via which IPs/ports are media streams sent and which capabilities do these streams have - e.g. video using H.261 or Fax using T.38 or plain voice using G.711). Once the negotiation on signaling level is done, the endpoints start to send their media streams via the negotiated paths.

On a CARRIER any signalling traffic enters and leaves the system via load balancers, which act as a perimeter towards the customer devices and performs NAT handling, DoS and DDoS mitigation. New connections are routed to a random pair of proxy servers, which do the actual routing for SIP and XMPP. The proxy servers also engage media relays for voice and video streams, which bypass the load balancers and communicate directly with the customer devices for performance reasons.

The components involved in SIP and Media on the Sipwise C5 PRO/CARRIER are shown in the following figure:

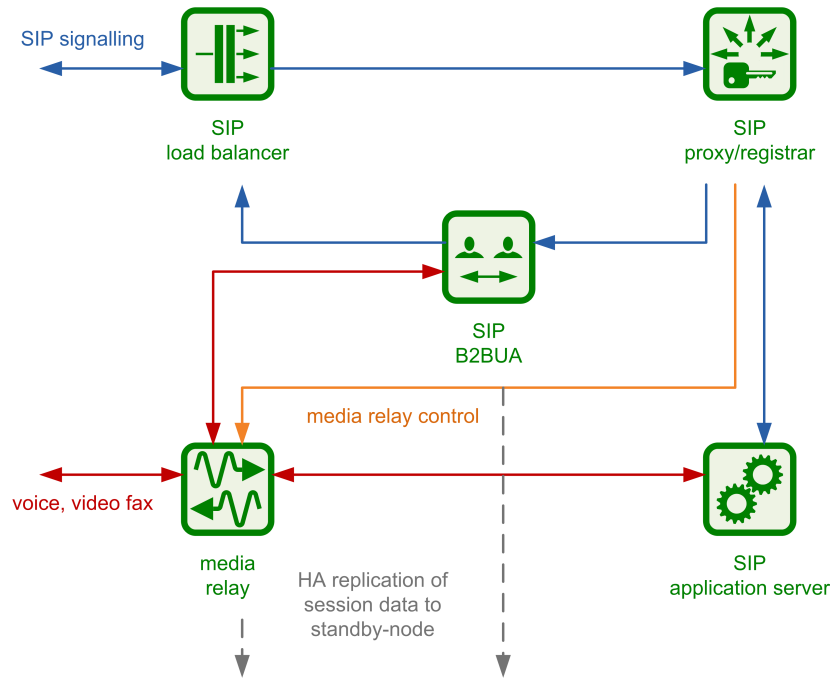

Figure 4: SIP and Media Relay Components

2.4.1 SIP Load-Balancer

The SIP load-balancer is a Kamailio instance acting as ingress and egress point for all SIP traffic to and from the system. It's a high-performance SIP proxy instance based on Kamailio and is responsible for sanity checks of inbound SIP traffic. It filters broken SIP messages, rejects loops and relay attempts and detects denial-of-service and brute-force attacks and gracefully handles them to protect the underlying SIP elements. It also performs the conversion of TLS to internal UDP and vice versa for secure signaling between endpoints and Sipwise C5, and does far-end NAT traversal in order to enable signaling through NAT devices.

The load-balancer is the only SIP element in the system which exposes a SIP interface to the public network. Its second leg binds in the switch-internal network to pass traffic from the public internet to the corresponding internal components.

The name load-balancer comes from the fact that when scaling out Sipwise C5 beyond just one pair of servers, the load-balancer instance becomes its own physical node and then handles multiple pairs of proxies behind it.

On the public interface, the load-balancer listens on port 5060 for UDP and TCP, as well as on 5061 for TLS connections. On the internal interface, it speaks SIP via UDP on port 5060 to the other system components, and listens for XMLRPC connections on TCP port 5060, which can be used to control the daemon.

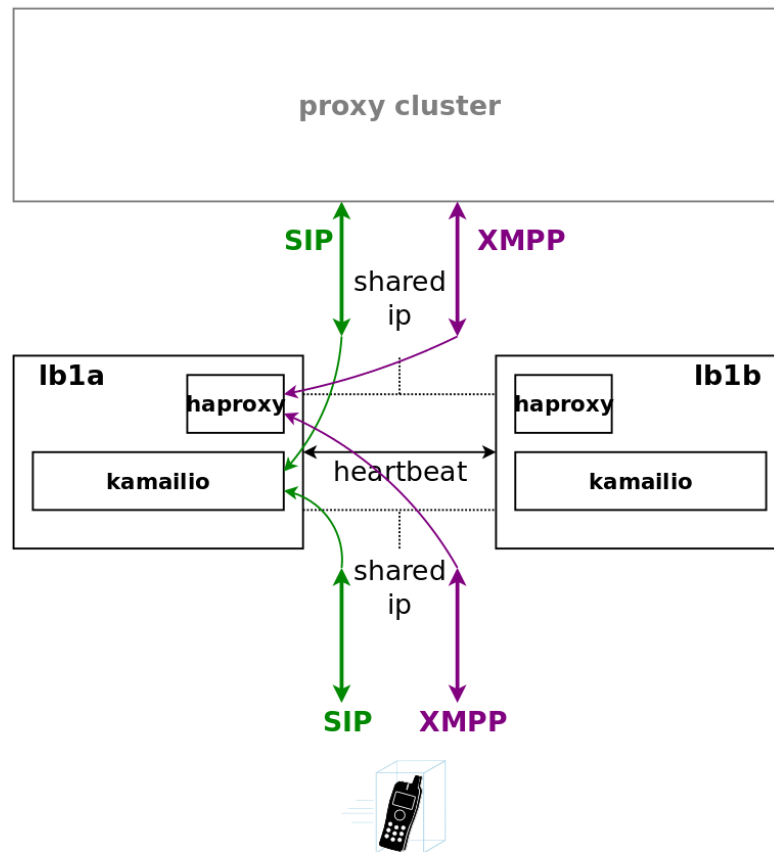

Figure 5: CARRIER Load Balancer Overview

A node in a load balancer pair runs two services besides the usual HA service.

One is a state-less instance of kamailio, providing an extremely fast relay of SIP messages. Kamailio takes care of converting TCP and TLS connections from the customer devices to UDP for internal communication towards proxies, and it performs far-end NAT traversal by inspecting the SIP messages and comparing it to the actual source address where packets have been received from, then modifying the SIP messages accordingly. If a SIP message is received by the load balancer, it distinguishes between new and ongoing SIP transactions by inspecting the To-Tags of a message, and it determines whether the message is part of an established dialog by inspecting the Route header. Sanity checks are performed on the headers to make sure the call flows adhere to certain rules for not being able to bypass any required element in the routing path. In-dialog messages are routed to the corresponding proxy servers according to the Route defined in the message. Messages initiating a new transaction and/or dialog (registrations, calls etc) are routed to a randomly selected proxy. The selection algorithm is based on a hash over the Call-ID of the message, so the same proxy sending a authentication challenge to an endpoint will receive the authenticated message again.

The second service running on a load balancer is haproxy, which is acting as load balancing instance for XMPP messages. The same way the SIP load balancer routes SIP messages to the corresponding proxy, the haproxy passes XMPP traffic on to the proxy maintaining a session with a subscriber, or randomly selects a proxy in case of a new connection while automatically failing over on timeouts.

Its config files reside in `/etc/ngcp-config/templates/etc/kamailio/lb/`, and changes to these files are applied by executing `ngcpcfg apply "my commit message"`.

Tip

The SIP load-balancer can be managed via the commands `ngcp-service start kamailio-lb`, `ngcp-service stop kamailio-lb` and `ngcp-service restart kamailio-lb`. Its status can be queried by executing `ngcp-service status kamailio-lb` or `ngcp-service summary | grep "kamailio-lb"`. Also `ngcp-kamctl lb` and `ngcp-kamcmd lb` are provided for querying kamailio functions, for example: `ngcp-kamcmd lb htable.dump ipban`. Execute the command: `ngcp-kamctl lb fifo system.listMethods` or `ngcp-kamcmd lb system.listMethods` to get the list of all available queries.

2.4.2 SIP Proxy/Registrar

The SIP proxy/registrar (or short *proxy*) is the work-horse of Sipwise C5. It's also a separate Kamailio instance running in the switch-internal network and is connected to the provisioning database via MySQL, authenticates the endpoints, handles their registrations on the system and does the call routing based on the provisioning data. For each call, the proxy looks up the provisioned features of both the calling and the called party (either subscriber or domain features if it's a local caller and/or callee, or peering features if it's from/to an external endpoint) and acts accordingly, e.g. by checking if the call is blocked, by placing call-forwards if applicable and by normalizing numbers into the appropriate format, depending on the source and destination of a call.

It also writes start- and stop-records for each call, which are then transformed into call detail records (CDR) by the mediation system.

If the endpoints indicate negotiation of one or more media streams, the proxy also interacts with the *Media Relay* to open, change and close port pairs for relaying media streams over Sipwise C5, which is especially important to traverse NAT.

The proxy listens on UDP port 5062 in the system-internal network. It cannot be reached directly from the outside, but only via the SIP load-balancer.

Its config files reside in `/etc/ngcp-config/templates/etc/kamailio/proxy/`, and changes to these files are applied by executing `ngcpcfg apply "my commit message"`.

Tip

The SIP proxy can be controlled via the commands `ngcp-service start kamailio-proxy`, `ngcp-service stop kamailio-proxy` and `ngcp-service restart kamailio-proxy`. Its status can be queried by executing `ngcp-service status kamailio-proxy` or `ngcp-service summary | grep "kamailio-proxy"`. Also `ngcp-kamctl proxy` and `ngcp-kamcmd proxy` are provided for querying kamailio functions, for example: `ngcp-kamctl proxy ul show`. Execute the command: `ngcp-kamctl proxy fifo system.listMethods` or `ngcp-kamcmd proxy system.listMethods` to get the list of all available queries.

2.4.3 SIP Back-to-Back User-Agent (B2BUA)

The SIP B2BUA (also called SBC within the system) decouples the first call-leg (calling party to Sipwise C5) from the second call-leg (Sipwise C5 to the called party).

The software part used for this element is a commercial version of SEMS, with the main difference to the open-source version that

it includes a replication module to share its call states with the stand-by node.

This element is typically optional in SIP systems, but it is always used for SIP calls (INVITE) that don't have Sipwise C5 as endpoint. It acts as application server for various scenarios (e.g. for feature provisioning via Vertical Service Codes and as Conferencing Server) and performs the B2BUA decoupling, topology hiding, caller information hiding, SIP header and Media feature filtering, outbound registration, outbound authentication, Prepaid accounting and call length limitation as well as Session Keep-Alive handler.

Due to the fact that typical SIP proxies (like the load-balancer and proxy in Sipwise C5) do only interfere with the content of SIP messages where it's necessary for the SIP routing, but otherwise leave the message intact as received from the endpoints, whereas the B2BUA creates a new call leg with a new SIP message from scratch towards the called party, SIP message sizes are reduced significantly by the B2BUA. This helps to bring the message size under 1500 bytes (which is a typical default value for the MTU size) when it leaves Sipwise C5. That way, chances of packet fragmentation are quite low, which reduces the risk of running into issues with low-cost SOHO routers at customer sides, which typically have problems with UDP packet fragmentation.

The SIP B2BUA only binds to the system-internal network and listens on UDP port 5080 for SIP messages from the load-balancer or the proxy, on UDP port 5040 for control messages from the cli tool and on TCP port 8090 for XMLRPC connections to control the daemon.

Its configuration files reside in `/etc/ngcp-config/templates/etc/ngcp-sems`, and changes to these files are applied by executing `ngcpcfg apply "my commit message"`.

Tip

The SIP B2BUA can be controlled via the commands `ngcp-service start sems`, `ngcp-service stop sems` and `ngcp-service restart sems`. Its status can be queried by executing `ngcp-service status sems` or `ngcp-service summary | grep "sems"`.

2.4.4 SIP App-Server

The SIP App-Server is an Asterisk instance used for voice applications like Voicemail and Reminder Calls. It is also used in the software-based Faxserver solution to transcode SIP and RTP into the IAX protocol and vice versa, in order to talk to the Software Fax Modems. Asterisk uses the MySQL database as a message spool for voicemail, so it doesn't directly access the file system for user data. The voicemail plugin is a slightly patched version based on Asterisk 1.4 to make Asterisk aware of Sipwise C5 internal UUIDs for each subscriber. That way a SIP subscriber can have multiple E164 phone numbers, but all of them terminate in the same voicebox.

The App-Server listens on the internal interface on UDP port 5070 for SIP messages and by default uses media ports in the range from UDP port 10000 to 20000.

The configuration files reside in `/etc/ngcp-config/templates/etc/asterisk`, and changes to these files are applied by executing `ngcpcfg apply "my commit message"`.

Tip

The SIP App-Server can be controlled via the commands `ngcp-service start asterisk`, `ngcp-service stop asterisk` and `ngcp-service restart asterisk`. Its status can be queried by executing `ngcp-service status asterisk` or `ngcp-service summary | grep "asterisk"`.

2.4.5 Message Routing and Media Relay

The Media Relay (also called *rtengine*) is a Kernel-based packet relay, which is controlled by the SIP proxy. For each media stream (e.g. a voice and/or video stream), it maintains a pair of ports in the range of port number 30000 to 40000. When the media streams are negotiated, *rtengine* opens the ports in user-space and starts relaying the packets to the addresses announced by the endpoints. If packets arrive from different source addresses than announced in the SDP body of the SIP message (e.g. in case of NAT), the source address is implicitly changed to the address the packets are received from. Once the call is established and the *rtengine* has received media packets from both endpoints for this call, the media stream is pushed into the kernel and is then handled by a custom Sipwise *iptables* module to increase the throughput of the system and to reduce the latency of media packets.

The *rtengine* internally listens on UDP port 12222 for control messages from the SIP proxy. For each media stream, it opens two pairs of UDP ports on the public interface in the range of 30000 and 40000 per default, one pair on even port numbers for the media data, and one pair on the next odd port numbers for metadata, e.g. RTCP in case of RTP streams. Each endpoint communicates with one dedicated port per media stream (opposed to some implementations which use one pair for both endpoints) to avoid issues in determining where to send a packet to. The *rtengine* also sets the QoS/ToS/DSCP field of each IP packet it sends to a configured value, 184 (0xB8, *expedited forwarding*) by default.

The kernel-internal part of the *rtengine* is facilitated through an *iptables* module having the target name `RTPENGINE`. If any additional firewall or packet filtering rules are installed, it is imperative that this rule remains untouched and stays in place. Otherwise, if the rule is removed from *iptables*, the kernel will not be able to forward the media packets and forwarding will fall back to the user-space daemon. The packets will still be forwarded normally, but performance will be much worse under those circumstances, which will be especially noticeable when a lot of media streams are active concurrently. See the section on *Firewalling* for more information.

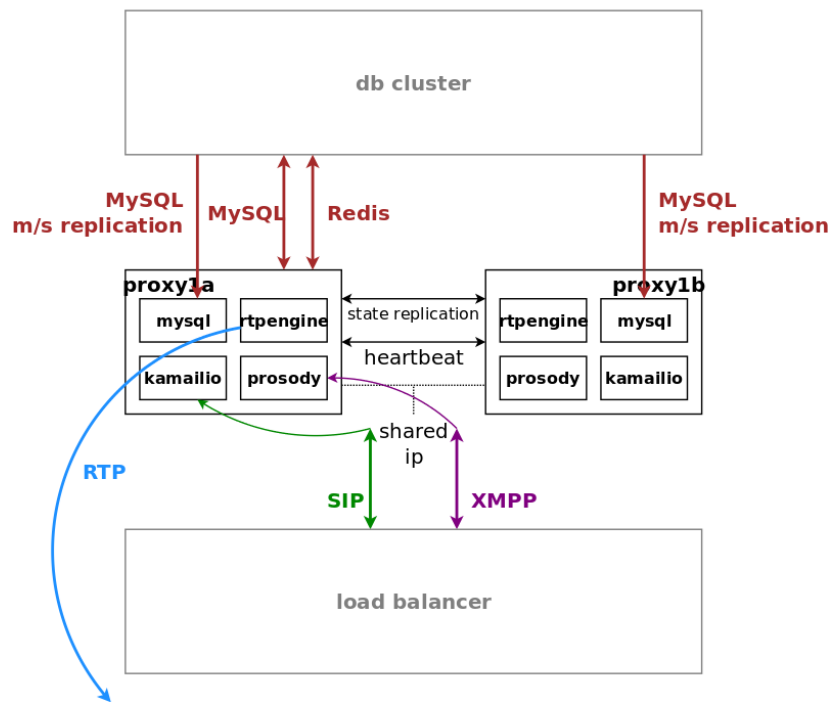

Figure 6: CARRIER Proxy Server Overview

Proxy servers also come in pairs, and by default there are four pairs of proxies in a standard Sipwise C5 CARRIER setup.

The proxies are responsible for doing the actual SIP routing and media handling and the XMPP presence and chat message deliveries. Each proxy pair can handle any subscriber on the overall system, compared to the concept of "home proxies" in other architectures. The advantage of this approach is that the overall system can be scaled extremely easily by adding more proxy pairs without having to redistribute subscribers.

Once a load balancer sends a new message to a proxy, the SIP transaction and/or dialog gets anchored to this proxy. That way it is ensured that a call starting on a proxy is also ended on the same proxy. Hence, the full range of feature handling like media relay, voicemail, fax, billing and rating is performed on this proxy. So, there is no a central point for various tasks, potentially leading to a non-scalable bottleneck. Due to the anchoring, proxies come in pairs and replicate all internal state information to the standby node via redis. In case of fail-over, the full signalling and media are moved to the standby node without interruption.

The complete static subscriber information like authentication credentials, number mappings, feature settings etc. are replicated from the db cluster down to the local MySQL instance of the proxies. The ratio of db read requests of static subscriber data versus reading and writing volatile and shared data is around 15:1, and this approach moves the majority of the static read operations from the central db cluster to the local proxy db.

Volatile and shared information needed by all proxies in the cluster is read from and written to the db cluster. This mainly includes SIP registration information and XMPP connection information.

Billing and rating is also performed locally on the proxies, and only completed CDRs (rated or unrated depending on whether rating is enabled) are transferred to the central db cluster for consumption via the northbound interfaces.

For SIP, the relevant instances on a proxy are kamailio acting as a stateful proxy for SIP registration and call routing, sems acting

as a back-to-back user-agent for prepaid billing and application server, rtpengine as media relay and RTP/SRTP transcoder, and asterisk as voicemail server. XMPP is handled by an instance of prosody, and several billing processes mediate start and stop records into CDRs and rate them according to the relevant billing profiles.

The rtpengine configuration file is `/etc/ngcp-config/templates/etc/default/ngcp-rtpengine-daemon`, and changes to this file are applied by executing `ngcpcfg apply "my commit message"`. The UDP port range can be configured via the `config.yml` file under the section `rtpproxy`. The QoS/ToS value can be changed via the key `qos.tos_rtp`.

Tip

The Media Relay can be controlled via the commands `ngcp-service start rtpengine`, `ngcp-service stop rtpengine` and `ngcp-service restart rtpengine`. Its status can be queried by executing `ngcp-service status rtpengine` or `ngcp-service summary | grep "rtpengine"`.

2.5 MySQL Database

The MySQL database consists of a pair of active/standby MySQL servers. They run a MySQL master/master replication with replication integrity checks to ensure data consistency and redundancy.

The MySQL servers on both physical nodes synchronize via the row-based master/master replication. In theory, any of the two servers in the pair can be used to write data to the database, however, in practice the shared IP address is used towards clients accessing the service, hence only the active MySQL server will receive the write requests and replicate them to the standby one.

2.5.1 Provisioning Database (CARRIER-only)

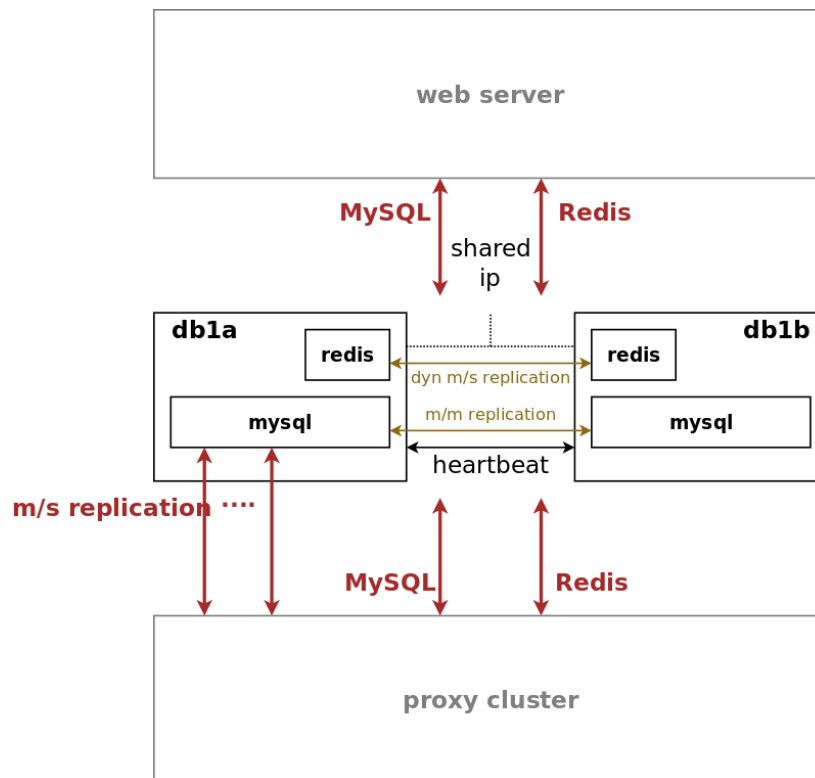

Figure 7: CARRIER DB Server Overview

The db server pair is another active/standby pair with automatic fail-over. Nodes in the pair are running a MySQL master/master replication with replication integrity checks to ensure data redundancy and safety. Any changes via provisioning interfaces are stored in the MySQL cluster. The second service is a redis master/slave replication with automatic master propagation on fail-over. This redis cluster is used as a high-performance volatile system cache for various components which need to share state information across nodes.

2.5.2 Persistent MySQL Database (CARRIER-only)

The MySQL instances on the db nodes synchronize via row-based master/master replication. In theory, any of the two servers in the pair can be used to write data to the database, however in practice a shared IP is used towards clients accessing the service, so only one node will receive the write requests. This is done to ensure transparent and instant convergence of the db cluster on fail-over for the clients.

On top of that, the first node of the db pair also acts as a master in a master/slave replication towards all proxy nodes in the system. That way, proxies can access read-only provisioning data directly from their local databases, resulting in reduced latency and significant off-loading of read queries on the central db cluster.

2.6 Redis Database

The redis database is used as a high-performance key/value storage for global system data shared across proxies. This includes calls information and concurrent calls counters for customers and subscribers, etc..

The active-standby replication ensures that the data is immediately copied from the active node to the standby one. As all sensitive call information is held in the shared storage, Sipwise C5 makes it possible to switch the operational state from active to standby on one physical node and from standby to active on the other node without any call interruptions. Your subscribers will never notice that their calls being established on one physical server, were successfully moved to another one and successfully completed there.

On a CARRIER a redis master/slave setup is used to provide a high-performance key/value storage for global system data shared across proxies. This includes concurrent call counters for customers and subscribers, as a subscriber could place two simultaneous calls via two different proxy pairs.

2.7 High Availability and Fail-Over

2.7.1 Overview

The two servers of a complete Sipwise C5 system form a pair, a simple cluster with two nodes. Their names are fixed as `sp1` and `sp2`, however neither of them is inherently a *first* or a *second*. They're both equal and identical and either can be the active node of the cluster at any time. Only one node is always ever active, the other one is in standby mode and does not perform any active functions.

High availability is achieved through constant communication between the two nodes and constant state replication from the active node to the standby one. Whenever the standby node detects that the other node has become unresponsive, has gone offline and has failed in any other way, it will proceed with taking over all resources and becoming the active node, with all operations resuming where the failed node has left off. Through that, the system will remain fully operational and service disruption will be minimal.

When the failed node comes back to life, it will become the new standby node, replicate everything that has changed in the meantime from the new active node, and then the cluster will be back in fully highly available state.

Tip

The login banner at the SSH shell provides information about whether the local system is currently the active one or the standby one. See Section [2.7.4](#) for other ways to differentiate between the active and the standby node.

2.7.2 Nomenclature and Alternatives

The HA architecture consists of two components: the Group Communication System, also known as *GCS*, and the Cluster Resource Manager, also known as *CRM*. Sipwise C5 supports two alternatives for these components:

1. Heartbeat version 2: This is the older and more basic software which provides both GCS and CRM services. It's still the default for Sipwise C5 installations but will be obsoleted in a future release.

2. Corosync/Pacemaker: This is the newer and more modern software and the successor of Heartbeat version 2. It splits the HA framework into its two components, with Corosync providing the GCS service and Pacemaker providing the CRM service. It provides several additional features over Heartbeat version 2 and will be made the default choice in a future release. See the Section 9 chapter for detailed information.

Caution

Because migration from a Heartbeat version 2 installation to a Corosync/Pacemaker installation requires installation and removal of certain software packages, a script `ngcp-migrate-ha-crm` is provided to automate this task. Rollback to Heartbeat version 2 is possible but requires manual intervention, therefore this should only be done with extreme caution.

2.7.3 Core Concepts and Configuration

The direct Ethernet crosslink between the two nodes provides the main mechanism of HA communication between them. All state replication happens over this link. Additionally, the GCS service uses this link to communicate with the other node to see if it's still alive and active. A break in this link will therefore result in a *split brain* scenario, with either node trying to become the active one. This is to be avoided at all costs.

The `config.yml` file allows specification of a list of *ping nodes* under the key `ha.pingnodes`, which are used by the CRM service to determine if local network communications are healthy. Both servers will then constantly compare the number of locally reachable ping nodes with each other, and if the standby server is able to reach more of them, then it will become the active one.

The main resource that the CRM service manages is the shared service IP address. Each node has its own static IP address configured on its first Ethernet interface (`eth0`), which is done outside of the Sipwise C5 configuration framework (i.e. in the Debian-specific config file `/etc/network/interfaces`). The shared service IP is specified in `network.yml` at the key `hosts.sp1|sp2.eth0.shared_ip`. The CRM service will configure it as a secondary IP address on the first Ethernet interface (`eth0:0`) on the active node and will deconfigure it on the standby node. Thus, all network communications with this IP address will always go only to the currently active node.

2.7.4 Administration

The current status of the local Sipwise C5 node can be determined using the `ngcp-check-active` shell command. This command produces no output, but returns an exit status of `0` for the active node and `1` for the standby node. A more complete shell command to produce visible output could be: `ngcp-check-active -v`

To force a currently active node into standby mode, use the command `ngcp-make-standby`. For the opposite effect, use the command `ngcp-make-active`. This will also always affect the state of the other node, as the system automatically makes sure that always only one node is active at a time.

3 Platform Deployment

This chapter will describe the hardware requirements of the Sipwise C5 platforms. And will provide the step by step instructions on how to put a PRO system into operation. There are currently no published instructions on how to put a CARRIER system into operation.

3.1 CARRIER Hardware Platform

3.1.1 Hardware Specifications

Sipwise C5 CARRIER starts with a minimum deployment of 50.000 subscribers, requiring one chassis with two web servers, two db servers, two load balancers and two proxies. A fully deployed Sipwise C5 CARRIER for 200.000 subscribers fills the chassis up with 14 servers, containing two web servers, two db servers, two load balancers and 8 proxies.



Figure 8: Hardware setup for single chassis

The system is based on an IBM Flex Chassis taking up rack space of 10U with 14 computing nodes based on IBM x240 servers.

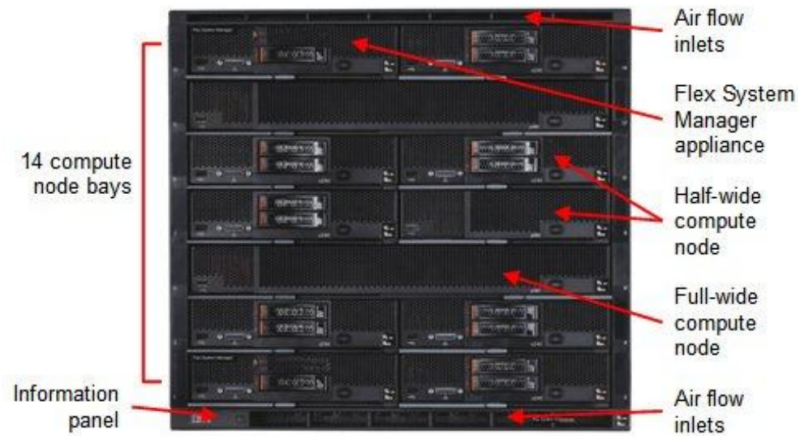

Figure 9: Chassis front view

All nodes are equipped equally with two hard disks in Raid-1 mode.

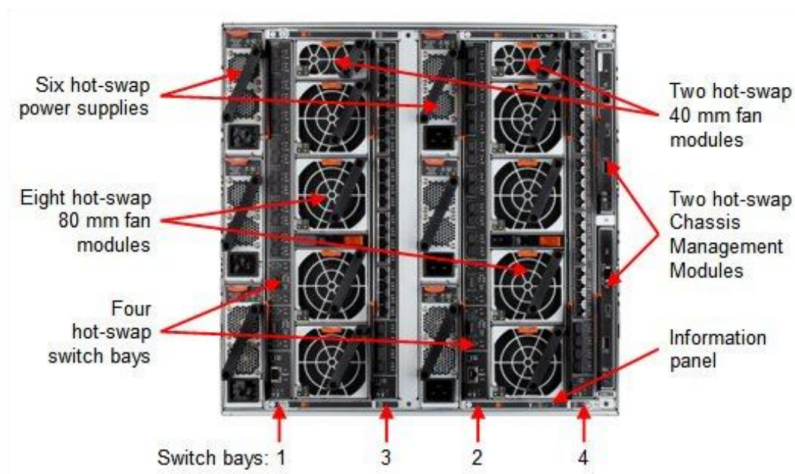

Figure 10: Chassis back view

The power supply is designed fully redundant in an N+N fashion with N=3, for example to feed 3 PSUs with normal power and 3 PSUs with UPS power.



Figure 11: Chassis switch module

Each chassis is equipped with two EN2092 Gigabit Ethernet switches providing 10 1GbE uplinks each. Four 10GbE uplinks are optional and need to be licensed separately if needed.

3.1.2 Scaling beyond one Hardware Chassis

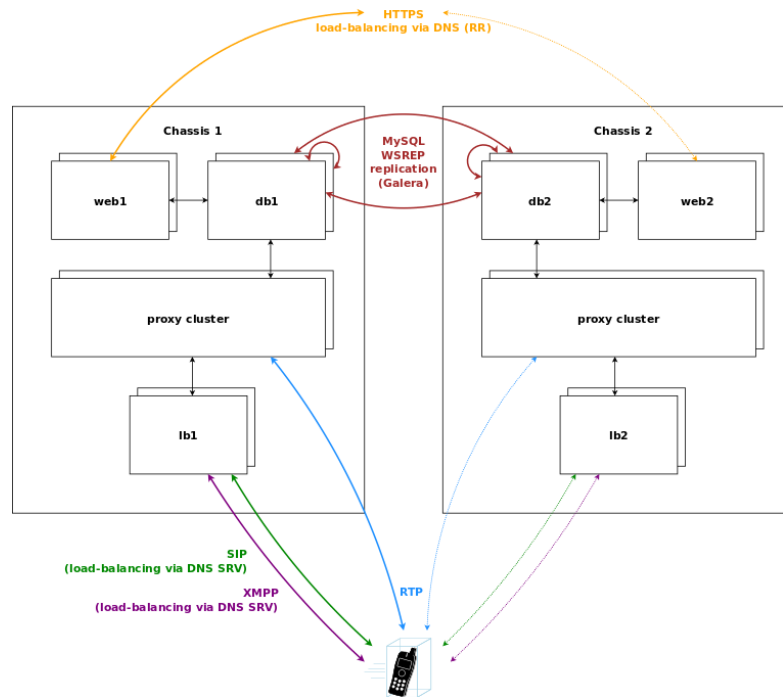

Figure 12: Scaling beyond one chassis

If Sipwise C5 CARRIER is scaled beyond 250.000 subscribers and therefore exceeds one chassis, a second chassis is put into place. This chassis provides another two web servers, two db servers, two load balancers and 8 proxies, doubling the capacity of the system.

3.1.2.1 Scaling the DB cluster

The DB cluster is the only node type which requires a notable change on the architecture. Once more than one db pair is deployed, the replication mechanism between db nodes changes from master/master between the nodes of the db1 pair to a synchronous multi-master replication over all db nodes on the system using Galera. This change makes it possible to scale both read and write requests over multiple nodes, while being transparent to all other nodes.

3.1.2.2 Scaling the proxy cluster

New proxy nodes replicate via master/slave from the first db node in the chassis as usual. Since the db cluster holds all provisioning information of all subscribers, the proxy nodes join the cluster transparently and will start serving subscribers as soon as all services on a new proxy are reachable from the load balancers.

3.1.2.3 Scaling the load balancers

Load balancers are completely stateless, so they start serving subscribers as soon as they are made visible to the subscribers. This could either be done via DNS round-robin, but the better approach is to configure a DNS SRV record, which allows for more fine-grained control like weighting load-balancer pairs and allowing fail-over from one pair to another on the client side.

The load balancers use the Path extension of SIP to make sure during SIP registration that calls targeted to a subscriber are routed via the same load balancer pair which the subscriber used during registration for proper traversal of symmetric NAT at the customer premise.

A SIP or XMPP request reaching a load balancer can be routed to any available proxy in the whole system, or only to proxies belonging to the same chassis as the load balancer, depending on the system configuration.

3.1.2.4 Scaling the web servers

New web server pairs are made available to web clients via DNS round-robin. Any pair of web servers can be used to read or write provisioning information via the web interfaces or the API.

3.1.3 Architecture for central core and local satellites

Tip

This architecture is not part of the standard deployment and is to be defined in the project plan!

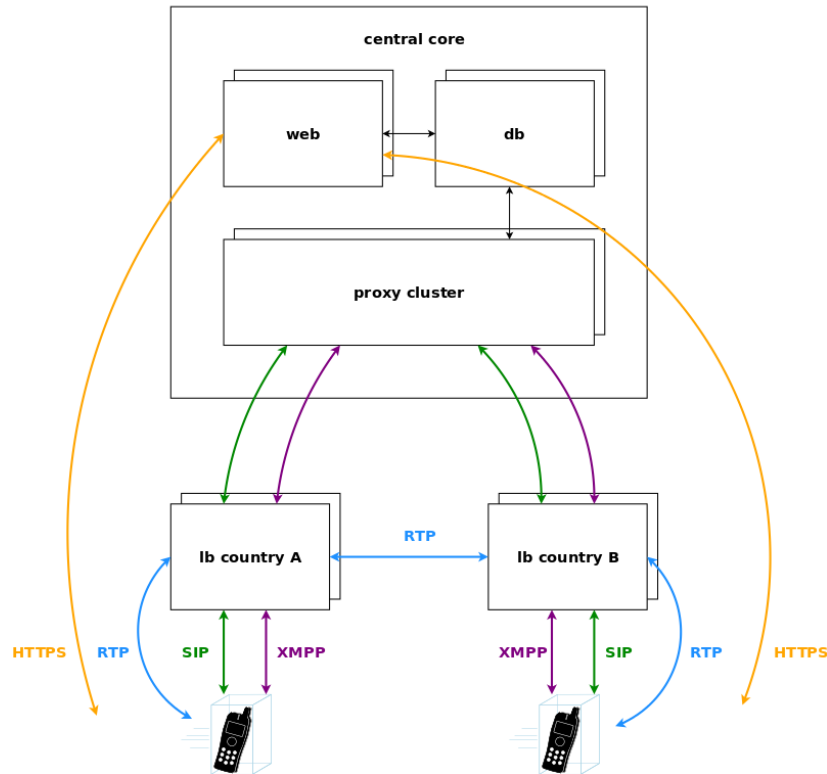

Figure 13: Central core with local breakouts

In case of a geographically distributed system spanning across multiple countries, different regulatory requirements have to be met for signalling and media, especially when it comes to if, where and how subscriber traffic can be intercepted. Countries might have the requirement to intercept traffic in the country, so the signalling and media must be anchored to an element in the country. Also if a media stream stays within a country, it is preferred to keep the media as close to the subscribers as possible to reduce latency, so relaying streams via a central core has to be avoided.

For this scenario, Sipwise C5 CARRIER makes it possible to move the load balancers directly into the countries. DNS settings for subscribers within the country ensure that they will always contact those load balancers, either using separate DNS settings per country for a SIP domain, or using GeoIP mechanisms in DNS to return the closest load balancer based on the location of the subscriber. To anchor media to the countries, the rtpengine instances are moved from the proxies to the load balancers and are controlled via the stateless kamailio instances on the load balancers instead of the kamailio instances on the proxies.

3.2 PRO Hardware Platform

3.2.1 Hardware Specifications

Sipwise provides Sipwise C5 platform fully pre-installed on two Dell PowerEdge R330 servers. Their most important characteristics are:

- Up to 8 pcs. of 2.5" storage drives (HDD or SSD); shipped with 4 drives installed and configured as RAID10 array

- Gbit Ethernet ports: 2 on-board and 2 additional ports (optional)
- iDRAC module for remote maintenance

Note

Please be aware that prior to Q3 2016 Sipwise used to provide its Sipwise C5 platform on older Dell PowerEdge server models: R310 and R320.

3.2.1.1 Dimensions and Weight

The hardware **dimensions** are defined in the following figure:

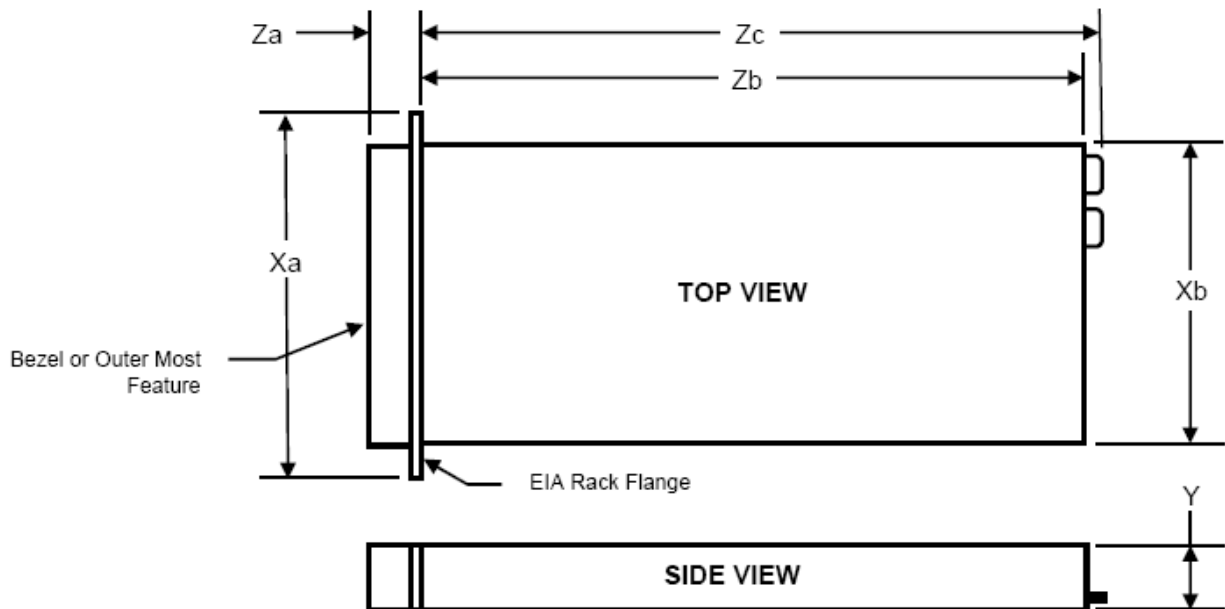

Xa	Xb (Width)	Y (Height)	Za w/ bezel	Za w/o bezel	Zb (Depth)	Zc
482.4mm	434mm	42.8mm	35mm	21mm	610mm	639.5mm

Weight of the server with storage drives and internal components installed: 13.4kg

3.2.1.2 Front View

The front view of a current Sipwise C5 **Dell R330** server:

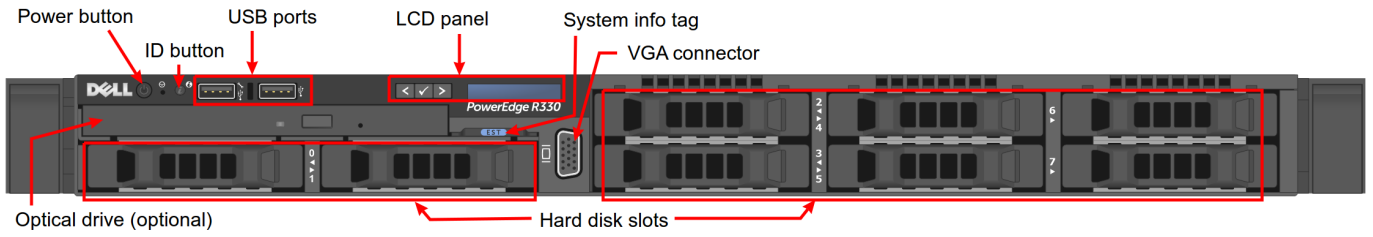

Figure 14: Dell R330 Front View

The front view of a former Sipwise C5 **Dell R310**. . . :

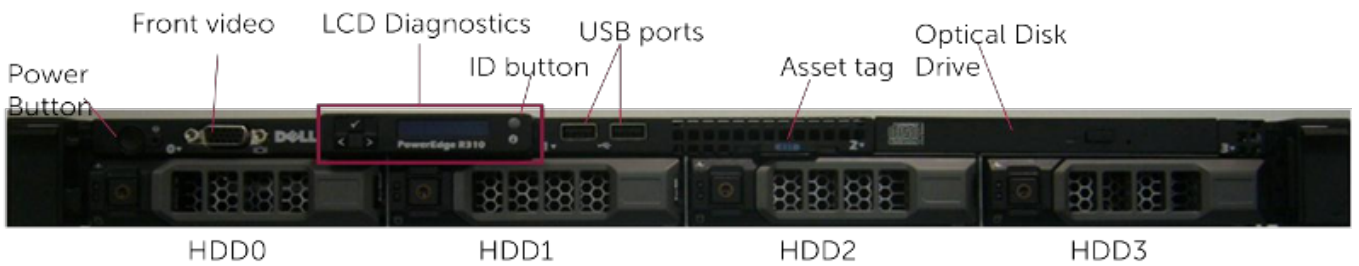

Figure 15: Dell R310 Front View

. . . and **Dell R320** server:

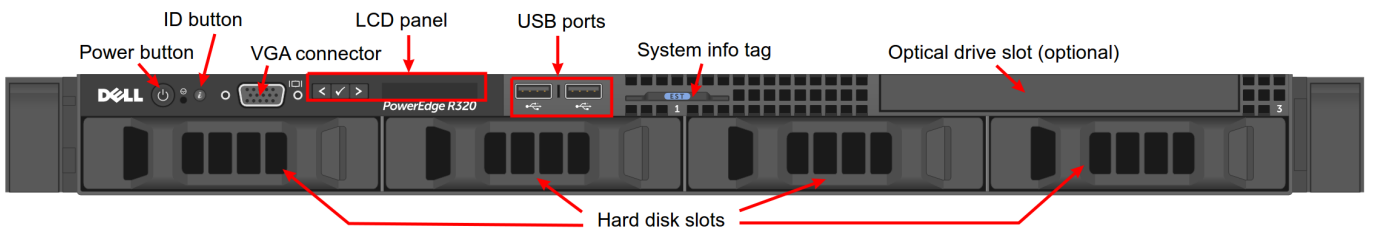

Figure 16: Dell R320 Front View

3.2.1.3 Rear View

The rear view of a current Sipwise C5 **Dell R330** server:

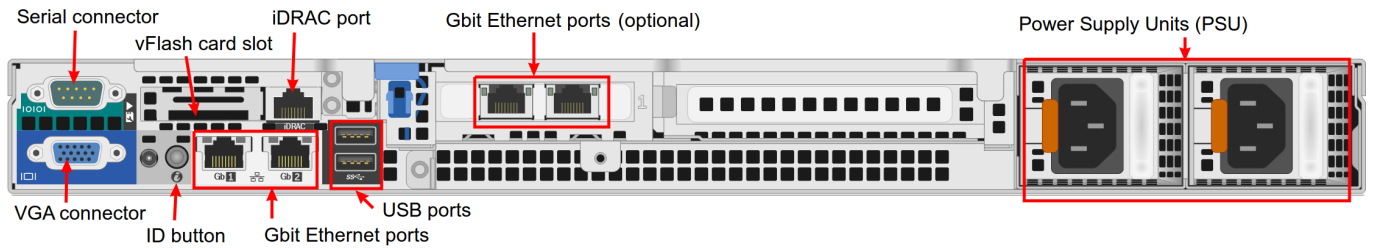

Figure 17: Dell R330 Rear View

The rear view of a former Sipwise C5 **Dell R310**...

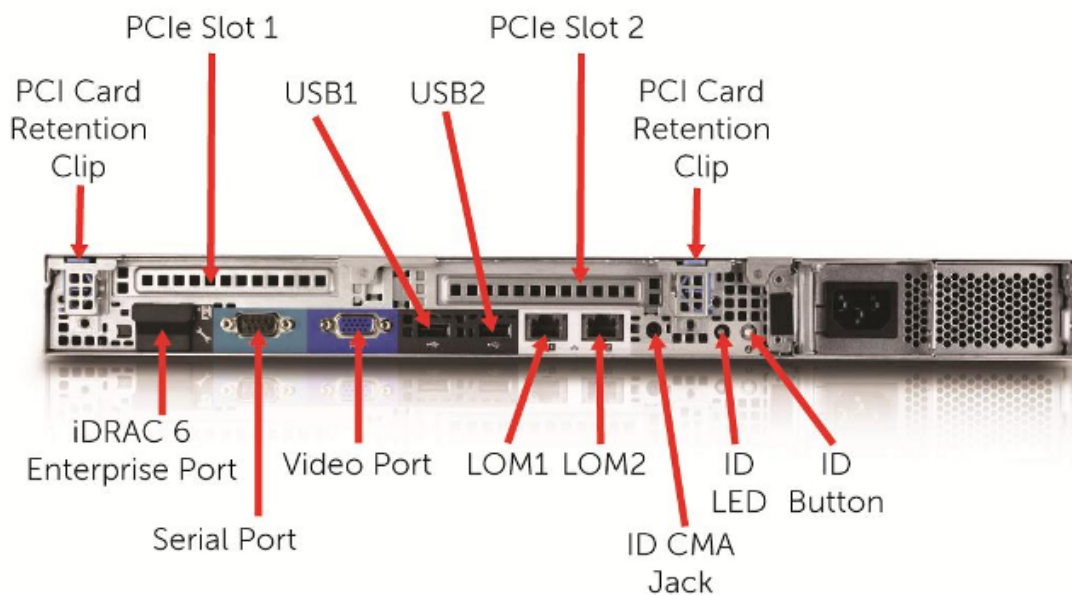

Figure 18: Dell R310 Rear View

... and **Dell R320** server:

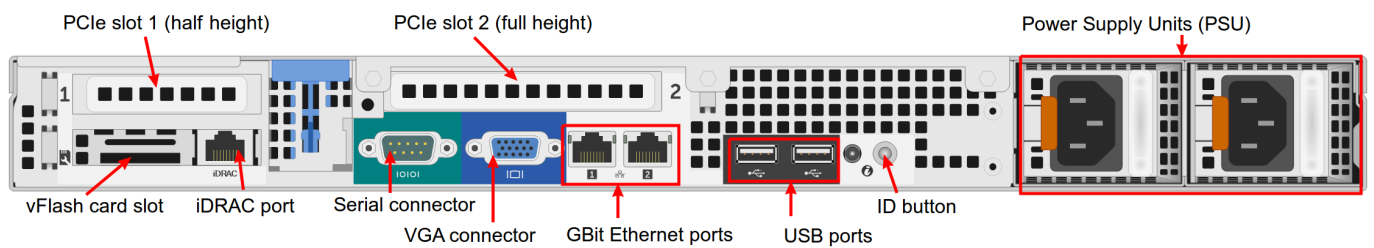

Figure 19: Dell R320 Rear View

3.2.1.4 Power Supply Units (PSU)

The servers are equipped with 2 redundant, hot-swappable PSUs, which are accessible from the rear side and located on the right of the chassis:



Figure 20: Redundant PSUs

The redundant PSUs include LEDs that indicate the status of the PSU:



Figure 21: PSU Indicators

- A. The indicator is solidly lit green: A valid power source is connected to the PSU and the PSU is operational.
- B. The indicator is flashing green: The PSU firmware is being updated.



Caution

Do not disconnect the power cord or unplug the PSU when updating the firmware. If a firmware update is interrupted, the PSUs will not function. You must roll back the PSU firmware by using Dell Lifecycle Controller. For more information, see Dell Lifecycle Controller User's Guide at Dell.com/idracmanuals.

- C. The indicator is flashing green and turns off: When hot-adding a PSU, the PSU handle flashes green five times at 4 Hz rate and turns off. This indicates that there is a PSU mismatch with respect to efficiency, feature set, health status, and supported voltage. Ensure that both the PSUs are the same.
- D. The indicator is flashing amber: Indicates a problem with the PSU.

**Caution**

When correcting a PSU mismatch, replace only the PSU with the flashing indicator. Swapping the other PSU to make a matched pair can result in an error condition and unexpected system shutdown. To change from a High Output configuration to a Low Output configuration or vice versa, you must turn off the system.

**Caution**

AC PSUs support both 220 V and 110 V input voltages with the exception of Titanium PSUs, which support only 220 V. When two identical PSUs receive different input voltages, they can output different wattages, and trigger a mismatch.

**Caution**

If two PSUs are used, they must be of the same type and have the same maximum output power.

**Caution**

Combining AC and DC PSUs is not supported and triggers a mismatch.

- E. The indicator is not lit: Power is not connected.

3.2.2 Installation Prerequisites

In order to put Sipwise C5 into operation, you need to rack-mount it into 19" racks.

You will find the following equipment in the box:

- 2 servers
- 2 pairs of rails to rack-mount the servers
- 2 cable management arms

You will additionally need the following parts as they are not part of the distribution:

- 4 power cables

Note

The exact type required depends on the location of installation, e.g. there are various forms of power outlets in different countries.

- At least 2 CAT5 cables to connect the servers to the access switches for external communication
- 1 CAT5 cable to directly connect the two servers for internal communication

3.2.3 Rack-Mount Installation

Install the two servers into the rack (either into a single one or into two geographically distributed ones).

The rails shipped with the servers fit into standard 4-Post 19" racks. If they do not fit, please consult your rack vendor to get proper rails.

The following figure shows the mounted rails:

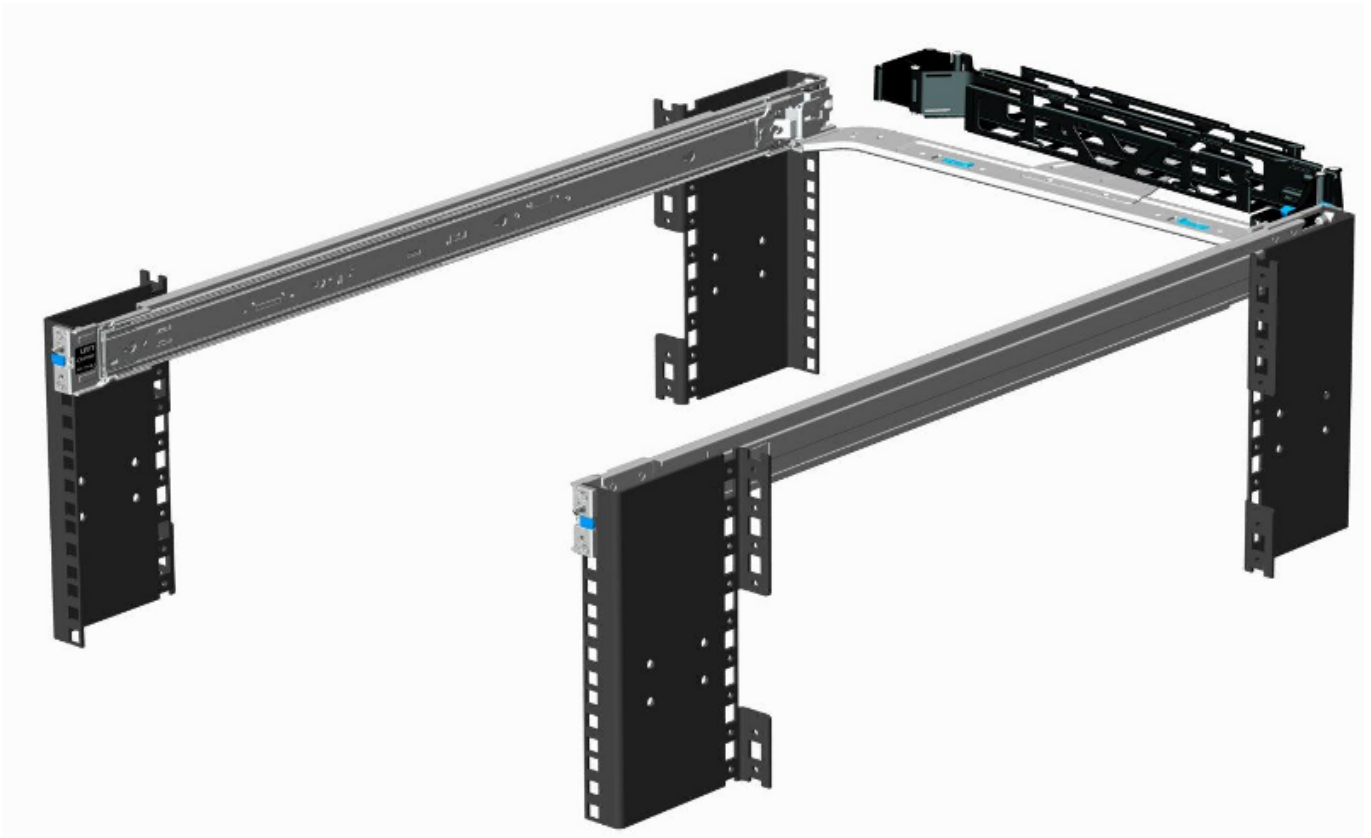

Figure 22: Rack-mounted Rails

3.2.4 Power Supply Cabling

Each server has two redundant Power Supply Units (PSU). Connect one PSU to your normal power circuit and the other one to an Uninterruptible Power Supply Unit (UPS) to gain the maximum protection against power failures.

The cabling should look like in the following picture to prevent accidental power cuts:



Figure 23: Proper PSU Cabling

3.2.5 Network Cabling

Internal Communication

The *high availability (HA)* feature of Sipwise C5 requires that a direct Ethernet connection between the servers is established. One of the network interfaces must be dedicated to this functionality.

External Communication

Remaining network interfaces may be used to make the servers publicly available for communication services (SIP, messaging, etc.) and also for their management and maintenance.

3.2.5.1 Internal Communication

Patch a cross-link with a straight CAT5 cable between the two servers by connecting the cable to the network interface assigned to the HA component by Sipwise. The direct cross cable is applied for maximum availability because this connection is used by the servers to communicate with each other internally.

**Important**

We strongly suggest against using a switch in between the servers for this internal interface. Using a switch is acceptable only if there is no another way to connect the two ports (e.g. if you configure a geographically distributed installation).

Note

In case you are using a switch for cross-link make sure to enable *portfast* mode on Cisco switches. The thing is that STP puts the port into learning mode for 90 seconds, after it comes up for the first time. During this learning phase, the link is technically up, but no traffic passes through, so the GCS service will detect the other node as dead during boot. The *portfast* mode tells the switch to skip the learning phase and go to forwarding state right away: `spanning-tree portfast [trunk]`.

3.2.5.2 External Communication

For both servers, depending on the network configuration, connect one or more straight CAT5 cables to the ports on the servers network cards and plug them into the corresponding switch ports. Information about proper ports of the servers to be used for this purpose are provided by Sipwise.

4 VoIP Service Administration Concepts

4.1 Contacts

A contact contains information such as the name, the postal and email addresses, and others. A contact's main purpose is to identify entities (resellers, customers, peers and subscribers) it is associated with.

A person or an organization may represent a few entities and it is handy to create a corresponding organization's contact beforehand and use it repeatedly when creating new entities. In this case we suggest populating the **External #** field to distinguish between customers associated with the same contact.

Reseller	Contact	Customer	External #
Default	Rylic Longstaff	DTS	0007
		Morning Times	0008
TelephOne	Clare Fenn	Lantern Co	—
	Ike Leonard	City Bank	—

Note that the only required contact field is **email**. For contacts associated with customers, it will be used for sending invoices and notifications such as password reset, new subscriber creation and others. A contact for a subscriber is created automatically but only if you specify an email address for this subscriber. It is mainly used to send notification messages, e.g. in case of a password reset.

4.2 Resellers

The reseller model allows you to expand your presence in the market by including virtual operators in the sales chain. A virtual operator can be a company without its own VoIP platform and even without a technical background, but with sales presence in a market. You define such a company as a reseller in the platform: grant limited access to the administrative web interface (the reseller administrator will only see his own customers, domains and billing profiles) and define wholesale rates for this reseller. Then, the reseller is free to operate under its own brand, make up its retail rates, establish the customer base and resell your services to its customers. The reseller's profit is a margin between the wholesale and retail rates.

Let us consider an example:

- You operate in Munich and provide residential and business services.
- A company Cheap Call that has a strong presence in Frankfurt offers to resell your services under its own brand in this city.
- You define wholesale rates for Cheap Call, such as calls to Argentina at €0,03.
- Cheap Call defines its retail price and offers calls to Argentina at €0,04.
- When one of Cheap Call's subscribers makes a 5-minute call to Argentina, this subscriber will be charged €0,20.
- You will get €0,15 revenue and Cheap Call's profit will be €0,20 - €0,15 = €0,05.

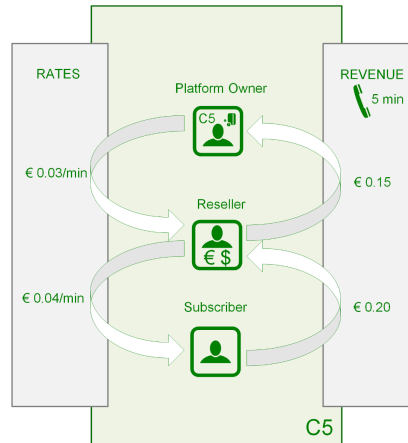

A reseller usually uses dedicated IP addresses or SIP domain names to provide services. Also, a reseller can rebrand the self-care web interface for its customers and select languages per SIP domain that allows the reseller to operate even in multiple countries.

4.3 SIP Domain

A SIP domain represents an external Internet address where your subscribers register their SIP phones to make calls or send messages. The SIP domain also contains particular default configuration for all the subscribers registered with this SIP domain. A SIP domain can be a regular FQDN (e.g. sip.yourdomain.com) or a NAPTR/SRV record. Using IP addresses for SIP domains in production is **strongly discouraged**.

4.3.1 Additional SIP Domains

You can create as many SIP domains as required to satisfy your networking or marketing requirements, e.g.:

- A dedicated SIP domain is *suggested* per CloudPBX customer.
- A separate SIP domain may be dedicated to every whitelabel reseller.
- Multiple SIP domains may be used to provide services in different countries or regions.
- Multiple SIP domains may be used to brand your own services.

Domain	Purpose
sip.yourdomain.com	Your own domain for retail customers
sip.enterprise.com	Your big customer with Cloud PBX
sip.reseller.com	Your white-label reseller
sip.yourdomain.de	Your domain for providing a new service in another country

4.4 Contracts

A contract is a combination of a *contact* and a *billing profile*, hence it represents a business contract for your resellers and peering partners.

Contracts can be created in advance on the *Reseller and Peering Contracts* page, or immediately during creation of a peer or a reseller.

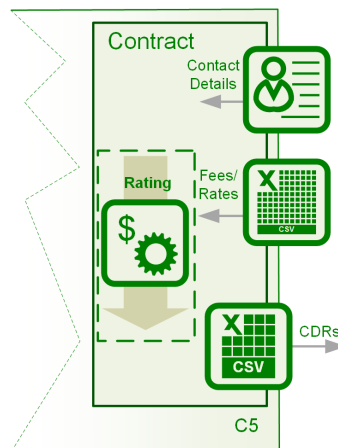

Note that the *customer* entity (described below) is a special type of the contract. A customer entity has an email and an invoice templates in addition to a contact and a billing profile.

4.5 Customers

A customer is a physical or legal entity whom you provide the VoIP service with and send invoices to. Here are the main features of a customer:

- Contains the contact and legal information. For example, an address or an email address for invoicing.
- Associated with a billing profile (to define fees per destination) and tracks the balance (used mostly for post-paid customers).
- Contains a certain number of subscribers who actually use the service and whose calls appear in the customer's list of CDRs.
- Provides some default parameters for all its subscribers. For example, voice prompts and call restriction.

Here are two common examples of the customer model:

4.5.1 Residential and SOHO customers

With this service you provide your residential and SOHO customers with one or multiple numbers and offer the service on a post-paid basis.

For a residential customer you usually create one *customer* entity with one *subscriber* under it. A residential customer can register multiple devices with the same number thus having a convenient Viber or Skype-like service: any device can be used to make a

call and all of them will ring simultaneously when there is an incoming call. At the end of the billing period, you send an invoice to the customer.

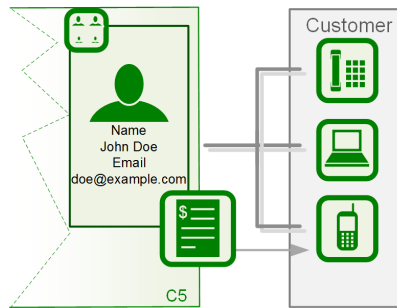

For SOHO customers you usually create multiple subscribers under the same customer and assign every subscriber a dedicated number to allow users make and receive calls. A common invoice will contain calls of all the subscribers.

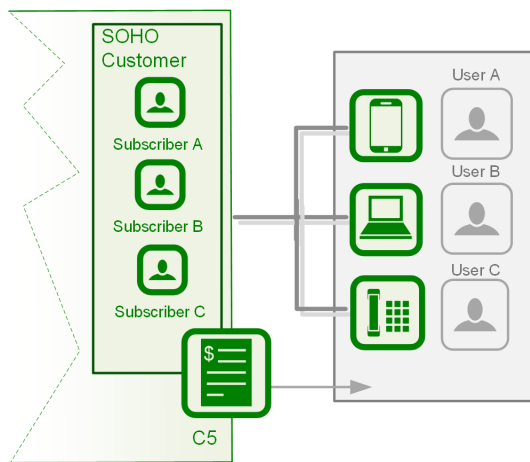

4.5.2 Business customers with the Cloud PBX service

In this case you create a Customer and all the required entities under it to reflect the company’s structure: subscribers, extensions, hunt groups, auto-attendant menus, etc.

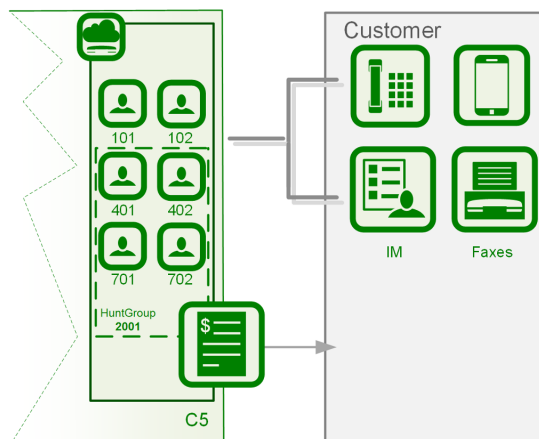

4.5.3 SIP Trunking

If a customer PBX can register itself with C5, you create a regular subscriber for it and configure a standard username/password authentication. Multiple PBX users can then send and receive calls.

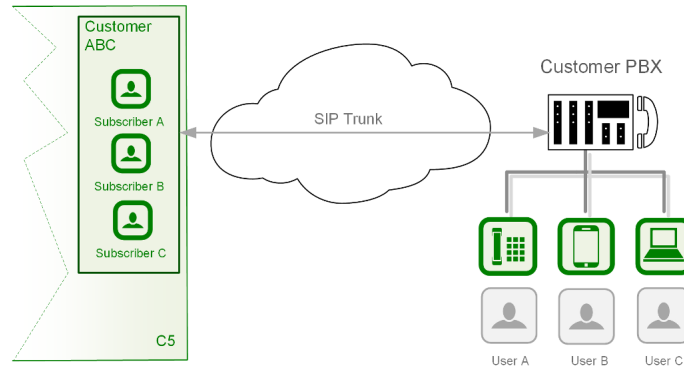

Legacy PBX devices that are not capable of passing the *challenge*-based authentication can be authenticated by the IP address. Optionally, every user of such a PBX can be authenticated separately by the FROM header and the IP address. For more details, refer to the [Trusted Sources](#) section.

4.5.4 Mobile subscribers

The pre-paid model works perfectly for **mobile application users**. In this case you generally create a single subscriber under a customer.

4.5.5 Pre-paid subscribers who use your calling cards

In this case you will most likely create a single subscriber under a customer, although multiple subscribers would work as well. In the latter case, they will share and top-up the common balance. Notice that the *customer* entity itself does not contain any technical configuration for the VoIP service authentication and instead contains other entities called *subscribers*, which do.

4.6 Subscribers

Every subscriber represents a SIP line or a SIP trunk. For example, in the residential services a subscriber entity is dedicated to every user. In the SIP trunking scenario, a subscriber can be used to authenticate all VoIP traffic from the remote PBX device.

In the following table logical subscriber types and their purpose are described.

Service	Subscriber Type	Purpose	Features
Residential	Regular subscriber	A regular VoIP service	Requires a DID number to receive calls from outside of your network
Enterprise (CloudPBX)	Pilot subscriber	A base number for the enterprise customer; Lists all extra numbers (aliases)	Configures the rest of customer subscribers in its self-care web interface

Service	Subscriber Type	Purpose	Features
	Extension	Extra numbers (DIDs, "implicit" extensions) for the enterprise customer	Can be dialed in different ways; The number configuration builds on top of the Pilot subscriber
	PBX Group	Forwards incoming calls to multiple extensions	Ringling policy defines in which order the extensions will ring
SIP Trunk	Digest authentication	Dynamically registers a remote IP PBX device	Handles multiple users behind the IP PBX device
	IP authentication	IP authentication of legacy IP PBX devices incapable of registering with the platform	Might require Trusted Subscriber and Trusted Source configuration
Prepaid	Regular subscriber with prepaid billing profile	Authorization of services based on customer balance; Disconnection of calls on "zero balance"	Vouchers and Balance Top-Up ; Billing Profile Packages

Tip

Subscriber **Aliases** can provide Extra DIDs or extension numbers to a subscriber.

4.7 SIP Peerings

A SIP peering is your interconnection with the external VoIP or PSTN network. Usually, a VoIP service provider has at least a few termination partners to offer its subscribers calls to virtually any landline and mobile destination.

SIP peerings also enable incoming calls to your platform. For example, if you rent a pool of DID numbers from a SIP peer and offer them to your residential and business customers.

An interconnection with your termination partners and DID number providers can include multiple servers and enable both out-bound and inbound calls, hence such a configuration is called a *SIP peering group*. You configure at least one SIP peering group for every partner and the main principle here is that all servers in a group terminate calls to the same set of listed destinations.

Any SIP peering group is associated with a *contract* for reconciliation and billing purposes and includes two main technical configurations:

- Peering Servers Represent connections to/from your SIP peering's network. The parameters include an IP address and/or a hostname of the remote part. For outbound calls, this is the destination address where to send calls to and for inbound calls it is an IP authorization of the remote server.
- Outbound/Inbound Peering Rules Outbound rules define through which SIP peering group a call from a specific subscriber will be sent for termination to a specific destination.

The example below shows four SIP peering groups with different priorities, callee prefixes (actual destinations offered by this SIP peering) and callee / called patterns (fine-tuning which callee request URIs and caller URIs are allowed through this SIP peering group).

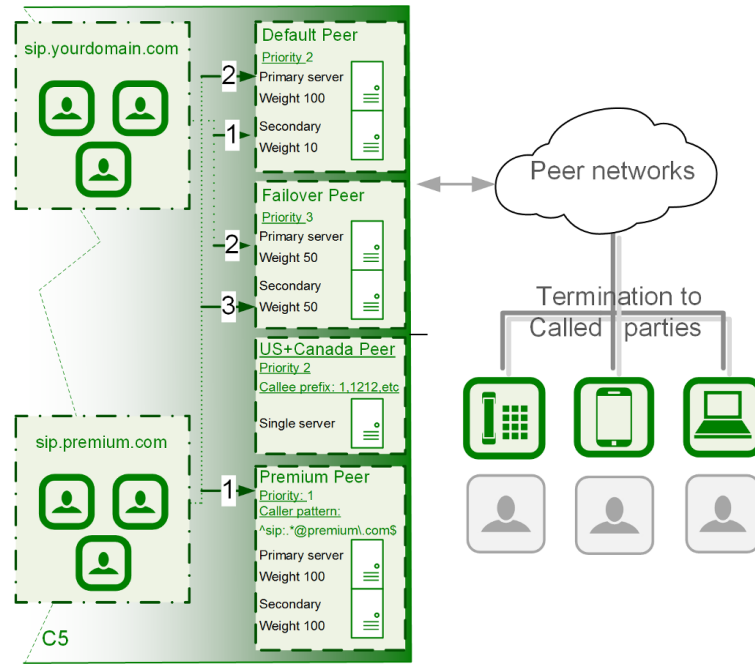

The figure shows how calls from premium subscribers can in the first place be routed through a dedicated SIP peering group unavailable to regular subscribers.

See the [Routing Order Selection](#) section for details about call routing.

Inbound rules allow [filtering out incoming INVITE requests](#) arriving from the corresponding SIP peering servers.

5 VoIP Service Configuration Scenario

A basic VoIP service configuration is fast, easy and straight-forward. Provided that your network and required DNS records have been preconfigured, the configuration of a VoIP service can be done purely via the administrative web interface. The configuration mainly includes the following steps:

- Reseller creation (optional)
- SIP domain configuration
- Customer creation
- Subscribers provisioning

Let us assume you are using the *1.2.3.4* IP address with an associated *sip.yourdomain.com* domain to provision VoIP services. This allows you to provide an easy-to-remember domain name instead of the IP address as the proxy server. Also, your subscribers' URIs will look like *1234567@sip.yourdomain.com*.

Tip

Using an IP address instead of an associated FQDN (domain name) for a SIP domain is not suggested as it could add extra administrative work if you decide to relocate your servers to another datacenter or just change IP addresses.

Go to the *Administrative Web Panel (Admin Panel)* running on *https://<ip>:1443/login/admin* and follow the steps below. The default web panel user and password are *administrator*, if you have not already changed it.

5.1 Creating a SIP Domain

A SIP domain is a connection point for your subscribers. The SIP domain also contains specific default configuration for all its subscribers.

Tip

Thoroughly plan your domain names policy in advance and take into account that: 1) the name of a SIP domain cannot be changed after creating it in the administrative web panel; 2) subscribers cannot be moved from one domain to another and must be recreated.

To create a SIP domain, follow these steps:

1. Firstly, configure an FQDN on your DNS server for it.

The domain name must point to the physical IP address you are going to use for providing the VoIP service. A good approach is to create an SRV record:

```
SIP via UDP on port 5060
SIP via TCP on port 5060
SIP via TCP/TLS on port 5061
```

2. Create a new SIP domain in the administrative web panel.

Go to the *Domains* page and create a new SIP Domain using the FQDN created above.

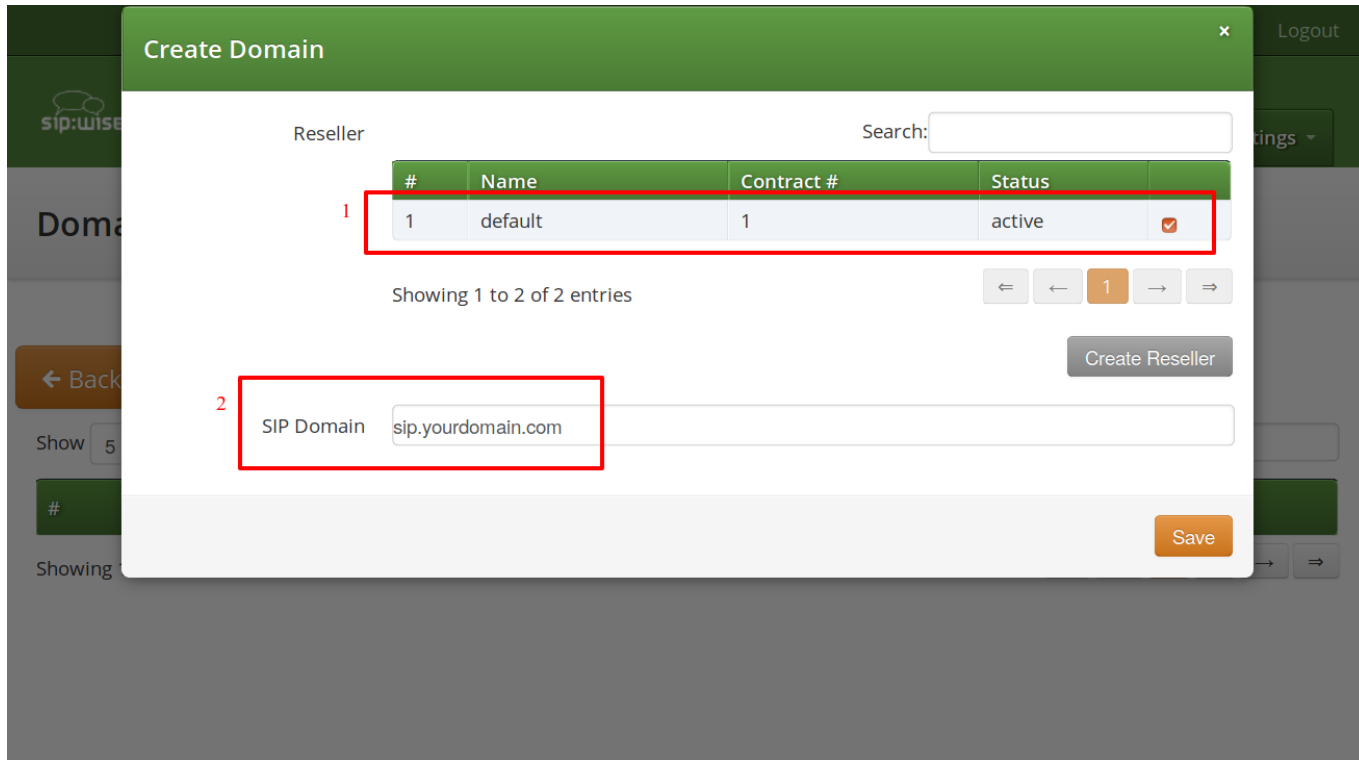

Select a *Reseller* who will own the subscribers in this SIP domain. Use the *default* virtual reseller if you provide services directly. Enter your SIP domain name and press *Save*.

3. Adjust the new SIP domain's preferences if necessary.

You can create multiple SIP domains reusing the existing IP address or adding a new one. Extra SIP domains are required e.g. if you would like to host a virtual operator on your platform, create separate domains for providing services in different countries or just offer a new service.

5.2 Creating a Customer

A Customer is a special type of contract acting as legal and billing information container for SIP subscribers. A customer can have one or more SIP subscriber entities that represent SIP lines.

Tip

For correct billing, notification and invoicing, create a customer with a single SIP subscriber for the residential service (as it normally has only one telephone line) and a customer with multiple SIP subscribers to provide a service to a company with many telephone lines.

To create a Customer, go to *Settings*→*Customers*.

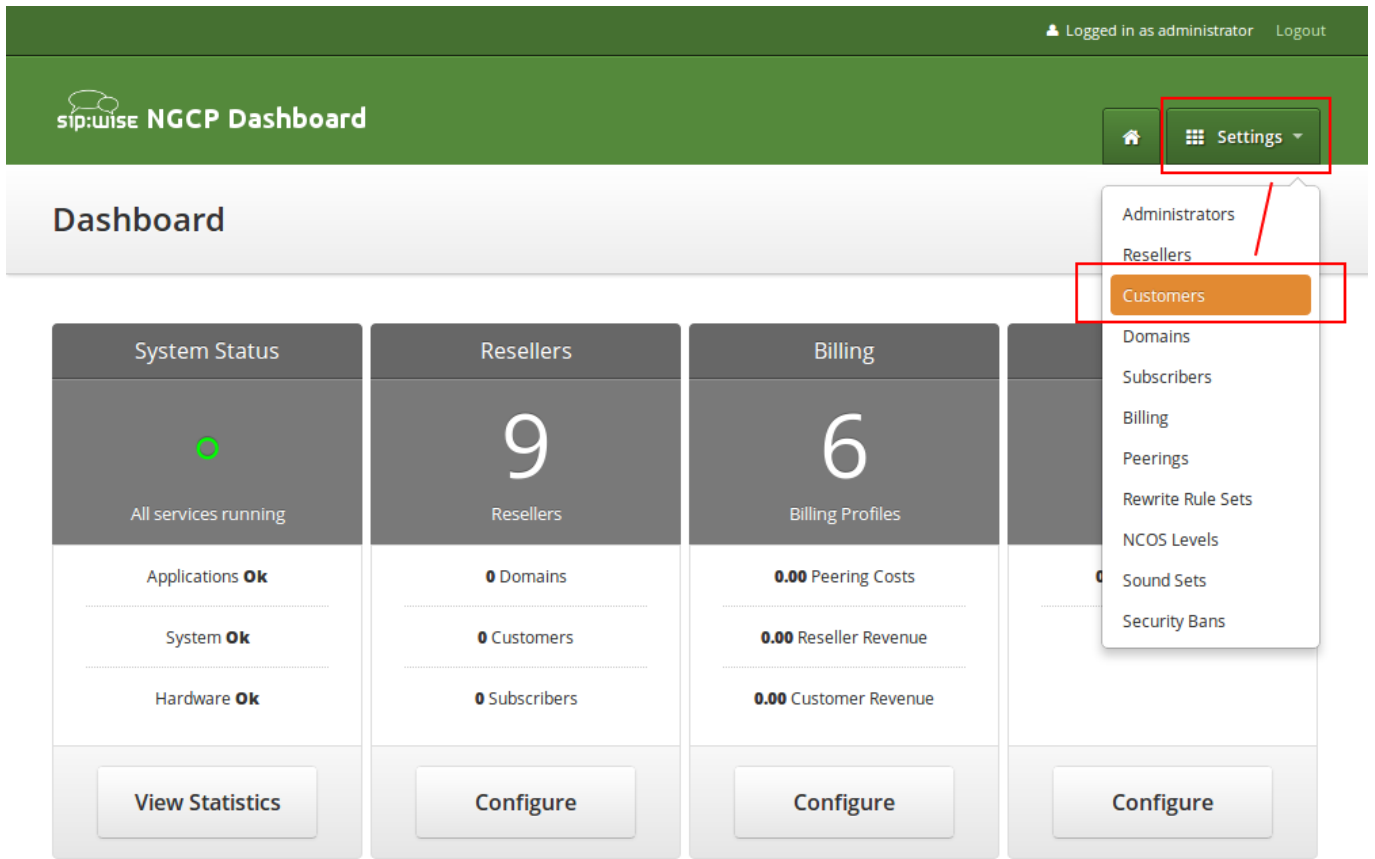

Click on *Create Customer*.

Logged in as administrator Logout

sip:wise NGCP Dashboard

Home Settings

Customers

← Back ★ Create Customer

Search:

#	External #	Reseller	Contact Email	Billing Profile	Status
No data available in table					

Showing 0 to 0 of 0 entries

© 2013 Sipwise GmbH, all rights reserved.

Each *Customer* has a *Contact*—a container for the personal and legal information that identifies a private or corporate customer.

Tip

Create a dedicated *Contact* for every *Customer* as it contains specific data e.g. name, address and IBAN that identifies this customer.

Click on *Create Contact* to create a new *Contact*.

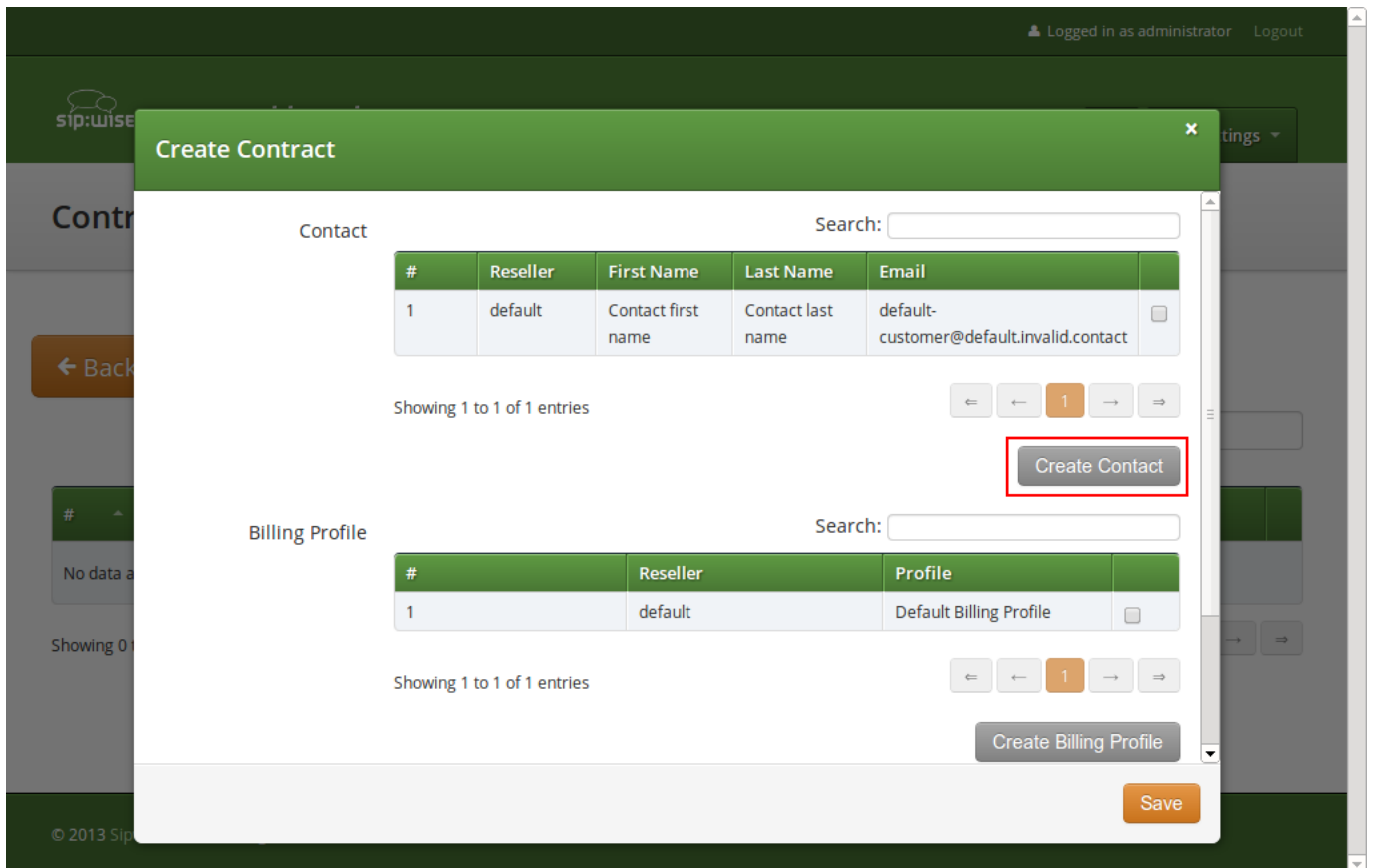

Select the required *Reseller* and enter the contact details (at least an *Email* is required), then press *Save*.

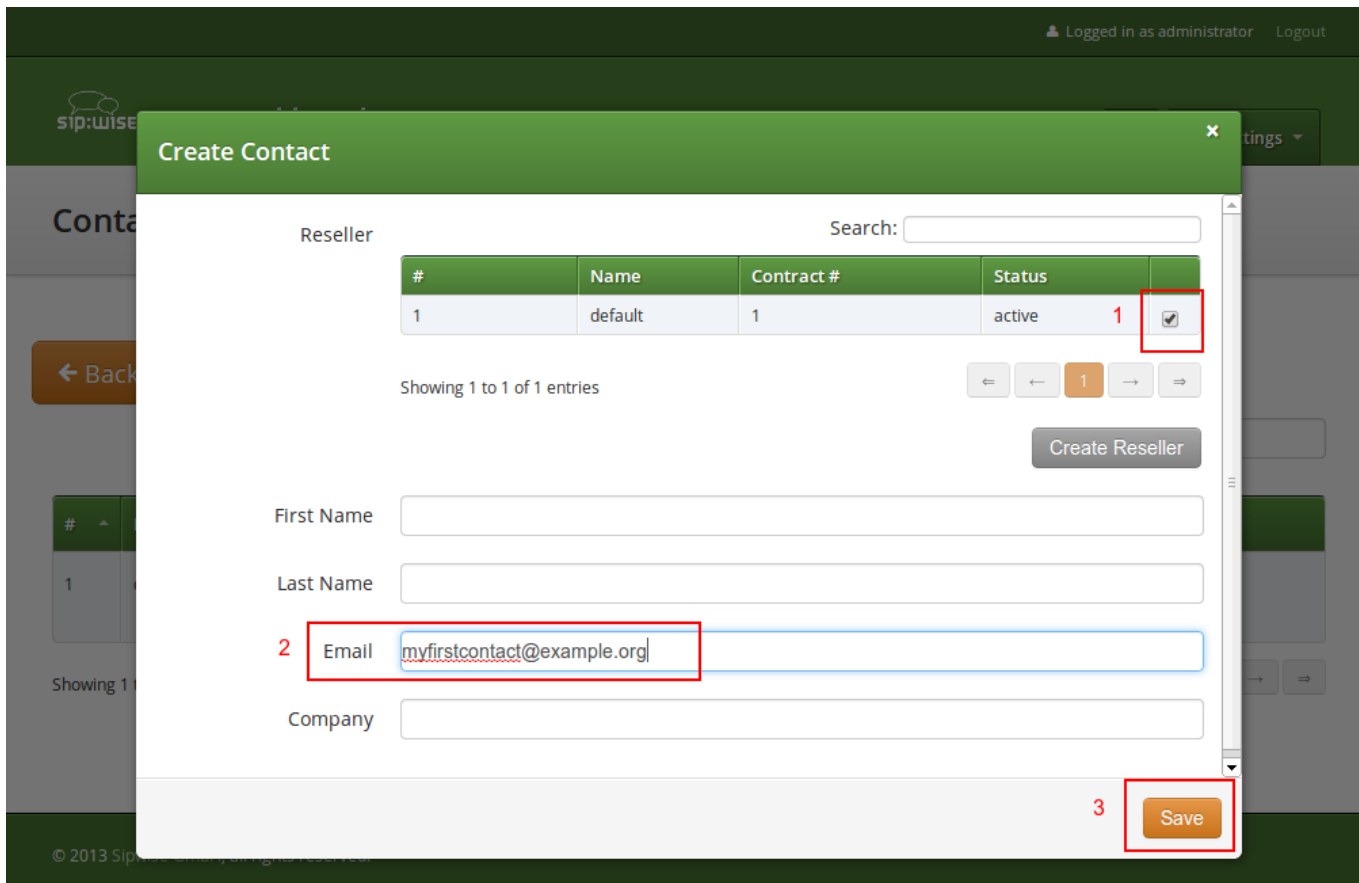

You will be redirected back to the *Customer* form. The newly created *Contact* is selected by default now, so only select a *Billing Profile* and press *Save*.

You will now see your first *Customer* in the list. Hover over the customer and click *Details* to make extra configuration if necessary.

Logged in as administrator Logout

sip:wise NGCP Dashboard Home Settings

Customers

[← Back](#) [★ Create Customer](#)

Contract successfully created

Search:

#	External #	Reseller	Contact Email	Billing Profile	Status	
20		default	myfirstcontact@example.org	Default Billing Profile	active	Edit Terminate Details

Showing 1 to 1 of 1 entries ← 1 →

5.3 Creating a Subscriber

In your *Customer* details view, click on the *Subscribers* row, then click *Create Subscriber*.

Logged in as administrator Logout

sip:wise NGCP Dashboard

Home Settings

Customer Details

← Back Edit

Reseller

Contact Details

Billing Profiles

1 Subscribers

★ Create Subscriber 2

SIP URI	Primary Number	Registered Devices
---------	----------------	--------------------

Contract Balance

Select a *SIP Domain* created earlier and specify required and optional parameters:

- **Domain:** The domain part of the SIP URI for your subscriber.
- **E164 Number:** This is the telephone number mapped to the subscriber, separated into *Country Code (CC)*, *Area Code (AC)* and *Subscriber Number (SN)*. For the first tests, you can set an imaginary number here and change it later when you get number blocks assigned by your PSTN interconnect partner. So in our example, we'll use *43* as CC, *99* as AC and *1001* as SN to form the imaginary number *+43 99 1001*.

Tip

This number can actually be used to place calls between local subscribers, even if you don't have any PSTN interconnection. This comes in handy if you use phones instead of soft-clients for your tests. The format in which this number can be dialled, so the subscriber is reached is defined in Section 5.7.

Important



Sipwise C5 allows a single subscriber to have multiple E.164 numbers to be used as aliases for receiving incoming calls. Also, Sipwise C5 supports so-called "implicit" extensions. If a subscriber has phone number 012345, but somebody calls 012345100, then NGCP first tries to send the call to number 012345100 (even though the user is registered as 012345). If Sipwise C5 then receives the 404 - Not Found response, it falls back to 012345 (the user-part with which the callee is registered).

- **Email:** An email address for sending service-related notifications to.
- **Web Username:** This is the user part of the username the subscriber may use to log into her *Customer Self Care Interface*. The user part will be automatically suffixed by the SIP domain you choose for the **SIP URI**. Usually, the web username is identical to the **SIP URI**, but you may choose a different naming schema.

**Caution**

The web username needs to be unique. The system will return a fault if you try to use the same web username twice.

- **Web Password:** This is the password for the subscriber to log into her *Customer Self Care Interface*. It must be at least 6 characters long.
- **SIP Username:** The user part of the SIP URI for your subscriber.
- **SIP Password:** The password of your subscriber to authenticate on the SIP proxy. It must be at least 6 characters long.
- **Status:** You can lock a subscriber here, but for creating one, you will most certainly want to use the *active* status.
- **External ID:** You can provision an arbitrary string here (e.g. an ID of a 3rd party provisioning/billing system).
- **Administrative:** If you have multiple subscribers in one account and set this option for one of them, this subscriber can administrate other subscribers via the *Customer Self Care Interface*.

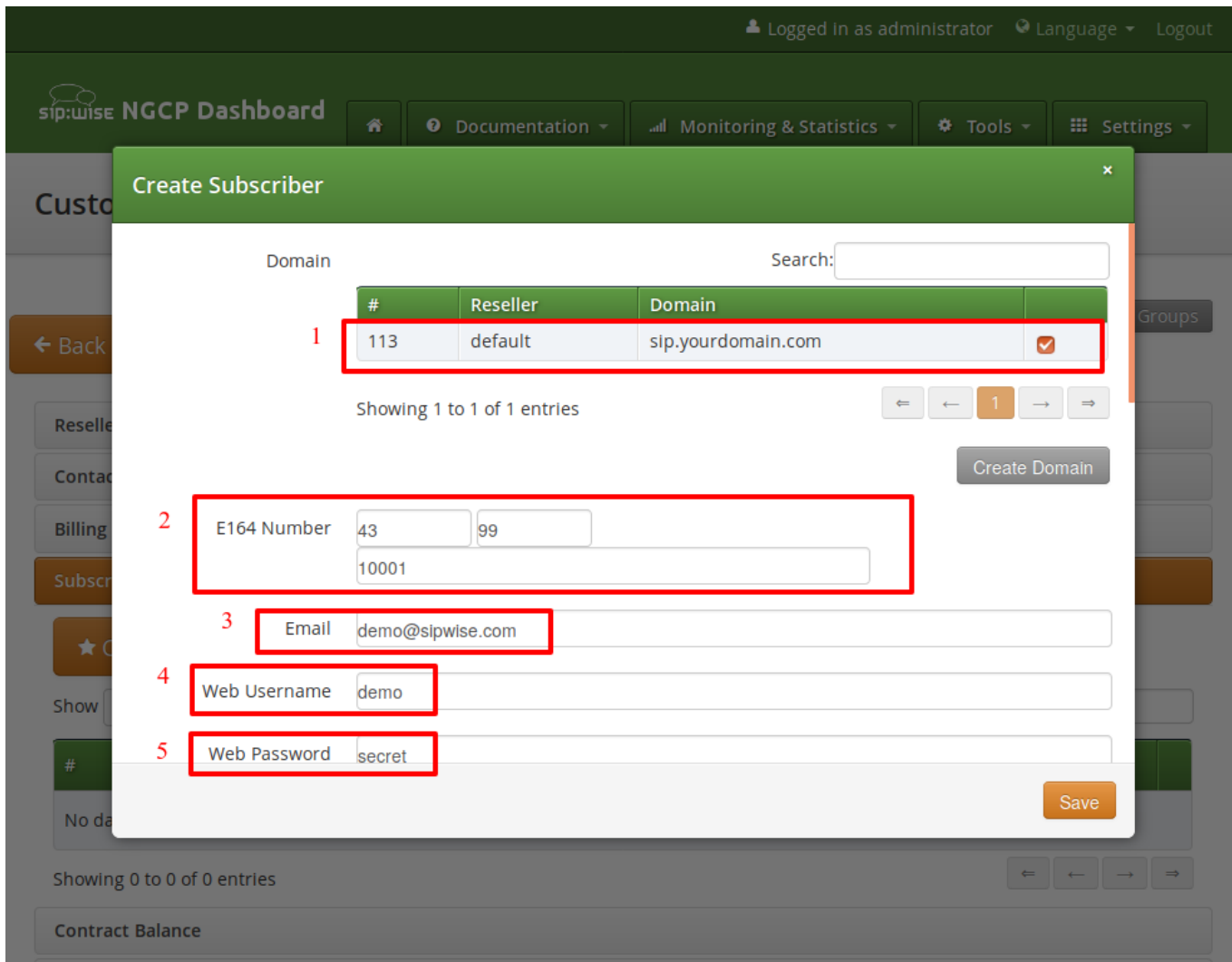

The screenshot shows the 'Create Subscriber' form in the Sipwise NGCP Dashboard. The form is a modal window with a green header. It contains the following fields:

- Web Username: demo
- Web Password: secret
- SIP Username: demo (highlighted with a red box and labeled '6')
- SIP Password: 1secret! (highlighted with a red box and labeled '7')
- Lock Level: none
- Status: active
- External ID: demo
- Administrative:

A 'Save' button is located at the bottom right of the form. The background shows the dashboard navigation menu with options like 'Documentation', 'Monitoring & Statistics', 'Tools', and 'Settings'.

Repeat the creation of *Customers* and *Subscribers* for all your test accounts. You should have at least 3 subscribers to test the functionality of the NGCP.

Tip

At this point, you're able to register your subscribers to Sipwise C5 and place calls between these subscribers.

You should now revise the *Domain* and *Subscriber Preferences*.

5.4 Domain Preferences

The *Domain Preferences* are the default settings for *Subscriber Preferences*, so you should set proper values there if you don't want to configure each subscriber separately. You can later override these settings in the *Subscriber Preferences* if particular subscribers need special settings. To configure your *Domain Preferences*, go to *Settings*→*Domains* and click on the *Preferences* button of the domain you want to configure.

Logged In as administrator Language Logout

Sipwise NGCP Dashboard Documentation Monitoring & Statistics Tools Settings

Domains

← Back ★ Create Domain

Show 5 entries Search:

#	Reseller	Domain	
113	default	sip.yourdomain.com	Delete Preferences

Showing 1 to 1 of 1 entries

The most important settings are in the *Number Manipulations* group.

Here you can configure the following:

- for incoming calls - which SIP message headers to take numbers from
- for outgoing calls - where in the SIP messages to put certain numbers to
- for both - how these numbers are normalized to E164 format and vice versa

To assign a *Rewrite Rule Set* to a *Domain*, create a set first as described in Section 5.7, then assign it to the domain by editing the `rewrite_rule_set` preference.

Domain "sip.yourdomain.com" - Preferences

← Back

Call Blockings

Access Restrictions

1 Number Manipulations

	Name	Value	
?	rewrite_rule_set	<input type="text" value=""/>	2 <input type="button" value="Edit"/>
?	extension_in_npn	<input type="checkbox"/>	
?	inbound_upn	<input type="text" value="From-Username"/>	
?	outbound_from_user	<input type="text" value="User-Provided-Number"/>	
?	outbound_from_display	<input type="text" value="None"/>	

Select the *Rewrite Rule Set* and press *Save*.

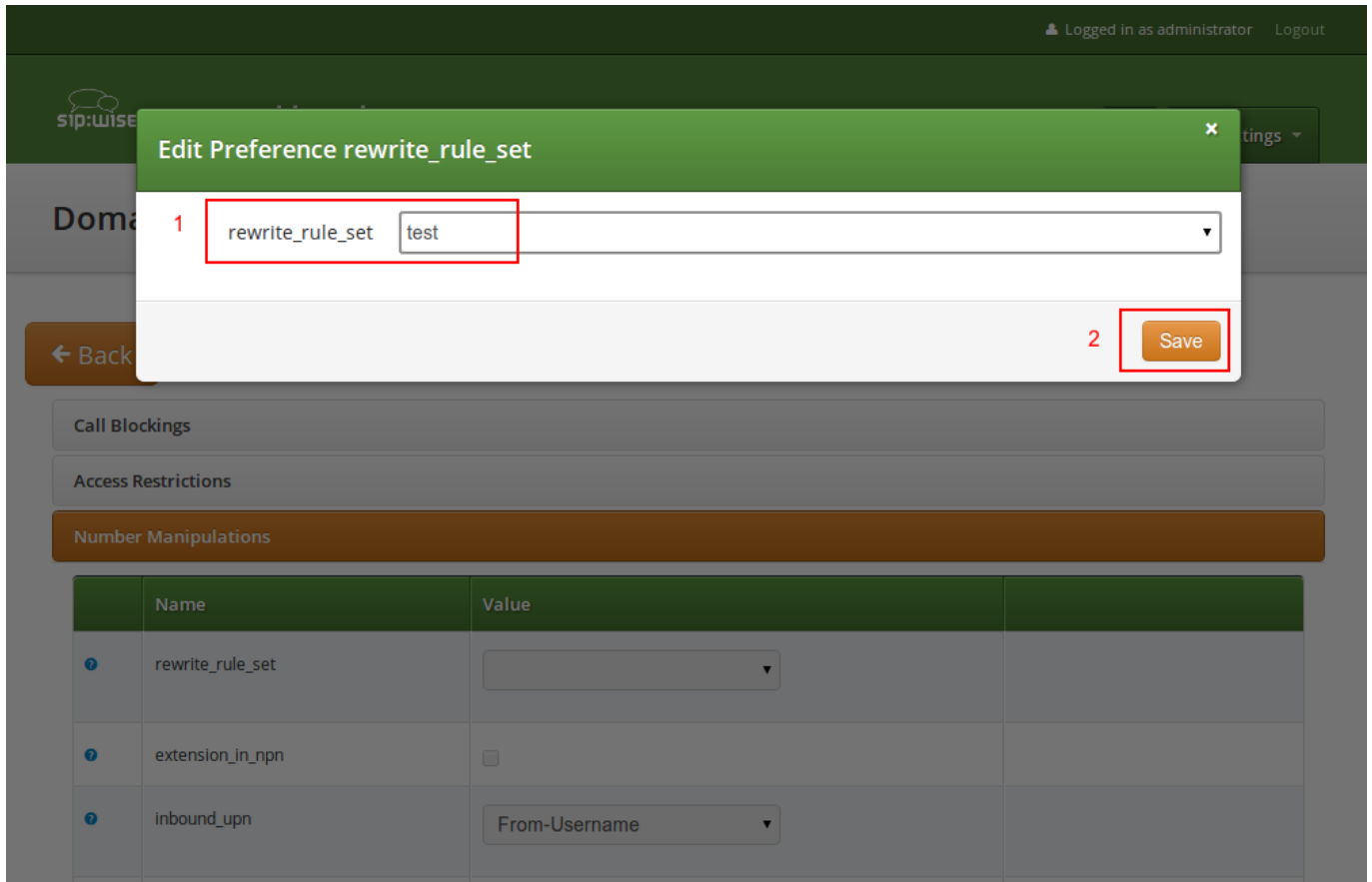

Then, select the field you want the *User Provided Number* to be taken from for inbound INVITE messages. Usually the *From-Username* should be fine, but you can also take it from the *Display-Name* of the From-Header, and other options are available as well.

5.5 Subscriber Preferences

You can override the *Domain Preferences* on a subscriber basis as well. Also, there are *Subscriber Preferences* which don't have a default value in the *Domain Preferences*.

To configure your *Subscriber*, go to *Settings*→*Subscribers* and click *Details* on the row of your subscriber. There, click on the *Preferences* button on top.

You want to look into the *Number Manipulations* and *Access Restrictions* options in particular, which control what is used as user-provided and network-provided calling numbers.

- For outgoing calls, you may define multiple numbers or patterns to control what a subscriber is allowed to send as user-provided calling numbers using the *allowed_clis* preference.
- If *allowed_clis* does not match the number sent by the subscriber, then the number configured in *cli* (the network-provided number) preference will be used as user-provided calling number instead.
- You can override any user-provided number coming from the subscriber using the *user_cli* preference.

Note

Subscribers preference *allowed_clis* will be synchronized with subscribers primary number and aliases if *oss-bss→provisioning→auto_allow_cli* is set to **1** in */etc/ngcp-config/config.yml*.

Note

Subscribers preference *cli* will be synchronized with subscribers primary number if *ossbss→provisioning→auto_sync_cli* is set to **yes** in */etc/ngcp-config/config.yml*.

5.6 Creating Peerings

If you want to terminate calls at or allow calls from 3rd party systems (e.g. PSTN gateways, SIP trunks), you need to create SIP peerings for that. To do so, go to *Settings→Peerings*. There you can add peering groups, and for each peering group add peering servers and rules controlling which calls are routed over these groups. Every peering group needs a peering contract for correct interconnection billing.

5.6.1 Creating Peering Groups

Click on *Create Peering Group* to create a new group.

In order to create a group, you must select a peering contract. You will most likely want to create one contract per peering group.

The screenshot shows the 'Create SIP Peering Groups' modal dialog in the Sipwise web interface. The dialog is titled 'Create SIP Peering Groups' and has a green header. It contains a table for selecting a contract, a search bar, and form fields for Name, Priority, and Description. A 'Create Contract' button is highlighted with a red box.

Contract Search:

#	Status	Billing Profile
No data available in table		

Showing 0 to 0 of 0 entries

Name

Priority

Description

Click on *Create Contract* create a *Contact*, then select a *Billing Profile*.

The screenshot shows the 'Create Contract' modal window. It contains two tables for selection:

Contact Table:

#	Reseller	First Name	Last Name	Email	
1	default	Contact first name	Contact last name	default-customer@default.invalid.contact	1.1 <input checked="" type="checkbox"/>
17	default			myfirstcontact@example.org	<input type="checkbox"/>

Showing 1 to 2 of 2 entries

Billing Profile Table:

#	Reseller	Profile	
1	default	Default Billing Profile	2 <input checked="" type="checkbox"/>

Showing 1 to 1 of 1 entries

Buttons: 'Create Contact' (labeled 'or 1.2'), 'Save' (labeled '3').

Click *Save* on the *Contacts* form, and you will get redirected back to the form for creating the actual *Peering Group*. Put a name, priority and description there, for example:

- **Peering Contract:** select the id of the contract created before
- **Name:** test group
- **Priority:** 1
- **Description:** peering to a test carrier

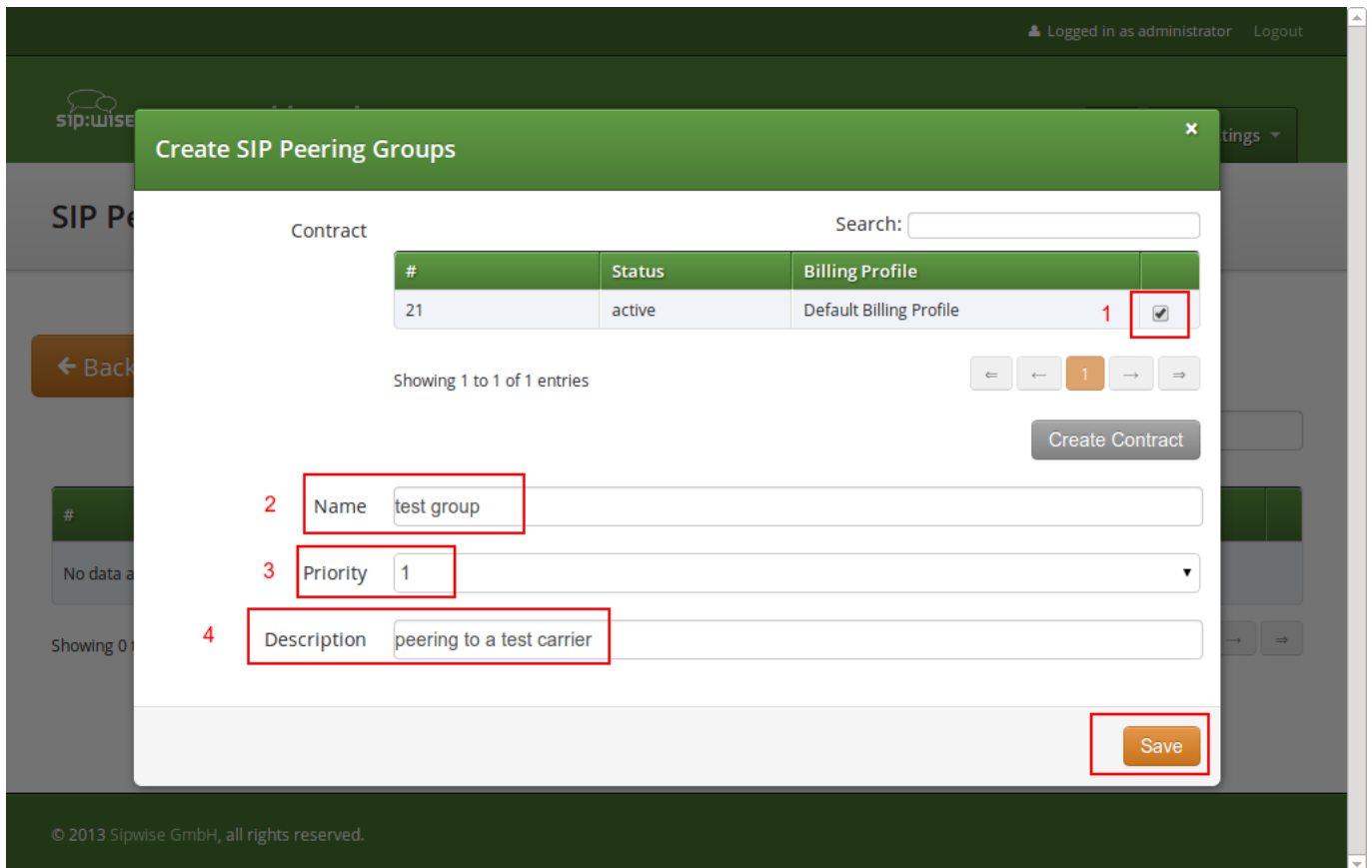

The *Priority* option defines which *Peering Group* to favor (Priority 1 gives the highest precedence) if two peering groups have peering rules matching an outbound call. *Peering Rules* are described below.

Then click *Save* to create the group.

5.6.2 Creating Peering Servers

In the group created before, you need to add peering servers to route calls to and receive calls from. To do so, click on *Details* on the row of your new group in your peering group list.

To add your first *Peering Server*, click on the *Create Peering Server* button.

Peering Servers

← Back
★ Create Peering Server

Show 5 entries Search:

#	Name	IP Address	Hostname	Port	Protocol	Weight	Via Route Set	Enabled
No data available in table								

Showing 0 to 0 of 0 entries ← ← → →

Outbound Peering Rules

ANY of the rules must match to choose the peering group for outbound calls.

★ Create Outbound Peering Rule

Show 5 entries Search:

#	Callee Prefix	Callee Pattern	Caller Pattern	Description	Enabled
No data available in table					

Showing 0 to 0 of 0 entries ← ← → →

Inbound Peering Rules

ALL of the rules must match to choose the peering group for inbound calls.

★ Create Inbound Peering Rule

Show 5 entries Search:

Priority	#	Field	Pattern	Reject Code	Reject Reason	Enabled
No data available in table						

Showing 0 to 0 of 0 entries ← ← → →

Figure 24: Create Peering Server

In this example, we will create a peering server with IP 2.3.4.5 and port 5060:

- **Name:** test-gw-1
- **IP Address:** 2.3.4.5
- **Hostname:** leave empty
- **Port:** 5060
- **Protocol:** UDP
- **Weight:** 1
- **Via Route:** None

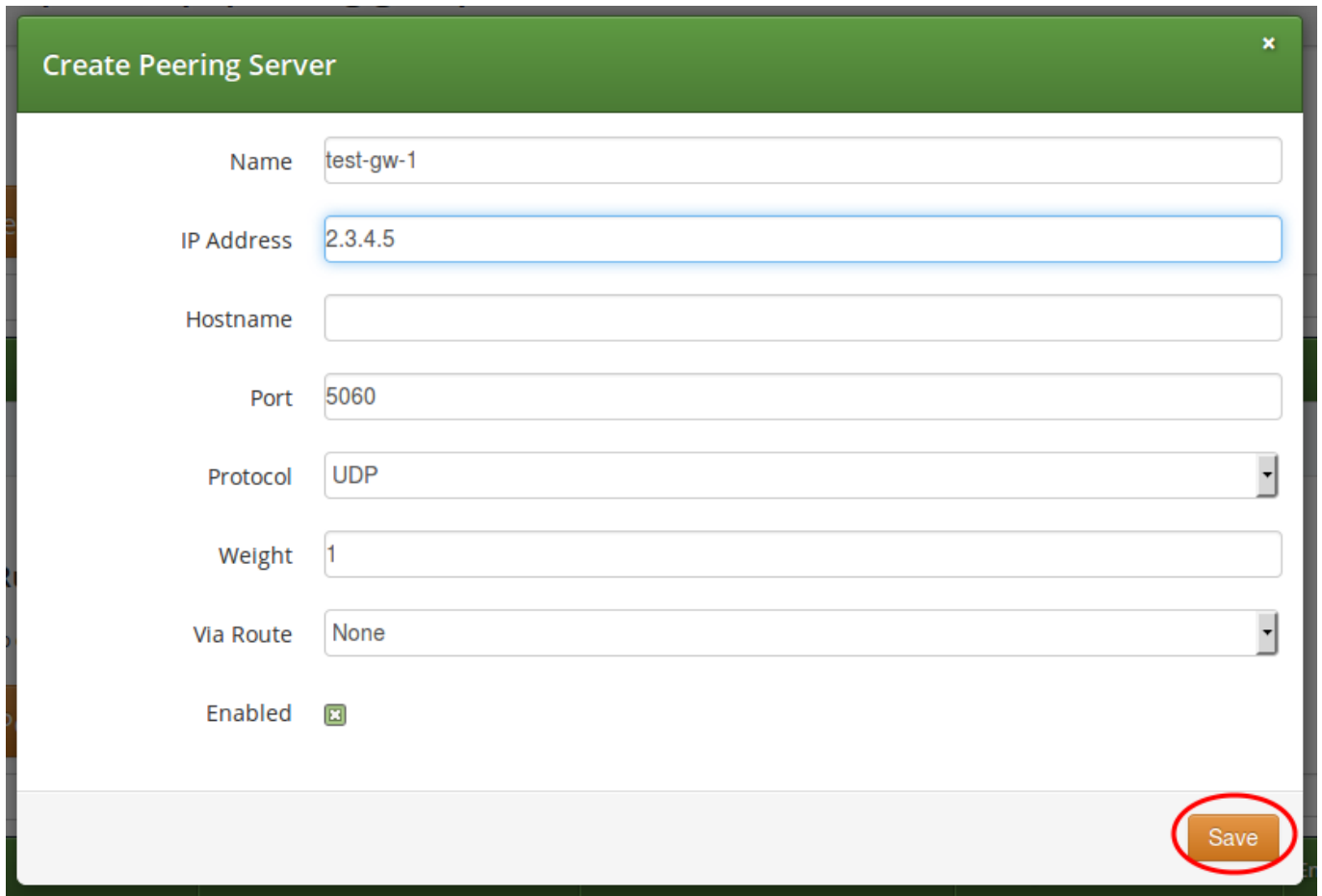

Create Peering Server

Name

IP Address

Hostname

Port

Protocol

Weight

Via Route

Enabled

Save

Figure 25: Peering Server Properties

Click **Save** to create the peering server.

Tip

The *hostname* field for a peering server is optional. Usually, the IP address of the peer is used as the **domain** part of the Request URI. Fill in this field if a peer requires a particular hostname instead of the IP address. The IP address must always be given though as it is used for the selection of the inbound peer. By default outbound requests will always be sent to the specified IP address, no matter what you put into the *hostname* field. If you want to send the request using the DNS resolution of the configured *hostname*, disregarding in that way the IP, you have to enable `outbound_hostname_resolution` option in peer preferences.

Tip

If you want to add a peering server with an IPv6 address, enter the address without surrounding square brackets into the *IP Address* column, e.g. `::1`.

You can force an additional hop (e.g. via an external SBC) towards the peering server by using the *Via Route* option. The available options you can select there are defined in `/etc/ngcp-config/config.yml`, where you can add an array of SIP URIs in

kamailio→lb→external_sbc like this:

```
kamailio:
  lb:
    external_sbc:
      - sip:192.168.0.1:5060
      - sip:192.168.0.2:5060
```

Execute `ngcpcfg apply "added external sbc gateways"`, then edit your peering server and select the hop from the *Via Route* selection.

Once a peering server has been created, this server can already send calls to the system.

5.6.2.1 Outbound Peering Rules



Important

To be able to send outbound calls towards the servers in the *Peering Group*, you also need to define *Outbound Peering Rules*. They specify which source and destination numbers are going to be terminated over this group. To create a rule, click the *Create Outbound Peering Rule* button.

Peering Servers

[← Back](#)
[★ Create Peering Server](#)

Peering server successfully created

Show 5 entries Search:

#	Name	IP Address	Hostname	Port	Protocol	Weight	Via Route Set	Enabled
29	test-gw-1	2.3.4.5		5060	1	1		1

Showing 1 to 1 of 1 entries ◀ ▶ 1 ▶▶

Outbound Peering Rules

ANY of the rules must match to choose the peering group for outbound calls.

[★ Create Outbound Peering Rule](#)

Show 5 entries Search:

#	^	Callee Prefix	Callee Pattern	Caller Pattern	Description	Enabled
No data available in table						

Showing 0 to 0 of 0 entries ◀ ▶ ▶▶

Inbound Peering Rules

ALL of the rules must match to choose the peering group for inbound calls.

[★ Create Inbound Peering Rule](#)

Figure 26: Create Outbound Peering Rule

Since the previously created peering group will be the only one in our example, we have to add a default rule to route *all* calls via this group. To do so, create a new peering rule with the following values:

- **Callee Prefix:** leave empty
- **Callee Pattern:** leave empty
- **Caller Pattern:** leave empty
- **Description:** Default Rule

The screenshot shows a dialog box titled "Create Outbound Peering Rule". It contains the following fields and controls:

- Callee prefix**: An empty text input field.
- Callee pattern**: An empty text input field.
- Caller pattern**: An empty text input field.
- Description**: A text input field containing "Default rule", which is circled in red.
- Enabled**: A checkbox that is checked.
- Save**: A button located at the bottom right, also circled in red.

Figure 27: Outbound Peering Rule Properties

Then click *Save* to add the rule to your group.

Tip

In contrast to the callee/caller pattern, the callee prefix has a regular alphanumeric string and can not contain any regular expression.

Tip

If you set the caller or callee rules to refine what is routed via this peer, enter all phone numbers in full E.164 format, that is `<cc><ac><sn>`.

Tip

The *Caller Pattern* field covers the whole URI including the subscriber domain, so you can only allow certain domains over this peer by putting for example `@example\ .com` into this field.

5.6.2.2 Inbound Peering Rules

Starting from *mr5.0* release, Sipwise C5 supports filtering SIP INVITE requests sent by SIP peers. The system administrator may define one or more matching rules for SIP URIs that are present in the headers of SIP INVITE requests, and select which SIP header (or part of the header) must match the pattern declared in the rule.

If the incoming SIP INVITE message has the proper headers, Sipwise C5 will accept and further process the request. If the message does not match the rule it will be rejected.



Caution

An incoming SIP INVITE message must match **all the inbound peering rules** so that Sipwise C5 does not reject the request.

In order to **create an inbound peering rule** you have to select a peering group, press *Details* and then press *Create Inbound Peering Rule* button.

Peering Servers

← Back ★ Create Peering Server

Show 5 entries Search:

#	Name	IP Address	Hostname	Port	Protocol	Weight	Via Route Set	Enabled
29	test-gw-1	2.3.4.5		5060	1	1		1

Showing 1 to 1 of 1 entries

Outbound Peering Rules

ANY of the rules must match to choose the peering group for outbound calls.

★ Create Outbound Peering Rule

Show 5 entries Search:

#	Callee Prefix	Callee Pattern	Caller Pattern	Description	Enabled
1				Default rule	1

Showing 1 to 1 of 1 entries

Inbound Peering Rules

ALL of the rules must match to choose the peering group for inbound calls.

★ Create Inbound Peering Rule

Show 5 entries Search:

Priority	#	Field	Pattern	Reject Code	Reject Reason	Enabled
No data available in table						

Showing 0 to 0 of 0 entries

Figure 28: Create Inbound Peering Rule

An inbound peering rule has the following **properties**:

Create Inbound Peering Rule

Match Field: To-Domain

Pattern: example\.org

Reject code: 403

Reject reason: Invalid called party domain

Enabled:

Save

Figure 29: Inbound Peering Rule Properties

- `Match Field`: select which header and which part of that header in a SIP INVITE message will be checked for matching the pattern
- `Pattern`: a POSIX regular expression that defines the accepted value of a header; example: `^sip:.*@example\.org$` — this will match a SIP URI that contains "example.org" in the domain part
- `Reject code`: optional; a SIP status code that will be sent as a response to an INVITE request that does not match the pattern; example: 403
- `Reject reason`: optional; an arbitrary text that will be included in the SIP response sent with the *reject code*
- `Enabled`: a flag to enable / disable the particular inbound peering rule

Note

Both of the properties `Reject code` and `Reject reason` must be left empty if a peering server (i.e. a specific IP address) is part of more peering groups. Such a configuration is useful when an incoming SIP INVITE request needs to be treated differently in the affected peering groups, based on its content, and that's why if the INVITE message only partly matches an inbound peering rule it should not simply be rejected.

Tip

Inbound peering rules support POSIX regular expressions, that are different from PCRE regular expressions. So, for instance, an expression like `^3910[0-9]{5}$` can be written as `^3910\d{5}$` in PCRE and `^3910[[:digit:]]{5}$` in POSIX. The kind of regexp used depends on the underlying technology that uses that expression. Since ranges such as [0-9] are always correct, we suggest using that syntax.

When all settings for a peering group are done the details of the group look like:

Peering Servers

← Back
★ Create Peering Server

Show entries Search:

#	Name	IP Address	Hostname	Port	Protocol	Weight	Via Route Set	Enabled
29	test-gw-1	2.3.4.5		5060	1	1		1

Showing 1 to 1 of 1 entries ← ← 1 → →

Outbound Peering Rules

ANY of the rules must match to choose the peering group for outbound calls.

★ Create Outbound Peering Rule

Show entries Search:

#	Callee Prefix	Callee Pattern	Caller Pattern	Description	Enabled
1				Default rule	1

Showing 1 to 1 of 1 entries ← ← 1 → →

Inbound Peering Rules

ALL of the rules must match to choose the peering group for inbound calls.

★ Create Inbound Peering Rule

Show entries Search:

Priority	#	Field	Pattern	Reject Code	Reject Reason	Enabled
50	1	to_domain	example\org	403	Invalid called party domain	1

Showing 1 to 1 of 1 entries ← ← 1 → →

Figure 30: Peering Servers Overview

5.6.2.3 Routing Order Selection

The selection of peering groups and peering servers for outgoing calls is done in the following way:

- All peering groups that meet the following criteria configured in the outbound peering rule are added to the list of routes for a particular call:
 - Callee's username matches *callee prefix*
 - Callee's URI matches *callee pattern*
 - Caller's URI matches *caller pattern*
- When all matching peering groups are selected, they are ordered by *callee prefix* according to the **longest match basis** (sometimes referred to as the **longest pattern match** or **maximum pattern length match**). One or more peering group with longest *callee prefix* match will be given first positions on the list of routes.

3. Peering groups with the same *callee prefix* length are further ordered by **Priority**. Peering group(s) with the higher priorities will occupy higher positions.



Important

Priority **1** gives the *highest* precedence to the corresponding peering group. Hence, a lower priority value will put the peering group higher in the list of routes (compared to other peering groups with the same *callee prefix* length).

Priority can be selected from **1** (highest) to **9** (lowest).

4. All peering servers in the peering group with the highest priority (e.g. priority **1**) are tried one-by-one starting from the highest server weight. Peering groups with lower priorities or with shorter *callee prefix* will be used only for fail-over.

The **weight** of the peering servers in the selected peering group will influence the order in which the servers within the group will be tried for routing the outbound call. The weight of a server can be set in the range from **1** to **127**.



Important

Opposite to the peering group priority, a peering server with a higher weight value has a *higher* precedence, but the server weight rather sets a probability than a strict order. E.g. although a peering server with weight **127** has the highest chance to be the first in the list of routes, another server with a lower weight (e.g. **100**) sometimes will be selected first.

In order to find out this probability knowing the weights of peering servers, use the following script:

```
#!/usr/bin/perl

#This script can be used to find out actual probabilities
#that correspond to a list of peering weights.

$num_args = $#ARGV + 1;
if ($num_args < 1) {
    print "Usage: lcr_weight_test.pl <list of weights (integers 1-254)>\n";
    exit 0;
}

my $iters = 10000;
my @rands;

for (my $i=1; $i <= $iters; $i++) {
    my %elem;
    for (my $j=0; $j < $num_args; $j++) {
        my $random = int(rand(2000000000));
        $elem{"$j"} = $ARGV[$j] * $random;
    }
    push(@rands, \%elem);
}
```

```

}

my @counts;
for (my $j=0; $j < $num_args; $j++) {
    $counts["$j"] = 0;
}

foreach my $rand (@rands) {
    my $higher = 0;
    my $higher_key = 0;
    foreach $key (keys %{$rand}) {
        if ($rand->{$key} > $higher) {
            $higher = $rand->{$key};
            $higher_key = $key;
        }
    }
    $counts[$higher_key]++;
}

for (my $j=0; $j < $num_args; $j++) {
    my $prob = $counts[$j]/$iters;
    print "Peer with weight $ARGV[$j] has probability $prob \n";
}

```

Let us say you have 2 peering servers, one with weight 1 and another with weight 2. At the end—running the script as below—you will have the following traffic distribution:

```

# lcr_weight_test.pl 1 2

Peer with weight 1 has probability 0.2522
Peer with weight 2 has probability 0.7478

```

If a peering server replies with SIP codes 408, 500 or 503, or if a peering server doesn't respond at all, the next peering server in the current peering group is tried as a fallback. All the servers within the group are tried one after another until the call succeeds. If no more servers are left in the current peering group, the next group which matches the outbound peering rules is used.

Note

The Sipwise C5 may use a slightly different approach in selecting the appropriate peering server if the *peer probing* feature is enabled. See the details in Section 6.12 of the handbook.

5.6.2.4 Least Cost Routing (LCR) Configuration

The default call routing uses statically configured peering group priorities to decide where to send the calls. This solution is useful when you have an external SBC that makes all the routing decisions and is described in the [Routing Order Selection](#) section.

Sipwise C5 also allows you routing calls to the cheapest SIP peers saving your termination cost.

To enable LCR routing, do the following:

- Upload the billing fees provided by your peers to the corresponding peering billing profiles
- Enable the LCR module in config.yml (kamailio.proxy.perform_peer_lcr: yes)

When the LCR routing is enabled, the selection of peering groups would be the following:

1. All peering groups that meet the following criteria configured in the outbound peering rule are added to the list of routes for a particular call (for pure LCR you might want to omit these filters leaving them blank):
 - Callee's username matches *callee prefix*
 - Callee's URI matches *callee pattern*
 - Caller's URI matches *caller pattern*
2. When all matching peering groups are selected, the longest matching *callee prefix* is selected from each of them. And the peering groups are *temporary* ordered according to the longest matching prefix and priority.
3. Then, the LCR module re-orders the peering groups starting from the lowest termination cost to the highest (ignoring the prefix length and peering group priorities).
4. The platform will first route the call to the servers of the first peering group in this list. If no peering server can terminate the call, the call would fail-over to the second peering group from the list and so on.

Note

The peering servers in every peering group are sorted and tried according to their weight as described in the previous section.

Let us consider a short example. There are two peering groups (PG1 and PG2) that can deliver calls to New York (e.g. 12121234567) and they have the following rates:

Peering Group	Prefix	Cost	Description
PG1	1	0.02	USA & Canada
PG2	1	0.05	USA & Canada
	1212	0.03	New York, USA

PG1 has only one rate that matches the dialed number, so that it will be taken into account, PG2 has two rates and the longest will be selected. The call will be routed to PG1 servers first as it has a cheaper price and can fail-over to PG2 servers.

The Sipwise C5 LCR feature together with the codec filtering, media transcoding, header manipulations, SIP, and RTP encryption and other SBC features make an external SBC unnecessary. This simplifies your VoIP network and cuts deployment and operation costs.

5.6.3 Authenticating and Registering against Peering Servers

5.6.3.1 Proxy-Authentication for outbound calls

If a peering server requires Sipwise C5 to authenticate for outbound calls (by sending a 407 as response to an INVITE), then you have to configure the authentication details in the *Preferences* view of your peer host.

Peering Servers

← Back ★ Create Peering Server

Show 5 entries Search:

#	Name	IP Address	Hostname	Port	Protocol	Weight	Via Route Set	Enabled	
29	test-gw-1	2.3.4.5		5060	1	1		1	Edit Delete Preferences

Showing 1 to 1 of 1 entries

Outbound Peering Rules

ANY of the rules must match to choose the peering group for outbound calls.

★ Create Outbound Peering Rule

Show 5 entries Search:

#	Callee Prefix	Callee Pattern	Caller Pattern	Description	Enabled	
1				Default rule	1	

Showing 1 to 1 of 1 entries

Inbound Peering Rules

ALL of the rules must match to choose the peering group for inbound calls.

★ Create Inbound Peering Rule

Figure 31: Select Peering Server Preferences

To configure this setting, open the *Remote Authentication* tab and edit the following three preferences:

- **peer_auth_user:** <username for peer auth>
- **peer_auth_pass:** <password for peer auth>
- **peer_auth_realm:** <domain for peer auth>

← Back

Preference peer_auth_realm successfully updated.

Access Restrictions

Number Manipulations

NAT and Media Flow Control

Remote Authentication

	Name	Value	
	peer_auth_user 1	peeruser1	
	peer_auth_pass 2	peerpass1	
	peer_auth_realm 3	testpeering.com	
	peer_auth_register	<input type="checkbox"/>	
	find_subscriber_by_uuid	<input type="checkbox"/>	

Session Timers

Important



If you do NOT authenticate against a peer host, then the caller CLI is put into the From and P-Asserted-Identity headers, e.g. "+4312345" <sip:+4312345@your-domain.com>. If you DO authenticate, then the From header is "+4312345" <sip:your_peer_auth_user@your_peer_auth_realm> (the CLI is in the Display field, the peer_auth_user in the From username and the peer_auth_realm in the From domain), and the P-Asserted-Identity header is as usual like <sip:+4312345@your-domain.com>. So for presenting the correct CLI in *CLIP no screening* scenarios, your peering provider needs to extract the correct user either from the From Display-Name or from the P-Asserted-Identity URI-User.

Tip

If **peer_auth_realm** is set, the system may overwrite the Request-URI with the peer_auth_realm value of the peer when sending the call to that peer or peer_auth_realm value of the subscriber when sending a call to the subscriber. Since this is rarely a desired behavior, it is disabled by default starting with Sipwise C5 release 3.2. If you need the replacement, you should set `set_ruri_to_peer_auth_realm: 'yes'` in `/etc/ngcp-config/config.yml`.

5.6.3.2 Registering at a Peering Server

Unfortunately, the credentials configured above are not yet automatically used to register Sipwise C5 at your peer hosts. There is however an easy manual way to do so, until this is addressed.

Configure your peering servers with the corresponding credentials in `/etc/ngcp-config/templates/etc/ngcp-sems/etc/reg_agent.conf.tt2`, then execute `ngcpcfg apply "added upstream credentials"`.



Important

Be aware that this will force SEMS to restart, which will drop running conference calls.

5.7 Configuring Rewrite Rule Sets

On the NGCP, every phone number is treated in E.164 format `<country code><area code><subscriber number>`. Rewrite Rule Sets is a flexible tool to translate the caller and callee numbers to the proper format before the routing lookup and after the routing lookup separately. The created Rewrite Rule Sets can be assigned to the domains, subscribers and peers as a preference. Here below you can see how the Rewrite Rules are used by the system:

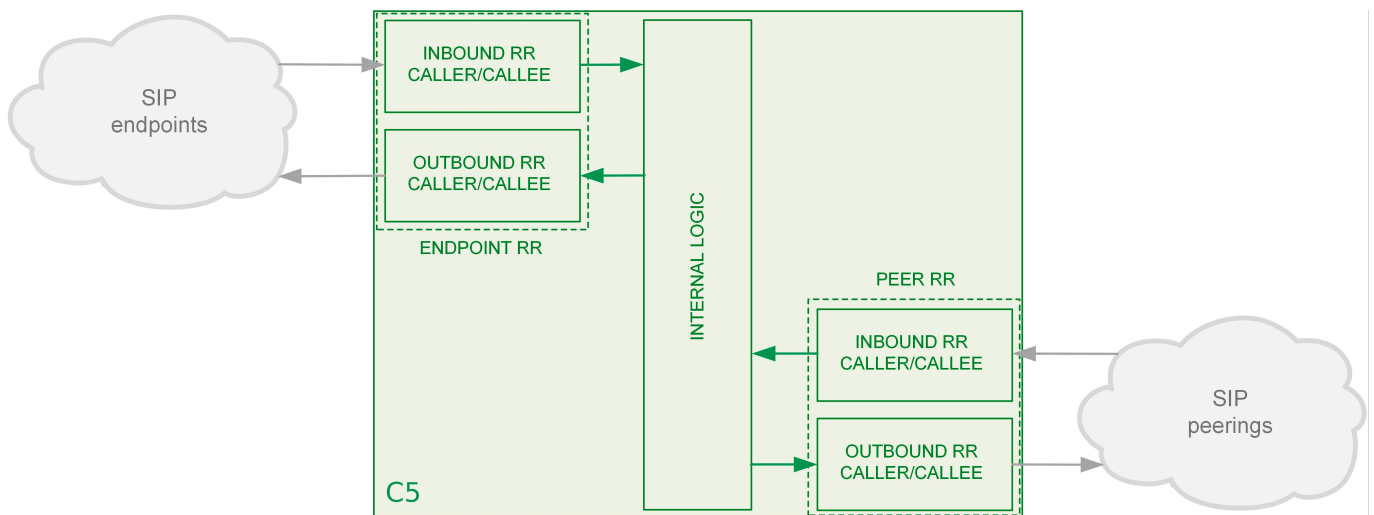

As from the image above, following the arrows, you will have an idea about which type of Rewrite Rules are applied during a call. In general:

- Call from local subscriber A to local subscriber B: Inbound RR from local Domain/Subscriber A and Outbound Rewrite Rules from local Domain/Subscriber B.
- Call from local subscriber A to the peer: Inbound RR from local Domain/Subscriber A and Outbound Rewrite Rules from the peer.
- Call from peer to local subscriber B: Inbound RR from the Peer and Outbound Rewrite Rules from local Domain/Subscriber B.

You would normally begin with creating a Rewrite Rule Set for your SIP domains. This is used to control what an end user can dial for outbound calls, and what is displayed as the calling party on inbound calls. The subscribers within a domain inherit Rewrite Rule Sets of that domain, unless this is overridden by a subscriber Rewrite Rule Set preference.

You can use several special variables in the Rewrite Rules, below you can find a list of them. Some examples of how to use them are also provided in the following sections:

- `${caller_cc}` : This is the value taken from the subscriber's preference CC value under Number Manipulation
- `${caller_ac}` : This is the value taken from the subscriber's preference AC value under Number Manipulation
- `${caller_emergency_cli}` : This is the value taken from the subscriber's preference emergency_cli value under Number Manipulation
- `${caller_emergency_prefix}` : This is the value taken from the subscriber's preference emergency_prefix value under Number Manipulation
- `${caller_emergency_suffix}` : This is the value taken from the subscriber's preference emergency_suffix value under Number Manipulation
- `${caller_cloud_pbx_base_cli}` : This is the value taken from the *Primary Number* field from section *Details* → *Master Data* of the *Pilot Subscriber* for a particular PBX customer.

To create a new Rewrite Rule Set, go to *Settings*→*Rewrite Rule Sets*. There you can create a Set identified by a name. This name is later shown in your peer-, domain- and user-preferences where you can select the rule set you want to use.

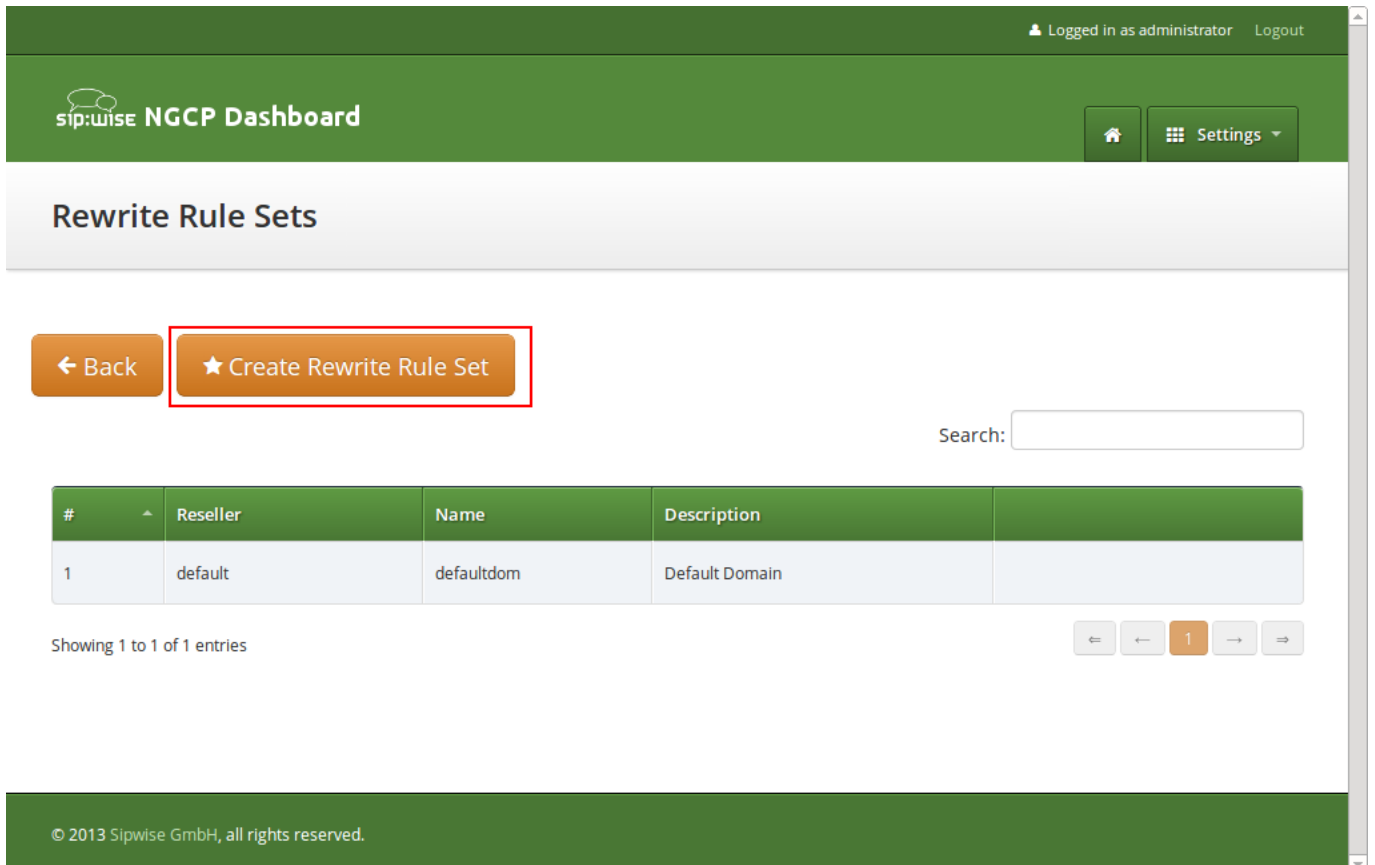

The screenshot shows the Sipwise NGCP Dashboard interface. At the top, it indicates the user is logged in as an administrator. The main header is green with the Sipwise logo and 'NGCP Dashboard'. Below the header, there's a navigation bar with a home icon and a 'Settings' dropdown menu. The main content area is titled 'Rewrite Rule Sets'. There are two buttons: 'Back' and 'Create Rewrite Rule Set', with the latter being highlighted by a red box. A search input field is present to the right. Below the buttons is a table with columns for '#', 'Reseller', 'Name', and 'Description'. The table contains one entry with the following data:

#	Reseller	Name	Description
1	default	defaultdom	Default Domain

Below the table, it says 'Showing 1 to 1 of 1 entries' and there are pagination controls showing '1'.

© 2013 Sipwise GmbH, all rights reserved.

Click *Create Rewrite Rule Set* and fill in the form accordingly.

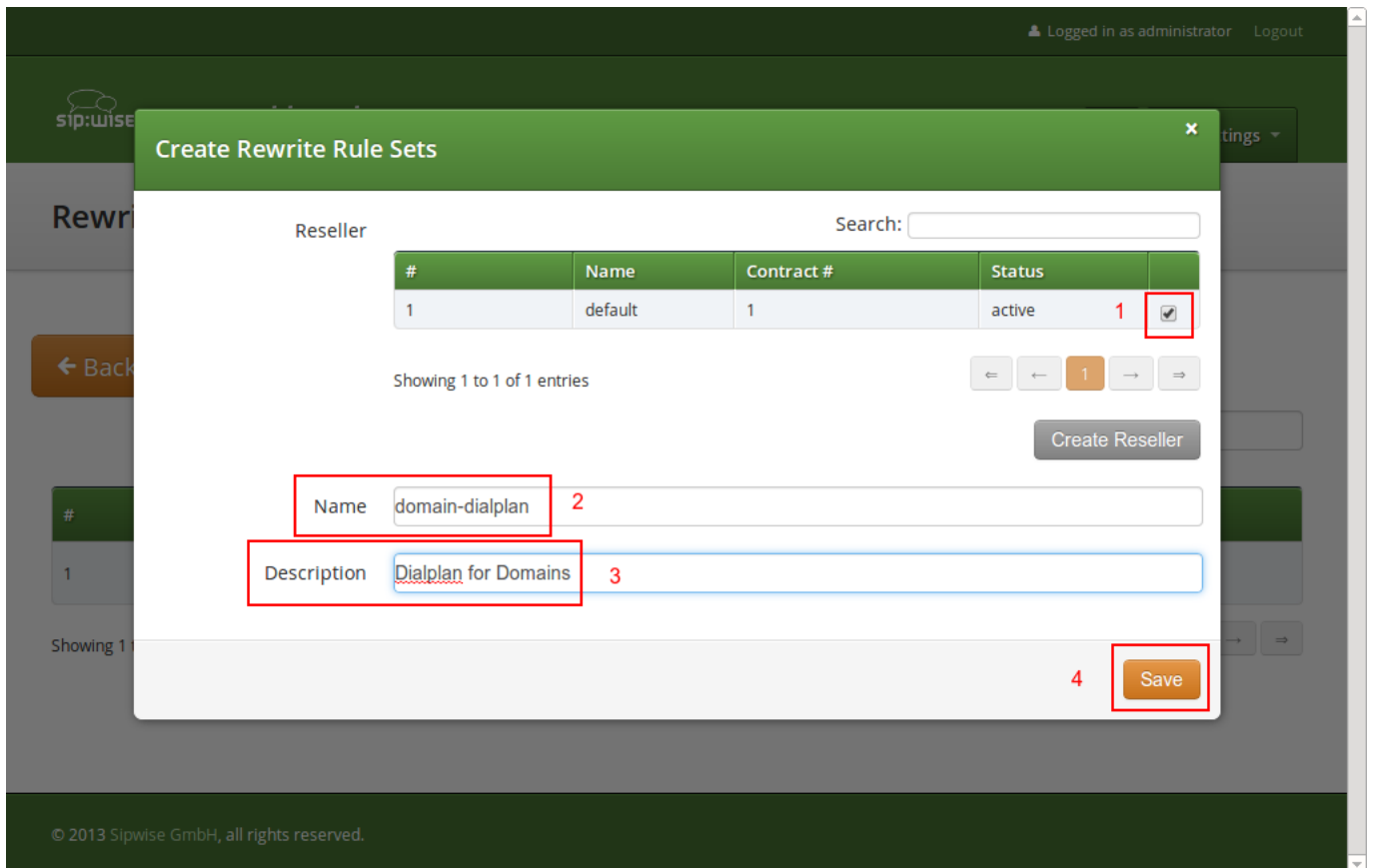

Press the *Save* button to create the set.

To view the *Rewrite Rules* within a set, hover over the row and click the *Rules* button.

Logged in as administrator Logout

sip:wise NGCP Dashboard

Home Settings

Rewrite Rule Sets

Back Create Rewrite Rule Set

Rewrite rule set successfully created

Search:

#	Reseller	Name	Description	
1	default	defaultdom	Default Domain	
2	default	domain-dialplan	Dialplan for Domains	Edit Delete Rules

Showing 1 to 2 of 2 entries

← 1 →

The rules are ordered by *Caller* and *Callee* as well as direction *Inbound* and *Outbound*.

Tip

In Europe, the following formats are widely accepted: `+<cc><ac><sn>`, `00<cc><ac><sn>` and `0<ac><sn>`. Also, some countries allow the areacode-internal calls where only subscriber number is dialed to reach another number in the same area. Within this section, we will use these formats to show how to use rewrite rules to normalize and denormalize number formats.

5.7.1 Inbound Rewrite Rules for Caller

These rules are used to normalize user-provided numbers (e.g. passed in *From Display Name* or *P-Preferred-Identity* headers) into E.164 format. In our example, we'll normalize the three different formats mentioned above into E.164 format.

To create the following rules, click on the *Create Rewrite Rule* for each of them and fill them with the values provided below.

STRIP LEADING 00 OR +

- Match Pattern: `^(00|\+)([1-9][0-9]+)$`
- Replacement Pattern: `\2`
- Description: International to E.164
- Direction: Inbound

- Field: Caller

REPLACE 0 BY CALLER'S COUNTRY CODE:

- Match Pattern: `^0([1-9][0-9]+)$`
- Replacement Pattern: `${caller_cc}\1`
- Description: National to E.164
- Direction: Inbound
- Field: Caller

NORMALIZE LOCAL CALLS:

- Match Pattern: `^([1-9][0-9]+)$`
- Replacement Pattern: `${caller_cc}${caller_ac}\1`
- Description: Local to E.164
- Direction: Inbound
- Field: Caller

The screenshot shows the 'Create Rule' dialog box in the Sipwise interface. The dialog is a white box with a green header and a close button. It contains several fields: 'Match pattern' with the value '^([00|+)([1-9][0-9]+)\$' and a red box around it labeled '1'; 'Replacement Pattern' with the value '\2' and a red box around it labeled '2'; 'Description' with the value 'International to E.164' and a red box around it labeled '3'; 'Direction' with the value 'Inbound' and a red box around it labeled '4'; 'Field' with the value 'Caller' and a red box around it labeled '5'; and a 'Save' button at the bottom right with a red box around it labeled '6'. The background shows a blurred interface with a 'Logged in as administrator' status and a 'Logout' link.

Normalization for national and local calls is possible with special variables `${caller_cc}` and `${caller_ac}` that can be used in Replacement Pattern and are substituted by the country and area code accordingly during the call routing.



Important

These variables are only being filled in when a call originates from a subscriber (because only then the cc/ac information is known by the system), so you can not use them when a calls comes from a SIP peer (the variables will be just empty in this case).

Tip

When routing a call, the rewrite processing is stopped after the first match of a rule, starting from top to bottom. If you have two rules (e.g. a generic one and a more specific one), where both of them would match some numbers, reorder them with the up/down arrows into the appropriate position.

Rewrite Rules for domain-dialplan

← Back

★ Create Rewrite Rule

Rewrite rule successfully created

Inbound Rewrite Rules for Caller

	Match Pattern	Replacement Pattern	Description
1	↑ ↓ <input type="checkbox"/> <input type="checkbox"/>	^(00 \+)([1-9][0-9]+)\$	\2 International to E.164
	↑ ↓ <input type="checkbox"/> <input type="checkbox"/> 2	^0([1-9][0-9]+)\$	\$(caller_cc)\1 National to E.164
	↑ ↓ <input type="checkbox"/> <input type="checkbox"/>	^([1-9][0-9]+)\$	\$(caller_cc)\$(caller_ac)\1 Local to E.164

Inbound Rewrite Rules for Callee

Outbound Rewrite Rules for Caller

Outbound Rewrite Rules for Callee

5.7.2 Inbound Rewrite Rules for Callee

These rules are used to rewrite the number the end user dials to place a call to a standard format for routing lookup. In our example, we again allow the three different formats mentioned above and again normalize them to E.164, so we put in the same rules as for the caller.

STRIP LEADING 00 OR +

- Match Pattern: `^(00|\+)([1-9][0-9]+)$`
- Replacement Pattern: `\2`

- **Description:** International to E.164
- **Direction:** Inbound
- **Field:** Callee

REPLACE 0 BY CALLER'S COUNTRY CODE:

- **Match Pattern:** `^0([1-9][0-9]+)$`
- **Replacement Pattern:** `${caller_cc}\1`
- **Description:** National to E.164
- **Direction:** Inbound
- **Field:** Callee

NORMALIZE AREACODE-INTERNAL CALLS:

- **Match Pattern:** `^([1-9][0-9]+)$`
- **Replacement Pattern:** `${caller_cc}${caller_ac}\1`
- **Description:** Local to E.164
- **Direction:** Inbound
- **Field:** Callee

Tip

Our provided rules will only match if the caller dials a numeric number. If he dials an alphanumeric SIP URI, none of our rules will match and no rewriting will be done. You can however define rules for that as well. For example, you could allow your end users to dial `support` and rewrite that to your support hotline using the match pattern `^support$` and the replace pattern `43800999000` or whatever your support hotline number is.

5.7.3 Outbound Rewrite Rules for Caller

These rules are used to rewrite the calling party number for a call to an end user. For example, if you want the device of your end user to show `0<ac><sn>` if a national number calls this user, and `00<cc><ac><sn>` if an international number calls, put the following rules there.

REPLACE AUSTRIAN COUNTRY CODE 43 BY 0

- **Match Pattern:** `^43([1-9][0-9]+)$`
- **Replacement Pattern:** `0\1`
- **Description:** E.164 to Austria National

- **Direction:** Outbound
- **Field:** Caller

PREFIX 00 FOR INTERNATIONAL CALLER

- **Match Pattern:** `^ ([1-9] [0-9]+) $`
- **Replacement Pattern:** `00\1`
- **Description:** E.164 to International
- **Direction:** Outbound
- **Field:** Caller

Tip

Note that both of the rules would match a number starting with 43, so reorder the national rule to be above the international one (if it's not already the case).

5.7.4 Outbound Rewrite Rules for Callee

These rules are used to rewrite the called party number immediately before sending out the call on the network. This gives you an extra flexibility by controlling the way request appears on a wire, when your SBC or other device expects the called party number to have a particular tech-prefix. It can be used on calls to end users too if you want to do some processing in intermediate SIP device, e.g. apply legal intercept selectively to some subscribers.

PREFIX SIPSP# FOR ALL CALLS

- **Match Pattern:** `^ ([0-9]+) $`
- **Replacement Pattern:** `sipsp#\1`
- **Description:** Intercept this call
- **Direction:** Outbound
- **Field:** Callee

5.7.5 Emergency Number Handling

There are 2 ways to handle calls from local subscribers to emergency numbers in NGCP:

- *Simple* emergency number handling: inbound rewrite rules append an emergency tag to the called number, this will be recognised by NGCP's call routing logic and the call is routed directly to a peer. Please read the next section for details of simple emergency number handling.
- An emergency *number mapping* is applied: a dedicated emergency number mapping database is consulted in order to obtain the most appropriate routing number of emergency services. This logic ensures that the caller will contact the geographically closest emergency service. Please visit the [Emergency Mapping](#) section of the handbook for more details.

5.7.5.1 Simple Emergency Number Handling Overview

The overview of emergency call processing is as follows:

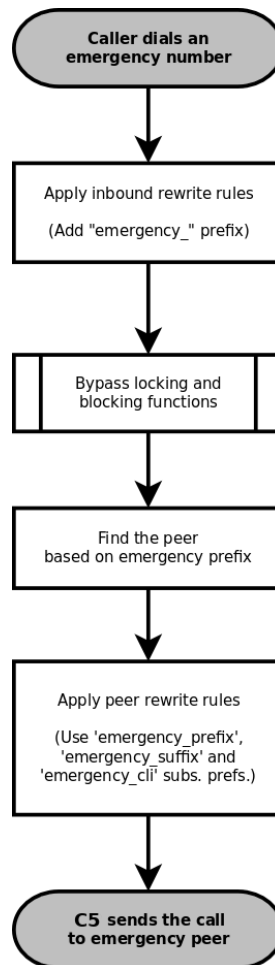

Figure 32: Simple Emergency Call Handling

Configuring Emergency Numbers is also done via Rewrite Rules.

5.7.5.2 Tagging Inbound Emergency Calls

For Emergency Calls from a subscriber to the platform, you need to define an *Inbound Rewrite Rule For Callee*, which adds a prefix `emergency_` to the number (and can rewrite the number completely as well at the same time). If the proxy detects a call to a SIP URI starting with `emergency_`, it will enter a special routing logic bypassing various checks which might make a normal call fail (e.g. due to locked or blocked numbers, insufficient credits or exceeding the max. amount of parallel calls).

TAG AN EMERGENCY CALL

- Match Pattern: `^(911|112)$`
- Replacement Pattern: `emergency_\1`

- **Description:** Tag Emergency Numbers
- **Direction:** Inbound
- **Field:** Callee

To route an Emergency Call to a Peer, you can select a specific peering group by adding a peering rule with a *callee prefix* set to *emergency_* to a peering group.

5.7.5.3 Normalize Emergency Calls for Peers

In order to normalize the emergency number to a valid format accepted by the peer, you need to assign an *Outbound Rewrite Rule For Callee*, which strips off the *emergency_* prefix. You can also use the variables `${caller_emergency_cli}`, `${caller_emergency_prefix}` and `${caller_emergency_suffix}` as well as `${caller_ac}` and `${caller_cc}`, which are all configurable per subscriber to rewrite the number into a valid format.

NORMALIZE EMERGENCY CALL FOR PEER

- **Match Pattern:** `^emergency_(.+)$`
- **Replacement Pattern:** `${caller_emergency_prefix}${caller_ac}\1`
- **Description:** Normalize Emergency Numbers
- **Direction:** Outbound
- **Field:** Callee

5.7.6 Assigning Rewrite Rule Sets to Domains and Subscribers

Once you have finished to define your Rewrite Rule Sets, you need to assign them. For sets to be used for subscribers, you can assign them to their corresponding domain, which then acts as default set for all subscribers. To do so, go to *Settings*→*Domains* and click *Preferences* on the domain you want the set to assign to. Click on *Edit* and select the Rewrite Rule Set created before.

The screenshot shows the 'Number Manipulations' section of the Sipwise NGCP Dashboard. The dashboard header is green with the 'sip:wise NGCP Dashboard' logo and a 'Settings' menu. Below the header is a white bar with the domain name 'Domain "demo.sipwise.com" - Preferences'. A navigation bar contains three items: 'Call Blockings', 'Access Restrictions 1', and 'Number Manipulations' (highlighted in orange). Below the navigation bar is a table with four rows. The first row is highlighted in light blue and has an 'Edit' button. The table columns are 'Name', 'Value', and an action column. The 'rewrite_rule_set' row has a value of 'defaultdom' and an 'Edit' button. The other rows are 'extension_in_npn' (checkbox), 'inbound_upn' (From-Username), and 'outbound_from_user' (User-Provided-Number).

Name	Value	
rewrite_rule_set	defaultdom	Edit
extension_in_npn	<input type="checkbox"/>	
inbound_upn	From-Username	
outbound_from_user	User-Provided-Number	

You can do the same in the *Preferences* of your subscribers to override the rule on a subscriber basis. That way, you can finely control down to an individual user the dial-plan to be used. Go to *Settings*→*Subscribers*, click the *Details* button on the subscriber you want to edit, then click the *Preferences* button.

5.7.7 Creating Dialplans for Peering Servers

For each peering server, you can use one of the Rewrite Rule Sets that was created previously as explained in Section 5.7 (keep in mind that special variables `${caller_ac}` and `${caller_cc}` can not be used when the call comes from a peer). To do so, click on the name of the peering server, look for the preference called *Rewrite Rule Sets*.

If your peering servers don't send numbers in E.164 format `<cc><ac><sn>`, you need to create *Inbound Rewrite Rules* for each peering server to normalize the numbers for caller and callee to this format, e.g. by stripping leading + or put them from national into E.164 format.

Likewise, if your peering servers don't accept this format, you need to create *Outbound Rewrite Rules* for each of them, for example to append a + to the numbers.

5.7.8 Call Routing Verification

The Sipwise C5 provides a utility that helps with the verification of call routing among local subscribers and peers. It is called *Call Routing Verification* and employs rewrite rules and peer selection rules, in order to process calling and called numbers or SIP users and find the appropriate peer for the destination.

The *Call Routing Verification* utility performs only basic number processing and does not invoke the full number manipulation logic applied on real calls. The goal is to enable testing of rewrite rules, rather than validate the complete number processing.

- What is considered during the test:
 - subscriber preferences: `cli` and `allowed_clis`
 - domain / subscriber / peer rewrite rules
- What is not taken into account during the test:
 - other subscriber or peer preferences
 - LNP (Local Number Portability) lookup on called numbers; LNP rewrite rules

You can access the utility following the path on Admin web interface: *Tools* → *Call Routing Verification*.

Expected input data

- `Caller number/uri`: 2 formats are accepted in this field:
 - A simple **phone number** in international (00431 . . , +431 . .) or E.164 (431 . .) format.
 - A SIP **URI** in `username@domain` format (without adding "sip:" at the beginning).
- `Callee number/uri`: The same applies as for `Caller number/uri`.
- `Caller Type`: Select `Subscriber` or `Peer`, depending on the source of the call.
- `Caller Subscriber` or `Caller Peer`: Optionally, you can select the subscriber or peer explicitly. Without the explicit selection, however, the *Call Routing Verification* tool is able to find the caller in the database, based on the provided number / URI.
- `Caller RWR Override`, `Callee RWR Override`, `Callee Peer Override`: The caller / callee rewrite rules and peer selection rules defined in domain, subscriber and peer preferences are used for call processing by default. But you can also override them by explicitly selecting another rewrite or peer selection rule.

Examples

1. Using only phone numbers and explicit subscriber selection

- Input Data:

Call Routing Verification

[← Back](#) [Expand Groups](#)

Caller number/url:

Callee number/url:

Caller Type: Subscriber Peer

Caller Subscriber Search:

#	Username	Domain	UUID	Number	
295	43993002	10.15.18.227	51e32173-c8a9-44f1-af30-a1ed431eb2bf		<input checked="" type="checkbox"/>
297	43993003	10.15.18.227	6feb9ea-21c0-4f55-8828-80d546b8998f		<input type="checkbox"/>
299	43993004	10.15.18.227	3543a26e-861b-459f-a348-a8ef3e1e9eab		<input type="checkbox"/>
301	43993005	10.15.18.227	355773d2-1c08-475c-8858-eaf75bb58c73		<input type="checkbox"/>

Showing 1 to 4 of 8 entries (filtered from 56 total entries) ← 1 2 →

Caller Rewrite Rules Override

Callee Rewrite Rules Override

Callee Peer Override

[Verify](#)

Figure 33: Call Routing Verif. - Only Numbers - Input

- Result:

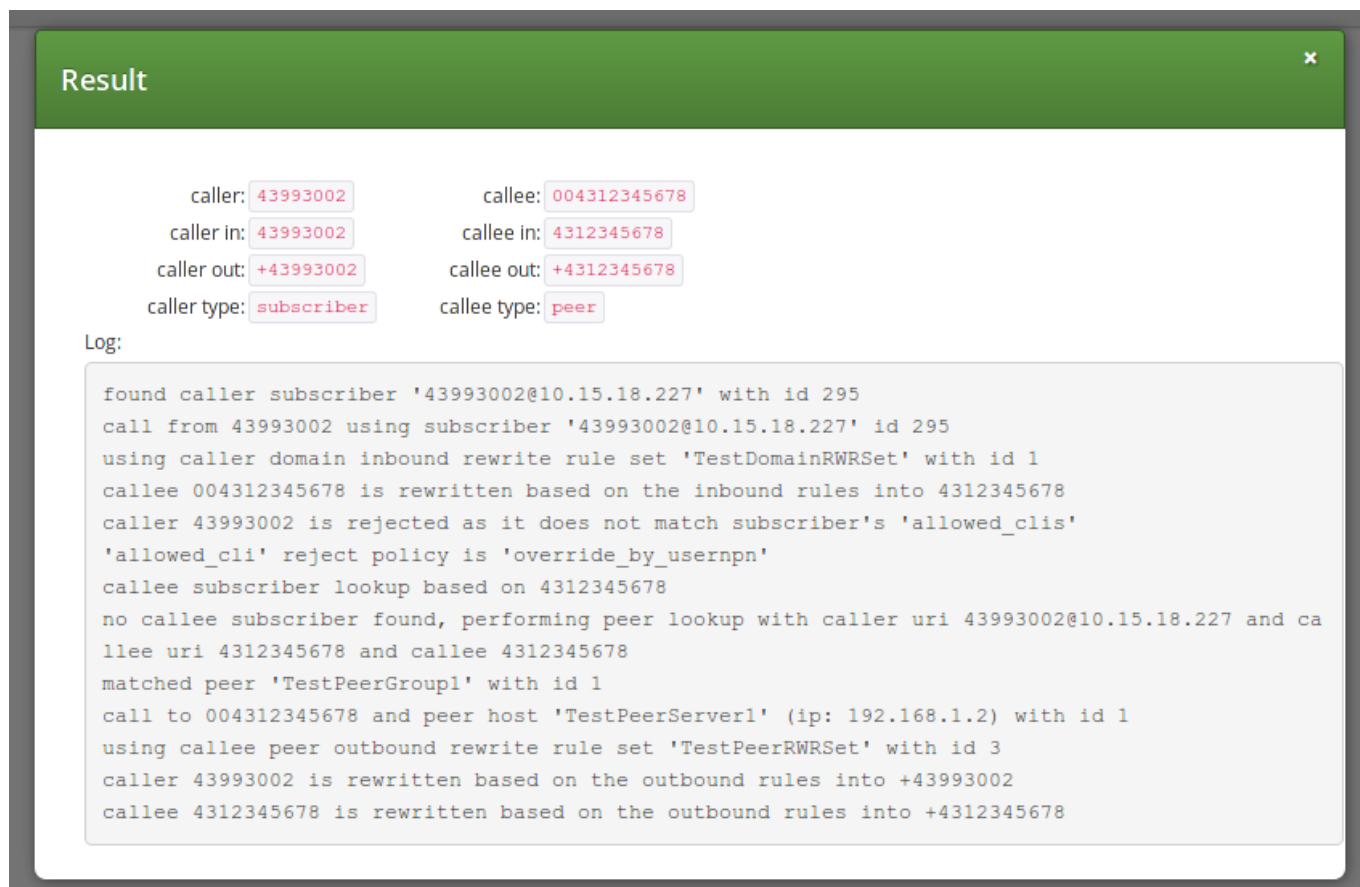

The screenshot shows a 'Result' window with a green header and a close button. It displays call routing information for a call from 43993002 to 004312345678. The caller is identified as a 'subscriber' and the callee as a 'peer'. A log section provides a detailed step-by-step account of the routing process, including domain rewrite rules, subscriber lookups, and peer group matching.

caller: 43993002 callee: 004312345678
caller in: 43993002 callee in: 4312345678
caller out: +43993002 callee out: +4312345678
caller type: subscriber callee type: peer

Log:

```
found caller subscriber '43993002@10.15.18.227' with id 295
call from 43993002 using subscriber '43993002@10.15.18.227' id 295
using caller domain inbound rewrite rule set 'TestDomainRWRSet' with id 1
callee 004312345678 is rewritten based on the inbound rules into 4312345678
caller 43993002 is rejected as it does not match subscriber's 'allowed_clis'
'allowed_cli' reject policy is 'override_by_usernpn'
callee subscriber lookup based on 4312345678
no callee subscriber found, performing peer lookup with caller uri 43993002@10.15.18.227 and ca
llee uri 4312345678 and callee 4312345678
matched peer 'TestPeerGroup1' with id 1
call to 004312345678 and peer host 'TestPeerServer1' (ip: 192.168.1.2) with id 1
using callee peer outbound rewrite rule set 'TestPeerRWRSet' with id 3
caller 43993002 is rewritten based on the outbound rules into +43993002
callee 4312345678 is rewritten based on the outbound rules into +4312345678
```

Figure 34: Call Routing Verif. - Only Numbers - Result

2. Using phone number and URI, without explicit subscriber selection

- Input Data:

Call Routing Verification

[← Back](#) [Expand Groups](#)

Caller number/uri

Callee number/uri

Caller Type Subscriber
 Peer

Caller Subscriber Search: .227

#	Username	Domain	UUID	Number	
295	43993002	10.15.18.227	51e32173-c8a9-44f1-af30-a1ed431eb2bf		<input type="checkbox"/>
297	43993003	10.15.18.227	6feb9ea-21c0-4f55-8828-80d546b8998f		<input type="checkbox"/>
299	43993004	10.15.18.227	3543a26e-861b-459f-a348-a8ef3e1e9eab		<input type="checkbox"/>
301	43993005	10.15.18.227	355773d2-1c08-475c-8858-eaf75bb58c73		<input type="checkbox"/>

Showing 1 to 4 of 8 entries (filtered from 56 total entries) ← 1 2 →

Caller Rewrite Rules Override

Callee Rewrite Rules Override

Callee Peer Override

[Verify](#)

Figure 35: Call Routing Verif. - Number and URI - Input

- Result:

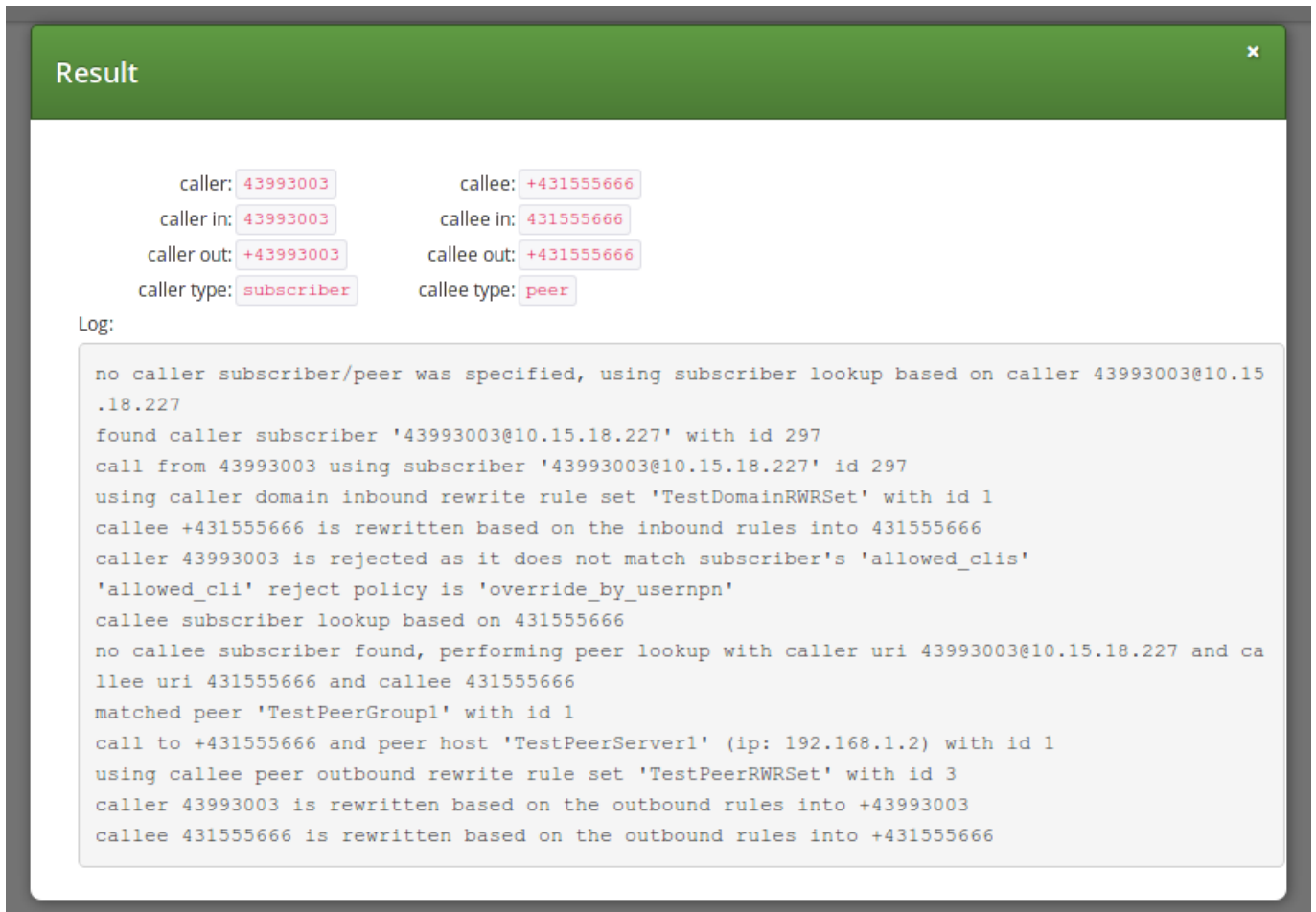

The screenshot shows a window titled "Result" with a green header and a close button. Below the header, there are two columns of call details:

caller:	43993003	callee:	+431555666
caller in:	43993003	callee in:	431555666
caller out:	+43993003	callee out:	+431555666
caller type:	subscriber	callee type:	peer

Below the details is a "Log:" section containing the following text:

```
no caller subscriber/peer was specified, using subscriber lookup based on caller 43993003@10.15.18.227
found caller subscriber '43993003@10.15.18.227' with id 297
call from 43993003 using subscriber '43993003@10.15.18.227' id 297
using caller domain inbound rewrite rule set 'TestDomainRWRSet' with id 1
callee +431555666 is rewritten based on the inbound rules into 431555666
caller 43993003 is rejected as it does not match subscriber's 'allowed_clis'
'allowed_cli' reject policy is 'override_by_usernpn'
callee subscriber lookup based on 431555666
no callee subscriber found, performing peer lookup with caller uri 43993003@10.15.18.227 and callee uri 431555666 and callee 431555666
matched peer 'TestPeerGroup1' with id 1
call to +431555666 and peer host 'TestPeerServer1' (ip: 192.168.1.2) with id 1
using callee peer outbound rewrite rule set 'TestPeerRWRSet' with id 3
caller 43993003 is rewritten based on the outbound rules into +43993003
callee 431555666 is rewritten based on the outbound rules into +431555666
```

Figure 36: Call Routing Verif. - Number and URI - Result

6 Features

The Sipwise C5 provides plenty of subscriber features to offer compelling VoIP services to end customers, and also to cover as many deployment scenarios as possible. In this chapter, we provide the features overview and describe their function and use cases.

6.1 About the Admin Web Interface

This section is going to give some hints to the reader about the Admin web interface of Sipwise C5. The notes here are generic and apply to most of the features that we discuss in the handbook in subsequent chapters.

6.1.1 Filtering the Lists / Databases

When you look at or want to change various settings on Admin web interface you will see datatables or lists of particular items, e.g. Subscribers, Peering Groups, etc. Sometimes this kind of list can be really long and then it's difficult to find the desired item there. To help the system administrator, the Sipwise C5 offers search filters for each of the lists / databases. You have to simply type a search string (arbitrary text) in the *Search* textbox and the system will automatically filter the complete datatable for records that match the search string.

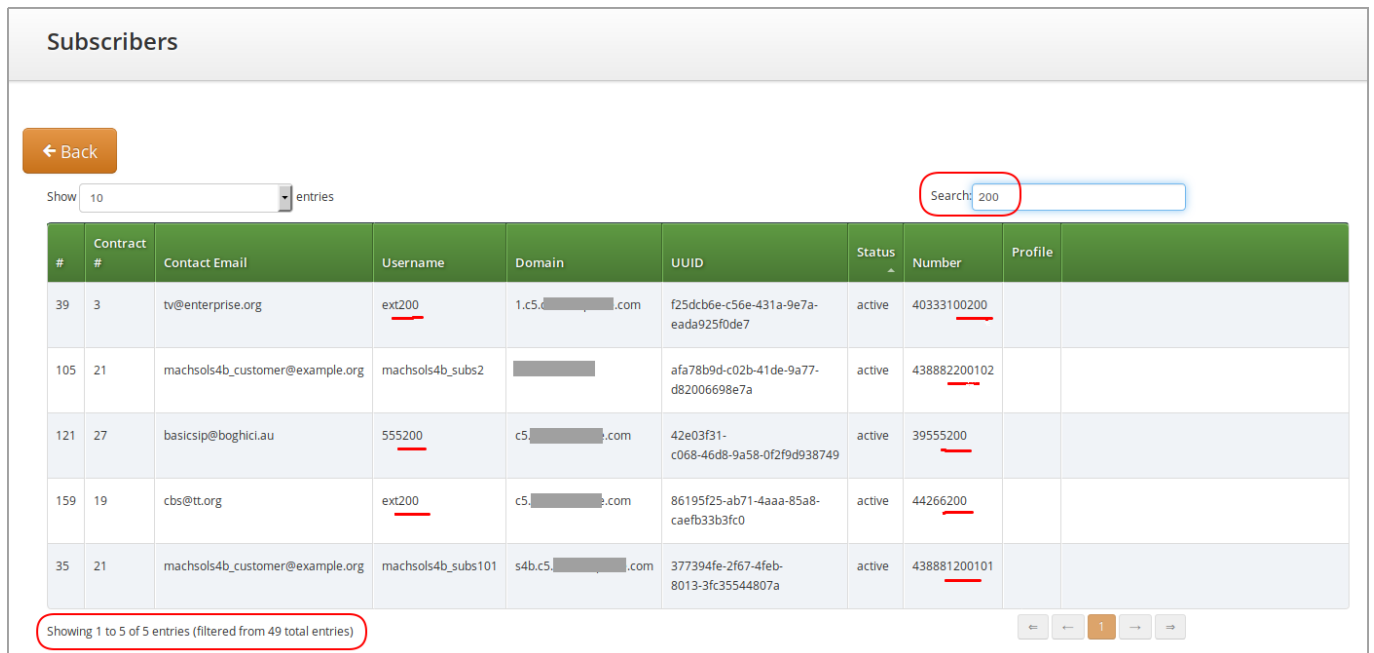

Subscribers

← Back

Show 10 entries

Search: 200

#	Contract #	Contact Email	Username	Domain	UUID	Status	Number	Profile
39	3	tv@enterprise.org	ext200	1.c5.████████.com	f25dc6e-c56e-431a-9e7a-eada925f0de7	active	40333100200	
105	21	machsols4b_customer@example.org	machsols4b_subs2	████████.com	afa78b9d-c02b-41de-9a77-d82006698e7a	active	438882200102	
121	27	basicsip@boghici.au	555200	c5.████████.com	42e03f31-c068-46d8-9a58-0f2f9d938749	active	39555200	
159	19	cbs@tt.org	ext200	c5.████████.com	86195f25-ab71-4aaa-85a8-caefb33b3fc0	active	44266200	
35	21	machsols4b_customer@example.org	machsols4b_subs101	s4b.c5.████████.com	377394fe-2f67-4feb-8013-3fc35544807a	active	438881200101	

Showing 1 to 5 of 5 entries (filtered from 49 total entries)

Figure 37: Filtered List of Subscribers

The Search String

The previous example shows what happens if you type a search string in the *Search* textbox. The search string will be applied to all visible columns of the datatable as a filter and all matching records are kept displayed.

The * symbol can be used as **wildcard** for zero-or-more characters.

Note

The * is prepended and appended implicitly to the string entered in *Search* textbox to make filtering easier, for almost all datatables / lists.

While the search pattern is typically matched to values of all columns visible in the datatable, in some cases (i.e. unindexed columns) may be excluded from searching.

6.1.2 Call History

Each call appears in the subscriber's *Call History*, except globally suppressed ones (if suppressing is configured), and you can apply search filters to the table as in case of other datatables.

The *Call History* datatable behaves slightly differently when it comes to wildcard usage. The * wildcard needs to be entered explicitly by the user if needed.

Call List for machsols4b_subs2@ [REDACTED] (43 888 2200102)

[← Back](#)

Show all calls Search: s4b_int*

Show 10 entries From Date: To Date:

#	Caller	Callee	CLIR	Billing zone	Status	Start Time	Duration	MOS avg	MOS packetloss	MOS jitter	MOS roundtrip	Call-ID	Cost
1505	438882200102	s4b_int432158@ [REDACTED]	0		cancel	2018-08-06 11:27:41.945	0:00:00					d54aec4a71e57db7c38db9e8c8f894e1d	0.00
1507	438882200102	s4b_int31882200101@ [REDACTED]	0		noanswer	2018-08-06 11:28:10.273	0:00:00					d2f5a87577ee338fb326743fb2894e1d	0.00
1509	438882200102	s4b_int31882200101@ [REDACTED]	0	all	ok	2018-08-06 11:29:54.920	0:00:21.891	4.3	0.0	0.0	9999.0	13148ad1d3c16da8eba7dd5443894e1d	0.00
Total							0:00:21.891						0.00

Showing 1 to 3 of 3 entries (filtered from 10 total entries)

Figure 38: Filtered Call History



Caution

Be aware that acceptable response times of the administrative web interface rely on utilizing available database indexes, which is impossible with a leading wildcard in the search string. Wildcards at the end of the search pattern do not impact performance.

6.2 Managing System Administrators

The Sipwise C5 offers the platform operator with an easy to use interface to manage users with administrative privileges. Such users are representatives of resellers, and are entitled to manage configuration of services for *Customers*, *Subscribers*, *Domains*, *Billing Profiles* and other entities on Sipwise C5.

Administrators, as user accounts, are also used for client authentication on the REST API of NGCP.

There are two administrators, whose account is enabled by default. Both of them belong to the *default reseller*. These users are the *superusers* of Sipwise C5 administrative web interface (the so-called "admin panel"), and they have the right to modify administrators of other *Resellers* as well. These users are:

- "administrator" is a default administrative account. It is fully manageable by the system owner.
- "sipwise" is solely for the Sipwise support access. This user can be only enabled or disabled but nor modified neither removed.

6.2.1 Configuring Administrators

Configuration of access rights of system administrators is possible through the admin panel of NGCP. In order to do that, please navigate to *Settings* → *Administrators*.

The screenshot shows the 'Administrators' management page. At the top, there are two buttons: '← Back' and '★ Create Administrator'. The 'Create Administrator' button is circled in red. Below the buttons, a light blue banner displays the message 'Administrator successfully updated'. Underneath, there is a search bar and a dropdown menu set to '5 entries'. The main content is a table with the following columns: #, Reseller, Login, Master, Active, Read Only, Show Passwords, Show CDRs, Show Billing Info, Lawful Intercept, and a set of action buttons. The table contains two rows of data. The second row, for the 'demoadmin' user, has an 'Edit' button circled in red. At the bottom right, there are pagination controls showing 'Showing 1 to 2 of 2 entries' and navigation arrows.

#	Reseller	Login	Master	Active	Read Only	Show Passwords	Show CDRs	Show Billing Info	Lawful Intercept	
1	default	administrator	1	1	0	1	1	1	1	
3	Demo Reseller	demoadmin	1	1	0	1	1	0	0	Edit Delete API key

Figure 39: List of System Administrators

You have 2 options:

- If you'd like to **create** a new administrator user press *Create Administrator* button.
- If you'd like to **update** an existing administrator user press *Edit* button in its row.

There are some generic attributes that have to be set for each administrator:

Edit Administrator
✕

Reseller Search:

#	Name	Contract #	Status	
1	default	1	active	<input checked="" type="checkbox"/>
61	Demo Reseller	243	active	<input type="checkbox"/>

Showing 1 to 2 of 2 entries

Login

Password

Email

Is superuser

Figure 40: Generic System Administrator Attributes

- *Reseller*: each administrator user must belong to a *Reseller*. There is always a default reseller (ID: 1, Name: default), but the administrator has to be assigned to his real reseller, if such an entity (other than default) exists.
- *Login*: the login name of the administrator user
- *Password*: the password of the administrator user for logging in the admin panel, or for authentication on REST API
- *Email*: the email of the administrator user, used for resetting password.

Note

Due to the fact that administrators can request a password reset via email, no administrator is able to change a password or API key other than to himself. Administrators with `is_system`, `is_superuser` and `is_master` flags are the only ones that can change the username and email of other administrators, while the ones without those flags can only change their own email and password.

The second set of attributes is a list of access rights that are discussed in subsequent section of the handbook.

6.2.2 Access Rights of Administrators

The various access rights of administrators are shown in the figure and summarized in the table below.

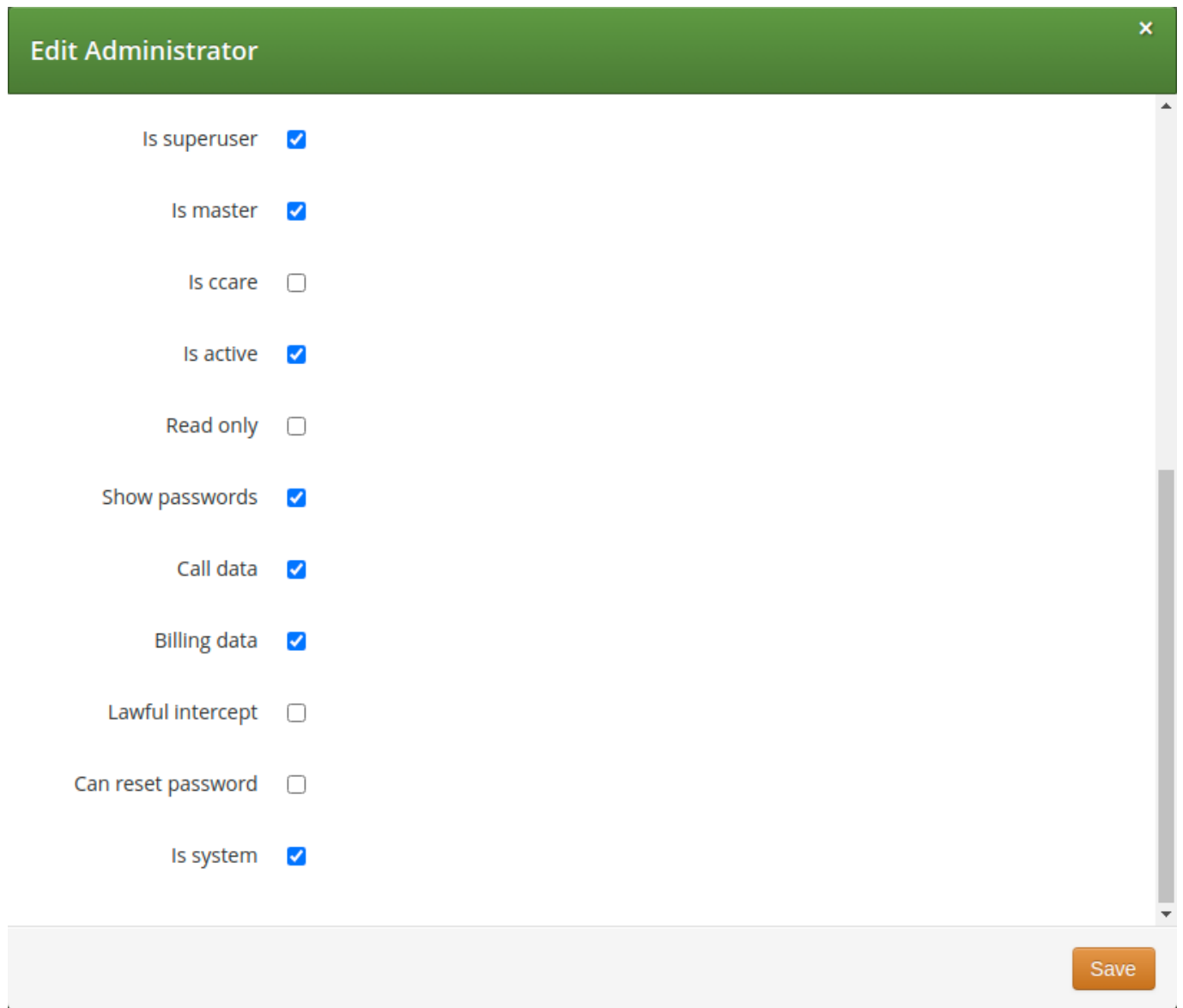

The screenshot shows a dialog box titled "Edit Administrator" with a close button (X) in the top right corner. The dialog contains a list of access rights, each with a checkbox:

- Is superuser
- Is master
- Is ccare
- Is active
- Read only
- Show passwords
- Call data
- Billing data
- Lawful intercept
- Can reset password
- Is system

At the bottom right of the dialog, there is a "Save" button.

Figure 41: Access Rights of System Administrators

Table 1: Access Rights of System Administrators

Label in admin list	Access Right	Description
<i>not shown</i>	Is superuser	The user is allowed to modify data on Reseller level and— among others— is able to modify administrators of other resellers. There should be only 1 user on Sipwise C5 with this privilege.
Master	Is master	The user is allowed to create, delete or modify other Admins who belong to the same Reseller.

Table 1: (continued)

Label in admin list	Access Right	Description
Customer Care	Is ccare	The user is allowed to create, delete or modify Customers and Subscribers. If mixed with Is superuser it defines whether the user can modify the data only within a Reseller the user belongs to, or across all Resellers. The user can access to relevant information required to create or modify Customers or Subscribers, such as Domains, Billing Profiles, Email Templates, but the user cannot access the entries (e.g: see the detailed info about a Billing Profile), nor modify them.
Active	Is active	The user account is active, i.e. the admin user can login on the web panel or authenticate himself on REST API; otherwise user authentication will fail.
Read Only	Read only	The user will only be able to list various data but is not allowed to modify anything. <ul style="list-style-type: none"> • For the web interface this means that <i>Create...</i> and <i>Edit</i> buttons will be hidden or disabled. • For the REST API this means that only <code>GET</code>, <code>HEAD</code>, <code>OPTIONS</code> HTTP request methods are accepted, and Sipwise C5 will reject those targeting data modification: <code>PUT</code>, <code>PATCH</code>, <code>POST</code>, <code>DELETE</code>.
Show Passwords	Show passwords	The user sees subscriber passwords (in plain text) on the web interface. <hr/> <p>Note</p> Admin panel user passwords and subscriber web passwords are stored in an unreadable way (cryptographic hash digest) in the database, while subscriber SIP passwords are stored in plain text. The latter happens on purpose, e.g. to make subscriber data migration possible. <hr/>
Show CDRs	Call data	This privilege has effect on 2 items that will be displayed on admin panel of NGCP, when <i>Subscriber</i> → <i>Details</i> is selected: <ol style="list-style-type: none"> 1. <i>PBX Groups</i> list 2. <i>Captured Dialogs</i> list
Show Billing Info	Billing data	Some REST API resources that are related to billing are disabled: HTTP requests on <code>/api/vouchers</code> , <code>/api/topupcash</code> and <code>/api/topupvoucher</code> resources are rejected.

Table 1: (continued)

Label in admin list	Access Right	Description
Lawful Intercept	Lawful intercept	Visible only for System administrators. If the privilege is selected then the REST API for interceptions (that is: <code>/api/interceptions</code>) is enabled; if the privilege is not selected then the interceptions API is disabled. Administrators with this flag do not have access to anything but the administrators in UI and API and <code>/api/interceptions</code> in the API Note This means that besides enabling LI in <code>config.yml</code> configuration file one also needs to enable the API via the LI privilege of an administrator user, so that Sipwise C5 can really provide LI service.
Can Reset Password	Can Reset Password	The user is allowed to request a password reset.
System	Is system	The user is allowed to create, delete or modify Lawful Intercept Admins which are otherwise invisible to other types of administrators.

6.3 Access Control for SIP Calls

There are two different methods to provide fine-grained call admission control to both subscribers and admins. One is *Block Lists*, where you can define which numbers or patterns can be called from a subscriber to the outbound direction and which numbers or patterns are allowed to call a subscriber in the inbound direction. The other is *NCOS (Network Class of Service) Levels*, where the admin predefines rules for outbound calls, which are grouped in certain levels. The subscriber can then just choose the level, or the admin can restrict a subscriber to a certain level. Also Sipwise C5 offers some options to restrict the IP addresses that subscriber is allowed to use the service from. The following sections describe these features in detail.

6.3.1 Block Lists

Block Lists provide a way to control which users/numbers can call or be called, based on a subscriber level, and can be found in the *Call Blockings* section of the subscriber preferences.

Trusted Sources			
Call Blockings			
	Name	Value	
	block_in_mode	<input type="checkbox"/>	
	block_in_list		
	block_in_clir	<input type="checkbox"/>	
	block_out_mode	<input type="checkbox"/>	
	block_out_list		
	adm_block_in_mode	<input type="checkbox"/>	
	adm_block_in_list		
	adm_block_in_clir	<input type="checkbox"/>	
	adm_block_out_mode	<input type="checkbox"/>	
	adm_block_out_list		
	ncos	<input type="text"/>	

Block Lists are separated into *Administrative Block Lists* (*adm_block_**) and *Subscriber Block Lists* (*block_**). They both have the same behaviour, but Administrative Block Lists take higher precedence. Administrative Block Lists are only accessible by the system administrator and can thus be used to override any Subscriber Block Lists, e.g. to block certain destinations. The following break-down of the various block features apply to both types of lists.

6.3.1.1 Block Modes

Block lists can either be *whitelists* or *blacklists* and are controlled by the User Preferences *block_in_mode*, *block_out_mode* and their administrative counterparts.

- The *blacklist* mode (option is not checked) tells the system to **allow anything except the entries in the list**. Use this mode if you just want to block certain numbers and allow all the rest.
- The *whitelist* mode indicates to **reject anything except the entries in the list**. Use this mode if you want to enforce a strict policy and allow only selected destinations or sources.

You can change a list mode from one to the other at any time.

6.3.1.2 Block Lists

The list contents are controlled by the User Preferences *block_in_list*, *block_out_list* and their administrative counterparts. Click on the *Edit* button in the *Preferences* view to define the list entries.

In block list entries, you can provide shell patterns like `*` and `[]`. The behavior of the list is controlled by the `block_XXX_mode` feature (so they are either allowed or rejected). In our example above we have `block_out_mode` set to `blacklist`, so all calls to US numbers and to the Austrian number `+431234567` are going to be rejected.

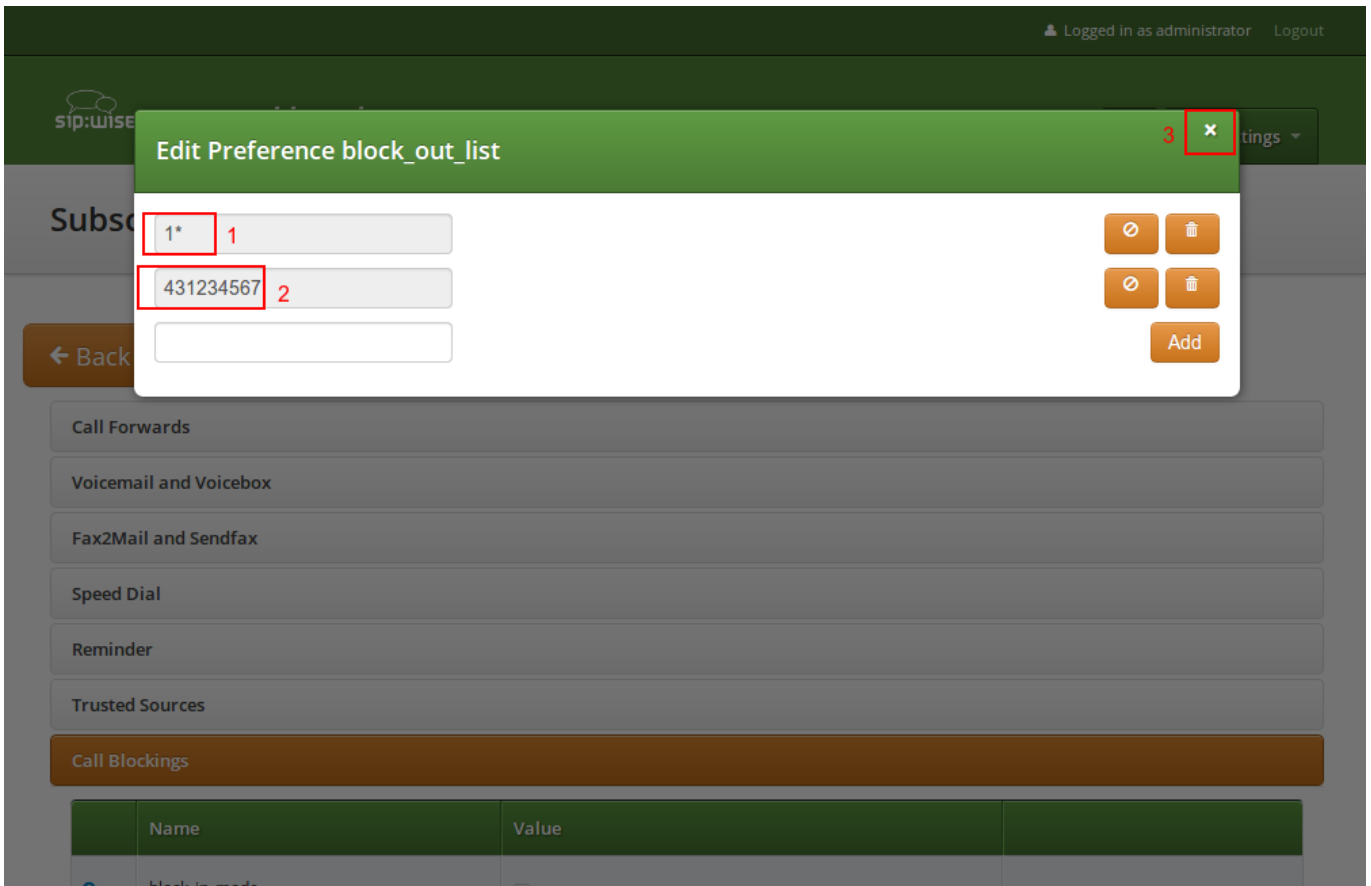

Click the *Close* icon once you're done editing your list.

6.3.1.3 Block Anonymous Numbers

For incoming call, the User Preference `block_in_clir` and `adm_block_in_clir` controls whether or not to reject incoming calls with number suppression (either "[Aa]nonymous" in the display- or user-part of the From-URI or a header `Privacy: id` is set). This flag is independent from the Block Mode.

6.3.2 NCOS (Network Class of Service) Levels

NCOS Levels provide predefined lists of allowed or denied destinations for outbound calls of local subscribers. Compared to *Block Lists*, they are much easier to manage, because they are defined on a global scope, and the individual levels can then be assigned to each subscriber. Again there is the distinction for the user- and administrative- levels.

In a case of a conflict, when the Block Lists feature allows a number and NCOS Levels rejects the same number or vice versa, the call will be rejected.

NCOS levels can either be *whitelists* or *blacklists*.

- The *blacklist* mode indicates to **allow everything except the entries in this level**. Use this mode if you want to block specific destinations and allow all the rest.
- The *whitelist* mode indicates to **reject anything except the entries in this level**. Use this mode if you want to enforce a strict policy and allow only selected destinations.

6.3.2.1 Creating NCOS Levels

To create an NCOS Level, go to *Settings*→*NCOS Levels* and press the *Create NCOS Level* button.

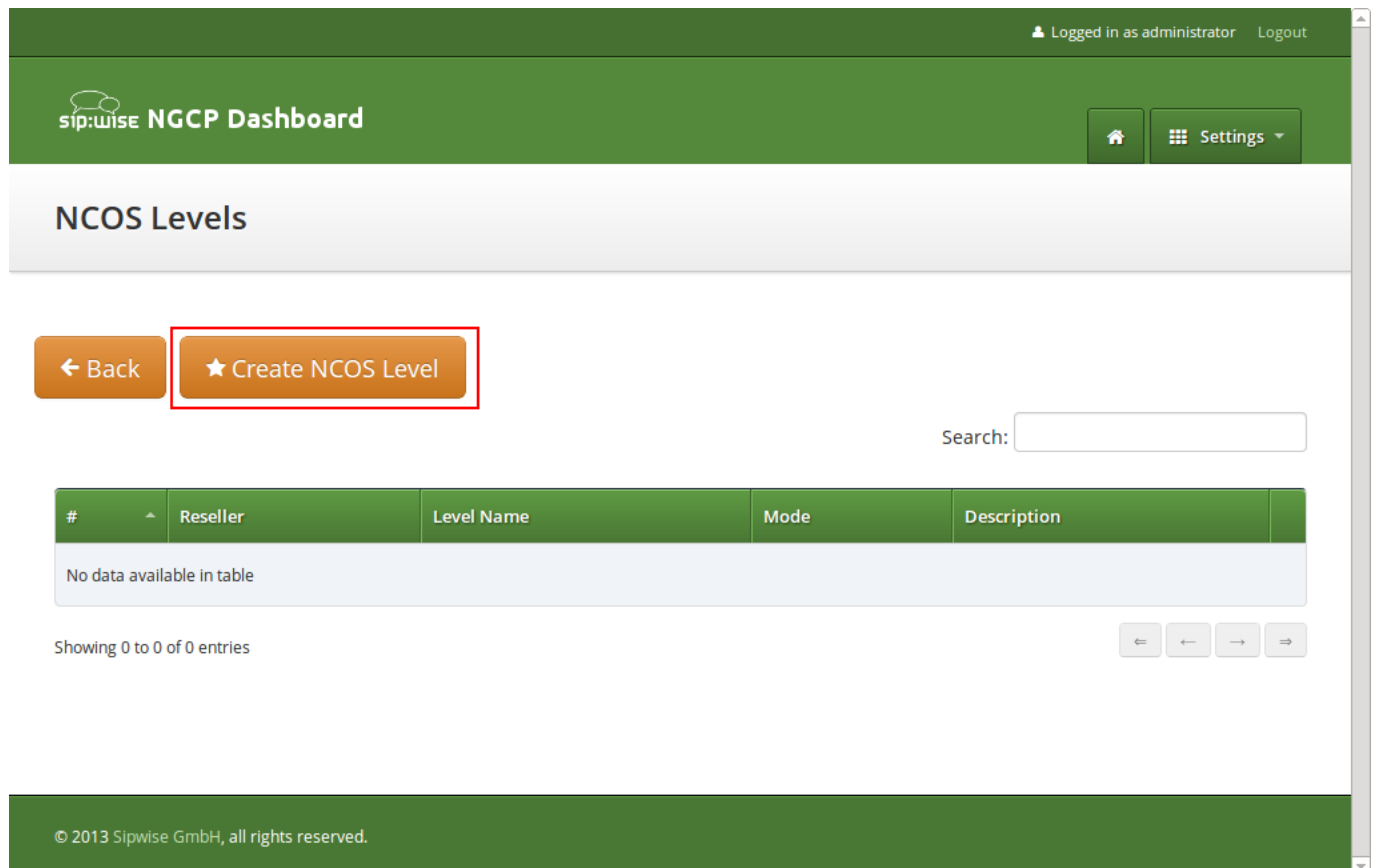

The screenshot shows the Sipwise NGCP Dashboard interface. At the top right, it indicates the user is logged in as an administrator with a 'Logout' link. The dashboard title is 'sip:wise NGCP Dashboard'. Below the title bar, there are navigation icons for home and settings. The main heading is 'NCOS Levels'. Below this heading, there are two buttons: '← Back' and '★ Create NCOS Level'. The 'Create NCOS Level' button is highlighted with a red rectangular box. To the right of the buttons is a search input field labeled 'Search:'. Below the search field is a table with the following columns: '#', 'Reseller', 'Level Name', 'Mode', and 'Description'. The table is currently empty, displaying the message 'No data available in table'. Below the table, it shows 'Showing 0 to 0 of 0 entries' and navigation controls for the table. At the bottom of the dashboard, there is a footer with the text '© 2013 Sipwise GmbH, all rights reserved.'

Select a reseller, enter a name, select the mode and add a description, then click the *Save* button.

Reseller

Search:

#	Name	Contract #	Status	
1	default	1	active	1 <input checked="" type="checkbox"/>

Showing 1 to 1 of 1 entries

Create Reseller

Level Name 2

Mode 3

Description 4

5

© 2013 Sipwise GmbH, all rights reserved.

6.3.2.2 Creating Rules per NCOS Level

To define the rules within the newly created NCOS Level, click on the *Patterns* button of the level.

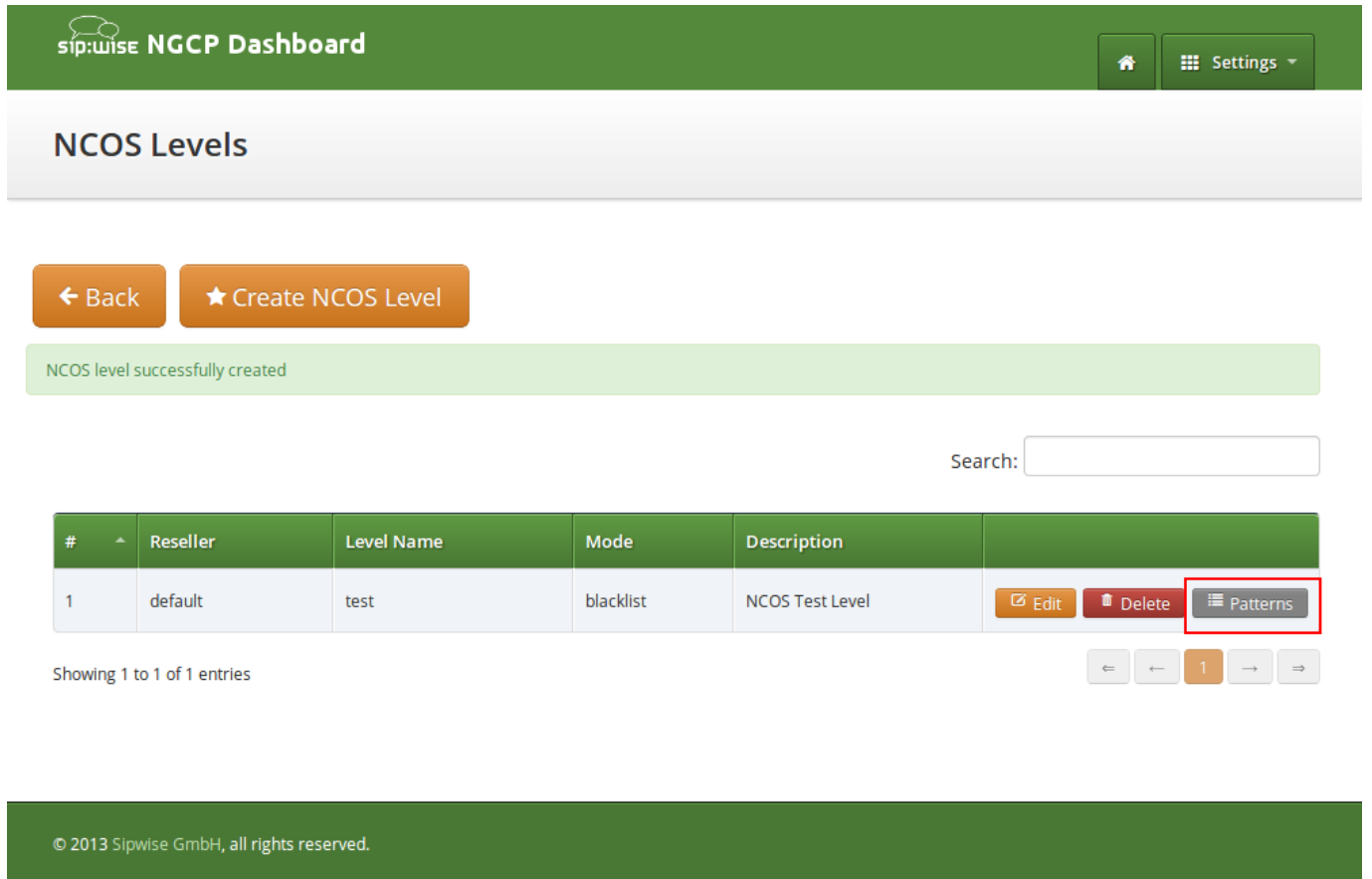

← Back ★ Create NCOS Level

NCOS level successfully created

Search:

#	Reseller	Level Name	Mode	Description	
1	default	test	blacklist	NCOS Test Level	Edit Delete Patterns

Showing 1 to 1 of 1 entries

© 2013 Sipwise GmbH, all rights reserved.

There are 2 groups of patterns where you can define matching rules for the selected NCOS Level:

- **NCOS Number Patterns:** here you can define number patterns that will be matched against the called number and allowed or blocked, depending on whitelist / blacklist mode. The patterns are regular expressions.
- **NCOS LNP Carriers:** here you can select predefined *LNP Carriers* that will be allowed (whitelist mode) or prohibited (blacklist mode) to route calls to them. For each of them you can restrict the matching to a predefined number pattern. (See Section 6.6.1 in the handbook for the description of LNP functionality)

Note

Sipwise C5 performs number matching always with the dialed number and not with the number generated after LNP lookup that is: either the original dialed number prefixed with an LNP carrier code, or the routing number.

The screenshot shows two sections of a web interface. The top section is titled "NCOS Number Patterns" and contains a "Back" button and a "Create Pattern Entry" button. Below these is a success message: "NCOS pattern successfully created". There is a "Show 5 entries" dropdown and a search field. A table lists one entry with ID 1, Pattern "^439", and Description "Austrian Premium Numbers". Below the table are checkboxes for "Include local area code" and "Intra PBX Calls within same customer", and an "Edit" button. The bottom section is titled "NCOS LNP Carriers" and contains a "Create LNP Entry" button. It also has a "Show 5 entries" dropdown and a search field. A table lists one entry with ID 1, LNP Carrier "LNP_Carr1", and Description "Rule for LNP Carrier 1".

Figure 42: NCOS Patterns List

In the **NCOS Number Patterns** view you can create multiple patterns to define your level, one after the other. Click on the *Create Pattern Entry* Button on top and fill out the form.

The screenshot shows a modal window titled "Create Number Pattern". It has a close button in the top right corner. The form contains two input fields: "Pattern" with the value "^439" and "Description" with the value "Austrian Premium Numbers". A "Save" button is located at the bottom right of the form.

Figure 43: Create NCOS Number Pattern

In this example, we block (since the mode of the level is *blacklist*) all numbers starting with 439. Click the *Save* button to save the entry in the level.

There are **2 options** that help you to easily define specific number ranges that will be allowed or blocked, depending on whitelist / blacklist mode:

- *Include local area code*: all subscribers within the caller's local area, e.g. if a subscriber has country-code 43 and area-code 1, then selecting this checkbox would result in the implicit number pattern: 431 .
- *Intra PBX calls within same customer*: all subscribers that belong to the same PBX customer as the caller himself.

In the **NCOS LNP Carriers** view you can select specific LNP Carriers—i.e. carriers that host the called ported numbers—that will be allowed or blocked for routing calls to them (whitelist / blacklist mode, respectively).

An example of *NCOS LNP Carrier* definition:

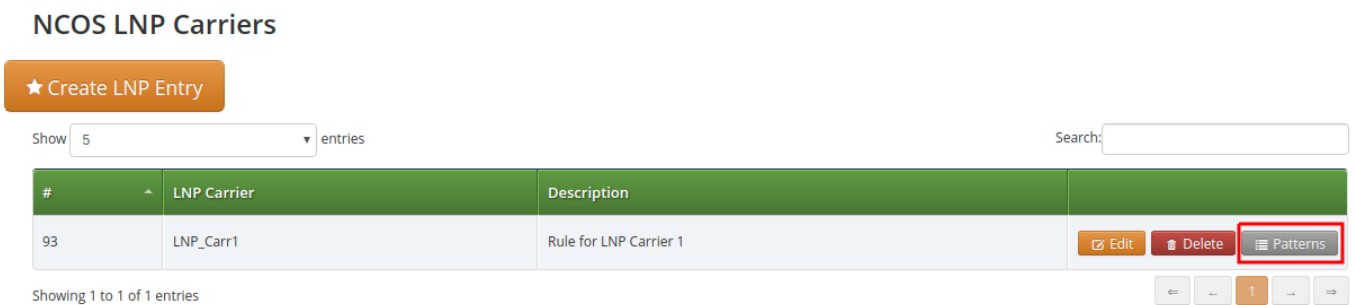

Figure 44: Create NCOS LNP Carrier

In the above example we created a rule that blocks calls to "LNP_Carr1" carrier, supposing we use blacklist mode of the NCOS Level.

In the **LNP NCOS Number Patterns** view you can create multiple patterns to restrict *NCOS LNP Carrier* matching, one after the other. Click on the *Create LNP Pattern Entry* Button on top and fill out the form.

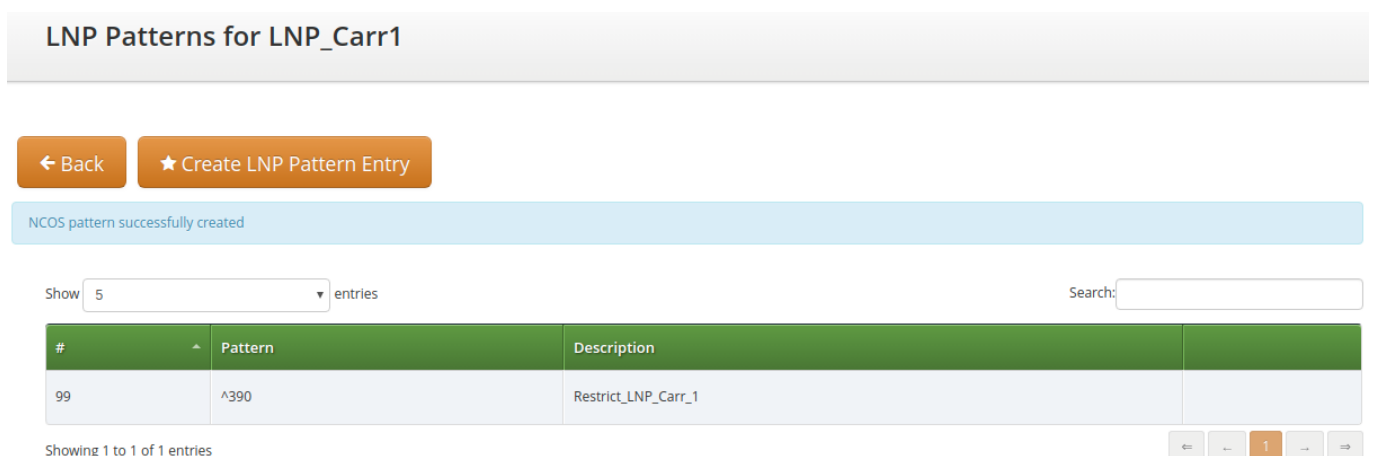

Figure 45: Create NCOS LNP Carrier Pattern

Considering the example before and adding the pattern shown in the picture, the rule now blocks only calls to "LNP_Carr1" carrier

that starts with 390.

Tip

There might be situations when phone number patterns may not be strictly aligned with telephony providers, for instance in case of full number portability in a country. In such cases using *NCOS LNP Carriers* patterns still allows for defining NCOS levels that allow / block calls to mobile numbers, for example. In order to achieve this goal you have to list all LNP carriers in the NCOS patterns that are known to host mobile numbers.

The below table gives an overview of all the possible combinations of *NCOS* and *NCOS LNP Carrier*:

Table 2: NCOS combinations

TYPE	NCOS	NCOS_LNP	RESULT
Whitelist	empty table	empty table	Blocked
Whitelist	empty table	no match	Blocked
Whitelist	empty table	match	Allowed
Whitelist	no match	empty table	Blocked
Whitelist	no match	no match	Blocked
Whitelist	no match	match	Blocked*
Whitelist	match	empty table	Allowed
Whitelist	match	no match	Blocked*
Whitelist	match	match	Allowed
Blacklist	empty table	empty table	Allowed
Blacklist	empty table	no match	Allowed
Blacklist	empty table	match	Blocked
Blacklist	no match	empty table	Allowed
Blacklist	no match	no match	Allowed
Blacklist	no match	match	Blocked
Blacklist	match	empty table	Blocked
Blacklist	match	no match	Blocked
Blacklist	match	match	Blocked

- = different behaviour compared with the previous versions (< mr7.5)

The parameter `kamailio.proxy.lnp.strictly_check_ncos` contained in `/etc/ngcp-config/config.yml` specify whether the NCOS LNP should be evaluated even if the LNP lookup was not previously executed (because not required by the inbound/outbound call) or if it didn't return any occurrence. If set to `yes`, a whitelist NCOS will fail if the LNP lookup doesn't return any match. The parameter has no impact on blacklist NCOS.

6.3.2.3 Assigning NCOS Levels to Subscribers/Domains

Once you've defined your NCOS Levels, you can assign them to local subscribers. To do so, navigate to *Settings*→*Subscribers*, search for the subscriber you want to edit, press the *Details* button and go to the *Preferences* View. There, press the *Edit* button on either the *ncos* or *adm_ncos* setting in the *Call Blockings* section.

1

Name	Value
block_in_mode	<input type="checkbox"/>
block_in_list	
block_in_clir	<input type="checkbox"/>
block_out_mode	<input type="checkbox"/>
block_out_list	1* 431234567
adm_block_in_mode	<input type="checkbox"/>
adm_block_in_list	
adm_block_in_clir	<input type="checkbox"/>
adm_block_out_mode	<input type="checkbox"/>
adm_block_out_list	
ncos	<input type="text" value="ncos"/>

2

3 Edit

You can assign the NCOS level to all subscribers within a particular domain. To do so, navigate to *Settings*→*Domains*, select the domain you want to edit and click *Preferences*. There, press the *Edit* button on either *ncos* or *admin_ncos* in the *Call Blockings* section.

Note: if both domain and subscriber have same NCOS preference set (either *ncos* or *adm_ncos*, or both) the subscriber's preference is used. This is done so that you can override the domain-global setting on the subscriber level.

6.3.2.4 Assigning NCOS Level for Forwarded Calls to Subscribers/Domains

In some countries there are regulatory requirements that prohibit subscribers from forwarding their numbers to special numbers like emergency, police etc. While Sipwise C5 does not deny provisioning Call Forward to these numbers, the administrator can prevent the incoming calls from being actually forwarded to numbers defined in the NCOS list: just select the appropriate NCOS level in the domain's or subscriber's preference *adm_cf_ncos*. This NCOS will apply only to the Call Forward from the subscribers and not to the normal outgoing calls from them.

6.3.3 IP Address Restriction

The Sipwise C5 provides subscriber and domain preference *allowed_ips* to restrict the IP addresses that a particular subscriber or any subscribers within the respective domain is allowed to use the service from. If the REGISTER or INVITE request comes from an IP address that is not in the allowed list, Sipwise C5 will reject it with a 403 message. Also a voice message can be played when the call attempt is rejected (if configured).

By default, *allowed_ips* is an empty list which means that subscriber is not restricted. If you want to configure a restriction, navigate to *Settings*→*Subscribers*→*Preferences* or *Settings*→*Domains*→*Preferences*, and search for the *allowed_ips* preference in the *Access Restrictions* section.

Call Blockings			
Access Restrictions			
1	Name	Value	
?	lock		
?	concurrent_max		
?	concurrent_max_out		
?	allowed_clis		
?	reject_emergency	<input type="checkbox"/>	
?	concurrent_max_per_account		
?	concurrent_max_out_per_account		
?	allowed_ips 2		3 <input type="button" value="Edit"/>
?	man_allowed_ips		
?	ignore_allowed_ips	<input type="checkbox"/>	
?	allow_out_foreign_domain	<input type="checkbox"/>	

Press the Edit button to the right of empty drop-down list.

You can enter multiple allowed IP addresses or IP address ranges one after another. Click the *Add* button to save each entry in the list. Click the *Delete* button if you want to remove some entry.

6.3.4 CLI-based Access Control

The Sipwise C5 provides subscriber preference *upn_block_list* to restrict the CLI that subscriber is allowed to use the service from. If the INVITE request comes with a CLI that is not in the allowed list, Sipwise C5 will reject it with a 403 message. Also a voice message can be played when the call attempt is rejected (if configured).

The restriction is applied to User-Provided Number (UPN) which is obtained from the configurable source based on the setting of

inbound_upn preference in the *Access Restrictions* section in the Domain and/or User preferences, after it has been rewritten with Inbound Rewrite Rules for Caller.

In case the *inbound_upn* preference is set to the "From Display-Name" the UPN value can be alphanumeric so the access control supports the alphanumeric (caller name) matching as well. If the incoming message does not have the Display-Name, though, the UPN value will be taken from the From-Username.

By default, *upn_block_list* is an empty list which means that subscriber is not restricted. If you want to configure a restriction, navigate to *Settings*→*Subscribers*, search for the subscriber you want to edit, press *Details* and then *Preferences* and press *Edit* for the *upn_block_list* preference in the *Call Blockings* section to define the list entries.

In block list entries, you can provide shell patterns like * and []. The CLI-based block list can either be *whitelist* or *blacklist*.

- The *blacklist* mode indicates to **allow everything except the entries in this list**. This is the default mode of operation and is effective when the preference *upn_block_mode* is unset.
- The *whitelist* mode indicates to **reject anything except the entries in this list**. In order to switch to this mode, set the preference *upn_block_mode* (it is a toggle between whitelist/blacklist).

If separate preference *upn_block_clir* is enabled, outgoing anonymous calls from this user will be dropped.

If the caller's UPN is allowed it is also checked according to *allowed_clis* preference as usual and can be rewritten according to *allowed_clis_reject_policy* for correct calling number presentation on outgoing calls. This step happens after Access Control.

6.3.5 Call Limit Control

There's a set of preferences that limits calls to and from subscribers. The option *concurrent_max_total* defines the maximum number of concurrent calls (incoming and outgoing) for a subscriber, while the option *concurrent_max_out_total* limits only subscriber's outbound concurrent calls and the option *concurrent_max_in_total* only subscriber's inbound concurrent calls.

Preferences *concurrent_max*, *concurrent_max_out*, and *concurrent_max_in* have the same effect, excluding calls to voicemail, application server and intra-PBX calls.

It's also possible to limit the number of concurrent calls of a subscriber compared to the number of calls made or received by all subscribers within the same customer (account). The options *concurrent_max_per_account*, *concurrent_max_out_per_account*, *concurrent_max_in_per_account* permit to apply this limit. To better understand how they work, suppose we have two subscribers A and B, owned by the same customer. If we set *concurrent_max_per_account=2* on B preferences and A is placing two calls, then B can not receive or place new calls at the same time. For instance, an administrator may define this restriction to some non-manager subscribers, in which *concurrent_max_per_account=2*. Hence, they will be able to make a maximum of two calls if there are no other calls in place within the customer. On manager subscribers, the limit can be defined differently, or even not set at all. In the last case, calls will be always allowed.

When *concurrent_max_total* limit is reached, announcement set on *max_calls_in* is played to those who try to call that subscriber. The same announcement is played for *concurrent_max*, *concurrent_max_per_account*, *concurrent_max_in_total*, *concurrent_max_in*, *concurrent_max_in_per_account*. When *concurrent_max_out_total* limit is reached, announcement set on *max_calls_out* is played. The same announcement is played for *concurrent_max_out* or *concurrent_max_out_per_account*.

Options *concurrent_max*, *concurrent_max_out* and *concurrent_max_in* are configurable on peers as well.

Furthermore, options *concurrent_max*, *concurrent_max_out*, *concurrent_max_in* and their *_total* version (*concurrent_max_total* and so on), are configurable on customer as well. In this case the limits are applied considering the number of calls of all the subscribers belonging to that account.

6.4 Call Forwarding and Call Hunting

The Sipwise C5 provides the capabilities for normal *call forwarding* (deflecting a call for a local subscriber to another party immediately or based on events like the called party being busy or doesn't answer the phone for a certain number of seconds) and *serial call hunting* (sequentially executing a group of deflection targets until one of them succeeds). Targets can be stacked, which means if a target is also a local subscriber, it can have another call forward or hunt group which is executed accordingly.

6.4.1 Call Forward Types

Currently 7 different types of Call Forward are available in Sipwise C5:

- **Call Forward Unconditional (CFU):** The call forward is always executed, completely disregarding the subscriber state.
- **Call Forward Busy (CFB):** The call forward is executed when the subscriber returns a busy state.
- **Call Forward Timeout (CFT):** The call forward is executed when no answer is received from the subscriber before the timeout expiration. Timeout is configurable in *ringtimeout* subscriber preference.
- **Call Forward Unavailable (CFNA):** The call forward is executed when the subscriber has no endpoint registered.



Caution

The Call Forward Unavailable is also executed if the callee responds with *480 Temporarily Unavailable*, which may be the case when a subscriber's endpoint (e.g. an IP-PBX) is registered but the callee user is not available.

- **Call Forward SMS (CFS):** The SMS forward is always executed, completely disregarding the subscriber state. SMS service has to be enabled, see the [SMS \(Short Message Service\)](#) subchapter for a detailed description on how to activate it.
- **Call Forward on Response (CFR):** The call forward is executed only for particular reply codes received back from the destination endpoint. The list of the reply codes and the activation mode can be configured in *rerouting_codes* and *rerouting_mode* subscriber's preferences. Example: suppose that *rerouting_codes* is set to 503, *rerouting_mode* to whitelist and the CFR is configured. If that subscriber receives a call and it replies back with code 503, then the call will be re-routed to the destination configured in the CFR. For all the other reply codes the CFR will be NOT executed.
- **Call Forward on Overflow (CFO):** The call forward is executed when the new incoming call for the subscriber exceeds the limit configured in *concurrent_max_in_total*, *concurrent_max_in* or *concurrent_max_in_per_account* subscriber's preferences. If none of the preferences is set then the CFO will be NOT executed.

Important

Starting from mr7.2.1 release, **Call Forward on Response (CFR)** has to be configured on the **callee** subscriber (in previous versions the preference was associated to the caller subscriber). When the destination endpoint replies back with an error code, this will be matched with the one listed in the *rerouting_codes* and *rerouting_mode* callee's preferences.

6.4.2 Setting a simple Call Forward

Go to your *Subscriber Preferences* and click *Edit* on the Call Forward Type you want to set (e.g. *Call Forward Unconditional*).

Edit Call Forward Unconditional

Destination

- Voicemail
- Conference
- Fax2Mail
- Custom Announcement
- Manager Secretary
- URI/Number

URI/Number

for (seconds)

Enabled

Advanced View Save

If you select *URI/Number* in the *Destination* field, you also have to set a *URI/Number*. The timeout defines for how long this destination should be tried to ring.

6.4.3 Call Forward Destinations

- **Voicemail:** Calls are forwarded to the Voicemail Application Server where the caller can leave a message.
- **Conference:** Calls are forwarded to the conference room. The subscriber is the host of the conference.
- **Fax2Mail:** Calls are forwarded to the Fax Server and the caller is supposed to leave a fax message. Note: The Fax2Mail feature must be enabled in the subscriber's preferences.

- **Custom Announcement:** A custom announcement is played back to the caller. Select an announcement from the *Custom announcement* list.
- **Manager Secretary:** Calls are forwarded to numbers defined in the "manager_secretary_numbers" subscriber preference. The "manager_secretary" feature must be enabled.
- **URI/Number:** The call is forwarded to the provided SIP-URI string or a number (See the *Call Forward Destination Extra Parameters* section below).

6.4.3.1 Call Forward Destination Options

- **URI/Number:** A destination to forward calls to. This option is only valid for the *URI/Number* destination type. Specify a valid SIP-URI string or a plain number.
- **for (seconds):** Sets the ringing time, after which the call is forwarded to the next number on the list (if configured).
- **Custom Announcement:** Custom Announcements are created in Sound Sets and must have the name like *custom_announcement_0*, where the trailing symbol is a digit from 0 to 9.
- **Enabled:** Defines whether the Call Forward rule is being used or not.

6.4.4 Advanced Call Hunting

Beside call forwarding to a single destination, Sipwise C5 offers the possibility to activate call forwarding in a more sophisticated way:

- to multiple destinations (→ *Destination Set*)
- only during a pre-defined time set (→ *Time Set*)
- only for specific callers (→ *Source Set*)
- only for specific callee (→ *B-Number Set*)

If you want to define such more detailed call forwarding rules, you need to change into the *Advanced View* when editing your call forward. There, you can select multiple *Destination Set - Time Set - Source Set - B-Number Set* groups that determine all conditions under which the call will be forwarded.

Explanation of call forward parameters

- A **Destination Set** is a list of destinations where the call will be routed to, one after another, according to the order of their assigned priorities. See the [Destination Sets](#) subchapter for a detailed description.
- A **Time Set** is a time period definition, i.e. when the call forwarding has to be active. See the [Time Sets](#) subchapter for a detailed description.
- A **Source Set** is a list of number patterns that will be matched against the calling party number; if the calling number matches the call forwarding will be executed. See the [Source Sets](#) subchapter for a detailed description.
- A **B-Number Set** is a list of number patterns that will be matched against the called party number; if the callee number matches the call forwarding will be executed. See the [B-Number Sets](#) subchapter for a detailed description.

6.4.4.1 Configuring Destination Sets

Click on *Manage Destination Sets* to see a list of available sets. The *quickset_cfu* has been implicitly created during our creation of a simple call forward. You can edit it to add more destinations, or you can create a new destination set.

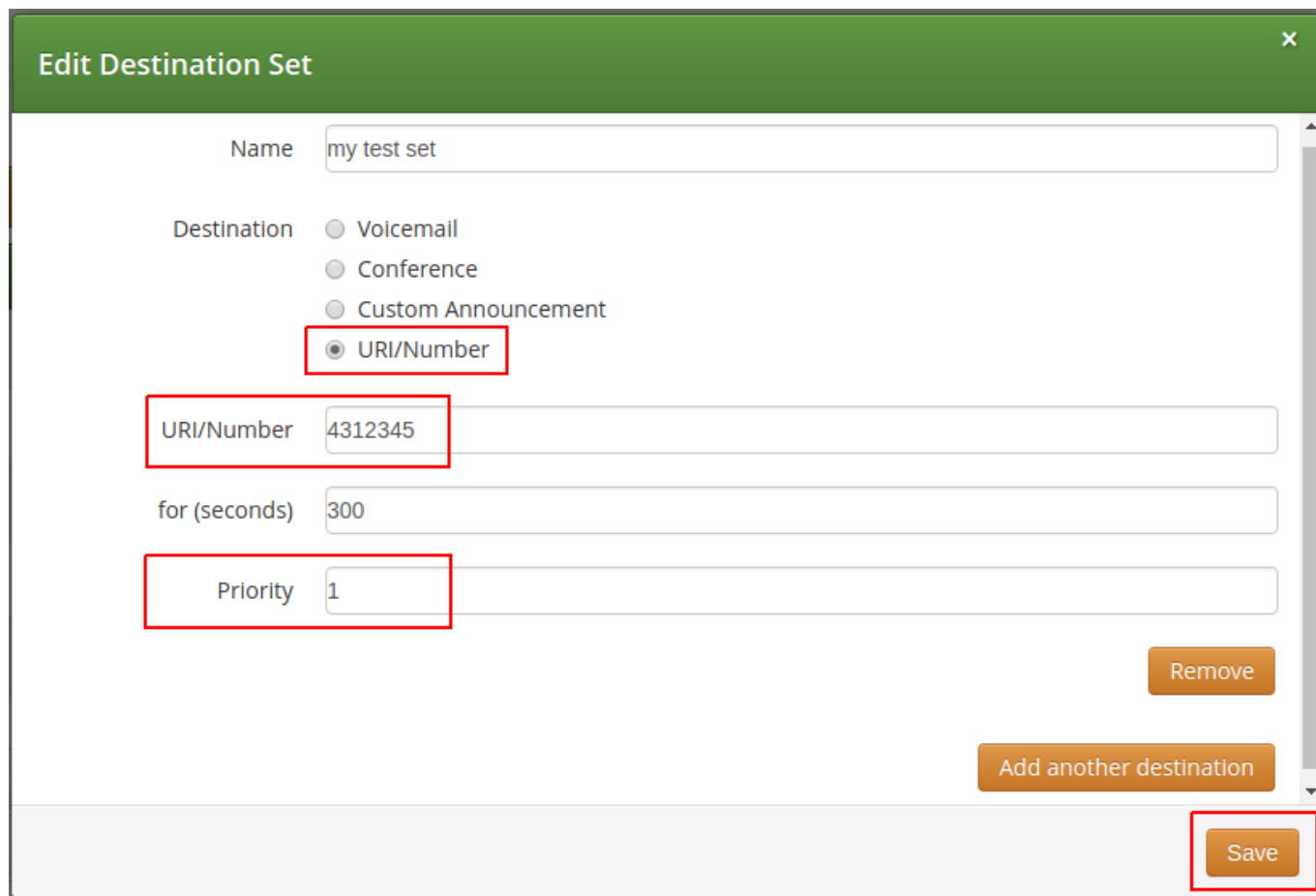

Edit Destination Set [X]

Name

Destination Voicemail
 Conference
 Custom Announcement
 URI/Number

URI/Number

for (seconds)

Priority

When you close the *Destination Set Overview*, you can now assign your new set in addition or instead of the *quickset_cfu* set.

Edit Call Forward Unconditional ✕

during Time Set

from Source Set

to B-Number Set

Destination Set

Enabled

Press *Save* to store your settings.

6.4.4.2 Configuring Time Sets

Click on *Manage Time Sets* in the advanced call-forward menu to see a list of available time sets. By default there are none, so you have to create one.

You need to provide a *Name*, and a list of *Periods* where this set is active. If you only set the top setting of a date field (like the *Year* setting in our example above), then it's valid for just this setting (like the full year of *2013* in our case). If you provide the bottom setting as well, it defines a period (like our *Month* setting, which means from beginning of April to end of September). For example, if a CF is set with the following timeset: "hour { 10-12 } minute { 20-30 }", the CF will be matched within the following time ranges:

- from 10.20am to 10:30am
- from 11.20am to 11:30am
- from 12.20am to 12:30am



Important

the period is a *through* definition, so it covers the full range. If you define an *Hour* definition *8-16*, then this means from *08:00* to *16:59:59* (unless you filter the *Minutes* down to something else).

If you close the *Time Sets* management, you can assign your new time set to the call forwards you're configuring.

6.4.4.3 Configuring Source Sets

Once the *Advanced View* of the call forward definition has been opened, you will need to press the *Manage Source Sets* button to start defining new Source Sets or managing an existing one. The following image shows the Source Set definition dialog:

The screenshot shows the 'Edit Source Set' interface. At the top, there is a green header with a close button (X). Below the header, the form contains the following fields and controls:

- Name:** A text input field containing 'Test Source Number'.
- Mode:** A dropdown menu currently set to 'whitelist'.
- Is regex:** A checkbox that is currently unchecked.
- Source:** A list of source patterns. The first entry is '43*' and the second is '4917655443322'. Each entry has a 'Remove' button to its right.
- Add another source:** A button to add a new source pattern.
- Save:** A button to save the changes.

Figure 46: Creating a Call Forward Source Set

You will need to fill in the `Name` field first, the `Mode: whitelist` or `blacklist`, the `is_regex` flag and finally in the `Source` field you can enter:

- A simple phone number in E.164 format
- A pattern, in order to define a range of numbers. You can use `"*"` (matches a string of 0 to any number of characters), `"?"` (matches any single character), `"[abc]"` (matches a single character that is part of the explicitly listed set: a, b or c) and `"[0-9]"` (matches a single character that falls in the range 0 to 9) as wildcards, as usual in shell patterns. Examples:
 - `"431*"` (all numbers from Vienna / Austria)
 - `"49176[0-5]77*"` (German numbers containing fixed digits and a variable digit in 0-5 range in position 6)
 - `"43130120??"` (numbers from Vienna with fixed prefix and 2 digits variable at the end)
- A perl compatible regular expressions (only if `is_regex` if set). Capturing groups can be formed using parentheses and referenced in the `Destination Set` via `\1, \2, ...`
- The constant string "anonymous" that indicates a suppressed calling number (CLIR)

You can add more patterns to the Source Set by pressing the *Add another source* button. When you finished adding all patterns, press the *Save* button. You will then see the below depicted list of Source Sets:

Name	Mode	Values
Test Source Number	whitelist	43* 4917655443322

Figure 47: List of Call Forward Source Sets

6.4.4.4 Configuring B-Number Sets

Once the *Advanced View* of the call forward definition has been opened, you will need to press the *Manage B-Number Sets* button to start defining new B-Number Sets or managing an existing one. The following image shows the B-Number Set definition dialog:

Name: Test B-Number Set

Mode: whitelist

Is regex:

B-Number: 43993005 [Remove]

B-Number: 4399300510 [Remove]

[Add another B-Number]

[Save]

Figure 48: Creating a Call Forward B-Number Set

You will need to fill in the `Name` field first, the `Mode`: `whitelist` or `blacklist`, the `is_regex` flag and finally in the `B-Number` field you can enter:

- A simple phone number in E.164 format
- A pattern, in order to define a range of numbers. You can use "*" (matches a string of 0 to any number of characters), "?" (matches any single character), "[abc]" (matches a single character that is part of the explicitly listed set: a, b or c) and "[0-9]" (matches a single character that falls in the range 0 to 9) as wildcards, as usual in shell patterns. Examples:
 - "431*" (all numbers from Vienna / Austria)
 - "49176[0-5]77*" (German numbers containing fixed digits and a variable digit in 0-5 range in position 6)
 - "43130120??" (numbers from Vienna with fixed prefix and 2 digits variable at the end)
- A perl compatible regular expressions (only if `is_regex` if set). Capturing groups can be formed using parentheses and referenced in the *Destination Set* via `\1`, `\2`,...

You can add more patterns to the B-Number Set by pressing the *Add another B-Number* button. When you finished adding all patterns, press the *Save* button. You will then see the below depicted list of B-Number Sets:

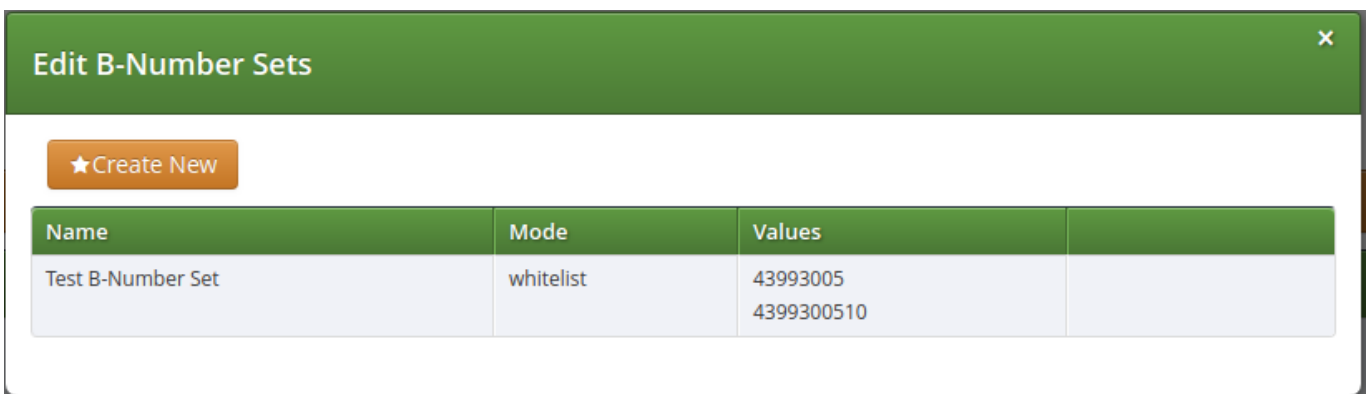

Edit B-Number Sets			
Name	Mode	Values	
Test B-Number Set	whitelist	43993005 4399300510	

Figure 49: List of Call Forward B-Number Sets

6.4.4.5 Finalizing the call forward definition

As additional step you can define a Destination Set as described in [Destination Sets](#) subchapter. For our example, we have defined the following Destination Set:

Edit Destination Sets		
★ Create New		
Name	Values	
my test set	4312345@10.15.18.222	for 300s

Figure 50: List of Call Forward Destination Sets

A final step of defining the call forward settings is selecting a Destination, a Time Set, a Source Set and a B-Number Set, as shown in the image below. *Please note* that there is no specific Time Set selected in our example, that means the call forward rule is valid (as shown) <always>.

during Time Set: <always>
 from Source Set: Test Source Number
 to B-Number Set: Test B-Number Set
 Destination Set: my test set

Remove

Add destination/time sets

Manage Source Sets Manage Destination Sets Manage Time Sets Simple View Save
 Manage B-Number Sets

Figure 51: Definition of a Call Forward with Source and Destination Sets

Once all the settings have been defined and the changes are saved, you will see the call forward entry (in our example: *Call Forward Unconditional*), with the names of the selected Destination, Time Set, Source Sets and B-Number Set provided, at *SubscriberPreferences* → *Call Forwards* location on the web interface:

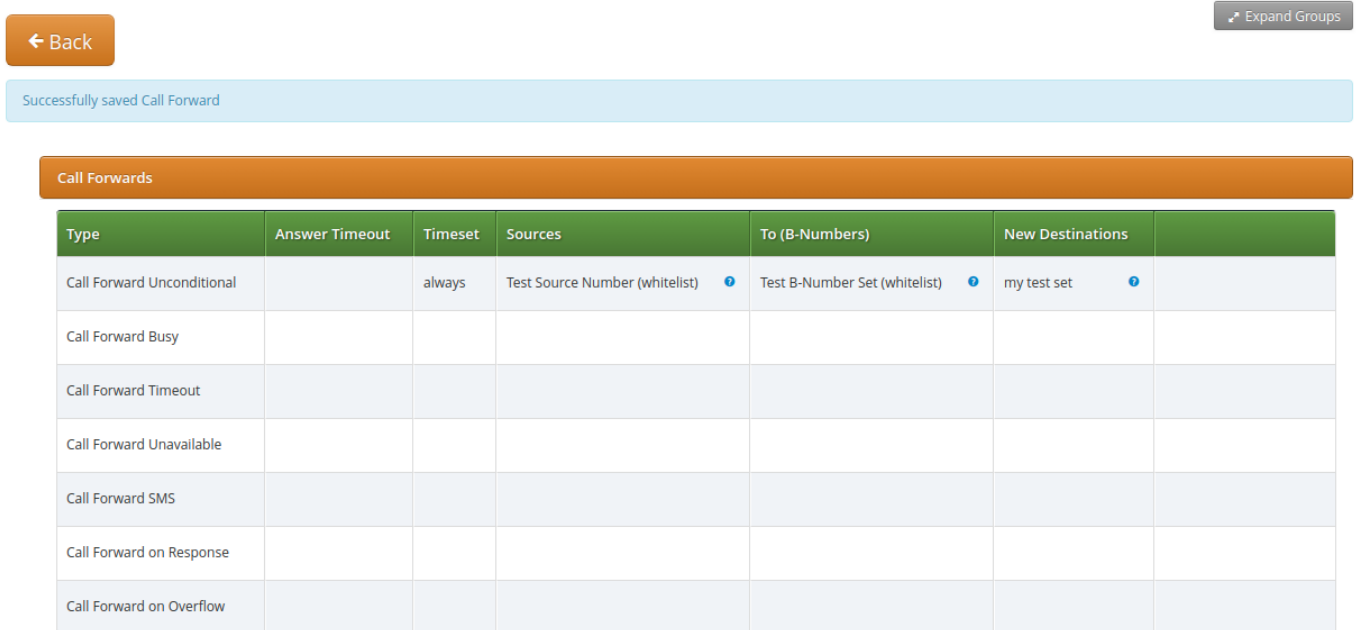

← Back Expand Groups

Successfully saved Call Forward

Type	Answer Timeout	Timeset	Sources	To (B-Numbers)	New Destinations
Call Forward Unconditional		always	Test Source Number (whitelist)	Test B-Number Set (whitelist)	my test set
Call Forward Busy					
Call Forward Timeout					
Call Forward Unavailable					
Call Forward SMS					
Call Forward on Response					
Call Forward on Overflow					

Figure 52: List of Call Forward with Source and Destination Sets

6.5 Call Forking by Q value

The Sipwise C5 platform allows you to register multiple devices under the same subscriber. By the default, the maximum number of the device you can register is 5. This value is configurable via `kamailio`→`proxy`→`max_registrations_per_subscriber` preference in `config.yml`.

If a customer registers multiple devices, Sipwise C5 – once receives a call for that user – just send the call to all the registered devices, in parallel. All the devices will ring at the same time. This is called Parallel Forking, and this is the default behavior. The Sipwise C5 can also do the so-called Serial Forking, which means let ring one device first, then after a timeout let ring the next device, and so on and so forth. The Serial Forking feature can be activated setting subscriber/domain preference `serial_forking_by_q_value`.

6.5.1 The Q value

Serial Forking is based on SIP Contact's parameter called *Q value*, which is basically a priority number, set by the clients during their Registration. The q value is a floating point number in a range 0 to 1.0 specified as a parameter in the Contact header field.

In case the client doesn't set the q value, Sipwise C5 just set a default value of `q=-1` in the database.

Q value can be also specified during the creation of a subscriber's permanent registration (*Details*→*Registered Devices*→*Create Permanent Registration*).

The Sipwise C5 can apply two different type of algorithm to the q values in order to achieve two different types of serial forking called *standard* and *probability*.

6.5.2 The Standard Method

This method uses the q values as a pure priority index. The higher the q value number, the more priority that device has. Contacts with q value 1.0 have maximum priority, so such contacts will be always tried first in serial forking. Contacts with q value 0 have the lowest priority and they will be tried after all other contacts with higher priority.

Note

In case two or more contacts have the same q value, then they are tried in parallel. This allow to create a very flexible mix of Serial and Parallel forking.

This method can be activated setting *Standard* in subscriber/domain preference *serial_forking_by_q_value*.

6.5.3 The Probability Method

This method uses the q values as the weight of the contact. The higher the q value number, the more probability that the device has to ring first. Equals q values means equals probability to be tried. Contacts with q values equals to 0 or lower are not considered by the ordering algorithm, but just added at the end of the list as backup option if all other contacts fail.

Note

Differently from the *standard* method there is no possibility to have parallel forking. This algorithm can be useful to load-balance the calls in case of endpoints in ACTIVE-ACTIVE configuration.

This method can be activated setting *Probability* in subscriber/domain preference *serial_forking_by_q_value*.

6.5.4 Advanced Configurations

If a subscriber with Serial Forking enabled receives a call, Sipwise C5 calls the registered devices one after the another. The forking is stopped only in the following cases:

- there are no more devices to try to contact
- one of the ringing devices answers the call
- one of the ringing devices replies with the SIP code 600, 603, 604, 606 or one of the response codes defined in *stop_forking_code_lists* subscriber/domain preference.
- a Call Forward on Timeout is set and the ringtimeout is reached.

Sipwise C5 allows you also to define how long each single device has to ring during a Serial Forking call. To do that just set the subscriber/domain preference *contact_ringtimeout* to the desired value.

Note

In case both *contact_ringtimeout* and Call Forward on Timeout are configured, CFT timeout has higher priority. To clarify this concept, please take a look at the following examples: Case 1: CFT timeout lower than the total ringtimeout of the contacts. For example: CFT timeout = 100, *contact_ringtimeout* = 40 and 3 devices registered: 1st device will ring for 40 seconds, 2nd device will ring for other 40 seconds, 3rd device will ring only for 20 seconds because of the CFT. Case 2: CFT timeout higher than the total ringtimeout of the contacts. For example: CFT timeout = 100, *contact_ringtimeout* = 40 and 2 devices registered: 1st device will ring for 40 seconds, 2nd device will ring till reaching the CFT timeout (60 seconds in this case).

6.6 Local Number Porting

The Sipwise C5 platform comes with two ways of accomplishing local number porting (LNP):

- one is populating the integrated LNP database with porting data,
- the other is accessing external LNP databases via the Sipwise LNP daemon using the LNP API.

Note

Accessing external LNP databases is available for PRO and CARRIER products only.

6.6.1 Local LNP Database

The local LNP database provides the possibility to define LNP Carriers (the owners of certain ported numbers or number blocks) and their corresponding LNP Numbers belonging to those carriers. It can be configured on the admin panel in *Settings*→*Number Porting* or via the API. The LNP configuration can be populated individually or via CSV import/export both on the panel and the API.

6.6.1.1 LNP Carriers

LNP Carriers are defined by an arbitrary *Name* for proper identification (e.g. *British Telecom*) and contain a *Prefix* which can be used as routing prefix in LNP Rewrite Rules and subsequently in Peering Rules to route calls to the proper carriers. The LNP prefix is written to CDRs to identify the selected carrier for post processing and analytics purposes of CDRs. LNP Carrier entries also have an *Authoritative* flag indicating that the numbers in this block belong to the carrier operating Sipwise C5. This is useful to define your own number blocks, and in case of calls to those numbers reject the calls if the numbers are not assigned to local subscribers (otherwise they would be routed to a peer, which might cause call loops). Finally the *Skip Rewrite* flag skips executing of LNP Rewrite Rules if no number manipulation is desired for an LNP carrier.

6.6.1.2 LNP Numbers

LNP Carriers contain one or more LNP Numbers. Those LNP Numbers are defined by a *Number* entry in E164 format (*<cc><ac><sn>*) used to match a number against the LNP database. Number matching is performed on a longest match, so you can define number

blocks without specifying the full subscriber number (e.g. a called party number *431999123* is going to match an entry *431999* in the LNP Numbers).

For an LNP Numbers entry, an optional *Routing Number* can be defined. This is useful to translate e.g. premium 900 or toll-free 800 numbers to actual routing numbers. If a Routing Number is defined, the called party number is implicitly replaced by the Routing Number and the call processing is continued with the latter. For external billing purposes, the optional *Type* tag of a matched LNP number is recorded in CDRs.

An optional *Start Date* and *End Date* makes it possible to schedule porting work-flows up-front by populating the LNP database with certain dates, and the entries are only going to become active with those dates. Empty values for start indicate a start date in the past, while empty values for end indicate an end time in the future during processing of a call, allowing to define infinite date ranges. As intervals can overlap, the LNP number record with a start time closest to the current time is selected.

6.6.1.3 Enabling local LNP support

In order to activate Local LNP during routing, the feature must be activated in *config.yml*. Set *kamailio→proxy→Inp→enable* to *yes* and *kamailio→proxy→Inp→type* to *local*.

6.6.1.4 LNP Routing Procedure

When a call arrives at the system, the calling and called party numbers are first normalized using the *Inbound Rewrite Rules for Caller* and *Inbound Rewrite Rules for Callee* within the rewrite rule set assigned to the calling party (a local subscriber or a peer).

If the called party number is not assigned to a local subscriber, or if the called party is a local subscriber and has the subscriber/-domain preference *Inp_for_local_sub* set, the LNP lookup logic is engaged, otherwise the call proceeds without LNP lookup. The further steps assume that LNP is engaged.

If the call originated from a peer, and the peer preference *caller_Inp_lookup* is set for this peer, then an LNP lookup is performed using the normalized calling party number. The purpose for that is to find the LNP prefix of the calling peer, which is then stored as *source_Inp_prefix* in the CDR, together with the selected LNP number's *type* tag (*source_Inp_type*). If the LNP lookup does not return a result (e.g. the calling party number is not populated in the local LNP database), but the peer preference *default_Inp_prefix* is set for the originating peer, then the value of this preference is stored in *source_Inp_prefix* of the CDR.

Next, an LNP lookup is performed using the normalized called party number. If no number is found (using a longest match), no further manipulation is performed.

If an LNP number entry is found, and the *Routing Number* is set, the called party number is replaced by the routing number. Also, if the *Authoritative* flag is set in the corresponding LNP Carrier, and the called party number is not assigned to a local subscriber, the call is rejected. This ensures that numbers allocated to the system but not assigned to subscribers are dropped instead of routed to a peer.

Important

If the system is serving a local subscriber with only the routing number assigned (but not e.g. the premium number mapping to this routing number), the subscriber will not be found and the call will either be rejected if the called party premium number is within an authoritative carrier, or the call will be routed to a peer. This is due to the fact that the subscriber lookup is performed with the dialled number, but not the routing number fetched during LNP. So make sure to assign e.g. the premium number to the local subscriber (optionally in addition to the routing number if necessary using alias numbers) and do not use the LNP routing number mechanism for number mapping to local subscribers.

Next, if the LNP carrier does not have the *Skip Rewriting* option set, the *LNP Rewrite Rules for Callee* are engaged. The rewrite rule set used is the one assigned to the originating peer or subscriber/domain via the *rewrite_rule_set* preference. The variables available in the match and replace part are, beside the standard variables for rewrite rules:

- `${callee_lnp_prefix}`: The prefix stored in the LNP Carrier
- `${callee_lnp_basenum}`: The actual number entry causing the match (may be shorter than the called party number due to longest match)

Typically, you would create a rewrite rule to prefix the called party number with the *callee_lnp_prefix* by matching `^([0-9]+)$` and replacing it by `${callee_lnp_prefix}\1`.

Once the LNP processing is completed, the system checks for further preferences to finalize the number manipulation. If the originating local subscriber or peer has the preference *lnp_add_npdi* set, the Request URI user-part is suffixed with `;npdi`. Next, if the preference *lnp_to_rn* is set, the Request URI user-part is suffixed with `;rn=LNP_ROUTING_NUMBER`, where *LNP_ROUTING_NUMBER* is the *Routing Number* stored for the number entry in the LNP database, and the originally called number is kept in place. For example, if *lnp_to_rn* is set and the number *1800123* is called, and this number has a routing number *1555123* in the LNP database, the resulting Request-URI is `sip:1800123;rn=1555123@example.org`.

Finally, the *destination_lnp_prefix* in the CDR table is populated either by the prefix defined in the Carrier of the LNP database if a match was found, or by the *default_lnp_prefix* preference of the destination peer or subscriber/domain.

6.6.1.5 Blocking Calls Using LNP Data

The Sipwise C5 provides means to allow or block calls towards ported numbers that are hosted by particular LNP carriers. Please visit Section [6.3.2.2](#) in the handbook to learn how this can be achieved.

6.6.1.6 Transit Calls using LNP

If a call originated from a peer and the peer preference *force_outbound_calls_to_peer* is set to *force_nonlocal_lnp* (the *if callee is not local and is ported* selection in the panel), the call is routed back to a peer selected via the peering rules.

This ensures that if a number once belonged to your system and is ported out, but other carriers are still sending calls to you (e.g. selecting you as an anchor network), the affected calls can be routed to the carrier the number got ported to.

6.6.1.7 CSV Format

The LNP database can be exported to CSV, and in the same format imported back to the system. On import, you can decide whether to drop existing data prior to applying the data from the CSV.

The CSV file format contains the fields in the following order:

Table 3: LNP CSV Format

Name	Description
Carrier Name	The <i>Name</i> in the LNP Carriers table (string, e.g. <i>My Carrier</i>)
Carrier Prefix	The <i>Prefix</i> in the LNP Carriers table (string, e.g. <i>DD55</i>)
Number	The <i>Number</i> in the LNP Numbers table (E164 number, e.g. <i>1800666</i>)
Routing Number	The <i>Routing Number</i> in the LNP Numbers table (E164 number or empty, e.g. <i>1555666</i>)
Start	The <i>Start</i> in the LNP Numbers table (YYYY-MM-DD or empty, e.g. <i>2016-01-01</i>)
End	The <i>End</i> in the LNP Numbers table (YYYY-MM-DD or empty, e.g. <i>2016-12-30</i>)
Authoritative	The <i>Authoritative</i> flag in the LNP Carriers table (0 or 1)
Skip Rewrite	The <i>Skip Rewrite</i> flag in the LNP Carriers table (0 or 1)
Type	The <i>Type</i> tag in the LNP Numbers table (alphanumeric string, e.g. <i>mobile</i>)

6.6.1.8 Local LNP returned values

If a match in the local LNP table is found corresponding LNP Carrier code will be stored in CDR data.

Additionally two dedicated headers can be added to the outgoing SIP message:

- `P-NGCP-LNP-Number`: The returned LNP number, if any
- `P-NGCP-LNP-Status`: The LNP query return code (200 if successful, 404 if no entry found)

This feature is not enabled by default, but can be activated with the following parameters:

- `kamailio→proxy→lnp→add_reply_headers→enable` : *no*
- `kamailio→proxy→lnp→add_reply_headers→number` : *P-NGCP-LNP-Number*
- `kamailio→proxy→lnp→add_reply_headers→status` : *P-NGCP-LNP-Status*

6.6.2 External LNP via LNP API

External LNP relies on the *NGCP LNP Daemon* (*ngcp-lnpd*) which kamailio-proxy is talking to via a defined JSONRPC protocol. The proxy sends the A and B number to *ngcp-lnpd*, which in the current release translates it to a SIP Message sent to an external server (typically a Squire SIP-to-INAP gateway). This external gateway is performing an SS7 INAP request to fetch the LNP result, which is passed back as a binary blob in a 3xx response to the *ngcp-lnpd*. The *ngcp-lnpd* extracts the TCAP body of the response and returns the information back to the proxy.

6.6.2.1 Enabling LNP lookup via API

In order to activate LNP lookup via API during call routing, the feature must be activated in `/etc/ngcp-config/config.yml`. Set these parameters:

- `kamailio→proxy→lnp→enable` : *yes*
- `kamailio→proxy→lnp→type` : *api*
- `lnpd→enable` : *yes*

There is a possibility to explicitly allow (whitelist) or deny (blacklist) certain number ranges for which an LNP lookup may be done. The relevant configuration parameters are at `kamailio→proxy→lnp→lnp_request_whitelist` and `kamailio→proxy→lnp→lnp_request_blacklist`. For each entry in the list a POSIX regex expression may be used, see the following example:

```
lnp:
  lnp_request_whitelist:
    - '^9'
    - '^800'
  lnp_request_blacklist:
    - '^1'
    - '^900'
    - '^110'
    - '^112'
```

Interpretation of the above lists (that are based on numbers represented in national format):

- **whitelist:** *do* LNP lookup for any called number that starts with *9* or *800*
- **blacklist:** *do not* perform LNP lookup for any called number that starts with *1*, *900*, *110* or *112*



Important

If both whitelist and blacklist are defined, the LNP lookup is only performed when the called number matches any of the whitelist patterns and does not match any of the blacklist patterns.

6.6.2.2 Refine LNP and FCI decoding

Preconfigured parameters should already make it possible to correctly decode the LNP number and FCI code contained in the received TCAP body. If the external server replies with a non-standard TCAP body, it is possible to fine tune the information extraction. Edit the following parameters in order to point to the correct fields:

- `kamailio→proxy→lnp→api→tcap_field_lnp`: `ConnectArg.destinationRoutingAddress.0`
- `kamailio→proxy→lnp→api→tcap_field_opcode`: `end.components.0.invoke.opCode`
- `kamailio→proxy→lnp→api→tcap_field_fci`: `end.components.0.invoke.parameter`

6.6.2.3 The Redundancy Feature

It is possible to set up *LNP daemon* to provide a kind of redundant service to the Proxy. This means the *LNP daemon* will send its LNP query to more LNP serving nodes that are predefined in a list. (See [Configuration of LNP daemon](#) chapter for details.) The LNP query may happen in 2 ways:

- **round-robin**: *LNP daemon* sends the query to one of the serving nodes then waits for the response for a configurable timeout. If it does not get the response in time, it sends the LNP query to the next serving node.
- **parallel**: *LNP daemon* sends the query to all of the serving nodes then waits for the response, and will accept the first response that it receives.

6.6.2.4 Configuration of Sipwise LNP Daemon

LNP daemon takes its active configuration from `/etc/ngcp-lnpd/config.yml` file. The file is generated automatically —when a new Sipwise C5 configuration is applied (`ngcpcfg apply...`)—from the main Sipwise C5 configuration file: `/etc/ngcp-config/config.yml` and a template: `/etc/ngcp-config/template/etc/ngcp-lnpd/config.yml.t`. System administrators are only expected to modify the `lnpd.config` section of main configuration file `/etc/ngcp-config/confi`.

A sample *LNP daemon* configuration file (`/etc/ngcp-lnpd/config.yml`) looks like:

```
daemon:
  json-rpc:
    ports:
      - 54321
      - 12345
    interfaces:
      - 127.0.0.1
      - 192.168.1.90
      - ::1

  sip:
    port: 5095
    address: 0.0.0.0
```

```
threads: 4
foreground: false
pidfile: /run/ngcp-lnpd.pid
loglevel: 7

instances:
  default:
    module: sigtran
    destination: 192.168.1.99
    from-domain: test.example.com
    headers:
      - header: INAP-Service-Key
        value: 2
    reply:
      tcap: raw-tcap
  redundant:
    module: sigtran
    destinations:
      - 192.168.1.99
      - 192.168.1.95
      - 192.168.1.90
    mechanism: round-robin
    retry-time: 30
    timeout: 5
    from-domain: test.example.com
    headers:
      - header: INAP-Service-Key
        value: 2
    reply:
      tcap: raw-tcap
  parallel:
    module: sigtran
    destinations:
      - 192.168.1.99
      - 192.168.1.95
      - 192.168.1.90
    mechanism: parallel
    retry-time: 30
    timeout: 10
    from-domain: test.example.com
    headers:
      - header: INAP-Service-Key
        value: 2
    reply:
      tcap: raw-tcap
  mock1:
    module: mock-tcap
```

```

numbers:
  - number: '4311003'
    routing-number: '4318881003'
reply:
  tcap: raw-tcap

```

The corresponding Sipwise C5 main configuration file contains:

```

daemon:
  foreground: 'false'
  json-rpc:
    ports:
      - '54321'
      - '12345'
  loglevel: '7'
  sip:
    port: '5095'
  threads: '4'
instances:
<< These are the same entries as in /etc/ngcp-lnpd/config.yml file >>

```

Description of configuration parameters in `/etc/ngcp-config/config.yml` file

- **daemon section:**
 - `foreground`: determines if the LNP daemon runs as foreground or background process
 - `json-rpc.ports`: port numbers where LNP daemon listens for incoming JSONRPC requests from Sipwise C5 Proxy
 - `loglevel`: how detailed information LNP daemon writes in its log file
 - `sip.port`: listening port number used for SIP sessions with LNP serving nodes; LNP daemon will listen on first available (shared) IP address that is taken from `/etc/ngcp-config/network.yml` file
 - `threads`: number of threads LNP daemon will use internally; this value determines how many requests the daemon can serve in parallel
- **instances section:** at least one `default` instance must be defined here. Others are also useful for providing redundancy, please check `redundant` and `parallel` entries above.
 - `module`: only `sigtran` is used for normal operations

Important



The module `mock-tcap` is only meant for developers. In this case the LNP daemon does not produce a SIP request that it sends to LNP serving nodes, but instead it uses the `numbers` parameter to match a called number with a routing number. The `numbers` parameter contains a list of number—routing-number pairs and is used as a database for number lookups. Finally LNP daemon returns the routing number as a response on LNP query.

- `destinations`: list of nodes to which LNP daemon sends the LNP query

- `mechanism`: either `parallel` or `round-robin`, defining the method of redundant queries
- `retry-time`: a period of time in seconds while LNP daemon considers an LNP serving node being unreachable after an LNP query timeout
- `timeout`: the period of time while LNP daemon waits for a response on an LNP query from one of the LNP serving nodes
PLEASE NOTE: `retry-time` and `timeout` are used with both the `parallel` and the `round-robin` redundancy methods
- `from-domain`: the domain that will be used in SIP *From* header when LNP daemon sends the LNP query
- `headers`: this is a list of `header name—value` pairs; these custom headers will be included in SIP request that LNP daemon sends to an LNP serving node
- `reply.tcap`: determines the format of reply sent to Sipwise C5 Proxy; currently only `raw-tcap` is supported, which means LNP daemon will not decode the TCAP response it gets from an LNP serving node but it forwards the raw TCAP message body

6.6.2.5 Selection of Sipwise LNP Daemon Instances

By default the instance with name `default` is used for all the lnp queries. To dynamically select which instance use, or to completely skip the lnp query for a particular call, the lnp api module is looking into the SIP message for the header with name *P-NGCP-Lnpd_Instance*:

- if present and not empty, the instance with the name equal to the header content is used
- if present but empty, the lnp api lookup is skipped
- if not present, the `default` instance is used

6.6.2.6 LNP API returned values

As for Local LNP, the LNP number and the FCI code are stored in CDR data.

Additionally two dedicated headers can be added to the outgoing SIP message:

- *P-NGCP-LNP-Number*: The returned LNP number, if any
- *P-NGCP-LNP-Status*: The LNP query return code (200 if successful, 404 if no entry found, 408 in case of connection timeout or 500 if another general error happens)

This feature is not enabled by default, but can be activated with the following parameters:

- `kamailio→proxy→lnp→add_reply_headers→enable` : *no*
- `kamailio→proxy→lnp→add_reply_headers→number` : *P-NGCP-LNP-Number*
- `kamailio→proxy→lnp→add_reply_headers→status` : *P-NGCP-LNP-Status*

6.7 Emergency Mapping

As opposed to the [Simple Emergency Number Handling](#) solution, Sipwise C5 supports an advanced emergency call handling method, called *emergency mapping*. The main idea is: instead of obtaining a statically assigned emergency prefix / suffix from subscriber preferences, Sipwise C5 retrieves an emergency routing prefix from a central emergency call routing table, according to the current location of the calling subscriber.

The following figure shows the overview of emergency call processing when using *emergency mapping* feature:

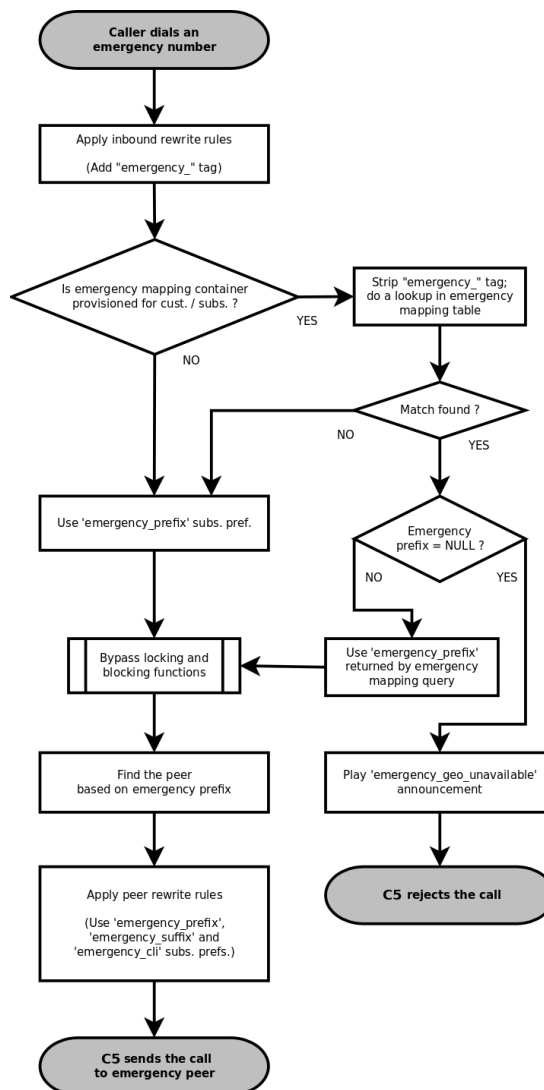

Figure 53: Emergency Call Handling with Mapping

6.7.1 Emergency Mapping Description

Emergency numbers per geographic location are mapped to different routing prefixes not deriveable from an area code or the emergency number itself. This is why a **global emergency mapping table** related to resellers is introduced, allowing to map emergency numbers to their geographically dependent routing numbers.

The geographic location is referenced by a location ID, which has to be populated by a north-bound provisioning system. No towns, areas or similar location data is stored on Sipwise C5 platform. The locations are called *Emergency Containers* on NGCP.

The actual emergency number mapping is done per location (per *Emergency Container*), using the so-called *Emergency Mapping* entries. An *Emergency Mapping* entry assigns a routing prefix, valid only in a geographic area, to a generic emergency number (for example 112 in Europe, 911 in the U.S.A.) or a country specific one (for example 133).

Note

As of mr4.5 version, Sipwise C5 performs an exact match on the emergency number in the emergency routing table.

Emergency Containers may be assigned to various levels of the client hierarchy within NGCP. The following list shows such levels with each level overriding the settings of the previous one:

1. Customer or Domain
2. Customer Location, which is a territory representing a subset of the customer's subscribers, defined as one or more IP subnets.
3. Subscriber

Note

Please be aware that *Customer Location* is not necessarily identical to the "location" identified through an *Emergency Container*.

Once the emergency routing prefix has been retrieved from the emergency mapping table, call processing continues in the same way as in case of simple emergency call handling.

6.7.2 Emergency Mapping Configuration

The administrative web panel of Sipwise C5 provides the configuration interface for emergency mapping. Please navigate to *Settings* → *Emergency Mapping* menu item first, in order to start configuring the mapping.

An *Emergency Container* must be created, before the mapping entries can be defined. Press *Create Emergency Container* to start this. An example of a container is shown here:

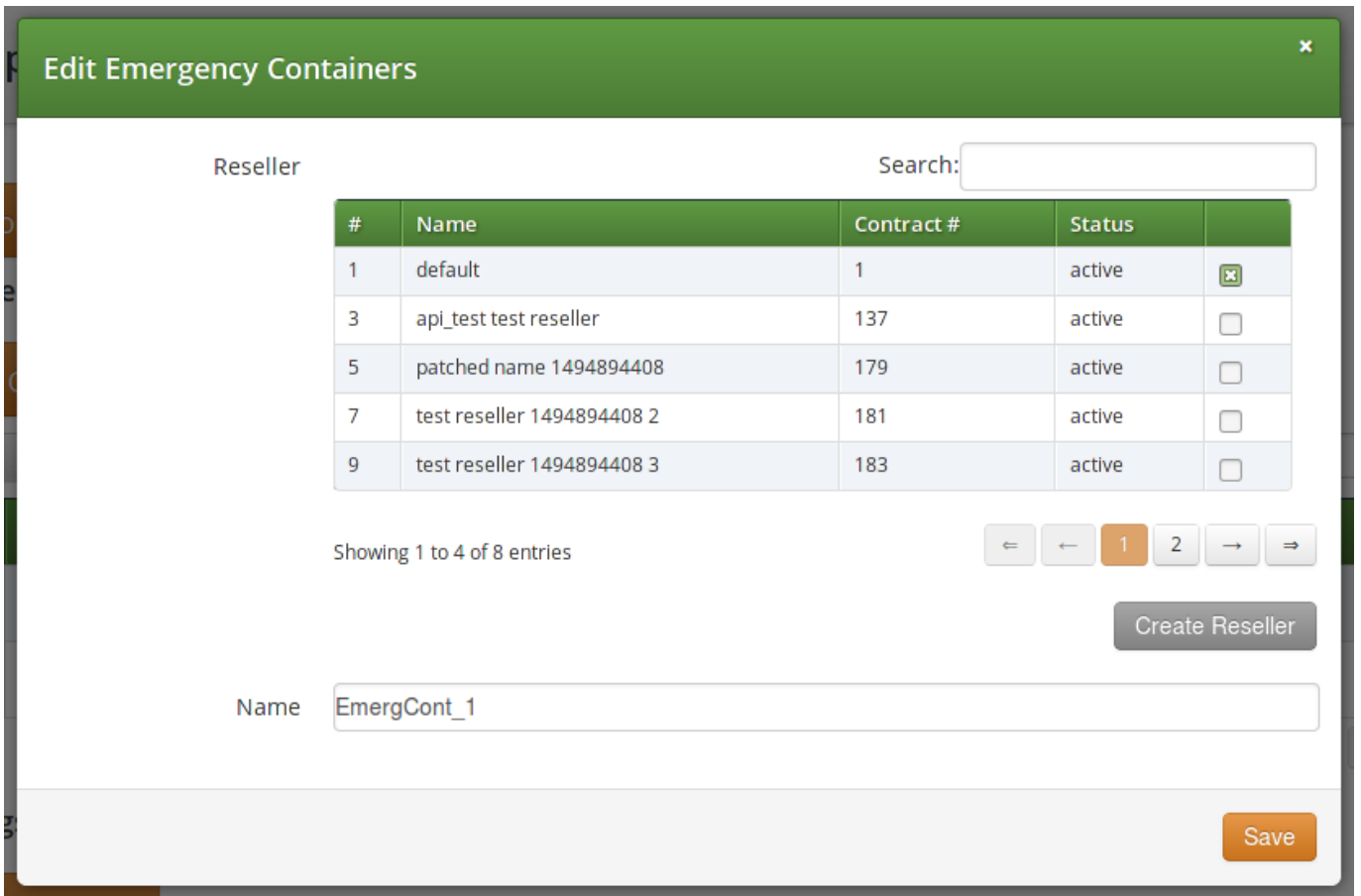

Figure 54: Creating an Emergency Container

You have to select a `Reseller` that this container belongs to, and enter a `Name` for the container, which is an arbitrary text.

Tip

The platform administrator has to create as many containers as the number of different geographic areas (locations) the subscribers are expected to be in.

As the second step of emergency mapping provisioning, the *Emergency Mapping* entries must be created. Press *Create Emergency Mapping* to start this step. An example is shown here:

Emergency Mapping Container

Search:

#	Reseller	Name	
1	default	EmergCont_1	<input checked="" type="checkbox"/>
3	default	EmergCont_2	<input type="checkbox"/>

Showing 1 to 2 of 2 entries

Create Emergency Mapping Container

Code

Prefix

Save

Figure 55: Creating an Emergency Mapping Entry

The following parameters must be set:

- **Container:** select an emergency mapping container (i.e. a location ID)
- **Code:** the emergency number that subscribers will dial
- **Prefix:** the routing prefix that belongs to the particular emergency service within the selected location

Once all the necessary emergency mappings have been defined, the platform administrator will see a list of containers and mapping entries:

Emergency Mappings

← Back
★ Download CSV
★ Upload CSV

Emergency Containers

★ Create Emergency Container

Show 5 entries Search:

#	Reseller	Name
1	default	EmergCont_1
3	default	EmergCont_2

Showing 1 to 2 of 2 entries

Emergency Mappings

★ Create Emergency Mapping

Show 5 entries Search:

#	Container	Reseller	Emergency Number	Emergency Prefix
1	EmergCont_1	default	133	E1_133_
3	EmergCont_1	default	144	E1_144_
5	EmergCont_2	default	133	E2_133_

Figure 56: Emergency Mapping List

The emergency number mapping is now defined. As the next step, the platform administrator has to assign the emergency containers to *Customers / Domains / Customer Locations* or *Subscribers*. We'll take an example with a *Customer*: select the customer, then navigate to *Details → Preferences → Number Manipulations*. In order to assign a container, press the *Edit* button and then select one container from the drop-down list:

Customer #205 - Preferences

← Back Expand Groups

Call Blockings

Access Restrictions

Number Manipulations

Attribute	Name	Value	
emergency_prefix	Emergency Prefix variable		
emergency_suffix	Emergency Suffix variable		
emergency_cli	Emergency CLI		
emergency_mapping_container	Emergency Mapping Container	EmergCont_2	Edit

Internals

Figure 57: Assigning an Emergency Mapping Container

Rewrite Rules for Emergency Mapping

Once emergency containers and emergency mapping entries are defined, Sipwise C5 administrator has to ensure that the proper number manipulation takes place, before initiating any emergency call towards peers.



Important

Please don't forget to define the rewrite rules for peers—particularly: *Outbound Rewrite Rules for Callee*—as described in [Normalize Emergency Calls for Peers](#) section of the handbook.

6.7.2.1 Emergency Calls Not Allowed

There is a special case when the dialed number is recognized as an emergency number, but the emergency number is not available for the geographic area the calling party is located in.

In such a case the emergency mapping lookup will return an emergency prefix, but the value of this will be NULL. Therefore the call is rejected and an announcement is played. The announcement is a newly defined sound file referred as `emergency_geo_unavailable`.

It is possible to configure the rejection code and reason in `/etc/ngcp-config/config.yml` file, the parameters are: `kamailio.proxy.early_rejects.emergency_invalid.announce_code` and `kamailio.proxy.early_reject`

6.7.2.2 Bulk Upload or Download of Emergency Mapping Entries

The Sipwise C5 offers the possibility to upload / download emergency mapping entries in form of CSV files. This operation is available for each reseller, and is very useful if a reseller has many mapping entries.

Downloading Emergency Mapping List

One has to navigate to *Settings* → *Emergency Mapping* menu and then press the *Download CSV* button to get the list of mapping entries in a CSV file. First the reseller must be selected, then the *Download* button must be pressed. As an example, the entries shown in "Emergency Mapping List" picture above would be written in the file like here below:

```
EmergCont_1,133,E1_133_  
EmergCont_1,144,E1_144_  
EmergCont_2,133,E2_133_
```

The **CSV file** has a plain text format, each line representing a mapping entry, and contains the following **fields**:

- Container name, as defined in *Emergency Containers*
- Emergency Number
- Emergency Prefix

Uploading Emergency Mapping List

Uploading a CSV file with emergency mapping entries may be started after pressing the *Upload CSV* button. The following data must be provided:

- *Reseller*: selected from the list
- *Upload mapping*: the CSV file must be selected after pressing the *Choose File* button
- *Purge existing*: an option to purge existing emergency mapping entries that belong to the selected reseller, before populating the new mapping data from the file

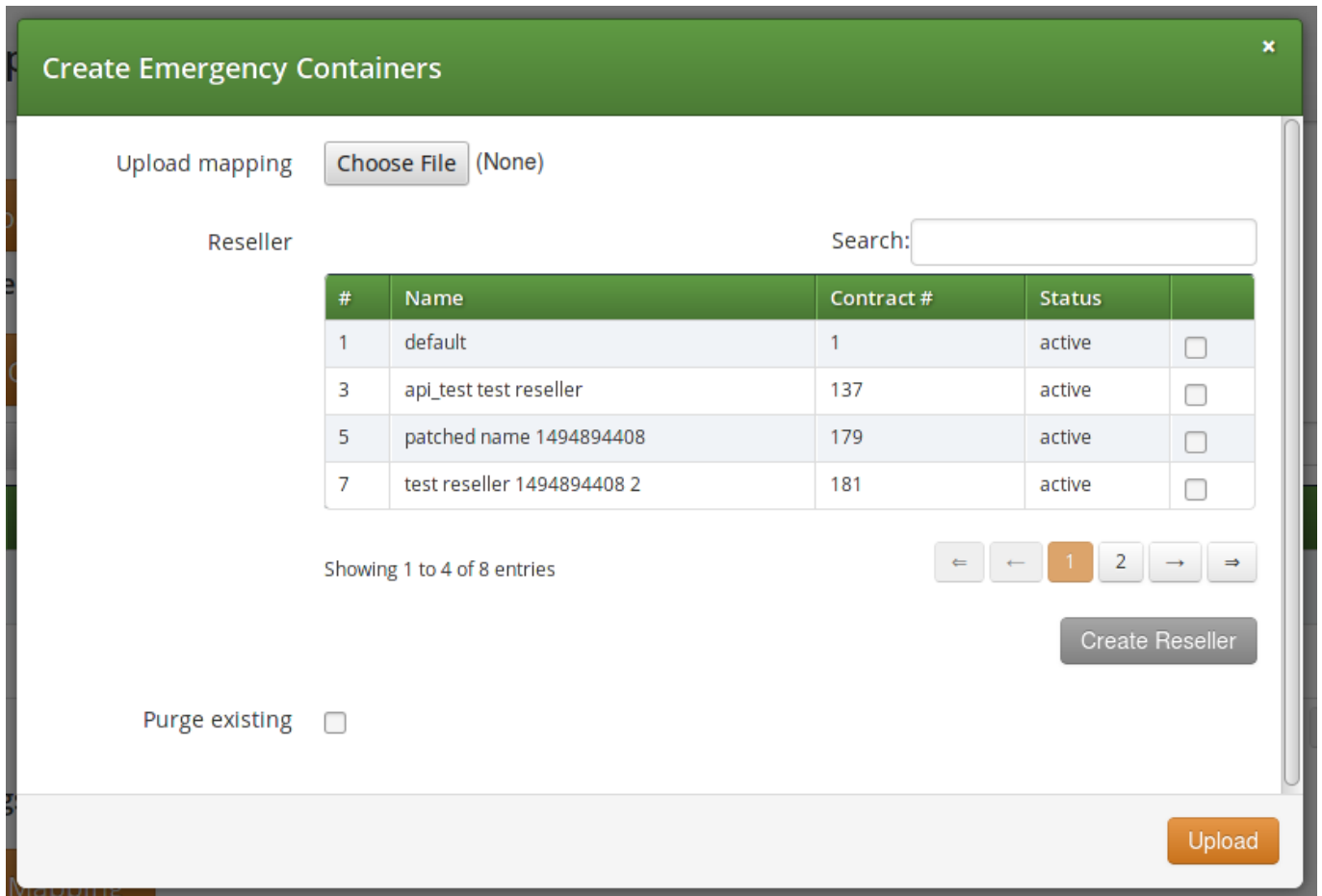

Figure 58: Uploading Emergency Mapping Data

The CSV file for the upload has the same format as the one used for download.

6.8 Emergency Priorization

The Sipwise C5 can potentially host *privileged subscribers* that offer emergency or at least prioritized services (civil defence, police etc.). In case of an emergency, the platform has to be free'd from any SIP flows (calls, registrations, presence events etc.) which do not involve those privileged subscribers.

Such an exceptional condition is called **emergency mode** and it can be activated for all domains on the system, or only for selected domains.

Once emergency mode is activated, Sipwise C5 will immediately apply the following restrictions on new SIP requests or existing calls:

- Any SIP requests (calls, registrations etc.) from subscribers within the affected domains, who are not marked as privileged, are rejected.
- Any calls from peers not targeting privileged subscribers are rejected.

- Any active calls which do not have a privileged subscriber involved are terminated.

Calls from non-privileged subscribers to emergency numbers are still allowed.

6.8.1 Call-Flow with Emergency Mode Enabled

Typical call-flows of emergency mode will be shown in this section of the handbook. We have the following assumptions:

- Emergency prioritization has been enabled on system-level
- There is a domain for which the emergency mode has been activated
- There is a privileged subscriber in that domain
- A generic peering connection has been configured for non-emergency calls
- A dedicated peering connection has been configured for emergency calls

The examples do not show details of SIP messages, but rather give a high-level overview of the call-flows.

1. A **non-privileged** subscriber makes a call **to another non-privileged subscriber**. Result: the call will be **rejected**.

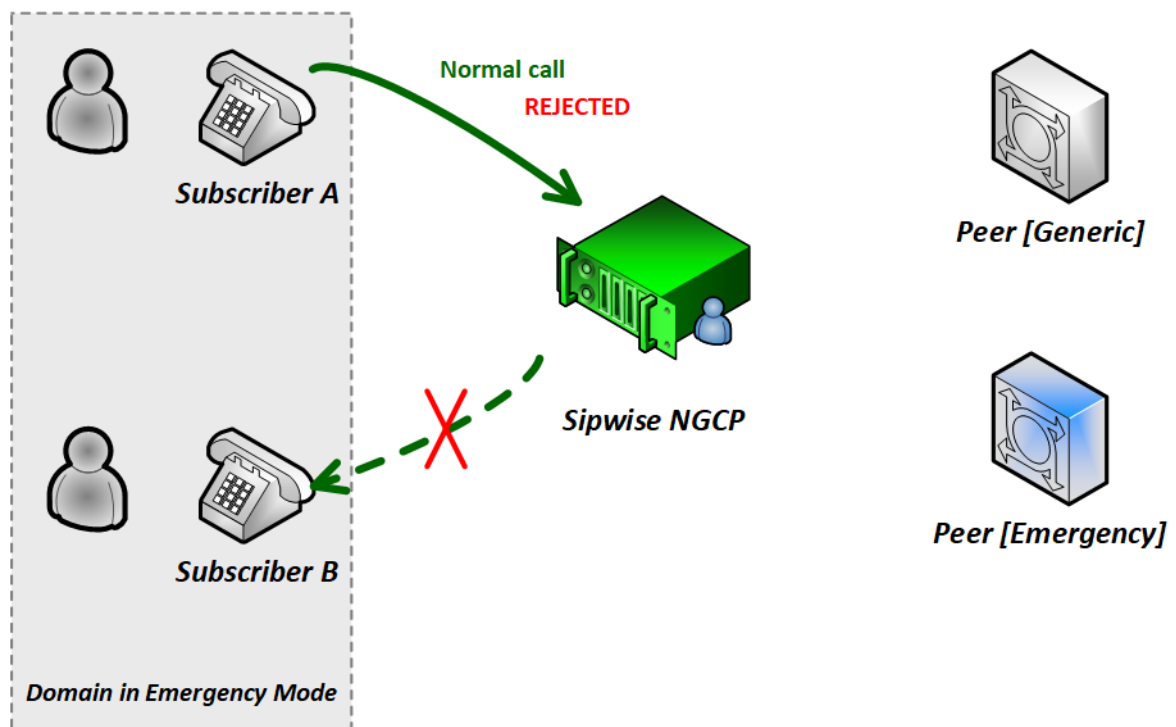

Figure 59: Call-flow in Emergency Mode 1. (Std to Std)

2. A **non-privileged** subscriber makes a call **to an external subscriber (via peer)**. Result: the call will be **rejected**.

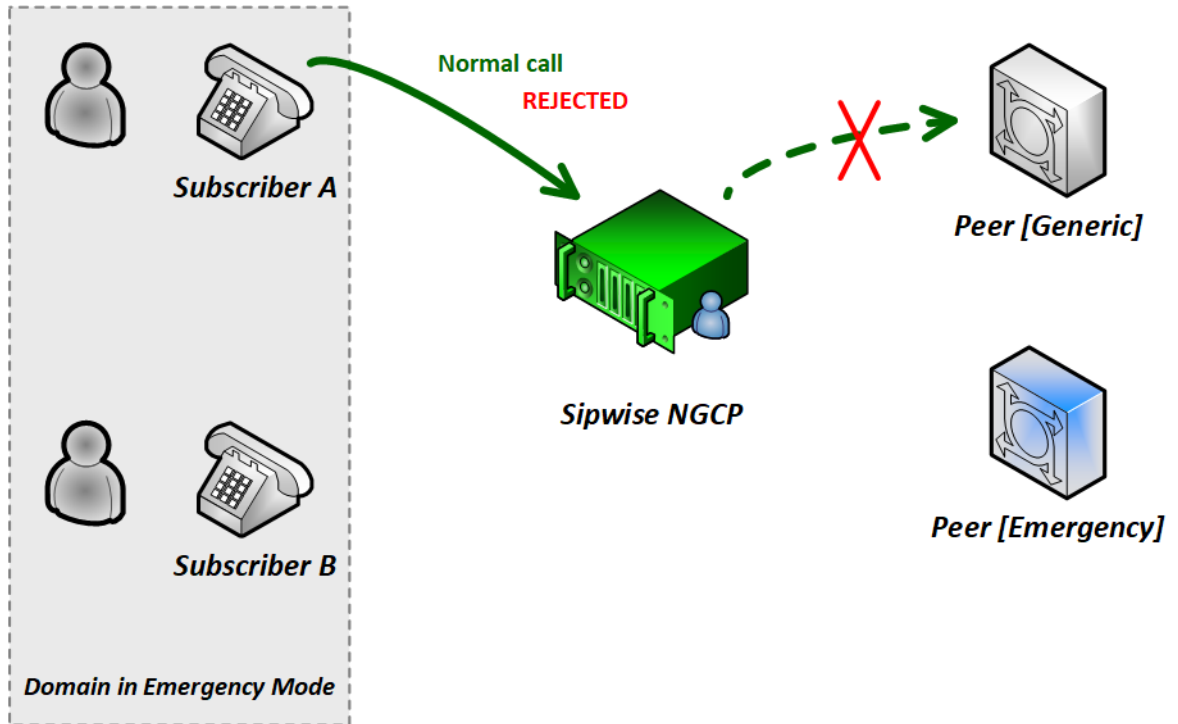

Figure 60: Call-flow in Emergency Mode 2. (Std to Peer)

3. A **non-privileged** subscriber makes a call **to a privileged subscriber**. Result: the call will be **accepted**.

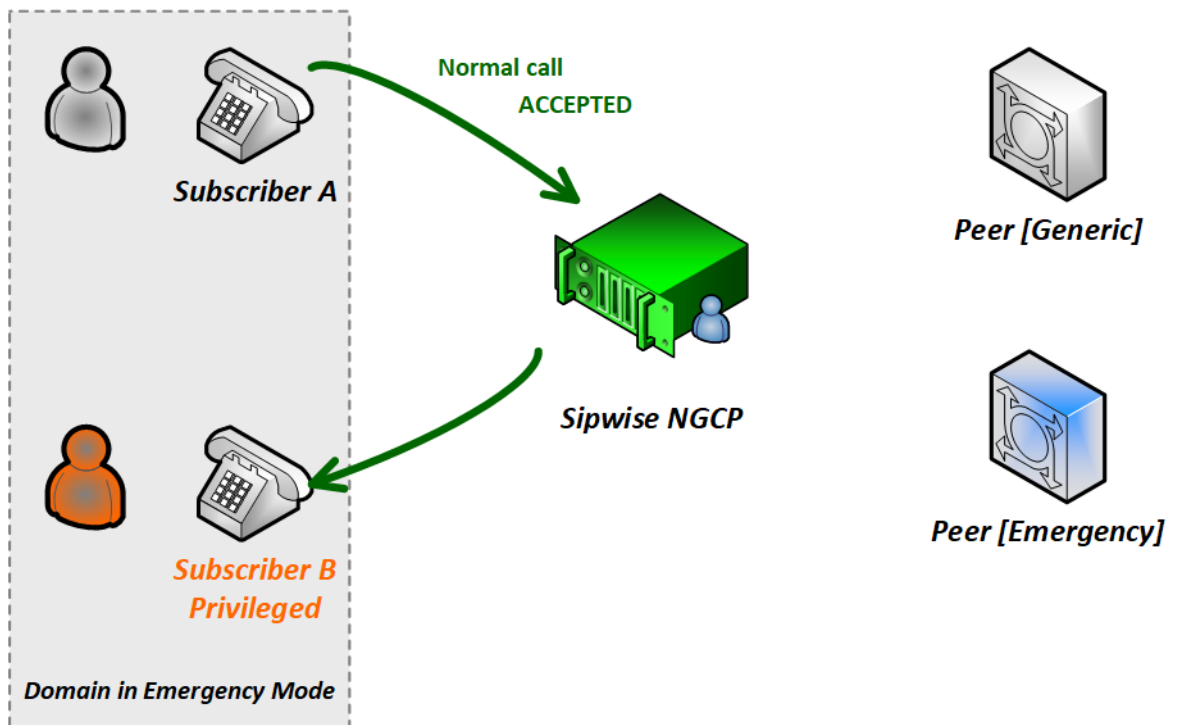

Figure 61: Call-flow in Emergency Mode 3. (Std to Priv)

4. A **non-privileged** subscriber makes a call to an emergency number. Result: the call will be **accepted**.

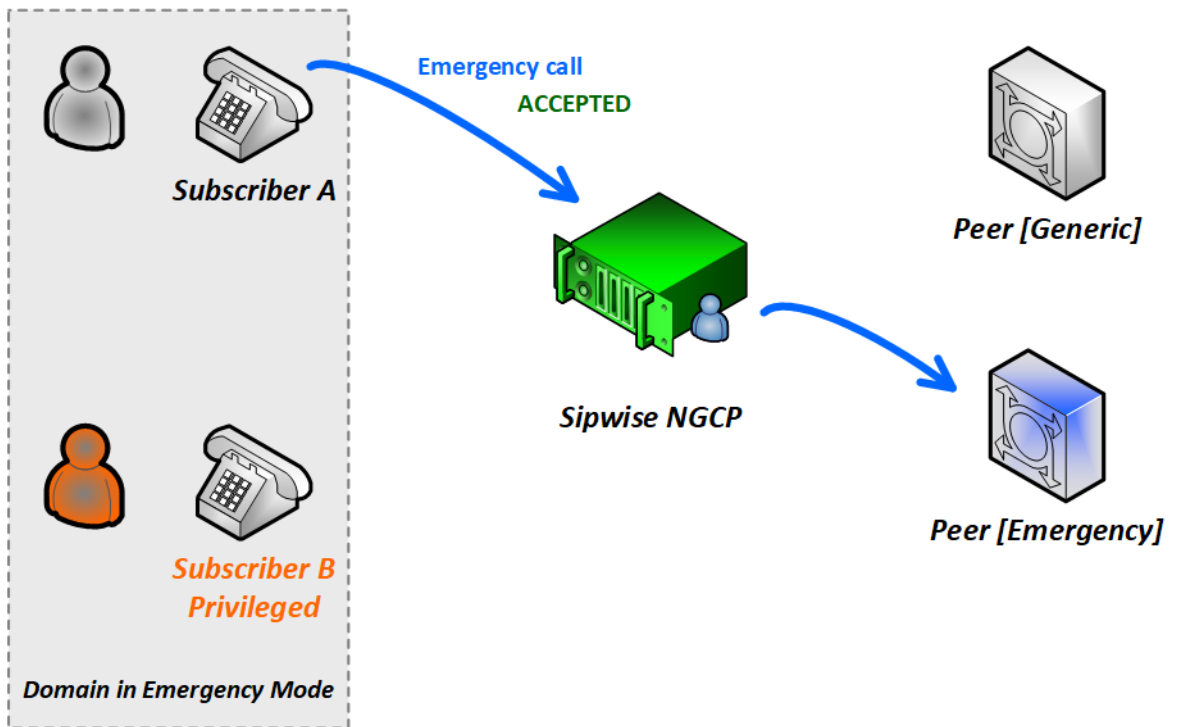

Figure 62: Call-flow in Emergency Mode 4. (Std to Emerg)

5. A **privileged** subscriber makes a call to a non-privileged subscriber. Result: the call will be **accepted**.

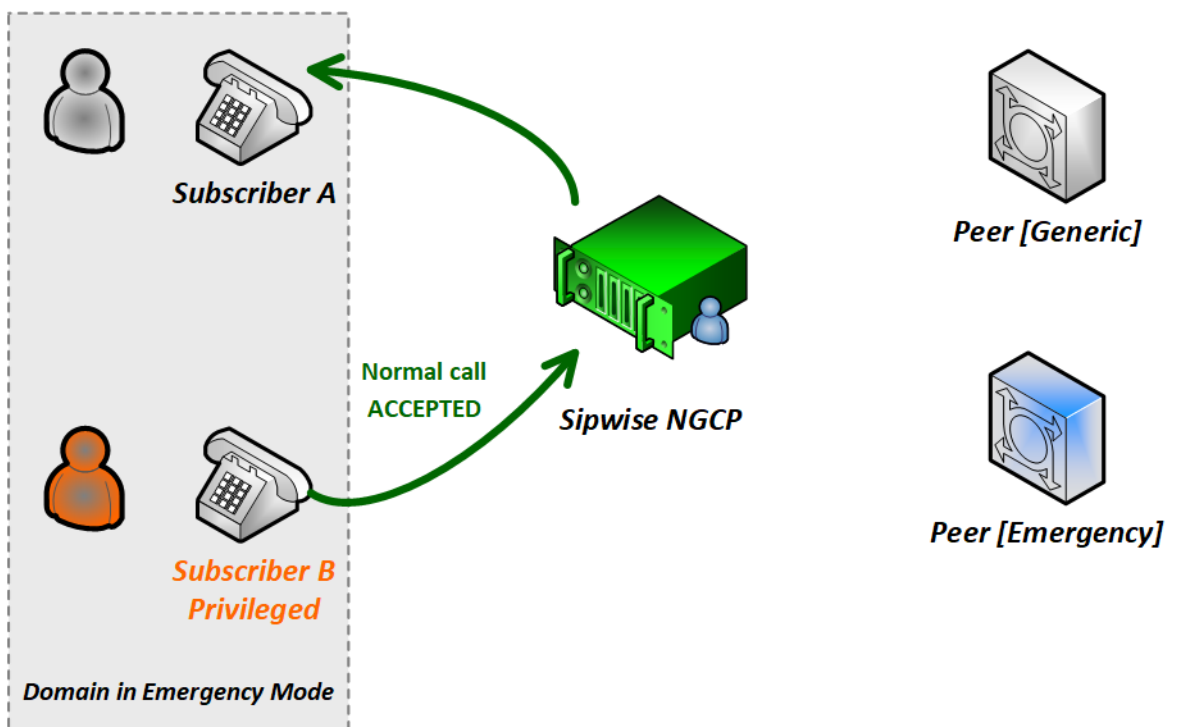

Figure 63: Call-flow in Emergency Mode 5. (Priv to Std)

6. A **privileged** subscriber makes a call **to an external subscriber (via peer)**. Result: the call will be **accepted**.

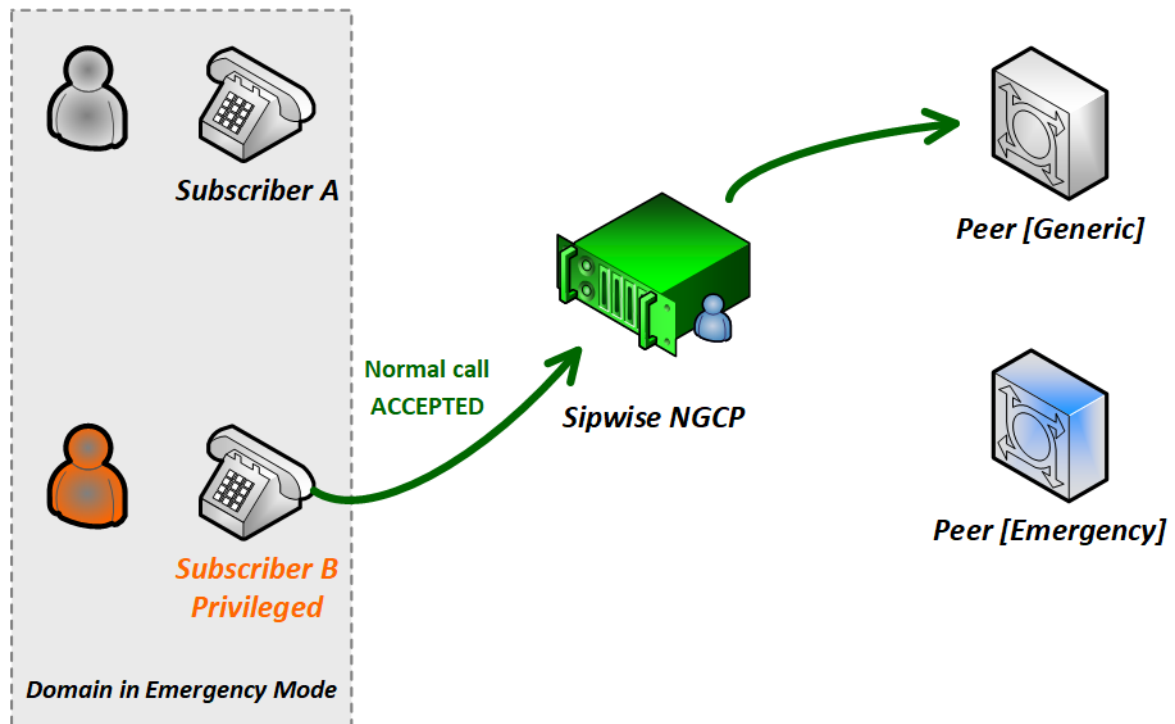

Figure 64: Call-flow in Emergency Mode 6. (Priv To Peer)

6.8.2 Configuration of Emergency Mode

The platform operator has to perform 2 steps of configuration so that the emergency mode can be activated. After the configuration is completed it is necessary to explicitly activate emergency mode, which can be accomplished as described in Section 6.8.3 later.

1. System-level Configuration

The emergency prioritization function must be enabled for the whole system, otherwise emergency mode can not be activated. The platform operator has to set `kamailio.proxy.emergency_priorization.enabled` configuration parameter value to "yes" in the main configuration file `/etc/ngcp-config/config.yml`. Afterwards changes have to be applied in the usual way, with the command: `ngcpcfg apply "Enabled emergency prioritization"`

In order to learn about other parameters related to emergency prioritization please refer to Section B.1.16 part of the handbook.

2. Subscriber-level Configuration

The platform operator (or any administrator user) has the capability to declare a subscriber privileged, so that the subscriber can initiate and receive calls when emergency mode has been activated on the NGCP. In order to do that the administrator has to navigate to *Settings* → *Subscribers* → *select the subscriber* → *Details* → *Preferences* → *Internals* → *emergency_priorization* on the **administrative web interface**, and press the *Edit* button.

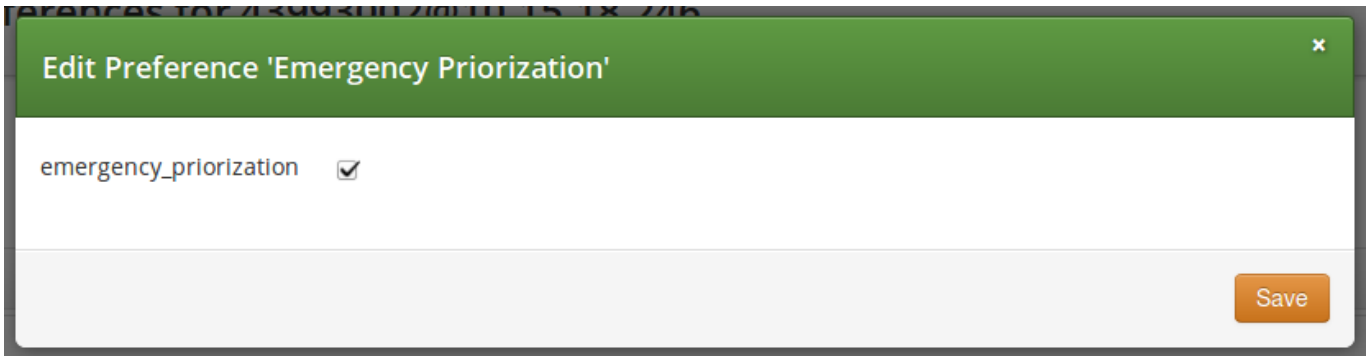

Figure 65: Emergency Priorization of Subscriber

The checkbox `emergency_priorization` has to be ticked and then press the `Save` button.

The same privilege can be added via the **REST API** for a subscriber: a HTTP PUT/PATCH request must be sent on `/api/subscriber` resource and the `emergency_priorization` property must be set to `"true"`.

6.8.3 Activating Emergency Mode

The platform operator can activate emergency mode for a single or multiple domains in 3 different ways:

- via the administrative web interface
- via the REST API
- via a command-line tool



Important

The interruption of ongoing calls is only possible with the command-line tool! Activating emergency mode for domains via the web interface or REST API will only affect upcoming calls.

1. Activate emergency mode via web interface: this way of activation is more appropriate if only a single (or just a few) domain is affected. Please navigate to `Settings` → `Domains` → `select a domain` → `Preferences` → `Internals` → `emergency_mode_enabled` → `Edit`.

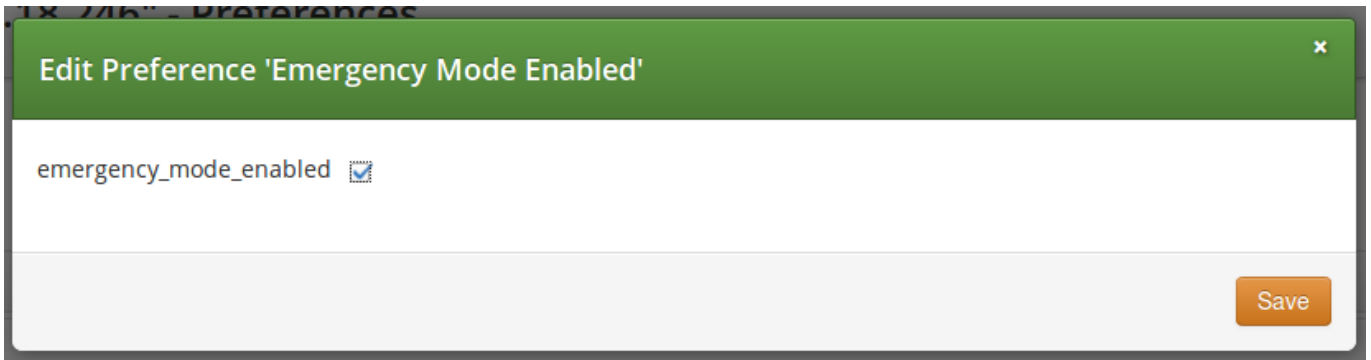

Figure 66: Activate Emergency Mode of Domain

The checkbox `emergency_mode_enabled` has to be ticked and then press the `Save` button.

2. Activate emergency mode via REST API: this way of activation is more appropriate if only a single (or just a few) domain is affected.

For that purpose a HTTP PUT/PATCH request must be sent on `/api/domainpreferences/id` resource and the `emergency_mode_enabled` property must be set to `"true"`.

3. Activate emergency mode using a command-line tool: Sipwise C5 provides a built-in script that may be used to enable/disable emergency mode for some particular or all domains.

- Enable emergency mode:

```
> ngcp-emergency-mode enable <all|[domain1 domain2 ...]>
```

- Disable emergency mode:

```
> ngcp-emergency-mode disable <all|[domain1 domain2 ...]>
```

- Query the status of emergency mode:

```
> ngcp-emergency-mode status <all|[domain1 domain2 ...]>
```

6.9 SIP Message Filtering

6.9.1 Header Filtering

Adding additional SIP headers to the initial INVITEs relayed to the callee (second leg) is possible by creating a [patchtt](#) file for the following template: `/etc/ngcp-config/templates/etc/ngcp-sems/etc/ngcp.sbcprofile.conf.tt2`. The following section can be changed:

```
header_filter=whitelist
header_list=[%IF kamailio.proxy.debug == "yes"%]P-NGCP-CFGTEST, [%END%]
P-R-Uri,P-D-Uri,P-Preferred-Identity,P-Asserted-Identity,Diversion,Privacy,
Allow,Supported,Require,RAck,RSeq,rseq,User-Agent,History-Info,Call-Info
[%IF kamailio.proxy.presence.enable == "yes"%],Event,Expires,
Subscription-State,Accept[%END%] [%IF kamailio.proxy.allow_refer_method
== "yes"%],Referred-By,Refer-To,Replaces[%END%]
```

By default the system will remove from the second leg all the SIP headers which are not in the above list. If you want to keep some additional/custom SIP headers, coming from the first leg, into the second leg you just need to add them at the end of the `header_list=` list. After that, as usual, you need to apply and push the changes. In this way the system will keep your headers in the INVITE sent to the destination subscriber/peer.



Warning

DO NOT TOUCH the list if you don't know what you are doing.

6.9.2 Codec Filtering

Sometimes you may need to filter some audio CODEC from the SDP payload, for example if you want to force your subscribers to do not talk a certain codecs or force them to talk a particular one. To achieve that you just need to change the `/etc/ngcp-config/config.yml`, in the following section:

```
sdp_filter:
  codecs: PCMA,PCMU,telephone-event
  enable: yes
  mode: whitelist
```

In the example above, the system is removing all the audio CODECS from the initial INVITE except G711 alaw,ulaw and telephone-event. In this way the callee will be notified that the caller is able to talk only PCMA. Another example is the `blacklist` mode:

```
sdp_filter:
  codecs: G729,G722
  enable: yes
  mode: blacklist
```

In this way the G729 and G722 will be removed from the SDP payload. In order to apply the changes, run

```
ngcpcfg apply 'Enable CODEC filtering'
```

```
ngcpcfg push all
```

6.9.3 Enable History and Diversion Headers

It may be useful and mandatory - specially with NGN interconnection - to enable SIP History header and/or Diversion header for outbound requests to a peer or even for on-net calls. In order to do so, you should enable the following preferences in Domain's and Peer's Preferences:

- Domain's Preferences: `inbound_uprn` = **Forwarder's NPN**
- Peer's Preferences: `outbound_history_info` = **UPRN**
- Peer's Preferences: `outbound_diversion` = **UPRN**
- Domain's Preferences: `outbound_history_info` = **UPRN** (if you want to allow History Header for on-net call as well)
- Domain's Preferences: `outbound_diversion` = **UPRN** (if you want to allow Diversion Header for on-net call as well)

6.9.4 User Agent Filtering

It could be useful to filter the received REGISTER and INVITE messages based on the User Agent header, for example if you want to force your subscribers to use certain types of devices. To achieve that configuration system wide you just need to change the `/etc/ngcp-config/config.yml`, in the following section:

```
kamailio:
  proxy:
    block_useragents:
      action: reject
      enable: yes
      mode: whitelist
      ua_patterns:
        - Yealink.*
```

In the example above, the system is allowing all the messages which have User Agent header starting with *Yealink*. All the others will be rejected with a *403 Forbidden message*. To silently drop the received message it is possible to specify the *drop* action instead of the default *reject*. Another example is the `blacklist` mode:

```
kamailio:
  proxy:
    block_useragents:
      action: drop
      enable: yes
      mode: blacklist
      ua_patterns:
```

```
- friendly-scanner
```

In this example the system will block all the messages which have User Agent header equal to *friendly-scanner*. Because of the *drop* action this messages will be silently dropped, without providing any feedback to the sender. As usual, in order to apply the changes, run

```
ngcpcfg apply 'Enable User-Agent filtering'  
ngcpcfg push all
```

Regardless of the system-wide configuration (UA filtering enabled or not), it is possible to define a specific User Agent filtering for each Domain or Subscriber. In order to do so, you should configure the following fields in Domain's or Subscriber's Preferences:

- `ua_filter_list`: Contains wildcard list of allowed or denied SIP User-Agents matched against the User-Agent header.
- `ua_filter_mode`: Specifies the operational mode of the SIP User-Agent Filter List: Blacklist or Whitelist.
- `ua_reject_missing`: Rejects any request if no User-Agent header is given.

In case of rejection a message with code `kamailio.proxy.early_rejects.block_admin.announce_code` and reason `kamailio.proxy.early_rejects.block_admin.announce_reason` will be sent back to the subscriber.

6.10 SIP Trunking with SIPconnect

6.10.1 User provisioning

For the purpose of external SIP-PBX interconnect with Sipwise C5 the platform admin should create a subscriber with multiple aliases representing the numbers and number ranges served by the SIP-PBX.

- Subscriber username - any SIP username that forms an "email-style" SIP URI.
- Subscriber Aliases - numbers in the global E.164 format without leading plus.

To configure the Subscriber, go to *Settings*→*Subscribers* and click *Details* on the row of your subscriber. There, click on the *Preferences* button on top.

You should look into the *Number Manipulations* and *Access Restrictions* sections in particular, which control the calling and called number presentation.

6.10.2 Inbound calls routing

Enable preference *Number Manipulations*→*e164_to_ruri* for routing inbound calls to SIP-PBX. This ensures that the Request-URI will comprise a SIP-URI containing the dialed alias-number as user-part, instead of the user-part of the registered AOR (which is normally a static value).

6.10.3 Number manipulations

The following sections describe the recommended configuration for correct call routing and CLI presentation according to the SIPconnect 1.1 recommendation.

6.10.3.1 Rewrite rules

The SIP PBX by default inherits the domain dialplan which usually has rewrite rules applied to normal Class 5 subscribers with inbound rewrite rules normalizing the dialed number to the E.164 standard. If most users of this domain are Class 5 subscribers the dialplan may supply calling number in national format - see Section 5.7. While the SIP-PBX trunk configuration can be sometimes amended it is a good idea in sense of SIPconnect recommendation to send only the global E.164 numbers.

Moreover, in mixed environments with Sipwise C5 Cloud PBX sharing the same domain with SIP trunking (SIP-PBX) customers the subscribers may have different rewrite rules sets assigned to them. The difference is caused by the fact that the dialplan for Cloud PBX is fundamentally different from the dialplan for SIP trunks due to extension dialing, where the Cloud PBX subscribers use the break-out code (see Section 18.1.2) to dial numbers outside of this PBX.

The SIPconnect compliant numbering plan can be accommodated by assigning Rewrite Rules Set to the SIP-PBX subscriber. Below is a sample Rewrite Rule Set for using the global E.164 numbers with plus required for the calling and called number format compliant to the recommendation.

INBOUND REWRITE RULE FOR CALLER

- Match Pattern: `^(00|\+)([1-9][0-9]+)$`
- Replacement Pattern: `\2`
- Description: International to E.164
- Direction: Inbound
- Field: Caller

INBOUND REWRITE RULE FOR CALLEE

- Match Pattern: `^(00|\+)([1-9][0-9]+)$`
- Replacement Pattern: `\2`
- Description: International to E.164
- Direction: Inbound
- Field: Callee

OUTBOUND REWRITE RULE FOR CALLER

- Match Pattern: `^([1-9][0-9]+)$`

- Replacement Pattern: +\1
- Description: For the calls to SIP-PBX add plus to E.164
- Direction: Outbound
- Field: Caller

OUTBOUND REWRITE RULE FOR CALLEE

- Match Pattern: ^ ([1-9] [0-9]+) \$
- Replacement Pattern: +\1
- Description: For the calls to SIP-PBX add plus to E.164
- Direction: Outbound
- Field: Callee

Assign the aforementioned Rewrite Rule Set to the SIP-PBX subscribers.



Warning

Outbound Rewrite Rules for Callee shall NOT be applied to the calls to normal SIP UAs like IP phones since the number with plus does not correspond to their SIP username.

6.10.3.2 User parameter

The following configuration is needed for your platform to populate the From and To headers and Request-URI of the INVITE request with "user=phone" parameter as per RFC 3261 Section 19.1.1 (if the user part of the URI contains telephone number formatted as a telephone-subscriber).

- Domain's Preferences: *outbound_from_user_is_phone* = Y
- Domain's Preferences: *outbound_to_user_is_phone* = Y

6.10.3.3 Forwarding number

The following is our common configuration that covers the calling number presentation in a variety of use-cases, including the incoming calls, on-net calls and Call Forward by the platform:

- Domain's Preferences: *inbound_uprn* = **Forwarder's NPN**
- Domain's Preferences: *outbound_from_user* = **UPRN (if set) or User-Provided Number**
- Domain's Preferences: *outbound_pai_user* = **UPRN (if set) or Network-Provided Number**
- Domain's Preferences: *outbound_history_info* = **UPRN** (if the called user expects History-Info header)

- Domain's Preferences: *outbound_diversion* = **UPRN** (if the called user expects Diversion header)
- Domain's Preferences: *outbound_to_user* = **Original (Forwarding) called user** if the callee expects the number of the subscriber forwarding the call, otherwise leave default.

The above parameters can be tuned to operator specifics as required. You can of course override these settings in the Subscriber Preferences if particular subscribers need special settings.

Tip

On outgoing call from SIP-PBX subscriber the Network-Provided Number (NPN) is set to the *cli* preference prefilled with main E.164 number. In order to have the full alias number as NPN on outgoing call set preference *extension_in_npn* = Y.

Externally forwarded call If the call forward takes place inside the SIP-PBX it can use one of the following specification for signaling the diversion number to the platform:

- using **Diversion** method (RFC 5806): configure Subscriber's Preferences: *inbound_uprn* = **Forwarder's NPN / Received Diversion**
- using **History-Info** method (RFC 7044): Sipwise C5 platform extends the History-Info header received from the PBX by adding another level of indexing according to the specification RFC 7044.

6.10.3.4 Allowed CLIs

- For correct calling number presentation on outgoing calls, you should include the pattern matching all the alias numbers of SIP-PBX or each individual alias number under the *allowed_clis* preference.
- If the signalling calling number (usually taken from From user-part, see *inbound_upn* preferences) does not match the *allowed_clis* pattern, the *user_cli* or *cli* preference (Network-Provided Number) will be used for calling number presentation.

6.10.4 Registration

SIP-PBX can use either Static or Registration Mode. While SIPconnect 1.1 continues to require TLS support at MUST strength, one should note that using TLS for signaling does not require the use of the SIPS URI scheme. SIPS URI scheme is obsolete for this purpose.

Static Mode While SIPconnect 1.1 allows the use of Static mode, this poses additional maintenance overhead on the operator. The administrator should create a static registration for the SIP-PBX: go to Subscribers, *Details*→*Registered Devices*→*Create Permanent Registration* and put address of the SIP-PBX in the following format: sip:username@ipaddress:5060 where username=username portion of SIP URI and ipaddress = IP address of the device.

Registration Mode It is recommended to use the Registration mode with SIP credentials defined for the SIP-PBX subscriber.



Important

The use of RFC 6140 style "bulk number registration" is discouraged. The SIP-PBX should register one AOR with email-style SIP URI. The Sipwise C5 will take care of routing the aliases to the AOR with *e164_to_ruri* preference.

6.10.4.1 Trusted Sources

If a SIP-PBX cannot perform the digest authentication, you can authenticate it by its source IP address in Sipwise C5. To configure the IP-based authentication, go to the subscriber's preferences (*Details*→*Preferences*→*Trusted Sources*) and specify the IP address of the SIP-PBX in the *Source IP* field.

To authenticate multiple subscribers from the same IP address, use the *From* field to distinguish these subscribers.

When this feature is configured for a subscriber, Sipwise C5 authenticates all calls that arrive from the specified IP address without challenging them.



Important

If the same IP address and the FROM field are mistakenly specified as trusted for different subscribers, Sipwise C5 will not know which subscriber to charge for the call and will randomly select one.

6.11 Trusted Subscribers

In some cases, when you have a device that cannot authenticate itself against Sipwise C5, you may need to create a *Trusted Subscriber*. Trusted Subscribers use IP-based authentication and they have a Permanent SIP Registration URI in order to receive messages from Sipwise C5.

In order to make a regular subscriber trusted, perform the following extra steps:

- Create a permanent registration via (*Subscribers*→*Details*→*Registered Devices*→*Create Permanent Registration*)
- Add the IP address of the device as Trusted Source in your subscriber's preferences (*Details*→*Preferences*→*Trusted Sources*).

This way, all SIP messages coming from the device IP will be considered trusted (and get authenticated just by the source IP). All the SIP messages forwarded to the devices will be sent to the SIP URI specified in the subscriber's permanent registration.

6.12 Peer Probing

The basic way of selecting the appropriate peering server, where an outbound call can be routed to, has already been described in Section 5.6.2.3 of the handbook.

This chapter provides information on the *peer probing* feature of Sipwise C5 that is available since the mr5.4.1 release.

6.12.1 Introduction to Peer Probing Feature

The Sipwise C5 provides a web admin panel and API capabilities to configure peering servers in order to terminate calls to non-local subscribers. Those peering servers may become *temporarily unavailable* due to overloading or networking issues. The Sipwise C5 will fail over to another peering server (matching the corresponding peering rules) after a timeout configured at system level (see the `sems.sbc.outbound_timeout` configuration parameter; 6 sec by default), if no provisional response (a response with a code in the range of 100 to 199) is received for the outbound INVITE request.

Even if this timer is set much lower, like 3 sec, the call setup time is increased significantly. This is even more true if multiple peering servers fail at the same time, which will sum up the individual timeouts, finally *causing call setup times reach the order of tens of seconds*.

To optimize the call setup time in such scenarios, a new feature is implemented to *continuously probe peering servers* via SIP messages, and mark them as unavailable on timeout or when receiving unexpected response codes. Appropriate SIP response codes from the peering servers will mark them as available again.

Peering servers *marked as unavailable* are then *skipped during call routing* in the peering selection process, which significantly shortens the call setup times if peering servers fail.

6.12.2 Configuration of Peer Probing

The system administrator has to configure the peer probing feature in 2 steps:

1. System-level configuration enables the peer probing feature in general on the Sipwise C5 and determines the operational parameters, such as timeouts, the SIP method used for probing requests, etc.
2. Peering server configuration will add / remove a peering server to the list of probed endpoints.

6.12.2.1 System-level Configuration

The parameters of peer probing are found in the main system configuration file `/etc/ngcp-config/config.yml`. You can see the complete list of configuration parameters in Section [B.1.16](#) of the handbook, while the most significant ones are discussed here.

Enabling peer probing system-wide happens through the `kamailio.proxy.peer_probe.enable` parameter. If it is set to `yes` (which is the default value) then Sipwise C5 will consider probing of individual peering servers based on their settings.

Timeout of a single probing request can be defined through `kamailio.proxy.peer_probe.timeout` parameter. This is a value interpreted as seconds while Sipwise C5 will wait for a SIP response from the peering server. Default is 5 seconds.

The **probing interval** can be set through the `kamailio.proxy.peer_probe.interval` parameter. This is the time period in seconds that determines how often a probing request is sent to the peering servers. Default is 10 seconds.

The **SIP method** used for probing requests can be defined through `kamailio.proxy.peer_probe.method` parameter. Allowed values are: `OPTIONS` (default) and `INFO`.

Tip

The system administrator, in most of the cases, will not need to modify the default configuration values other than that of timeout and interval.

If no available peering server is found, the call is rejected with the response code and reason configured in `kamailio.proxy.early_rejects` and `kamailio.proxy.early_rejects.peer_unavailable.announce_reason`. If a sound file is configured within the `system_sound_set` assigned to the calling party, an announcement is played as early media before the rejection.

6.12.2.2 Individual Peering Server Configuration

When the peer probing feature is enabled on system-level, it is possible to add each individual peering server to the list of probed endpoints. You can change the probed status of a server in two ways:

Enable probing of a peering server via the admin web interface

1. Open the properties panel of a peering server: *Peerings* → *select a peering group* → *Details* → *select a peering server* → *Edit*
2. Tick the checkbox *Enable Probing*
3. *Save changes*

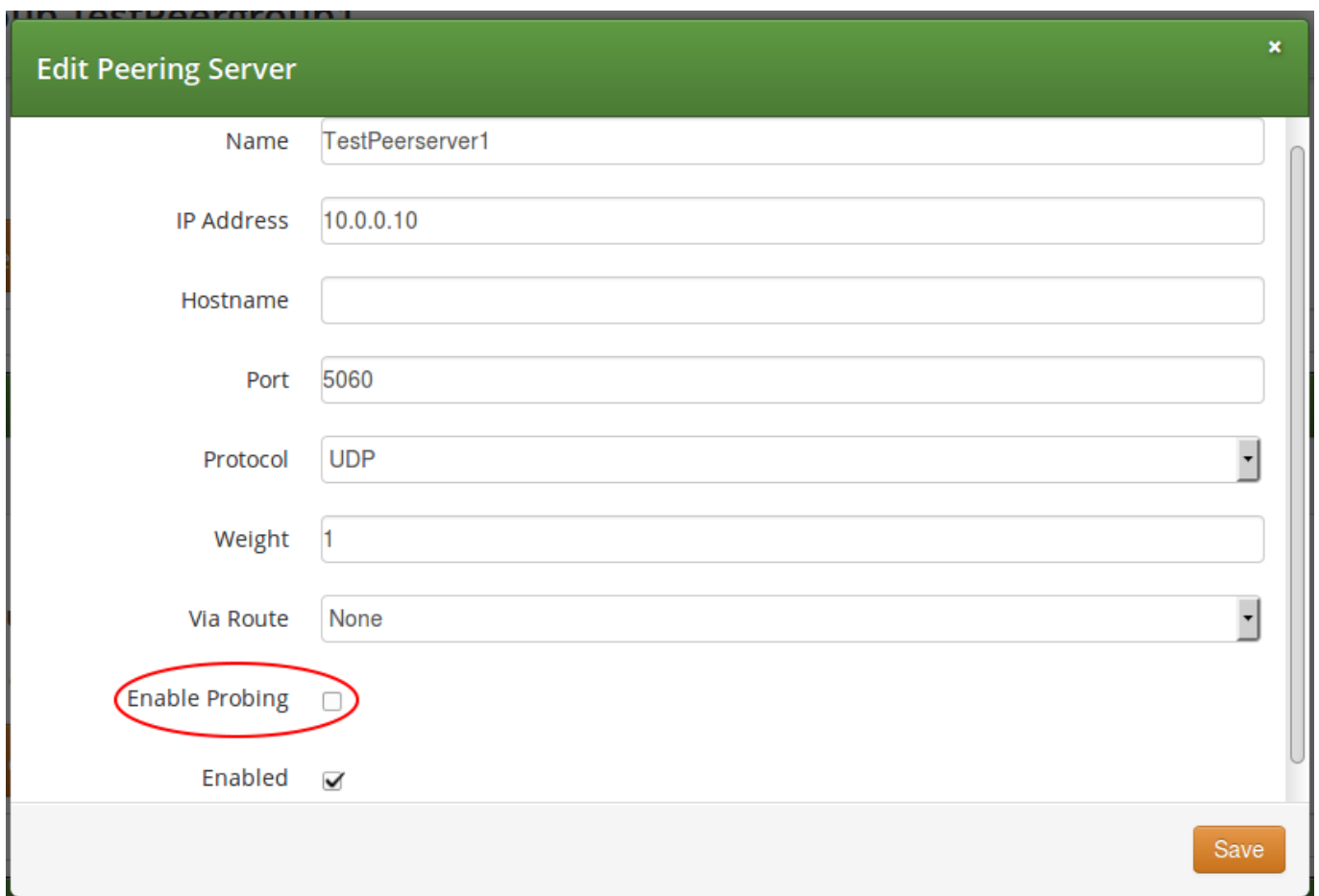

The screenshot shows a modal window titled "Edit Peering Server" with a close button (X) in the top right corner. The form contains the following fields:

- Name: TestPeerserver1
- IP Address: 10.0.0.10
- Hostname: (empty)
- Port: 5060
- Protocol: UDP (dropdown menu)
- Weight: 1
- Via Route: None (dropdown menu)
- Enable Probing: (highlighted with a red circle)
- Enabled:

A "Save" button is located at the bottom right of the form.

Figure 67: Enable Probing of Peering Server

Enable probing of a peering server via the REST API

- when you *create a new peering server* you will use an HTTP *POST* request and the target URL:

https://<IP_of_NGCP>:1443/api/peeringservers

- when you *update an existing peering server* you will use an HTTP *PUT* or *PATCH* request and the target URL:
https://<IP_of_NGCP>:1443/api/peeringservers/id

In all cases you have to set the *probe* property to `true` in order to enable probing, and to `false` in order to disable probing. Default value is `false` and this property may be omitted in a create/update request, which ensures backward compatibility of the `/api/peeringservers` API resource.

6.12.3 Monitoring of Peer Probing

Peering server states, such as "reachable" / "unreachable", are continuously stored in a time-series database (InfluxDB type) by Sipwise C5 Proxy nodes. It is possible to **graphically represent the state of peering servers** on NGCP's admin web interface, just like other system variables (like CPU and memory usage, number of registered subscribers, etc.). However this is not available by default and must be configured by Sipwise.

State changes of peering servers are also reported by means of **SNMP traps**. Each time the reachable state of one of the monitored peering servers changes, Sipwise C5 will send an SNMP trap, raising or clearing the alarm.

The Sipwise MIB is extended by a table of peers per proxy, containing the peer ID and the peer name, along with the peer probe status. An external monitoring system can **poll the peers table via SNMP** to gather the peer status from each proxy's point of view.

The peer information for all nodes is stored in a table rooted at the OID `.1.3.6.1.4.1.34274.1.1.2.40.2.1` with the following OID path:

```
.iso.org.dod.internet.private.enterprises.sipwise.ngcp.ngcpObjects.ngcpMonitor. ←  
  ngcpMonitorPeering.psTable
```

The peer status is an indexed element of that table at the OID `.1.3.6.1.4.1.34274.1.1.2.40.2.1.7` with the following OID path:

```
.iso.org.dod.internet.private.enterprises.sipwise.ngcp.ngcpObjects.ngcpMonitor. ←  
  ngcpMonitorPeering.psTable.psEntry.psPeerStatus
```

Value of *psPeerStatus* can be:

- 0: unknown
- 1: administratively down
- 2: administratively up
- 3: probed, pending
- 4: probed, down
- 5: probed, up

6.12.4 Further Details for Advanced Users

Tip

This subchapter of the handbook is targeted on advanced system operators and Sipwise engineers and is not necessary to read in order to properly manage peer probing feature of NGCP.

6.12.4.1 Behaviour of Kamailio Proxy Instances

Each *kamailio-proxy* instance on the proxy nodes performs the probing individually for performance reasons. Each proxy holds its result in its cache to avoid central storage and replication of the probing results.

Each proxy will send an SNMP trap if it detects a state change for a peering server, because proxies might be geographically distributed along with their load-balancers and can therefore experience different probing results.

Each peering server is cross-checked against the hash table filled during outbound probing requests and is skipped by call routing logic, if a match is found.

On start or restart of the *kamailio-proxy* instance, the probing will start after the first interval, and NOT immediately after start. In the first probing interval the proxy will always try to send call traffic to peering servers until the first probing round is finished, and will only then start to skip unavailable peering servers.

6.12.4.2 Changes to Kamailio Proxy Configuration

A new configuration template: `/etc/ngcp/config/templates/etc/kamailio/proxy/probe.cfg.tt2` is introduced to handle outbound probing requests.

6.12.4.3 Database Changes

A new DB column: `provisioning.voip_peer_hosts.probe` with type TINYINT(1) (boolean) is added to the DB schema.

A peer status change will populate the `kamailio.dispatcher` table, inserting the SIP URI in format `sip:$ip:$port;transport=` in dispatcher group 100, which defines the probing group for peering servers.

Also the `kamailio.dispatcher.attrs` column is populated with a parameter `peerid=$id`. This ID is used during probing to load the peer preferences: `outbound_socket` and `lbrtp_set`, that are required to properly route the probing request.

6.13 Fax Server

There is a Fax Server included in Sipwise C5 . The following sections describe its architecture.

The Fax Server is included on the platform and requires no additional hardware. It supports both T38 and G711 codecs and provides a cost-effective paper-free office solution.

For the details of Fax Server configuration options, please see [Faxserver Configuration](#) chapter in this handbook.

6.13.1 Fax2Mail Architecture

To receive faxes via email, a phone call from a sender is connected to the fax application module (Asterisk + Sipwise C5 Fax Server) on Sipwise C5 . The received fax document is converted to the format the receiver has configured (either PS, PDF or TIFF) via the components outlined in the figure below. The email is delivered to one or more configured addresses.

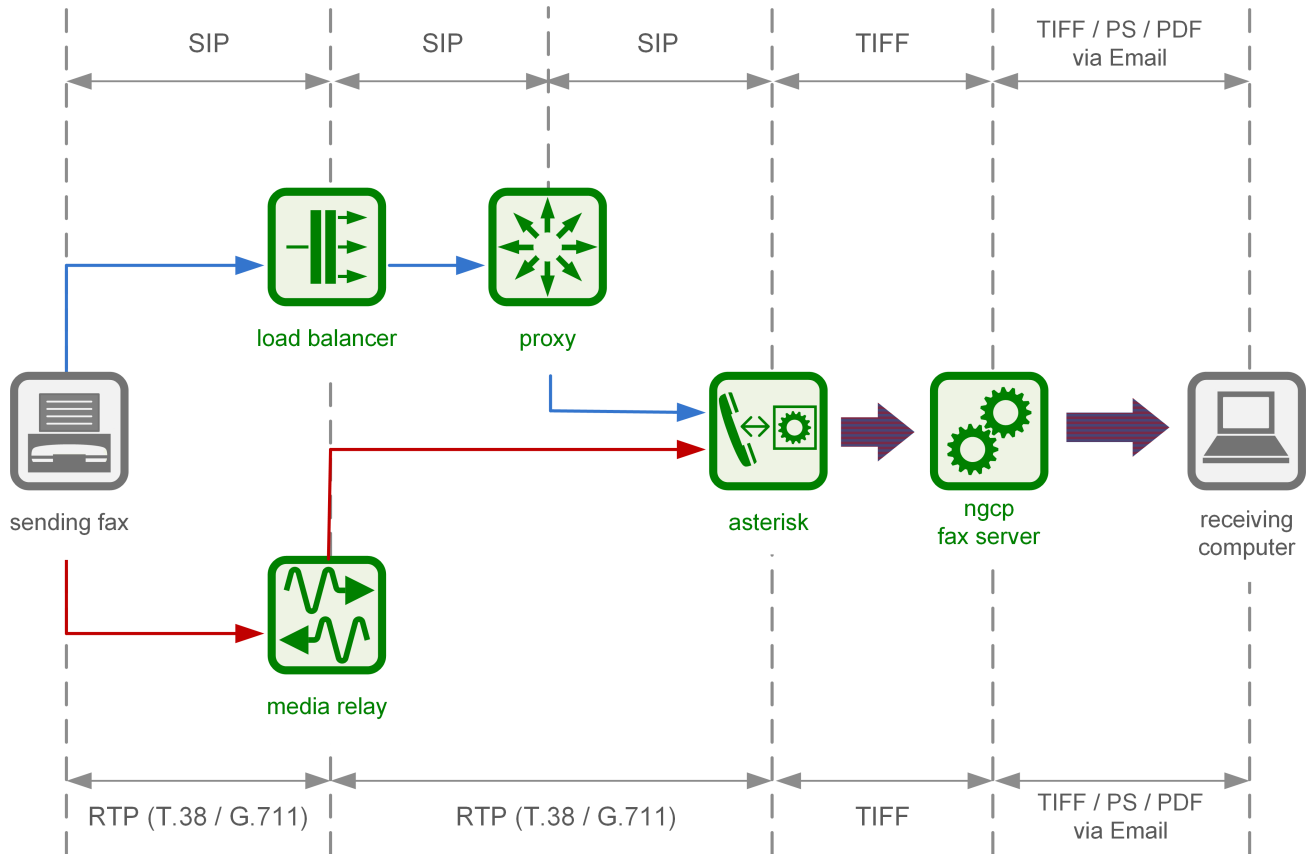

6.13.2 Sendfax and Mail2Fax Architecture

To send faxes via Sipwise C5 a sender can use any email client or an interface such as Webfax or REST API.

Currently, supported formats are TXT, PS, TIFF and PDF.

The document is sent to Sipwise C5 Fax Server instance on Sipwise C5 . Once successfully queued by the fax server, it is converted to an internal TIFF format and is sent via the components outlined in the below figure to the specified phone number. Of course, a fax device that can receive the document must be connected on the destination side.

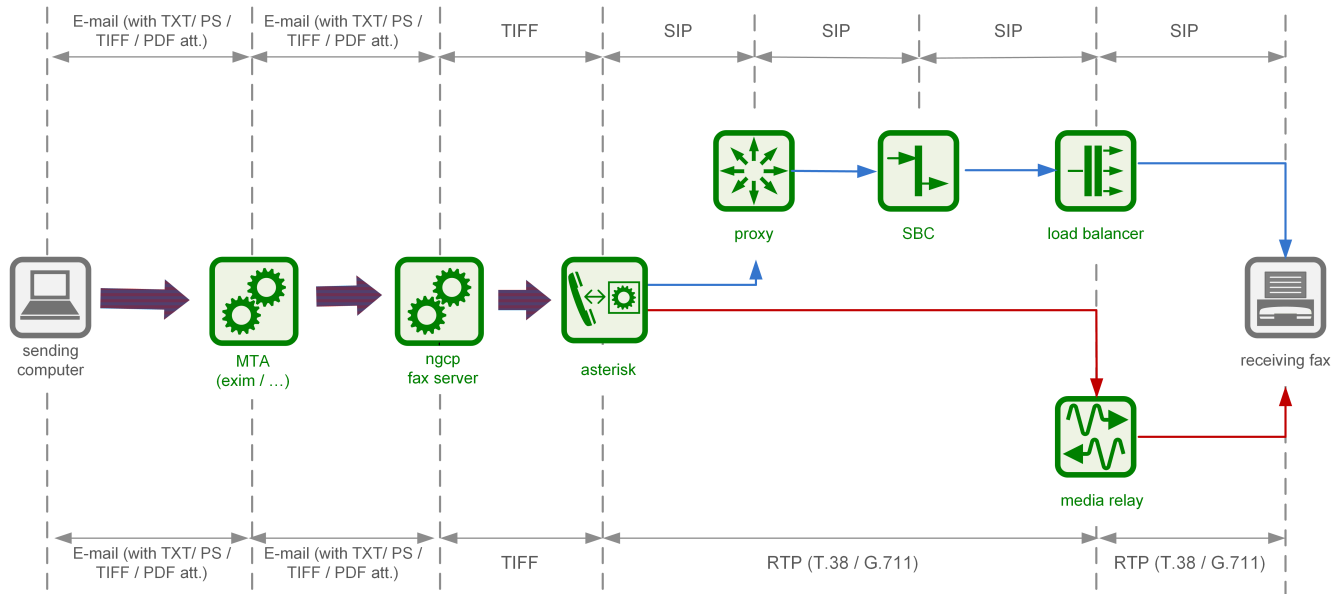

6.14 Voicemail System

6.14.1 Accessing the IVR Menu

For a subscriber to manage his voicebox via IVR, there are two ways to access the voicebox. One is to call the URI `voicebox@yourdomain` from the subscriber itself, allowing password-less access to the IVR, as the authentication is already done on SIP level. The second is to call the URI `voiceboxpass@yourdomain` from any number, causing the system to prompt for a mailbox and the PIN. The PIN can be set in the *Voicemail and Voicebox* section of the *Subscriber Preferences*.

6.14.1.1 Mapping numbers and codes to IVR access

Since access might need to be provided from external networks like PSTN/Mobile, and since certain SIP phones do not support calling alphanumeric numbers to dial `voicebox`, you can map any number to the voicebox URIs using rewrite rules.

To do so, you can provision a match pattern e.g. `^(00|\+)12345$` with a replace pattern `voicebox` or `voiceboxpass` to map a number to either password-less or password-based IVR access respectively. Create a new rewrite rule with the `Inbound` direction and the `Called` field in the corresponding rewrite rule set.

For inbound calls from external networks, assign this rewrite rule set to the corresponding incoming peer. If you also need to map numbers for on-net calls, assign the rewrite rule set to subscribers or the whole SIP domain.

6.14.1.2 External IVR access

When reaching `voiceboxpass`, the subscriber is prompted for her mailbox number and a password. All numbers assigned to a subscriber are valid input (primary number and any alias number). By default, the required format is in E.164, so the subscriber needs to enter the full number including country code, for example `4912345` if she got assigned a German number.

You can globally configure a rewrite rule in `config.yml` using `asterisk.voicemail.normalize_match` and `asterisk.vo`

allowing you to customize the format a subscriber can enter, e.g. having $^0 ([1-9] [0-9]^+)$ \$ as match part and 49\$1 as replace part to accept German national format.

6.14.2 IVR Menu Structure

The following list shows you how the voicebox menu is structured.

- 1 Read voicemail messages
 - 3 Advanced options
 - * 3 To Hear messages Envelope
 - * * Return to the main menu
 - 4 Play previous message
 - 5 Repeat current message
 - 6 Play next message
 - 7 Delete current message
 - 9 Save message in a folder
 - * 0 Save in new Messages
 - * 1 Save in old Messages
 - * 2 Save in Work Messages
 - * 3 Save in Family Messages
 - * 4 Save in Friends Messages
 - * # Return to the main menu
- 2 Change folders
 - 0 Switch to new Messages
 - 1 Switch to old Messages
 - 2 Switch to Work Messages
 - 3 Switch to Family Messages
 - 4 Switch to Friends Messages
 - # Get Back
- 3 Advanced Options
 - * To return to the main menu
- 0 Mailbox options
 - 1 Record your unavailable message
 - * 1 accept it
 - * 2 Listen to it

- * 3 Rerecord it
- 2 Record your busy message
 - * 1 accept it
 - * 2 Listen to it
 - * 3 Rerecord it
- 3 Record your name
 - * 1 accept it
 - * 2 Listen to it
 - * 3 Rerecord it
- 4 Record your temporary greetings
 - * 1 accept it / or re-record if one already exist
 - * 2 Listen to it / or delete if one already exist
 - * 3 Rerecord it
- 5 Change your password
- * To return to the main menu
- * Help
- # Exit

6.14.3 Type Of Messages

A message/greeting is a short message that plays before the caller is allowed to record a message. The message is intended to let the caller know that you are not able to answer their call. It can also be used to convey other information like when you will be available, other methods to contact you, or other options that the caller can use to receive assistance.

The IVR menu has three types of greetings.

6.14.3.1 Unavailable Message

The standard voice mail greeting is the "unavailable" greeting. This is used if you don't answer the phone and so the call is directed to your voice mailbox.

- You can record a custom unavailable greeting.
- If you have not recorded your unavailable greeting but have recorded your name, the system will play a generic message like: "Recorded name is unavailable."
- If you have not recorded your unavailable greeting, the phone system will play a generic message like: "Digits-of-number-dialed is unavailable".

6.14.3.2 Busy Message

If you wish, you can record a custom greeting used when someone calls you and you are currently on the phone. This is called your "Busy" greeting.

- You can record a custom busy greeting.
- If you have not recorded your busy greeting but have recorded your name, the phone system will play a generic message: "Recorded name is busy."
- If you have not recorded your busy greeting and have not recorded your name (see below), the phone system will play a generic message: "Digits-of-number-dialed is busy."

6.14.3.3 Temporary Greeting

You can also record a temporary greeting. If it exists, a temporary greeting will always be played instead of your "busy" or "unavailable" greetings. This could be used, for example, if you are going on vacation or will be out of the office for a while and want to inform people not to expect a return call anytime soon. Using a temporary greeting avoids having to change your normal unavailable greeting when you leave and when you come back.

6.14.4 Folders

The Voicemail system allows you to save and organize your messages into folders. There can be up to ten folders.

6.14.4.1 The Default Folder List

- 0 - New Messages
- 1 - Old Messages
- 2 - Work Messages
- 3 - Family Messages
- 4 - Friends Messages

When a caller leaves a message for you, the system will put the message into the "New Messages" folder. If you listen to the message, but do not delete the message or save the message to a different folder, it will automatically move the message to the "Old Messages" folder. When you first log into your mailbox, the Voicemail System will make the "New Messages" folder the current folder if you have any new messages. If you do not have any new messages it will make the "Old Messages" folder the current folder.

6.14.5 Voicemail Languages Configuration

To add a new language or to change the pronunciation for an existing one, ensure that **mode=new** is defined in `/etc/ngcp-config/templates/etc/asterisk/say.conf.tt2`. Adjust the configuration in the same file using the manual in the beginning. Then, as usual, make the new configuration active.

6.14.6 Flowcharts with Voice Prompts

This section shows flowcharts of calls to the voicemail system. Flowcharts contain the name of prompts as they are identified among *Asterisk* voice prompts.

6.14.6.1 Listening to New Messages

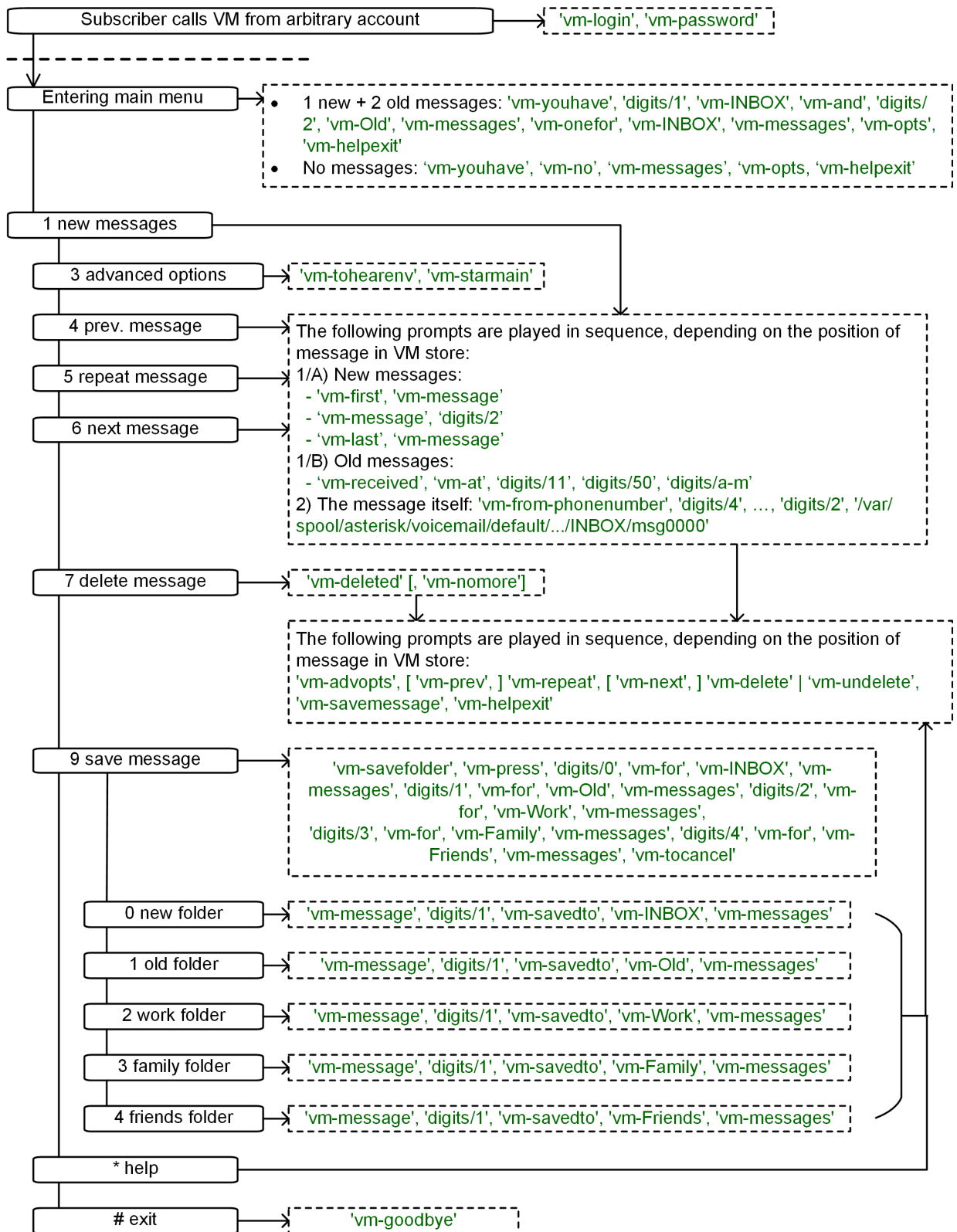

Figure 68: Flowchart of Listening to New Messages

6.14.6.2 Changing Voicemail Folders

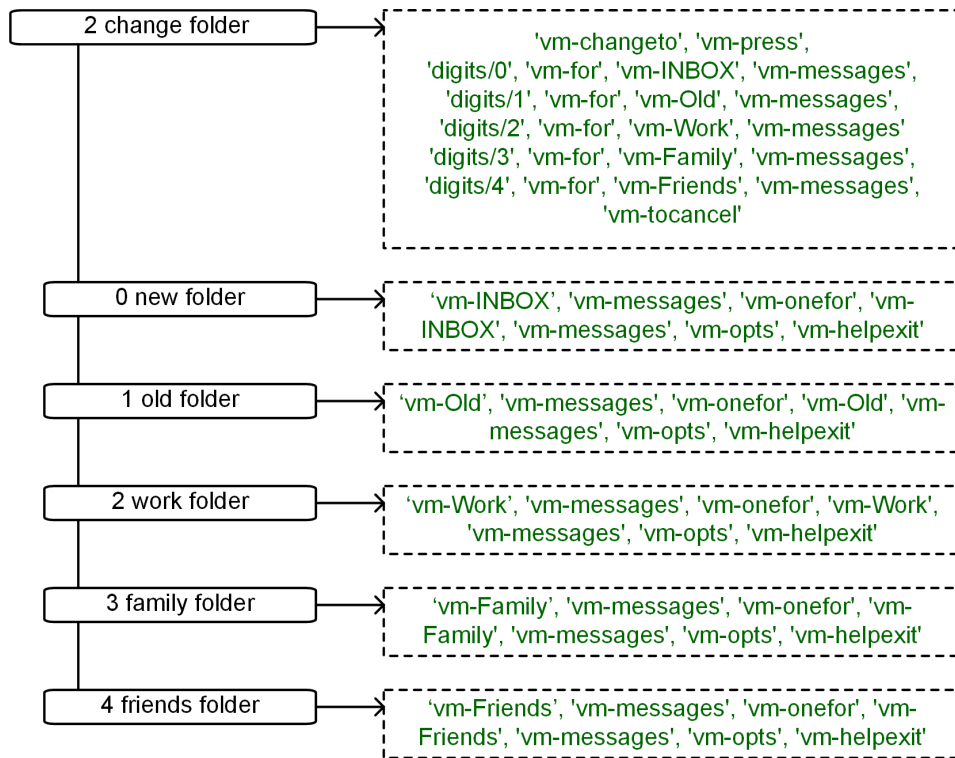

Figure 69: Flowchart of Changing Voicemail Folders

6.14.6.3 Mailbox Options

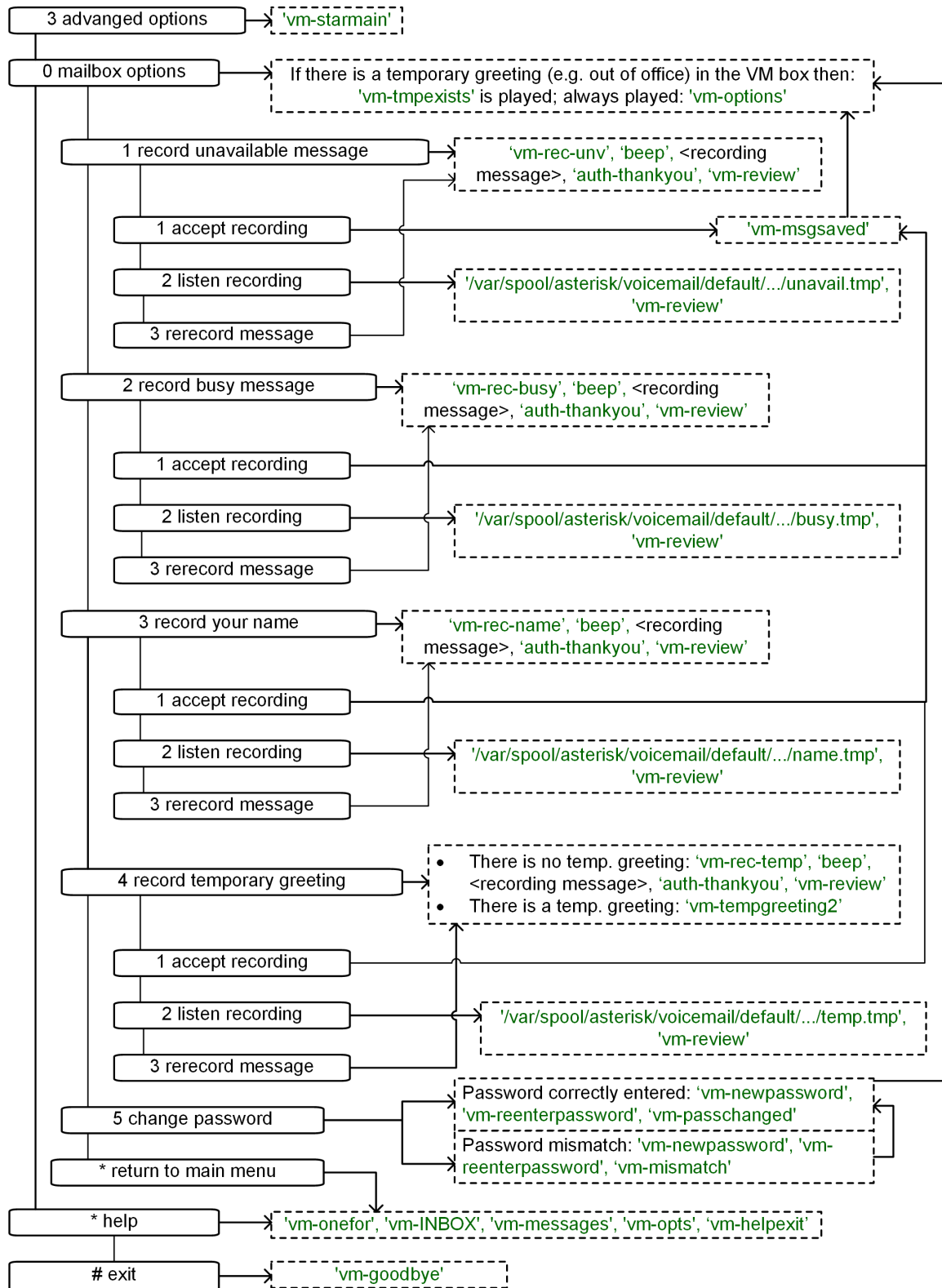

Figure 70: Flowchart of Changing Mailbox Options

6.14.6.4 Leaving a Message

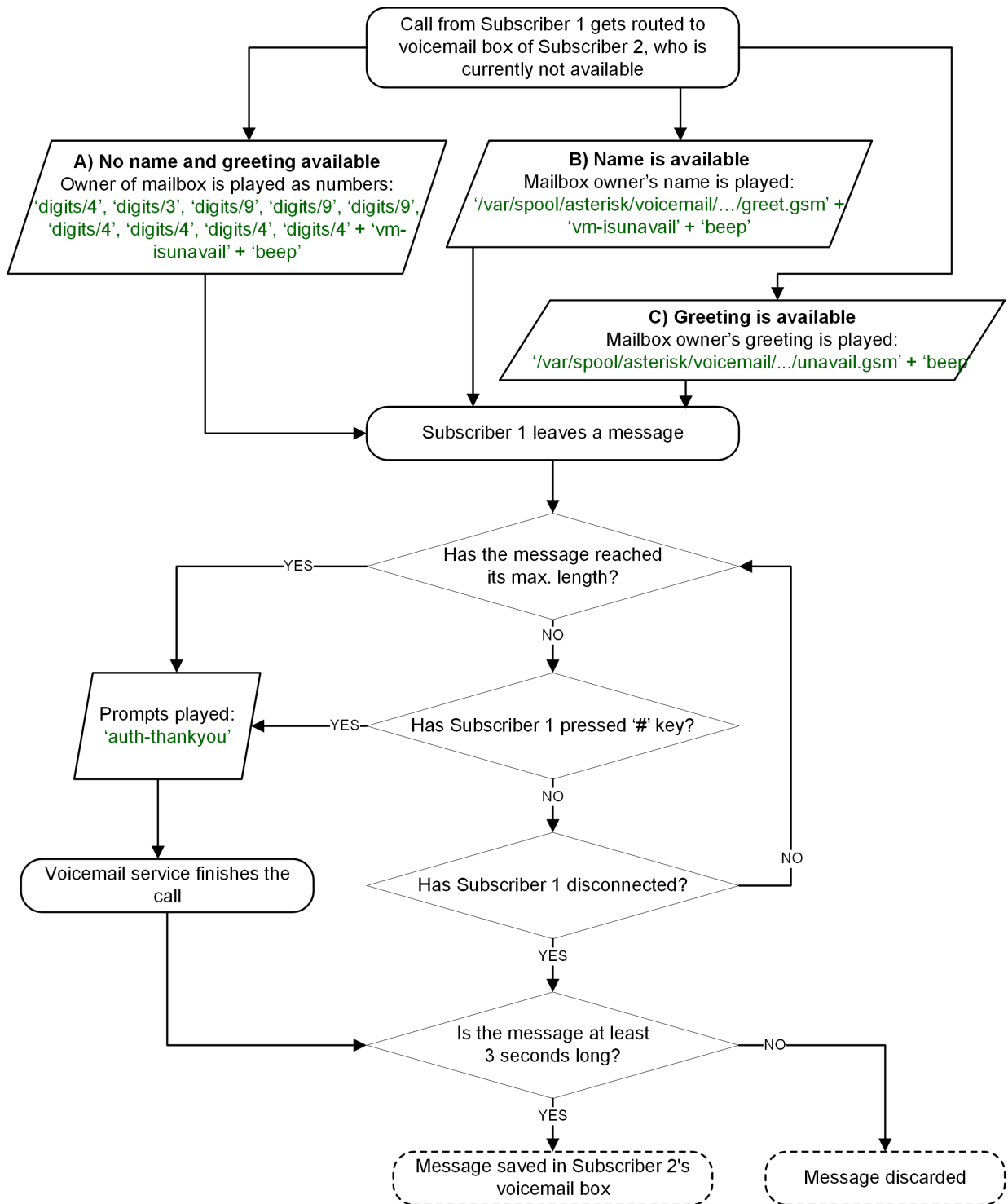
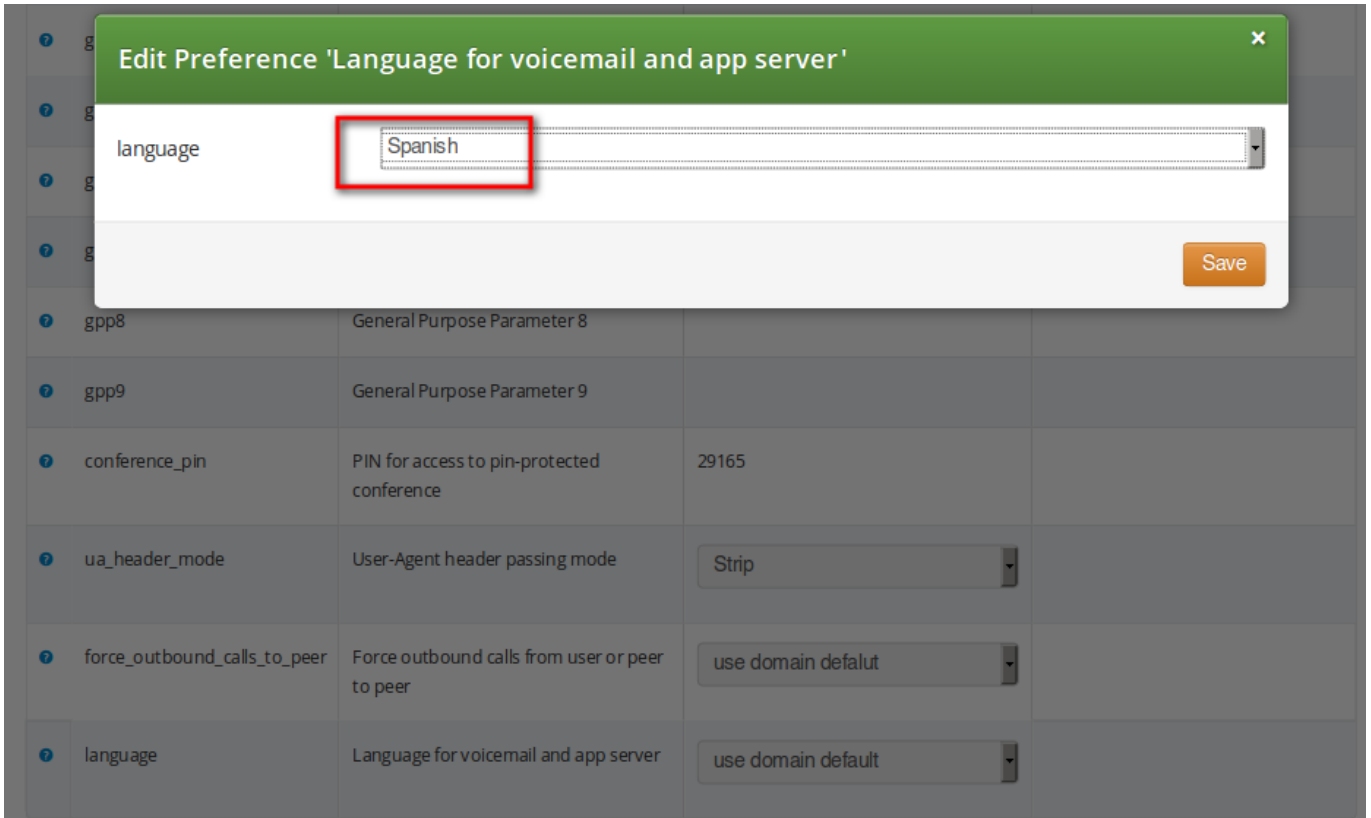

Figure 71: Flowchart of Leaving a Voice Message

6.15 Configuring Subscriber IVR Language

The language for the Voicemail system IVR or Vertical Service Codes (VSC) IVRs may be set using the subscriber or domain preference *language*.



The Sipwise C5 provides the pre-installed prompts for the Voicemail in the English, Spanish, French and Italian languages and the pre-installed prompts for the Vertical Service Codes IVRs in English only.

The other IVRs such as the Conference system and the error announcements use the Sound Sets configured in Sipwise C5 Panel and uploaded by the administrator in his language of choice.

6.16 Sound Sets

The Sipwise C5 provides the administrator with ability to upload the voice prompts such as conference prompts or call error announcements on the *Sound Sets page*. There is a preference *sound_set* in the *NAT and Media Flow Control* section on Domain and Subscriber levels to link subscribers to the sound set that they should hear (as usual the subscriber preference overrides the domain one). Additionally Sound Sets can be configured on Peer level in order to play a dedicated early reject prompt when an incoming call doesn't match any local subscriber. Sound Sets can be defined in *Settings* → *Sound Sets*. To create a new Sound Set, click *Create Sound Set*. Then click the *Files* button.

Logged in as administrator Language Logout

sip:wise NGCP Dashboard Home Monitoring & Statistics Settings

Sound Sets

← Back ★ Create Sound Set

Sound set successfully created

Show 5 entries Search:

#	Reseller	Customer	Name	Description	
1	default		Conference		Edit Delete Files
2	default		Early media rejects	Failed call attempt announcements	

Showing 1 to 2 of 2 entries

Note

You may use 8 or 16 bit mono WAV audio files for all of the voice prompts.

6.16.1 Sound_Set and Contract_Sound_Set Usage

Sound_Set and *Contract_Sound_Set* are used for different purposes:

- *Contract_Sound_Set* is a customer-specific sound set used for the Cloud PBX features. It can be assigned only to a PBX customer.
- *Sound_Set* contains general prompts, e.g. for the Conference, Music on Hold, Early Rejects, etc.

The Music on Hold prompts can be uploaded to both *Contract_Sound_Set* and *Sound_Set*. In this case, the one from the *Sound_Set* will take precedence. Vice versa, digits prompts in *Contract_Sound_Set* will take precedence.

6.16.2 Configuring Early Reject Sound Sets

The call error announcements are grouped under *Early Rejects* section. Unfold the section and click *Upload* next to the sound handles (Names) that you want to use. Choose a WAV file from your file system, and click the Loopplay setting if you want to play the file in a loop instead of just once. Click Save to upload the file.

early_rejects			
Name	Filename	Loop	
block_in		■	
block_out		■	
block_ncos		■	
block_override_pin_wrong		■	
locked_in		■	
locked_out		■	
max_calls_in		■	
max_calls_out		■	
max_calls_peer		■	
unauth_caller_ip		■	

The call error announcements are played to the user in early media hence the name "Early Reject". If you don't provide the sound files for any handles they will not be used and Sipwise C5 will fallback to sending the error response code back to the user.

The exact error status code and text are configurable in the `/etc/ngcp-config/config.yml` file, in `kamailio.proxy.early` section. Please look for the announcement handle listed in below table in order to find it in the configuration file.

Table 4: Early Reject Announcements

Handle	Description	Message played
announce_before_call_setup	This is an announcement that the calling party hears before the call is being actually sent to the destination. The feature can be activated with Applications / <code>play_announce_before_call_setup</code> domain or subscriber preference. Loopplay doesn't have effect on this element.	N/A (custom message, no default)
announce_before_cf	This is an announcement that the calling party hears before the call is being forwarded (Unconditional and Not Available cases) to the destination. The feature can be activated with Applications / <code>play_announce_before_cf</code> domain or subscriber preference.	N/A (custom message, no default)

Table 4: (continued)

Handle	Description	Message played
announce_before_recording	This is an announcement that the calling party hears before the call is actually sent to the destination and before the recording starts. The feature can be activated with Applications / play_announce_before_recording domain or subscriber preference. NAT and Media Flow Control / record_call preference has to be activated as well. Loopplay doesn't have effect on this element.	N/A (custom message, no default)
block_in	This is what the calling party hears when a call is made from a number that is blocked by the incoming block list (<i>adm_block_in_list</i> , <i>block_in_list</i> customer/subscriber preferences)	Your call is blocked by the number you are trying to reach.
block_out	This is what the calling party hears when a call is made to a number that is blocked by the outgoing block list (<i>adm_block_out_list</i> , <i>block_out_list</i> customer/subscriber preferences)	Your call to the number you are trying to reach is blocked.
block_ncos	This is what the calling party hears when a call is made to a number that is blocked by the NCOS level assigned to the subscriber or domain (the NCOS level chosen in <i>ncos</i> and <i>adm_ncos</i> preferences). <i>PLEASE NOTE</i> : It is not possible to configure the status code and text.	Your call to the number you are trying to reach is not permitted.
block_override_pin_wrong	Announcement played to calling party if it used wrong PIN code to override the outgoing user block list or the NCOS level for this call (the PIN set by <i>block_out_override_pin</i> and <i>adm_block_out_override_pin</i> preferences)	The PIN code you have entered is not correct.
callee_busy	Announcement played on incoming call to the subscriber which is currently busy (486 response from the UAS)	The number you are trying to reach is currently busy. Please try again later.
callee_offline	Announcement played on incoming call to the subscriber which is currently not registered	The number you are trying to reach is currently not available. Please try again later.

Table 4: (continued)

Handle	Description	Message played
<code>callee_tmp_unavailable</code>	Announcement played on incoming call to the subscriber which is currently unavailable (408, other 4xx or no response code or 30x with malformed contact)	The number you are trying to reach is currently not available. Please try again later.
<code>callee_unknown</code>	Announcement that is played on call to unknown or invalid number (not associated with any of our subscribers/hunt groups)	The number you are trying to reach is not in use.
<code>cf_loop</code>	Announcement played when the called subscriber has the call forwarding configured to itself	The number you are trying to reach is forwarded to an invalid destination.
<code>emergency_geo_unavailable</code>	Announcement played when emergency destination is dialed but the destination is not provisioned for the location of the user. <i>PLEASE NOTE:</i> The configuration entry for this case in <code>/etc/ngcp-config/config.yml</code> file is <code>emergency_invalid</code> .	The emergency number you have dialed is not available in your region.
<code>emergency_unsupported</code>	Announcement played when emergency destination is dialed but the emergency calls are administratively prohibited for this user or domain (<i>reject_emergency</i> preference is enabled)	You are not allowed to place emergency calls from this line. Please use a different phone.
<code>error_please_try_later</code>	Announcement played when the call is handled by 3rd party call control (PCC) and there was an error during call processing. <i>PLEASE NOTE:</i> This announcement may be configured in the sound set in <code>voucher_recharge</code> section.	An error has occurred. Please try again later.
<code>invalid_speeddial</code>	This is what the calling party hears when it calls an empty speed-dial slot	The speed dial slot you are trying to use is not available.
<code>locked_in</code>	Announcement played on incoming call to a subscriber that is locked for incoming calls	The number you are trying to reach is currently not permitted to receive calls.
<code>locked_out</code>	Announcement played on outgoing call to subscriber that is locked for outgoing calls	You are currently not allowed to place outbound calls.

Table 4: (continued)

Handle	Description	Message played
max_calls_in	Announcement played on incoming call to a subscriber who has exceeded the <i>concurrent_max</i> or <i>concurrent_max_in</i> limit or whose customer has exceeded the <i>concurrent_max_per_account</i> or <i>concurrent_max_in_per_account</i> limit calls	The number you are trying to reach is currently busy. Please try again later.
max_calls_out	Announcement played on outgoing call to a subscriber who has exceeded the <i>concurrent_max</i> (total limit) or <i>concurrent_max_out</i> (limit on number of outbound calls) or whose customer has exceeded the <i>concurrent_max_per_account</i> or <i>concurrent_max_out_per_account</i> limit	All outgoing lines are currently in use. Please try again later.
max_calls_peer	Announcement played on calls from the peering if that peer has reached the maximum number of concurrent calls (configured by admin in <i>concurrent_max</i> preference of peering server). <i>PLEASE NOTE:</i> There is no configuration option of the status code and text in <i>config.yml</i> file for this case.	The network you are trying to reach is currently busy. Please try again later.
no_credit	Announcement played when prepaid account has insufficient balance to make a call to this destination	You don't have sufficient credit balance for the number you are trying to reach.
peering_unavailable	Announcement played in case of outgoing off-net call when there is no peering rule matching this destination and/or source	The network you are trying to reach is not available.
reject_vsc	When the VSC (Vertical Service Code) service is disabled in domain or subscriber preferences (Access Restrictions / <i>reject_vsc</i> is set to TRUE) and a subscriber tries to make a call with VSC, an announcement is played.	N/A (custom message, no default)
relaying_denied	Announcement played on inbound call from trusted IP (e.g. external PBX) with non-local Request-URI domain	The network you are trying to reach is not available.
unauth_caller_ip	This is what the calling party hears when it tries to make a call from unauthorized IP address or network (<i>allowed_ips</i> , <i>man_allowed_ips</i> preferences)	You are not allowed to place calls from your current network location.

Table 4: (continued)

Handle	Description	Message played
voicebox_unavailable	<i>PLEASE NOTE:</i> This announcement is already obsolete, as of Sipwise C5 version mr5.3	The voicemail of the number you are trying to reach is currently not available. Please try again later.

There are some early reject scenarios when either **no voice announcement is played, or a fixed announcement is played**. In either case a SIP error status message is sent from Sipwise C5 to the calling party. It is possible to configure the exact status code and text for such cases in the `/etc/ngcp-config/config.yml` file, in `kamailio.proxy.early_rejects` section. The below table gives an overview of those early reject cases.

Table 5: Additional Early Reject Reason Codes

Handle	Description
block_admin	Caller blocked by <code>adm_block_in_list</code> , <code>adm_block_in_clir</code> and callee blocked by <code>adm_block_out_list</code> (customer or subscriber preference)
block_callee	Callee blocked by subscriber preference <code>block_out_list</code>
block_caller	Caller blocked by subscriber preference <code>block_in_list</code> , <code>block_in_clir</code>
block_contract	Caller blocked by customer preference <code>block_in_list</code> , <code>block_in_clir</code> and callee blocked by customer preference <code>block_out_list</code>
callee_tmp_unavailable_gp	Callee is a PBX group with 0 members. Announcement <code>callee_tmp_unavailable</code> is played; status code and text can be configured.
callee_tmp_unavailable_tm	Callee is a PBX group and we have a timeout (i.e. no group member could be reached). Announcement <code>callee_tmp_unavailable</code> is played; status code and text can be configured.
emergency_invalid	<i>PLEASE NOTE:</i> This handle refers to the same early reject case as <code>emergency_geo_unavailable</code> , but is labeled differently in the configuration file.

6.16.3 Play an announcement on behalf of callee server failure in case of outbound calls

The Sipwise C5 makes it possible to play an announcement on behalf of callee server failure in case of outbound calls. The features can be activated on Subscribers and on Peers. For example: if subscriber A calls subscriber B and B refuses the call with code 404 without providing any announcement, Sipwise C5 can be configured to play a customized announcement to A on behalf of B.

To activate this feature, first create a system *Sound Set*, or use an already existing one, and then assign it to the callee subscriber. Upload in the *Sound Set* one or more announcements. Once the *Sound Set* is configured, the subscriber's preference *announce_error_codes_enable* must be enabled under *Subscriber* → *Preferences* → *NAT and Media Flow Control* menu. Last step is to list in the subscriber's preference *announce_error_codes_list* the announcements that will be played to the caller in case a particular error code is returned back from the callee. Each entry of the list has to be a string composed in the following way: `<error_code>;<announcement_name>`, where *error_code* is the SIP return code and *announcement_name* is name of the announcement taken from the *sound_set* list. Returning to the example above, to play *callee_unknown* message in case of 404 returned from the callee, the entry `404;callee_unknown` has to be added in *announce_error_codes_list* preference.

The same feature is available for peer as well.



Important

In case *announce_error_codes_enable* is enabled, it is important that the remote endpoint doesn't play any announcement for error codes listed in *announce_error_codes_list* otherwise the final result will be to have two announcements: one generated by the remote endpoint and one generated by Sipwise C5.

6.17 Conference System

The Sipwise C5 provides the simple pin-protected conferencing service built using the SEMS DSM scripting language. Hence it is open for all kinds of modifications and extensions.

Template files for the sems conference scripts stored in `/etc/ngcp-config/templates/etc/ngcp-sems/`:

- IVR script: `/etc/ngcp-config/templates/etc/ngcp-sems/dsm/confpin.dsm.tt2`
- Config: `/etc/ngcp-config/templates/etc/ngcp-sems/dsm/confpin.conf.tt2`

6.17.1 Configuring Call Forward to Conference

Go to your *Subscriber Preferences* and click *Edit* on the Call Forward Type you want to set (e.g. *Call Forward Unconditional*).

Destination Voicemail Conference URI/Number

URI/Number

for (seconds)

Advanced View Save

You should select *Conference* option in the *Destination* field and leave the *URI/Number* empty. The timeout defines for how long this destination should be tried to ring.

6.17.2 Configuring Conference Sound Sets

Sound Sets can be defined in *Settings*→*Sound Sets*. To create a new Sound Set, click *Create Sound Set*. Then click the *Files* button.

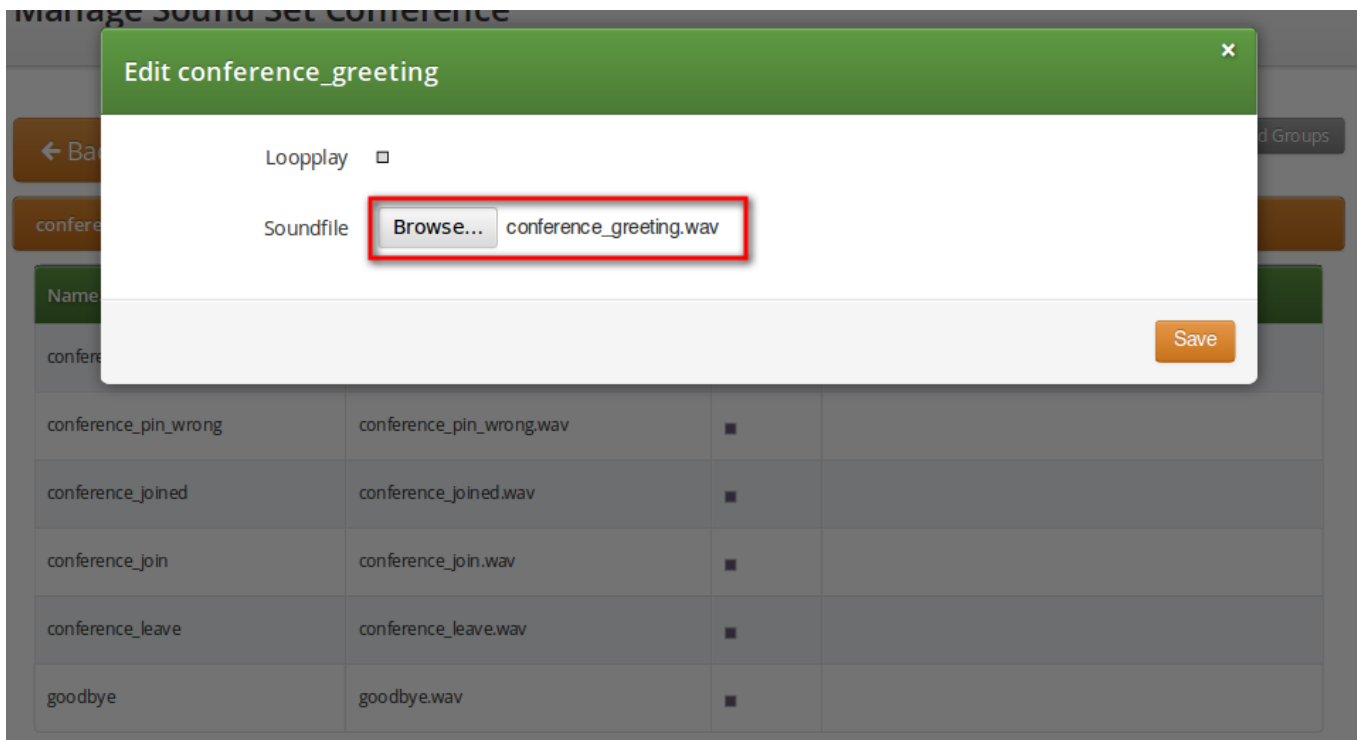

Upload the following files:

Table 6: Conference Sound Sets

Handle	Message played
conference_greeting	Welcome to the conferencing service.
conference_pin	Please enter your PIN, followed by the pound key.
conference_pin_wrong	You have entered an invalid PIN number. Please try again.
conference_joined	You will be placed into the conference.
conference_first	You are the first person in the conference.
conference_join	A person has joined the conference.
conference_leave	A person has left the conference.
conference_max_participants	All conference lines are currently in use. Please try again later.
conference_waiting_music	... waiting music...
goodbye	Goodbye.

Note

You may use 8 or 16 bit mono WAV audio files.

Then set the preference *sound_set* on the Domain or Subscriber level in order to assign the Sound Set you have just created to the subscriber (as usual the subscriber preference overrides the domain one).

6.17.3 Joining the Conference

There are 2 ways of joining a conference: with or without PIN code. The actual way of joining the conference depends on *Subscriber* settings. A subscriber who has activated the conference through call forwarding may set a PIN in order to protect the conference from unauthorized access. To activate the PIN one has to enter a value in *Subscriber* → *Details* → *Preferences* → *Internals* → *conference_pin* field.

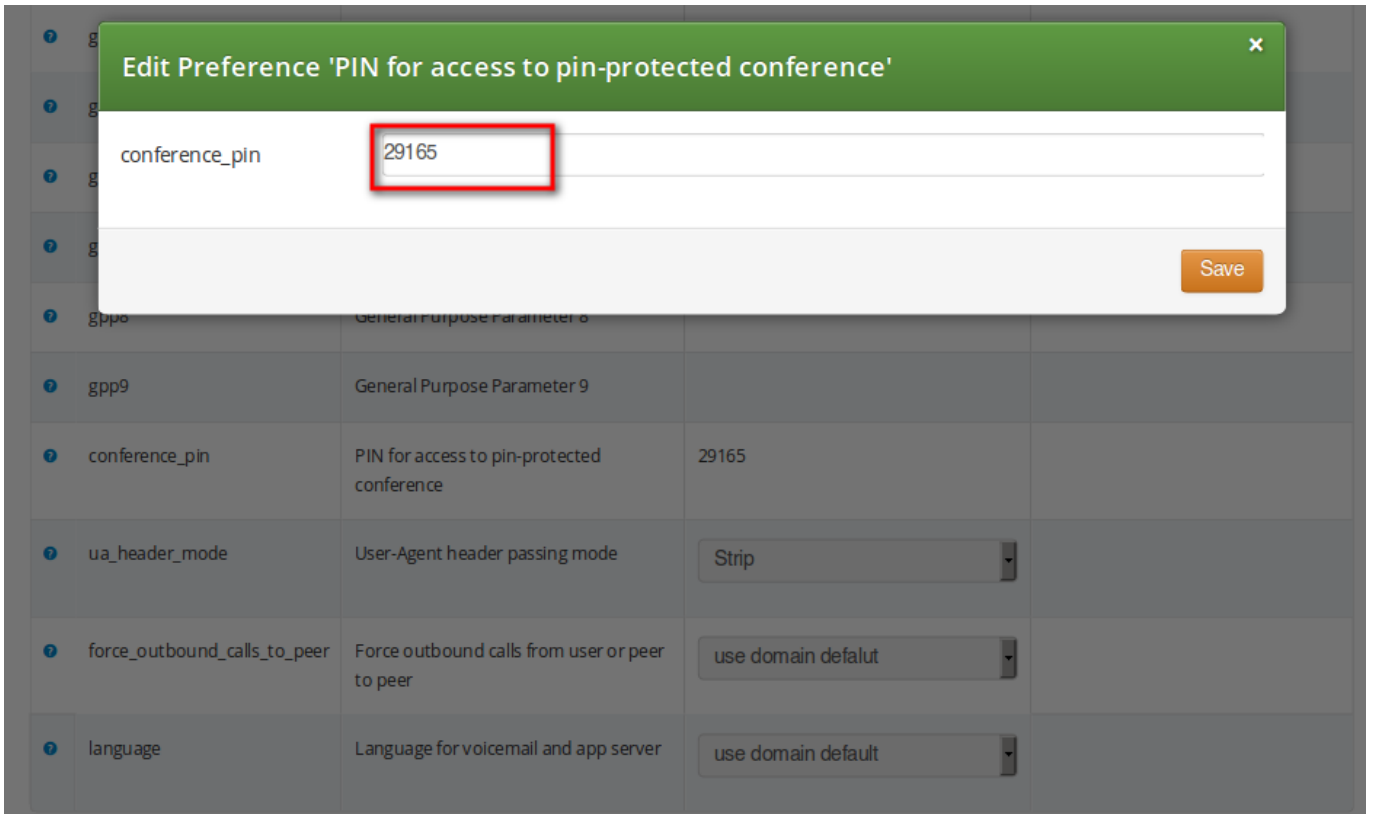

Figure 72: Setting Conference PIN

In case the PIN protection for the conference is activated, when someone calls the subscriber who has enabled the conference, the caller is prompted to enter the PIN of the conference. Upon the successful entry of the PIN the caller hears the announcement that he is going to be placed into the conference and at the same time this is announced to all participants already in the conference.

6.17.4 Conference Flowchart with Voice Prompts

The following 2 sections show flowcharts with voice prompts that are played to a caller when he dials the conference.

6.17.4.1 Conference Flowchart with PIN Validation

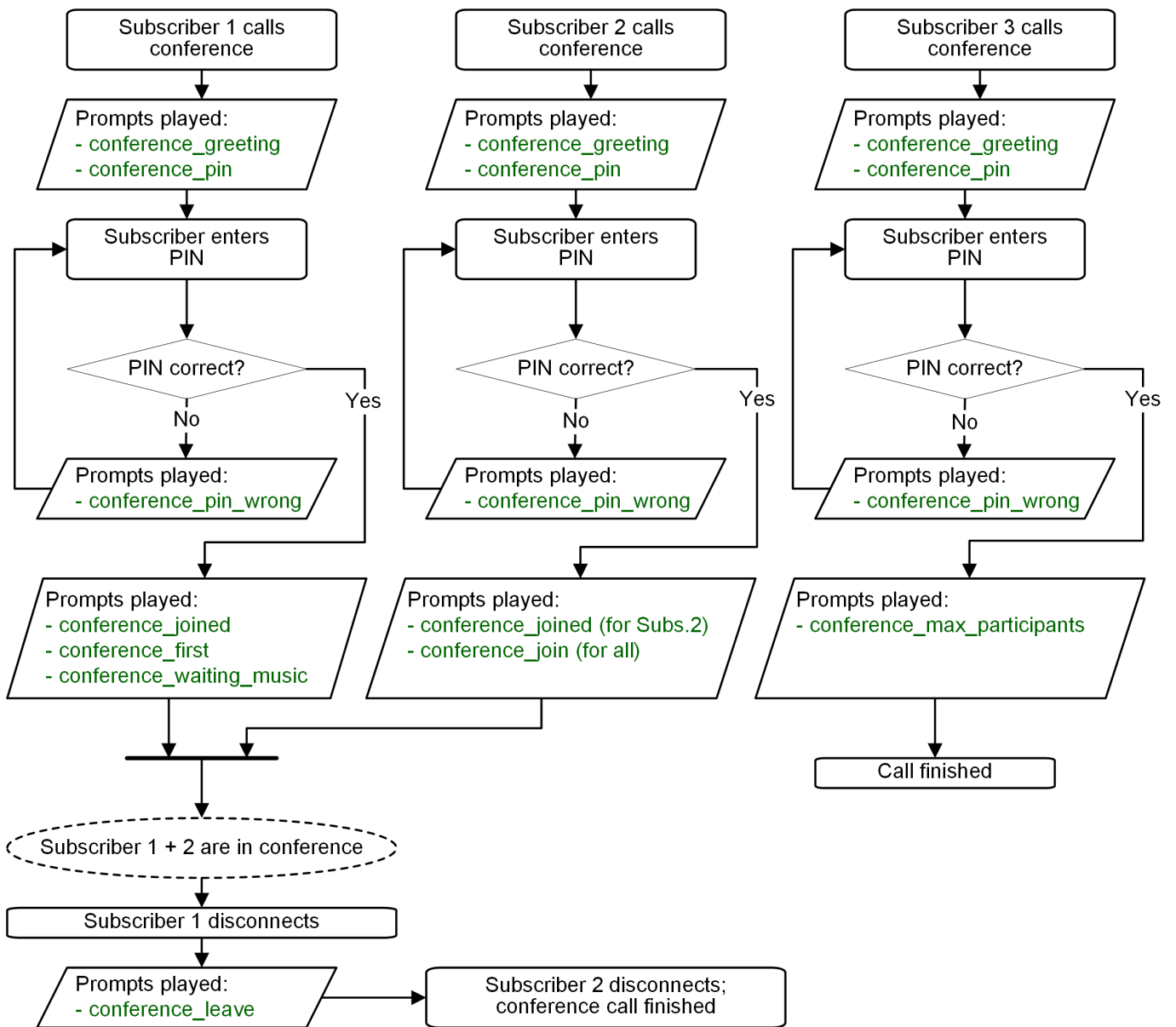

Figure 73: Flowchart of Conference with PIN Validation

6.17.4.2 Conference Flowchart without PIN

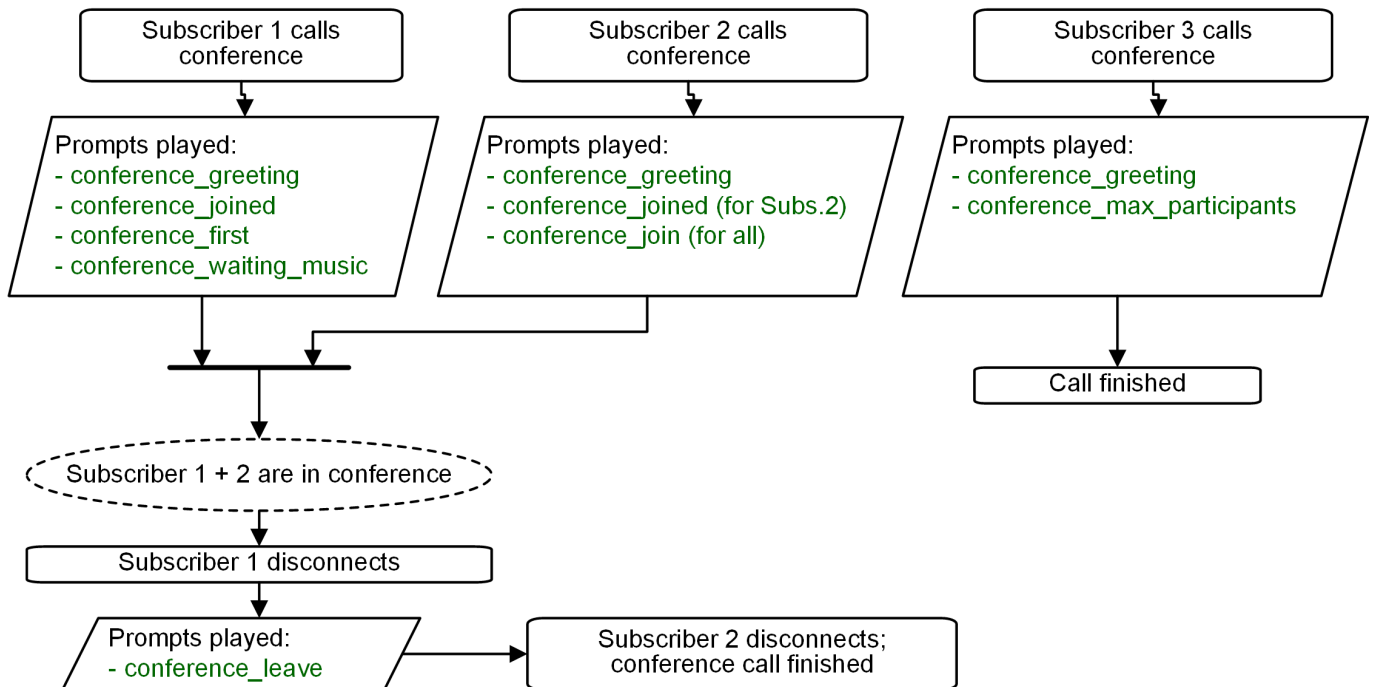

Figure 74: Flowchart of Conference without PIN

6.18 Malicious Call Identification (MCID)

MCID feature allows customers to report unwanted calls to the platform operator.

6.18.1 Setup

To enable the feature first edit `config.yml` and enable there `apps: malicious_call: yes` and `kamailio: store_recent_calls: yes`. The latter option enables kamailio to store recent calls per subscriber UUID in the redis DB (the amount of stored recent calls will not exceed the amount of provisioned subscribers).

Next step is to create a system sound set for the feature. In *Settings* → *Sound Sets* either use your already existing *Sound Set* or create a new *Sound Set* and then assign it to your domain or subscribers. In the *Sound Set* there is a fileset *malicious_call_identification* → for that purpose.

Once the *Sound Set* is created the Subscriber's Preferences *Malicious Call Identification* must be enabled under *Subscriber* → *Preferences* → *Applications* menu. The same parameter can be set in the Customer's preferences to enable this feature for all its subscribers.

The final step is to create a new *Rewrite Rule* and to route calls to, for instance `*123` → MCID application. For that you create a *Callee Inbound* rewrite rule `^(*123)$ → malicious_call`

Finally you run `ngcpcfg apply "Enabling MCID"` to recreate the templates and automatically restart depended services.

6.18.2 Usage

As a subscriber, to report a malicious call you call to either *malicious_call* or to your custom number assigned for that purpose. Please note that you can report only your last received call. You will hear the media reply from the *Sound Set* you have previously configured.

To check reported malicious calls as the platform operator open *Settings*→*Malicious Calls* tab where you will see a list of registered calls. You can selectively delete records from the list and alternatively you can manage the reported calls by using the REST API.

6.19 Subscriber Profiles

The preferences a subscriber can provision by himself via the CSC can be limited via profiles within profile sets assigned to subscribers.

6.19.1 Subscriber Profile Sets

Profile sets define containers for profiles. The idea is to define profile sets with different profiles by the administrator (or the reseller, if he is permitted to do so). Then, a subscriber with administrative privileges can re-assign profiles within his profile sets for the subscribers of his customer account.

Profile Sets can be defined in *Settings*→*Subscriber Profiles*. To create a new Profile Set, click *Create Subscriber Profile Set*.

The screenshot displays the Sipwise NGCP Dashboard interface. At the top, it shows the user is logged in as an administrator, with options for language and logout. The dashboard title is 'sip:wise NGCP Dashboard'. A modal window titled 'Create Subscriber Profile Sets' is open, showing a list of resellers and form fields for creating a new profile set.

Reseller Search:

#	Name	Contract #	Status	
1	default	1	active	<input checked="" type="checkbox"/>
2	test	2	active	<input type="checkbox"/>

Showing 1 to 2 of 2 entries

Navigation:

Name:

Description:

© 2013 Sipwise GmbH, all rights reserved.

You need to provide a reseller, name and description.

To create Profiles within a Profile Set, hover over the Profile Set and click the *Profiles* button.

Profiles within a Profile Set can be created by clicking the *Create Subscriber Profile* button.

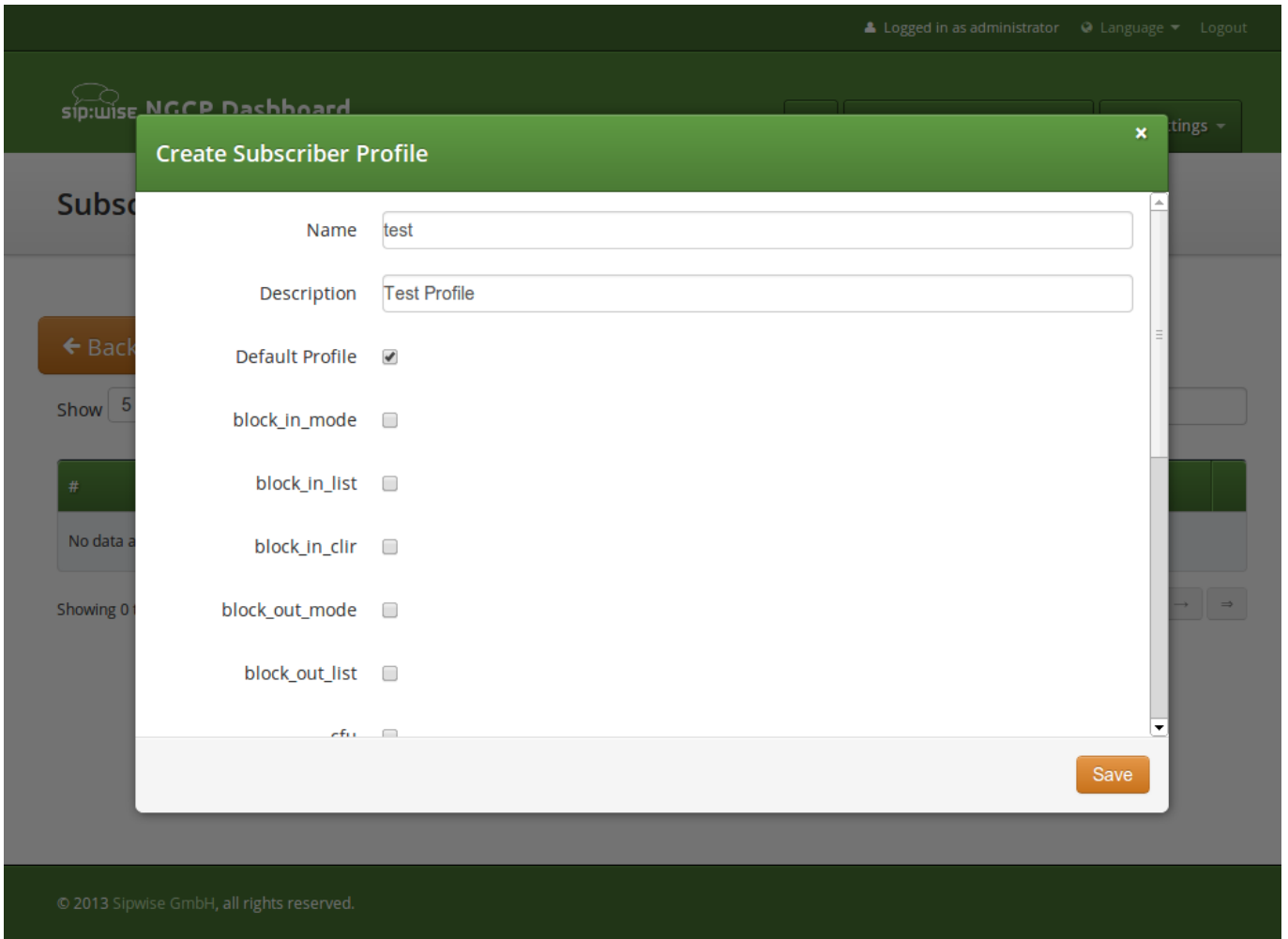

Checking the *Default Profile* option causes this profile to get assigned automatically to all subscribers, who have the profile set assigned. Other options define the user preferences which should be made available to the subscriber.

Note

When the platform administrator selects *Preferences* of the Subscriber Profile he will get an empty page like in the picture below, if none or only certain options are selected in the Subscriber Profile.

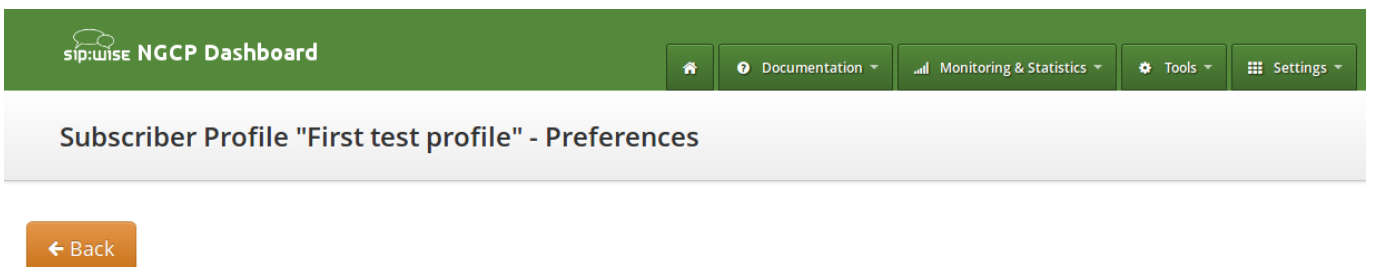

Some of the options, like `ncos` (NCOS level), will enable the definition of that preference within the Subscriber Profile Preferences. Thus all subscribers who have this profile assigned to will have the preference activated by default. The below picture shows the preferences linked to the sample Subscriber Profile:

Attribute	Name	Value
ncos	NCOS Level	Test NCOS for blocking outca

6.20 SIP Loop Detection

In order to detect a SIP loop (incoming call as a response for a call request) Sipwise C5 checks the combination of *SIP-URI*, *To* and *From* headers.

This check can be enabled in `config.yml` by setting `kamailio.proxy.loop_detection.enable: yes`. The system tolerates `kamailio.proxy.loop_detection.expire` seconds. Higher occurrence of loops will be reported with a SIP 482 "Loop Detected" error message

6.21 Call-Through Application

Call-through allows telephony client to dial into an IVR system and specify (in two-stage dialing fashion) a new destination number which is then dialed by Sipwise C5 to connect the client to the destination. As the call-through system needs to be protected from unauthorized use, a list of CLIs which are allowed to use the call-through system is stored in Sipwise C5 platform.

Table 7: Call-Through Mappings

Column	Description
uuid	The internal UUID of the call-through subscriber
auth_key	Authentication key (CLI)
source_uuid	The internal UUID of the subscriber that is authorized for outgoing call leg (same as uuid in call-through scenario)

6.21.1 Activation

The service is installed on every Sipwise C5 system, but is not activated by default. In order to activate the service set the value `1` to the `callthru_features` option under the `www_admin` section of the `config.yml` configuration file, then execute:

```
ngcpcfg set /etc/ngcp-config/config.yml www_admin.callthru_features='1'
ngcpcfg apply 'Enabled call-through'
ngcpcfg push all
```

6.21.2 Administrative Configuration

6.21.2.1 Subscriber provisioning

In order to manage the call-through CLIs for subscriber, navigate to *Settings*→*Subscribers*, search for the subscriber you want to edit, press *Details* and then *Preferences*, scroll down to the *Callthrough CLIs* section and press *Edit Callthrough CLIs* button.

Logged in as administrator

sip:wise NGCP Dashboard | Home | Documentation | Monitoring & Statistics

Subscriber Preferences for 43993006@10.15.20.133

← Back

Successfully updated ccmappings

- Call Forwards
- Voicemail and Voicebox
- Fax Features
- Speed Dial
- Reminder
- Callthrough CLIs**

★ Edit Callthrough CLIs

Show 5 entries | Search:

#	CLI	Source UUID
1	431234567890	8bb71bde-ab29-42cc-85dd-dff55e8b33d4

Showing 1 to 1 of 1 entries

Using Sipwise C5 Panel the user then creates Call Forward to destination *Call Through*.

6.21.2.2 Forward to local user

If the subscriber has a Call Forward to the call-through application but caller's CLI is not in the authorized CLIs list for call-through, sips responds with error back to proxy and proxy advances to the next number in the Call Forward destinations set. User can enter special destination *Local Subscriber* as next target after *Call Through* in the destinations set in order to terminate the call to the subscriber as if the subscriber didn't exist. This way the user may reach the call-through application from his authorized CLI (e.g. mobile number) and all other callers would reach the SIP subscriber's registered phone as usual.

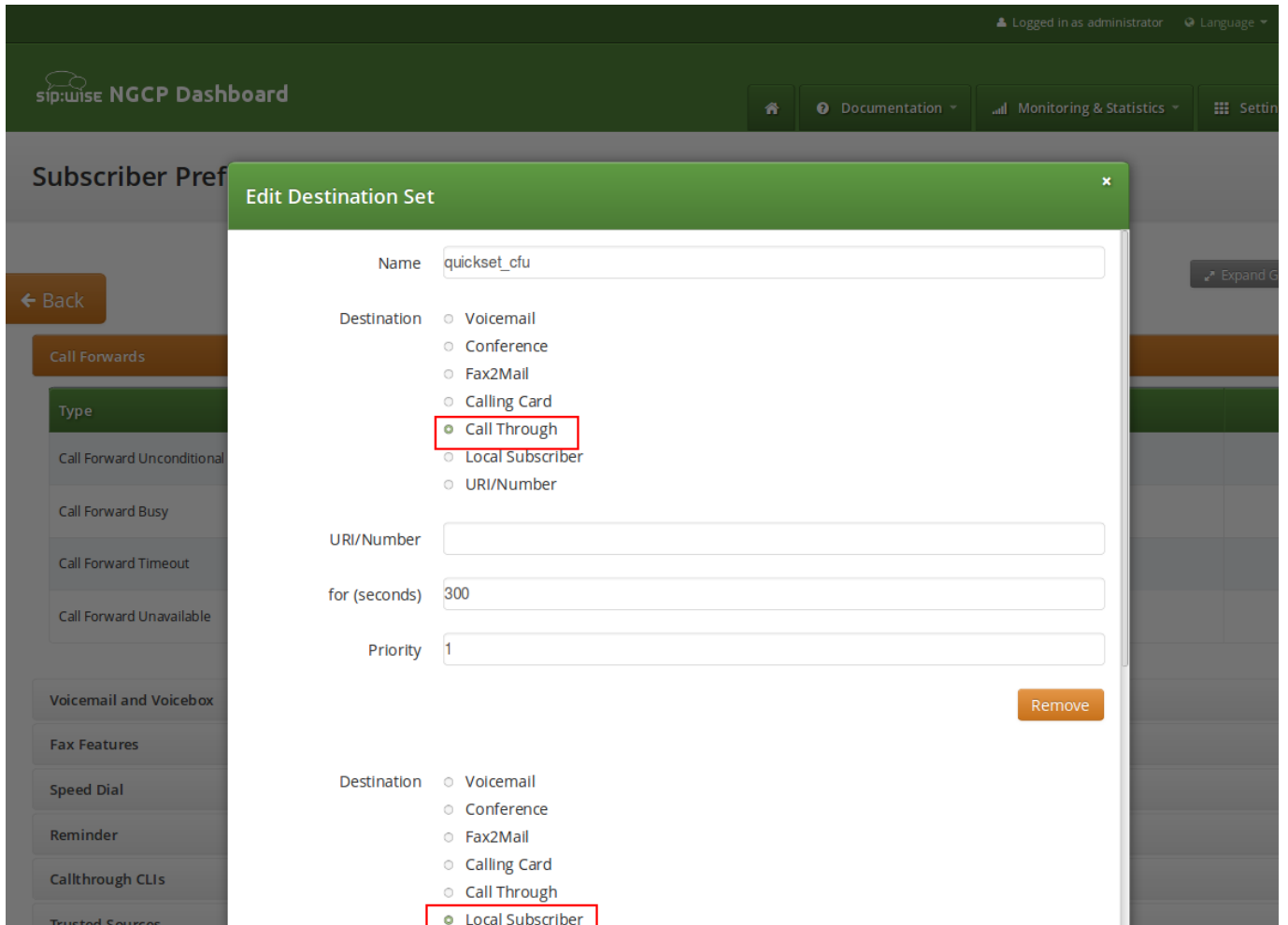

6.21.2.3 Sound Set provisioning

In order for the Callthrough application to work a Sound Set must be created and associated with the Domain or Subscriber.

Sound Sets can be defined in *Settings*→*Sound Sets*. To create a new Sound Set, click *Create Sound Set*. Then click the *Files* button. Administrator can upload the default sounds in one of supported languages or uploaded by the administrator manually in his language of choice.

There is a preference *sound_set* on Domain and Subscriber levels to link subscribers to the sound set that they should hear (as usual the subscriber preference overrides the domain one).



[🏠](#)
[📄 Documentation ▾](#)

Manage Sound Set Calling Card and Call-through

← Back
★ Load Default Files

Sound set successfully loaded with default files.

calling_card

Name	Filename	Loop
and	and.wav	<input type="checkbox"/>
busy_ringback_tone		<input type="checkbox"/>
calling_card_not_found	calling_card_not_found.wav	<input type="checkbox"/>
connecting	connecting.wav	<input type="checkbox"/>
could_not_connect	could_not_connect.wav	<input type="checkbox"/>

Note

You may use 8 or 16 bit mono WAV audio files for all of the voice prompts.

6.21.3 Call Flow

The call arrives at sems application server with Request-URI user `callthrough`.

6.21.3.1 Internal Header Parameters

The INVITE contains an extra SIP header `P-App-Param` with the following parameters:

Table 8: SIP Header parameters for call-through application

Name	Meaning
uuid	The internal UUID of the call-through subscriber

Table 8: (continued)

Name	Meaning
srcnumber	Caller's CLI for the authentication
outgoing_cli	New CLI to be used by sems application for the outgoing call leg

6.21.3.2 Caller authorization

Caller is authorized using mapping shown in table above: `select source_uuid from provisioning.voip_cc_mapping where uuid=$uuid and auth_key=$srcnumber;`

If the check fails return the configured error response code. Then proceed with the call setup as follows.

6.21.3.3 Outgoing call

Sems requests the user to enter destination and starts digit collection. Digit collection process is terminated after 5 seconds (configurable in sems config file) or by pressing the # key. User can start entering destination while the voice prompt is being played.

Sems sends INVITE to the proxy with Request-URI: `sip:$number@$outboundproxy;sw_domain=$subscriber.domain`

From: `$outgoing_cli`

On receiving the 401 or 407 response from the proxy the application authenticates using the digest credentials retrieved for the call-through subscriber from the `voip_subscribers` table: `select s.username, s.password, d.domain from provisioning.voip_subscribers s, provisioning.voip_domains d where s.uuid=$source_uuid and s.domain_id=d.id;`

If the call setup fails the application plays back the "could_not_connect" sound file. If successful the application acts transparently and does not provide any voice announcements or DTMF detection.

6.21.3.4 CLI configuration

The CLI on the outgoing call from the call-through module is set to the Network-Provided Number (NPN) of the call-through subscriber. There is nothing to configure.

6.22 Calling Card Application

Calling card application uses a similar concept to call-through except that authorization process operates on the PIN code entered by user using DTMF instead of the CLI. The Sipwise C5 maps incoming UUID of the pilot subscriber to the list of PINs for calling

card application with their corresponding subscriber UUIDs for outbound call leg using table `provisioning.voip_cc_mapping`
`table {"uuid", "auth_key", "source_uuid"}`

Table 9: Calling Cards

Column	Description
uuid	The internal UUID of the pilot subscriber
auth_key	Authentication key (PIN)
source_uuid	The internal UUID of the subscriber that is authorized for outgoing call leg

6.22.1 Administrative Configuration

6.22.1.1 Subscriber provisioning

In order to use the calling cards service the user creates a Call Forward to destination *Calling Card* for the designated subscriber that will be used as access number for this service.

6.22.1.2 Sound Set provisioning

In order for the Calling Card application to work a Sound Set must be created and associated with the Domain or Subscriber.

Sound Sets can be defined in *Settings*→*Sound Sets*. To create a new Sound Set, click *Create Sound Set*. Then click the *Files* button. Administrator can upload the default sounds in one of supported languages or uploaded by the administrator manually in his language of choice.

There is a preference *sound_set* on Domain and Subscriber levels to link subscribers to the sound set that they should hear (as usual the subscriber preference overrides the domain one).

sip:wise NGCP Dashboard

[🏠](#)
[📄 Documentation ▾](#)

Manage Sound Set Calling Card and Call-through

← Back
★ Load Default Files

Sound set successfully loaded with default files.

calling_card

Name	Filename	Loop	
and	and.wav	<input type="checkbox"/>	
busy_ringback_tone		<input type="checkbox"/>	
calling_card_not_found	calling_card_not_found.wav	<input type="checkbox"/>	
connecting	connecting.wav	<input type="checkbox"/>	
could_not_connect	could_not_connect.wav	<input type="checkbox"/>	

Note

You may use 8 or 16 bit mono WAV audio files for all of the voice prompts.

6.22.1.3 CLI configuration

The CLI on the outgoing call from the calling card app can be configured in one of the following ways using subscriber preferences:

1) Show original caller's CLI: the calling card subscriber shall have `allowed_clis: * (any)`. Sems application sends the original caller's CLI in the From header, it is validated by the SIP proxy and sent to outside.

2) Show number of the pilot (calling card) subscriber: the calling card subscriber shall have an empty `allowed_clis` and desired number set as value of `user_cli` preference. The SIP proxy overrides the original caller's CLI in UPN with the value of the `user_cli` preference. The peer must have set `outbound_from_user`, `outbound_from_display`: User-Provided Number (UPN).

6.22.2 Call Flow

The call arrives at sems application server with Request-URI user `callingcard`.

6.22.2.1 Internal Header Parameters

The INVITE contains an extra SIP header `P-App-Param` with the following parameters:

Table 10: SIP Header parameters for calling card application

Name	Meaning
<code>uuid</code>	The internal UUID of the pilot subscriber
<code>outgoing_cli</code>	New CLI to be used by sems application for the outgoing call leg

6.22.2.2 Caller authorization

- Sems requests the user to enter PIN and starts digit collection. Digit collection process is terminated after 5 seconds (configurable in sems config file) or by pressing the # key. User can start entering destination while the voice prompt is being played.
- Sems checks that PIN is valid and belongs to the pilot subscriber using mapping as shown in the table. It fetches UUID of the subscriber to be used for outgoing call leg: `select source_uuid from provisioning.voip_cc_mapping where uuid=$uuid and auth_key=$pin;`
- If the check fails sems will request the user to re-enter PIN up to the configured number of times.
- If successful proceed with the call setup making call on behalf of subscriber determined by the `source_uuid` key as follows.

6.22.2.3 Outgoing call

Sems application plays back the available balance of the customer. Sems requests the user to enter destination and starts digit collection. Digit collection process is terminated after 5 seconds (configurable in sems config file) or by pressing the # key. User can start entering destination while the voice prompt is being played.

Sems sends INVITE to the proxy with Request-URI: `sip:$number@$outboundproxy;sw_domain=$subscriber.domain`

From: `$outgoing_cli`

On receiving the 401 or 407 response from the proxy the application authenticates using the digest credentials retrieved for the subscriber for outgoing call leg from the `voip_subscribers` table: `select s.username, s.password, d.domain from provisioning.voip_subscribers s, provisioning.voip_domains d where s.uuid=$source_uuid and s.domain_id=d.id;`

6.22.2.4 Voucher recharge

During the destination collection phase in calling card application user can enter special code *1*<pin># (configurable in sems config file) to transfer balance from other calling card customer to the currently authorized customer. Sems transfers all remaining balance from that customer to the current customer.

6.22.2.5 Billing

The call via calling card application as well as call-through generates three CDRs:

- A to B: The incoming call from any source to the call-through subscriber.
- B to callingcard@app.local or callthrough@app.local: The call forward to the sems application.
- B to C: The outgoing call to the final destination. The three CDRs are handled by the billing process as usual, exported and shown in all call lists. .

6.23 Invoices and Invoice Templates

Content and vision of the invoices are customizable by [invoice templates](#).

Note

The Sipwise C5 generates invoices in pdf format.

6.23.1 Invoices Management

Invoices can be requested for generation, searched, downloaded and deleted on the administrative web interface. Navigate to *Settings* → *Invoices* menu and you get a list of all invoices currently stored in the database.

Tip

The system operator or a third party application can also generate, list, retrieve and delete invoices via the REST API. Please read further details [here](#).

Logged in as administrator | Language | Logout

sipwise NGCP Dashboard | Monitoring & Statistics | Settings

Invoices

← Back | ★ Create Invoice

Show 5 entries | Search:

#	Customer #	Customer Email	Serial	
1	9	ipeshinskaya@sipwise.com	INV2014070000001	Download Delete
2	9	ipeshinskaya@sipwise.com	INV2014080000002	
4	143	ipeshinskaya@sipwise.com	INV2014080000004	

Showing 1 to 3 of 3 entries

© 2013 Sipwise GmbH, all rights reserved.

To request invoice generation for the particular customer and period press "Create invoice" button. On the invoice creation form following parameters are available for selection:

- **Template:** any of existent invoice template can be selected for the invoice generation.
- **Customer:** owner of the billing account, recipient of the invoice.
- **Invoice period:** billing period. Can be specified only as one calendar month. Calls with start time between first and last second of the period will be considered for the invoice

All form fields are mandatory.

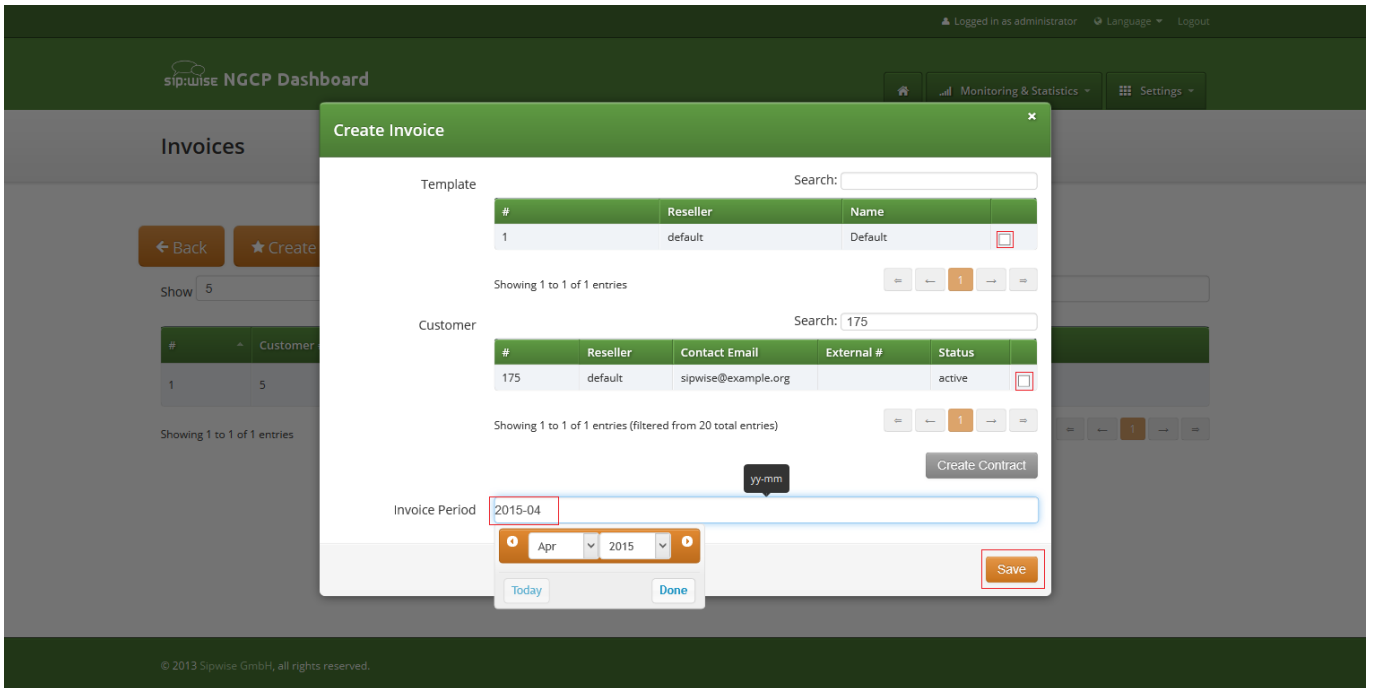

Generated invoice can be downloaded as pdf file.

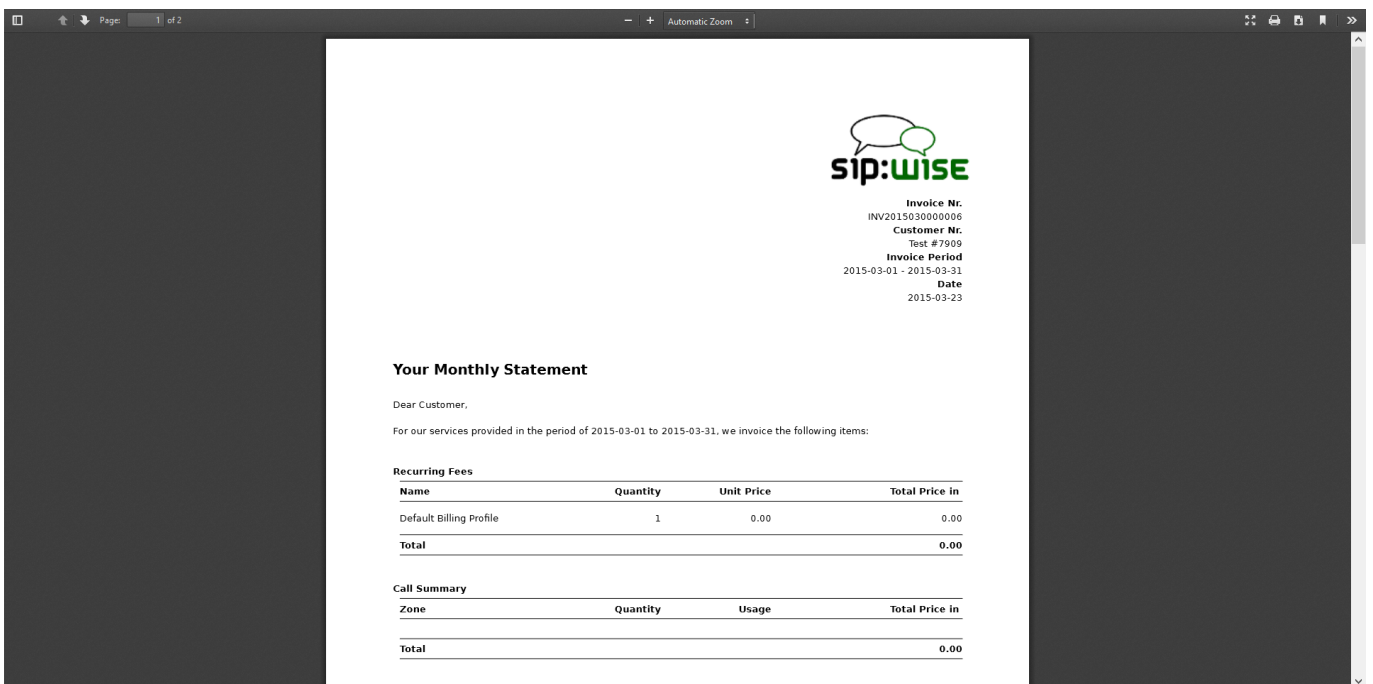

To do it press button "Download" against invoice in the invoice management interface.

Respectively press on the button "Delete" to delete invoice.

6.23.2 Invoice Management via REST API

Besides managing invoices on the admin web interface of NGCP, the system administrator (or a third party system) has the opportunity to request generation and retrieval of invoices via the *REST API*.

The subsequent sections describe the available operations for invoice management with API requests in details. All operations work on the *Invoices* resource and use the `/api/invoices` base path. The authentication method is username/password in the examples given below, however it is recommended to use a TLS client certificate for authentication on the REST API.

Note

The full API documentation is always available at the location: `https://<IP_of_NGCP_web_panel>:1443/api`

6.23.2.1 Generate a New Invoice

The **prerequisite** for generating a new invoice is that the customer has to have **an invoice template** assigned to him.

The following example shows a CURL command that will request generation of an invoice:

- for customer with ID "79"
- for the time period of November 2017
- based on the invoice template with ID "1"

```
curl -i -X POST -H 'Connection: close' -H 'Content-Type: application/json' \
--user adminuser:adminpwd -k 'https://127.0.0.1:1443/api/invoices/' \
--data-binary '{ "customer_id" : "79", "template_id" : "1", \
"period_start": "2017-11-01 00:00:00", "period_end": "2017-11-30 23:59:59" }'
```

Please note that in this operation we used the `/api/invoices` path (the *invoices* collection) and a *POST* request on it to create a new invoice item.

In case of a **successful operation**, Sipwise C5 will reply with **201 Created** HTTP status and send the ID of the invoice in *Location* header. In our example the new invoice item may be directly referred as `/api/invoices/3` (ID = 3).

```
HTTP/1.1 201 Created
Server: nginx
Date: Tue, 14 Nov 2017 13:38:40 GMT
Content-Length: 0
Connection: close
Location: /api/invoices/3
Set-Cookie: ngcp_panel_session=d5e4a8dd003fd7cac646653a6b5aefa703cf3e66; path=/; expires= ↵
Tue, 14-Nov-2017 14:38:38 GMT; HttpOnly
X-Catalyst: 5.90114
Strict-Transport-Security: max-age=15768000
```

In case of a **failed operation**, e.g. when we request an invoicing period that is invalid for the customer, Sipwise C5 will reply with **422 Unprocessable Entity** or **500 Internal Server Error** HTTP status.

6.23.2.2 Download Invoice Data

You can download properties / data of a specific invoice by selecting the item by its ID, using an HTTP *GET* request.

```
curl -i -X GET -H 'Connection: close' --user adminuser:adminpwd -k \  
'https://127.0.0.1:1443/api/invoices/3'
```

The above request will return a JSON data structure containing invoice properties:

```
HTTP/1.1 200 OK  
Server: nginx  
Date: Wed, 15 Nov 2017 12:13:04 GMT  
Content-Type: application/hal+json; profile="http://purl.org/sipwise/ngcp-api/"; charset= ↵  
utf-8  
Content-Length: 759  
Connection: close  
Link: </api/invoices/>; rel=collection  
Link: <http://purl.org/sipwise/ngcp-api/>; rel=profile  
Link: </api/invoices/3>; rel="item self"  
Link: </api/invoices/3>; rel="item http://purl.org/sipwise/ngcp-api/#rel-invoices"  
Link: </api/customers/79>; rel="item http://purl.org/sipwise/ngcp-api/#rel-customers"  
Set-Cookie: ngcp_panel_session=219fecbbe4fa936defd1ee511c84efe7b5a6d6a; path=/; expires= ↵  
Wed, 15-Nov-2017 13:13:03 GMT; HttpOnly  
Strict-Transport-Security: max-age=15768000  
  
{  
  "_links" : {  
    "collection" : {  
      "href" : "/api/invoices/"  
    },  
    "curies" : {  
      "href" : "http://purl.org/sipwise/ngcp-api/#rel-{rel}",  
      "name" : "ngcp",  
      "templated" : true  
    },  
    "ngcp:customers" : {  
      "href" : "/api/customers/79"  
    },  
    "ngcp:invoices" : {  
      "href" : "/api/invoices/3"  
    },  
    "profile" : {  
      "href" : "http://purl.org/sipwise/ngcp-api/"  
    },  
    "self" : {
```

```

    "href" : "/api/invoices/3"
  }
},
"amount_net" : 0,
"amount_total" : 0,
"amount_vat" : 0,
"id" : 3,
"period_end" : "2017-11-30T23:59:59+00:00",
"period_start" : "2017-11-01T00:00:00+00:00",
"sent_date" : null,
"serial" : "INV2017110000003"
}

```

It is also possible to query the complete *invoices* collection and use a filter (e.g. invoicing period, customer ID, etc.) to get the desired invoice item. In the example below we request all available invoices that belong to the customer with ID "79".

```

curl -i -X GET -H 'Connection: close' --user adminuser:adminpwd -k \
'https://127.0.0.1:1443/api/invoices/?customer_id=79'

```

The returned dataset is now slightly different because it is represented as an array of items, although in our example the array consist of only 1 item:

```

{
  "_embedded" : {
    "ngcp:invoices" : [
      {
        "_links" : {
          "collection" : {
            "href" : "/api/invoices/"
          },
          "curies" : {
            "href" : "http://purl.org/sipwise/ngcp-api/#rel-{rel}",
            "name" : "ngcp",
            "templated" : true
          },
          "ngcp:customers" : {
            "href" : "/api/customers/79"
          },
          "ngcp:invoices" : {
            "href" : "/api/invoices/3"
          },
          "profile" : {
            "href" : "http://purl.org/sipwise/ngcp-api/"
          },
          "self" : {

```



```
        "href" : "/api/invoices/3"
      }
    },
    "amount_net" : 0,
    "amount_total" : 0,
    "amount_vat" : 0,
    "id" : 3,
    "period_end" : "2017-11-30T23:59:59+00:00",
    "period_start" : "2017-11-01T00:00:00+00:00",
    "sent_date" : null,
    "serial" : "INV2017110000003"
  }
]
},
"_links" : {
  "curies" : {
    "href" : "http://purl.org/sipwise/ngcp-api/#rel-{rel}",
    "name" : "ngcp",
    "templated" : true
  },
  "ngcp:invoices" : {
    "href" : "/api/invoices/3"
  },
  "profile" : {
    "href" : "http://purl.org/sipwise/ngcp-api/"
  },
  "self" : {
    "href" : "/api/invoices/?page=1&rows=10"
  }
},
"total_count" : 1
}
```

6.23.2.3 Download Invoice as PDF File

You can download a specific invoice as a PDF file in the following way:

- selecting the item by its ID (as in our example, but you can also use a filter and query the complete *invoices* collection)
- using an HTTP *GET* request
- adding "**Accept: application/pdf**" header to the request

```
curl -X GET -H 'Connection: close' -H 'Accept: application/pdf' \  
--user adminuser:adminpwd -k 'https://127.0.0.1:1443/api/invoices/3' > result.pdf
```

Please note that in the example above we **do not add the "-i" option** that would also include the headers of the HTTP response in the output file. The output of the CURL command, i.e. the PDF file, is saved as "result.pdf" locally.

6.23.2.4 Delete an Invoice

In order to delete an invoice item you have to send a *DELETE* request on the specific item:

```
curl -i -X DELETE -H 'Connection: close' --user adminuser:adminpwd -k \
'https://127.0.0.1:1443/api/invoices/3'
```

In case of successful deletion Sipwise C5 should send HTTP status 204 No Content as a response:

```
HTTP/1.1 204 No Content
Server: nginx
Date: Wed, 15 Nov 2017 13:42:42 GMT
Connection: close
Set-Cookie: ngcp_panel_session=10b66a6baf25a09739c2bb2377c70eccee78387; path=/; expires= ↵
Wed, 15-Nov-2017 14:42:42 GMT; HttpOnly
X-Catalyst: 5.90114
Strict-Transport-Security: max-age=15768000
```

6.23.3 Invoice Templates

Invoice template defines structure and look of the generated invoices. The Sipwise C5 makes it possible to create some invoice templates. Multiple invoice templates can be used to send invoices to the different customers using different languages.



Important

At least one invoice template should be created to enable invoice generation. Each customer has to be associated to one of the existent invoice template, otherwise invoices will be not generated for this customer.

Customer can be linked to the invoice template in the customer interface.

6.23.3.1 Invoice Templates Management

Invoice templates can be searched, created, edited and deleted in the invoice templates management interface.

Logged in as administrator Language Logout

sip:wise NGCP Dashboard

Monitoring & Statistics Settings

Invoice Templates

← Back ★ Create Invoice Template

Search:

#	Reseller	Name	Type	
1	default	Default	svg	Edit Meta Edit Content Delete

Showing 1 to 1 of 1 entries

© 2013 Sipwise GmbH, all rights reserved.

Invoice template creation is separated on two steps:

- Register new invoice template meta information.
- Edit content (template itself) of the invoice template.

To register new invoice template press "Create Invoice Template" button.

On the invoice template meta information form following parameters can be specified:

- **Reseller:** reseller who owns this invoice template. Please note, that it doesn't mean that the template will be used for the reseller customers by default. After creation, invoice template still need to be linked to the reseller customers.
- **Name:** unique invoice template name to differentiate invoice templates if there are some.
- **Type:** currently Sipwise C5 supports only svg format of the invoice templates.

All form fields are mandatory.

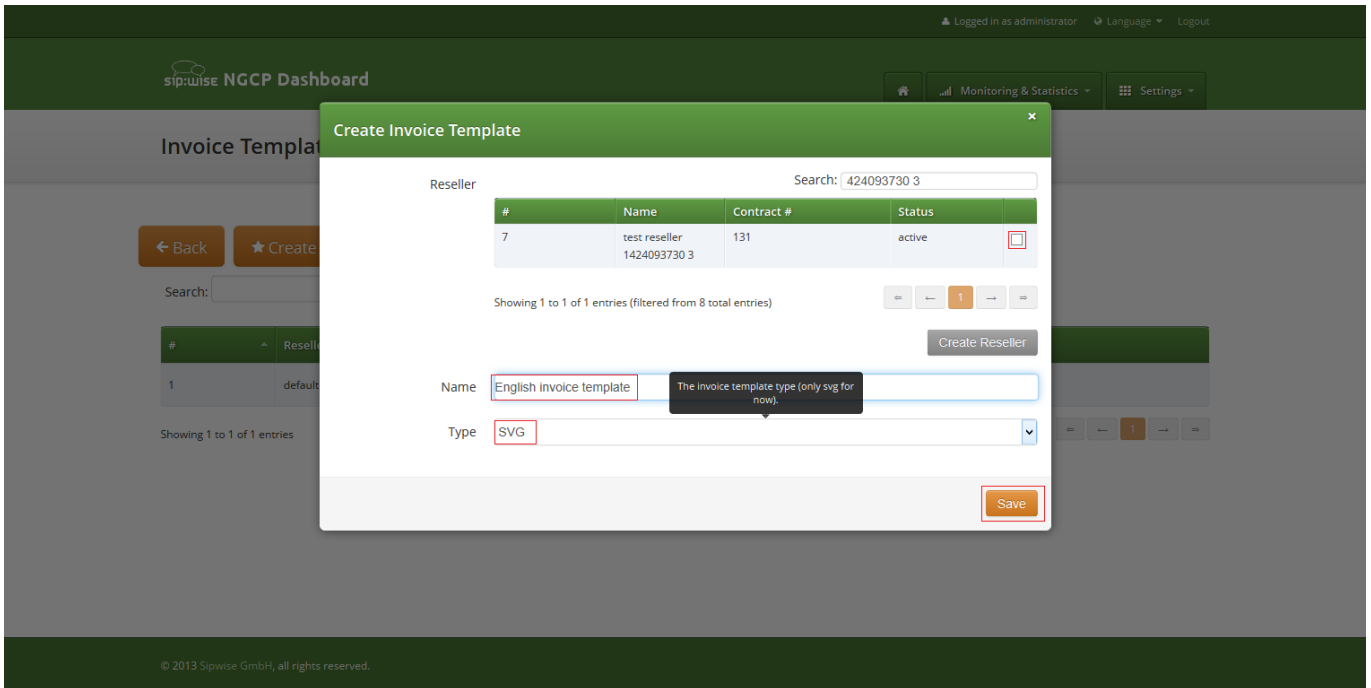

After registering new invoice template you can change invoice template structure in WYSIWYG SVG editor and preview result of the invoice generation based on the template.

6.23.3.2 Invoice Template Content

Invoice template is a XML SVG source, which describes content, look and position of the text lines, images or other invoice template elements. The Sipwise C5 provides embedded WYSIWYG SVG editor `svg-edit 2.6` to customize default template. The Sipwise C5 `svg-edit` has some changes in layers management, image edit, user interface, but this [basic introduction](#) still may be useful.

Template refers to the owner reseller contact ("rescontact"), customer contract ("customer"), customer contact ("custcontact"), billing profile ("billprof"), invoice ("invoice") data as variables in the "[%%]" mark-up with detailed information accessed as field name after point e.g. [%invoice.serial%]. During invoice generation all variables or other special tokens in the "[% %]" mark-ups will be replaced by their database values.

Press on "Show variables" button on invoice template content page to see full list of variables with the fields:

You can add/change/remove embedded variables references directly in main svg-edit window. To edit text line in svg-edit main window double click on the text and place cursor on desired position in the text.

After implementation of the desired template changes, invoice template should be [saved](#).

To return to Sipwise C5 invoice template **default** content you can press on the "Discard changes" button.



Important

"Discard changes" operation can't be undone.

Layers

Default template contains three groups elements (<g/>), which can be thought of as pages, or in terms of svg-edit - layers. Layers are:

- **Background:** special layer, which will be repeated as background for every other page of the invoice.
- **Summary:** page with a invoice summary.
- **CallList:** page with calls made in a invoice period. Is invisible by default.

To see all invoice template layers, press on "Layers" vertical sign on right side of the svg-edit interface:

One of the layers is active, and its element can be edited in the main svg-edit window. Currently active layer's name is **bold** in the layers list. The layers may be visible or invisible. Visible layers have "eye" icon left of their names in the layers list.

To make a layer active, click on its name in the layers list. If the layer was invisible, its elements became visible on activation. Thus you can see mixed elements of some layers, then you can switch off visibility of other layers by click on their "eye" icons. It is good idea to keep visibility of the "Background" layer on, so look of the generated page will be seen.

Edit SVG XML source

Sometimes it may be convenient to edit svg source directly and svg-edit makes it possible to do it. After press on the <svg> icon in the top left corner of the svg-edit interface:

SVG XML source of the invoice template will be shown.

SVG source can be edited in place or just copy-pasted as usual text.

Note

Template keeps sizes and distances in pixels.



Important

When edit svg xml source, please change very carefully and thoughtfully things inside special comment mark-up "`<!--{ }-->`". Otherwise invoice generation may be broken. Please be sure that document structure repeats default invoice template: has the same groups (`<g/>`) elements on the top level, text inside special comments mark-up "`<!--{ }-->`" preserved or changed appropriately, svg xml structure is correct.

To save your changes in the svg xml source, first press "OK" button on the top left corner of the source page:

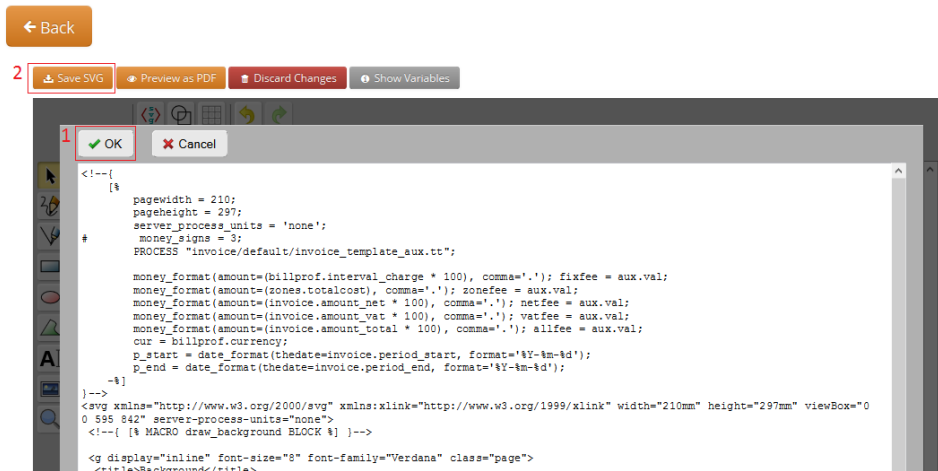
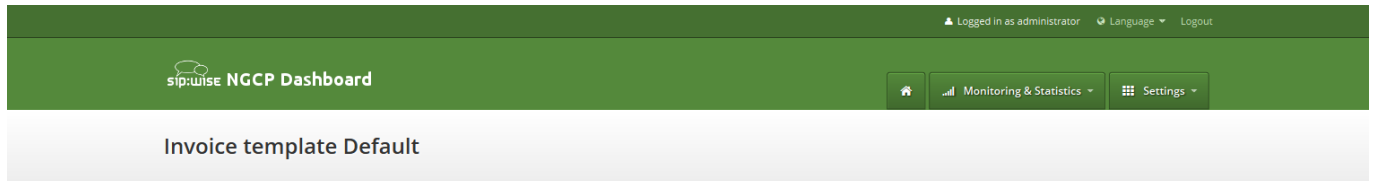

And then [save invoice template changes](#).

Note

You can copy and keep the svg source of your template as a file on the disk before start experimenting with the template. Later you will be able to return to this version replacing svg source.

Change logo image

- Make sure that "Select tool" is active.
- Select default logo, clicking on the logo image.
- Press "Change image" button, which should appear on the top toolbar.

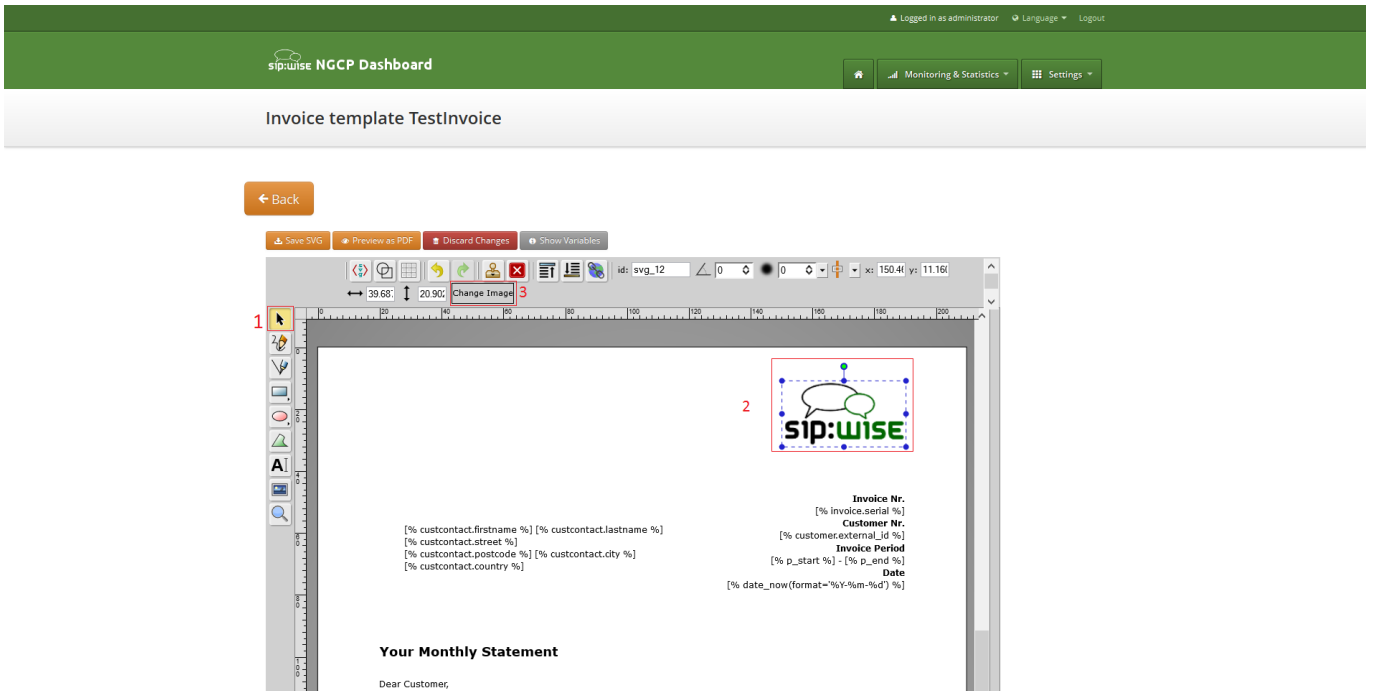

After image uploaded [save invoice template changes](#).

6.23.3.3 Save and preview invoice template content

To save invoice template content changes press button "Save SVG".

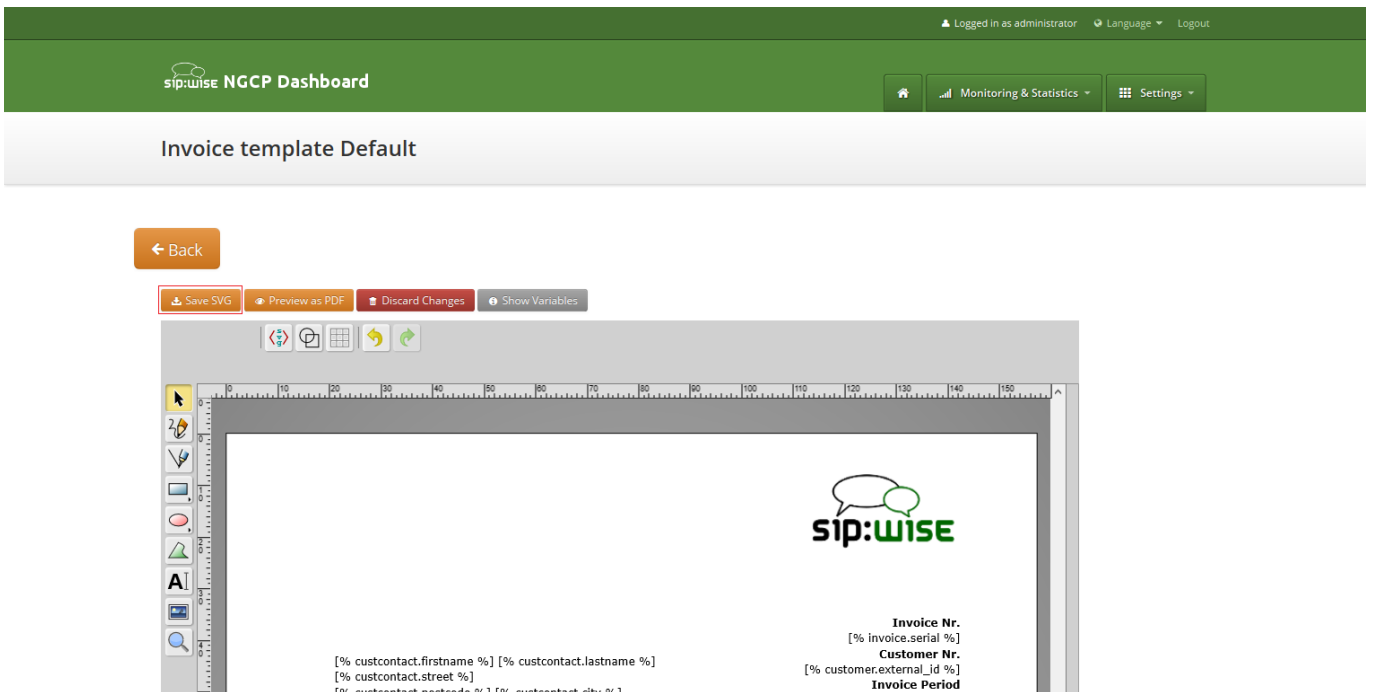

You will see message about successfully saved template. You can preview your invoice look in PDF format. Press on "Preview as PDF" button.

Logged in as administrator | Language | Logout

sip:wise NGCP Dashboard | Monitoring & Statistics | Settings

Invoice template Default

[← Back](#)

Invoice template successfully saved



Invoice preview will be opened in the new window.

Note

Example fake data will be used for preview generation.

Customer
 Customerfirst Customerlast
 Customerstreet 12/3
 12345 Customercity
 Customercountry

Invoice Nr.
1234567

Customer Nr.
Resext1234567890

Invoice Period
2015-04-01 - 2015-04-30

Date
2015-04-05

Your Monthly Statement

Dear Customer,

For our services provided in the period of 2015-04-01 to 2015-04-30, we invoice the following items:

Recurring Fees			
Name	Quantity	Unit Price	Total Price in EUR
Test Billing Profile	1	29.90	29.90
Total			29.90

6.24 Email Reports and Notifications

6.24.1 Email events

The Sipwise C5 makes it possible to customize content of the emails sent on the following actions:

- Web password reset requested. Email will be sent to the subscriber, whom password was requested for resetting. If the subscriber doesn't have own email, letter will be sent to the customer, who owns the subscriber.
- Administrator password reset requested. Email will be sent to the administrator, whom password was requested for resetting. If the administrator doesn't have an email, an error message will appear when requesting the password reset.
- New subscriber created. Email will be sent to the newly created subscriber or to the customer, who owns new subscriber.
- Letter with the invoice. Letter will be sent to the customer.

6.24.2 Initial template values and template variables

Default email templates for each of the email events are inserted on the initial Sipwise C5 database creation. Content of the default template is described in the corresponding sections. Default email templates aren't linked to any reseller and can't be changed through Sipwise C5 Panel. They will be used to initialize default templates for the newly created reseller.

Each email template refers to the values from the database using special mark-ups "[%" and "%]". Each email template has fixed set of the variables. Variables can't be added or changed without changes in Sipwise C5 Panel code.

6.24.3 Subscriber password reset email template

Email will be sent after subscriber or subscriber administrator requested password reset for the subscriber account. Letter will be sent to the subscriber. If subscriber doesn't have own email, letter will be sent to the customer owning the subscriber.

Default content of the password reset email template is:

Template name	passreset_default_email
From	default@sipwise.com
Subject	Password reset email
Body	<pre> Dear Customer, Please go to [%url%] to set your password and log into your self-care ← interface. Your faithful Sipwise system -- This is an automatically generated message. Do not reply.</pre>

Following variables will be provided to the email template:

- [%url%]: specially generated url where subscriber can define his new password.
- [%subscriber%]: `username@domain` of the subscriber, which password was requested for reset.

6.24.4 Administrator password reset email template

Email will be sent after administrator requested password reset for it's account. Letter will be sent to the administrator. If the administrator doesn't have an email, an error message will appear when requesting the password reset.

Default content of the password reset email template is:

Template name	admin_passreset_default_email
From	<code>default@sipwise.com</code>
Subject	Password reset email
Body	<pre> Dear Customer, Please go to [%url%] to set your password and log into your admin ← interface. Your faithful Sipwise system -- This is an automatically generated message. Do not reply.</pre>

Following variables will be provided to the email template:

- [%url%]: specially generated url where administrator can define his new password.
- [%admin%]: `username@domain` of the administrator, which password was requested for reset.

6.24.5 New subscriber notification email template

Email will be sent on the new subscriber creation. Letter will be sent to the newly created subscriber if it has an email. Otherwise, letter will be sent to the customer who owns the subscriber.

Note

By default email content template is addressed to the customer. Please consider this when create the subscriber with an email.

Template name	subscriber_default_email
----------------------	---------------------------------

From	default@sipwise.com
Subject	Subscriber created
Body	<p>Dear Customer,</p> <p>A new subscriber [%subscriber%] has been created for you.</p> <p>Your faithful Sipwise system</p> <p>--</p> <p>This is an automatically generated message. Do not reply.</p>

Following variables will be provided to the email template:

- [%url%]: specially generated url where subscriber can define his new password.
- [%subscriber%]: username@domain of the subscriber, which password was requested for reset.

6.24.6 Invoice email template

Template name	invoice_default_email
From	default@sipwise.com
Subject	Invoice #[%invoice.serial%] from [%invoice.period_start_obj.ymd%] to [%invoice.period_end_obj.ymd%]
Body	<p>Dear Customer,</p> <p>Please find your invoice #[%invoice.serial%] for [%invoice. ← period_start_obj.month_name%, [%invoice.period_start_obj.year%] in attachment letter.</p> <p>Your faithful Sipwise system</p> <p>--</p> <p>This is an automatically generated message. Do not reply.</p>

Variables passed to the email template:

- [%invoice%]: container variable for the invoice information.

Invoice fields

- [%invoice.**serial**%]
- [%invoice.**amount_net**%]
- [%invoice.**amount_vat**%]
- [%invoice.**amount_total**%]
- [%invoice.**period_start_obj**%]
- [%invoice.**period_end_obj**%]

The fields [%invoice.period_start_obj%] and [%invoice.period_end_obj%] provide methods of the perl package DateTime for the invoice start date and end date. Further information about DateTime can be obtained from the package documentation:
man DateTime

- [%**provider**%]: container variable for the reseller contact. All database contact values will be available.
- [%**client**%]: container variable for the customer contact.

Contact fields example for the "provider". Replace "provider" to client to access proper "customer" contact fields.

- [%provider.gender%]
- [%provider.firstname%]
- [%provider.lastname%]
- [%provider.comregnum%]
- [%provider.company%]
- [%provider.street%]
- [%provider.postcode%]
- [%provider.city%]
- [%provider.country%]
- [%provider.phonenumber%]
- [%provider.mobilenumber%]
- [%provider.email%]
- [%provider.newsletter%]
- [%provider.faxnumber%]
- [%provider.iban%]
- [%provider.bic%]
- [%provider.vatnum%]
- [%provider.bankname%]
- [%provider.gpp0 - provider.gpp9%]

6.24.7 Email templates management

Email templates linked to the resellers can be customized in the email templates management interface. For the administrative account email templates of all the resellers will be shown. Respectively for the reseller account only owned email templates will be shown.

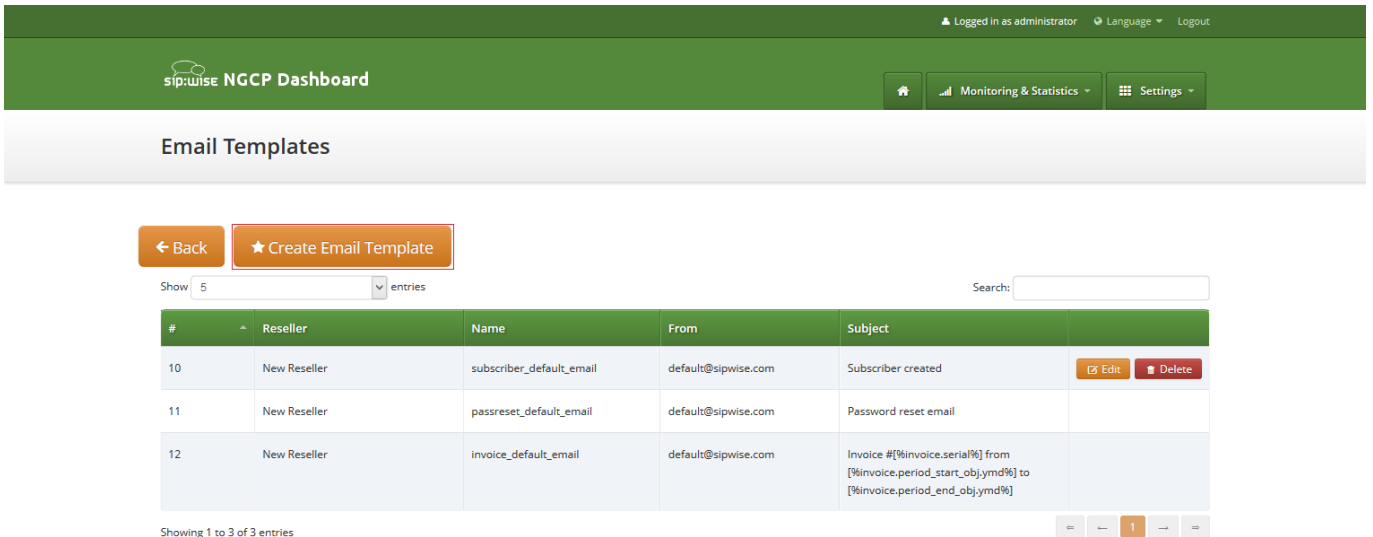

To create new email template press button "Create Email Template".

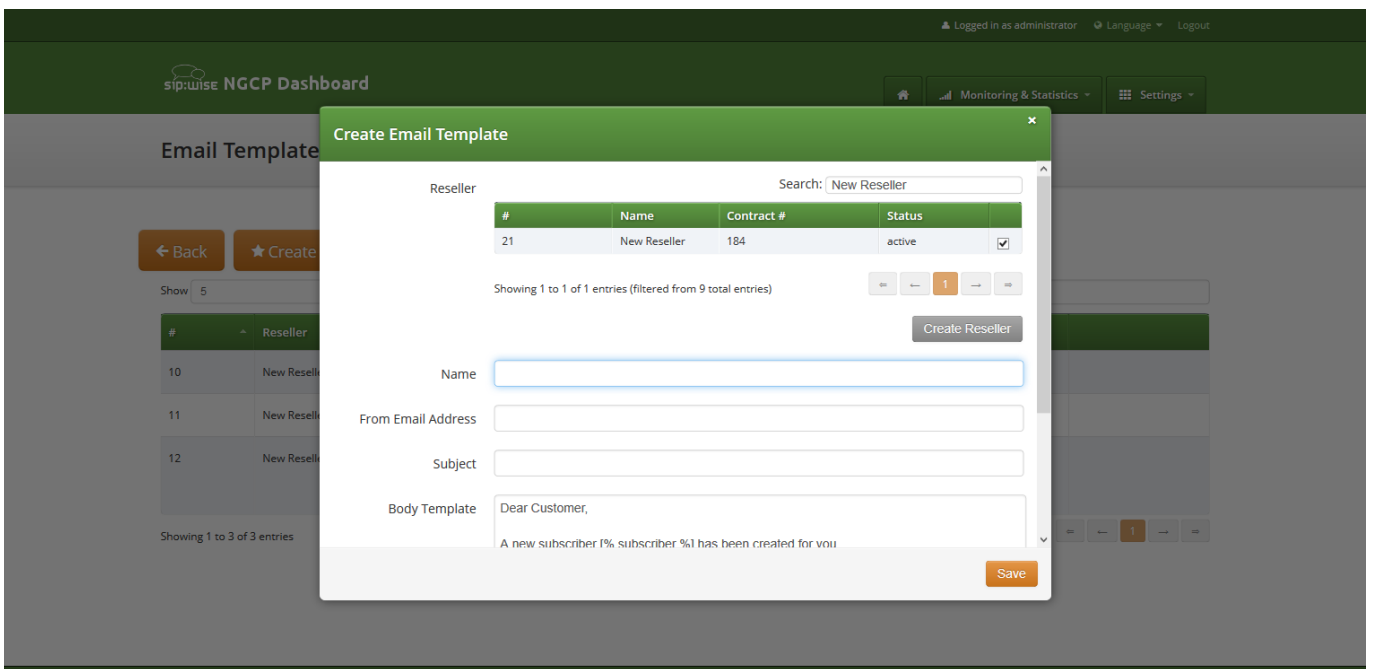

On the email template form all fields are mandatory:

- **Reseller:** reseller who owns this email template.
- **Name:** currently only email template with the following names will be considered by Sipwise C5 on the [appropriate event](#) :
 - admin_passreset_default_email;
 - passreset_default_email;
 - subscriber_default_email;

- invoice_default_email;
- **From Email Address:** email address which will be used in the From field in the letter sent by Sipwise C5 .
- **Subject:** Template of the email subject. Subject will be processed with the same template variables as the email body.
- **Body:** Email text template. Will be processed with appropriate template variables.

6.25 The Vertical Service Code Interface

Vertical Service Codes (VSC) are codes a user can dial on his phone to provision specific features for his subscriber account. The format is `*<code>*<value>` to activate a specific feature, and `#<code>` or `#<code>#` to deactivate it. The *code* parameter is a two-digit code, e.g. 72. The *value* parameter is the value being set for the corresponding feature.



Important

The *value* user input is normalized using the Rewrite Rules Sets assigned to domain as described in Section 5.7.

By default, the following codes are configured for setting features. The examples below assume that there is a domain rewrite rule normalizing the number format `0<ac><sn>` to `<cc><ac><sn>` using 43 as country code.

- **72** - enable *Call Forward Unconditional* e.g. to 431000 by dialing `*72*01000`, and disable it by dialing `#72`.
- **90** - enable *Call Forward on Busy* e.g. to 431000 by dialing `*90*01000`, and disable it by dialing `#90`.
- **92** - enable *Call Forward on Timeout* e.g. after 30 seconds of ringing to 431000 by dialing `*92*30*01000`, and disable it by dialing `#92`.
- **93** - enable *Call Forward on Not Available* e.g. to 431000 by dialing `*93*01000`, and disable it by dialing `#93`.
- **96** - disable at once all the *Call Forwards* previously configured using VSC, e.g. disable all the CFs by dialing `#96`.
- **50** - set *Speed Dial Slot*, e.g. set slot 1 to 431000 by dialing `*50*101000`, which then can be used by dialing `*1`. There is no code to disable a speed dial slot. When a slot is no longer necessary, it can be ultimately removed using the web interface or can be just ignored, because it is not impacting the calls from and to this subscriber.
- **55** - set *One-Shot Reminder Call* e.g. to 08:30 by dialing `*55*0830`.
- **31** - set *Calling Line Identification Restriction* for one call, e.g. to call 431000 anonymously dial `*31*01000`.
- **32** - enable *Block Incoming Anonymous Calls* by dialing `*32*`, and disable it by dialing `#32`.
- **80** - call using *Call Block Override PIN*, number should be prefixed with a block override PIN configured in admin panel to disable the outgoing user/admin block list and NCOS level for a call. For example, when override PIN is set to 7890, dial `*80*789001000` to call 431000 bypassing block lists.
- **95** - allow to redial the last dialed number by the subscriber. Note: the feature has to be enabled for the subscriber/domain using preference *last_number_redial*.

- **71** - allow to hear a voice announcement of the last caller's number, after the announcement dial the key defined in `sems→vsc→callback` to return the call. Note: it is not possible return a call if the caller's number is unavailable.
- **74** - allow to return the call to the last caller's number who called you without hearing the last call ID announcement. Note: it is not possible return a call if the caller's number is unavailable.
- **20** - allow to remove the records of the recent calls to and from you.



Important

In order to use the feature codes related to recent calls (**95**, **71**, **74**, **20**) the `kamailio→proxy→store_recentcalls` preference in `/etc/ngcp-config/config.yml` has to be set to `yes`. Additionally, to handle caller numbers coming from Peers (e.g. PSTN), set the `kamailio→proxy→foreign_domain_via_peer` preference to `yes` in `/etc/ngcp-config/config.yml` file.

6.25.1 Vertical Service Codes for PBX customers

Subscribers under the same PBX customer can enjoy some PBX-specific features by means of special VSCs.

Sipwise C5 provides the following PBX-specific VSCs:

- **97 - Call Parking:** during a conversation the subscriber can park the call with his phone to a "parking slot" and later on continue the conversation from another phone. To do that, a destination must be dialled as follows: `*97*3`; this will park the call to slot no. 3.

PLEASE NOTE:

- Cisco IP phones provide a softkey for Call Parking, that means the subscriber must only dial the parking slot number after pressing "Park" softkey on the phone.
- Other IP phones can perform Call Parking as a *blind transfer*, where the destination of the transfer must be dialled in the format described above.
- Both the caller and the callee can park the call.
- **98 - Call Unparking:** if a call has been parked, a subscriber may continue the conversation from any extension (phone) under the same PBX customer. To do that, the subscriber must dial the following sequence: `*98*3`; this will pick up the call that was parked at slot no. 3.
- **99 - Directed Call Pickup:** if a subscriber's phone is ringing (e.g. extension 23) and another subscriber wants to answer the call instead of the original callee, he may pick up the call by dialling `*99*23` on his phone.

6.25.2 Configuration of Vertical Service Codes

You can change any of the codes (but not the format) in `/etc/ngcp-config/config.yml` in the section `sems→vsc`. After the changes, execute `ngcpcfg apply "changed VSC codes"`.

**Caution**

If you have the EMAs under your control, make sure that the specified VSCs don't overlap with EMA-internal VSCs, because the VSC calls must be sent to Sipwise C5 via SIP like normal telephone calls.

6.25.3 Voice Prompts for Vertical Service Code Configuration

Table 11: VSC Voice Prompts

Prompt Handle	Related VSC	Message
vsc_error	any	An error has occurred. Please try again later.
vsc_invalid	wrong code	Invalid feature code.
reject_vsc	any	Vertical service codes are disabled for this line.
vsc_cfu_on	72 (Call Forward Unconditional)	Your unconditional call forward has successfully been activated.
vsc_cfu_off	72 (Call Forward Unconditional)	Your unconditional call forward has successfully been deactivated.
vsc_cfb_on	90 (Call Forward Busy)	Your call forward on busy has successfully been activated.
vsc_cfb_off	90 (Call Forward Busy)	Your call forward on busy has successfully been deactivated.
vsc_cft_on	92 (Call Forward on Timeout)	Your call forward on ring timeout has successfully been activated.
vsc_cft_off	92 (Call Forward on Timeout)	Your call forward on ring timeout has successfully been deactivated.
vsc_cfna_on	93 (Call Forward on Not Available)	Your call forward while not reachable has successfully been activated.
vsc_cfna_off	93 (Call Forward on Not Available)	Your call forward while not reachable has successfully been deactivated.
vsc_speeddial	50 (Speed Dial Slot)	Your speed dial slot has successfully been stored.
vsc_reminder_on	55 (One-Shot Reminder Call)	Your reminder has successfully been activated.
vsc_reminder_off	55 (One-Shot Reminder Call)	Your reminder has successfully been deactivated.
vsc_blockinclr_on	32 (Block Incoming Anonymous Calls)	Your rejection of anonymous calls has successfully been activated.
vsc_blockinclr_off	32 (Block Incoming Anonymous Calls)	Your rejection of anonymous calls has successfully been deactivated.

6.26 Handling WebRTC Clients

WebRTC is an open project providing browsers and mobile applications with Real-Time Communications (RTC) capabilities. Configuring your platform to offer WebRTC is quite easy and straightforward. This allows you to have a SIP-WebRTC bridge in place and make audio/video call towards normal SIP users from WebRTC clients and vice versa. Sipwise C5 listens, by default, on the following WebSockets and WebSocket Secure: `ws://your-ip:5060/ws`, `wss://your-ip:5061/ws` and `wss://your-ip:1443/wss/sip/`.

The WebRTC subscriber is just a normal subscriber which has just a different configuration in his Preferences. You need to change the following preferences under *Subscribers*→*Details*→*Preferences*→*NAT and Media Flow Control*:

- **use_rtproxy**: Always with `rtproxy` as additional ICE candidate
- **transport_protocol**: RTP/SAVPF (encrypted SRTP with RTCP feedback)

The `transport_protocol` setting may change, depending on your WebRTC client/browser configuration. Supported protocols are the following:

- Transparent (Pass through using the client's transport protocol)
- RTP/AVP (Plain RTP)
- RTP/SAVP (encrypted SRTP)
- RTP/AVPF (RTP with RTCP feedback)
- RTP/SAVPF (encrypted SRTP with RTCP feedback)
- UDP/TLS/RTP/SAVP (Encrypted SRTP using DTLS)
- UDP/TLS/RTP/SAVPF (Encrypted SRTP using DTLS with RTCP feedback)



Warning

The below configuration is enough to handle a WebRTC client/browser. As mentioned, you may need to tune a little bit your `transport_protocol` configuration, depending on your client/browser settings.

In order to have a bridge between normal SIP clients (using plain RTP for example) and WebRTC client, the normal SIP clients' preferences have to have the following configuration:

transport_protocol: RTP/AVP (Plain RTP)

This will teach Sipwise C5 to translate between Plain RTP and RTP/SAVPF when you have calls between normal SIP clients and WebRTC clients.

6.27 XMPP and Instant Messaging

Instant Messaging (IM) based on XMPP comes with Sipwise C5 out of the box. Sipwise C5 uses `prosody` as internal XMPP server. Each subscriber created on the platform have assigned a XMPP user, reachable already - out of the box - by using the same SIP credentials. You can easily open an XMPP client (e.g. Pidgin) and login with your SIP `username@domain` and your SIP `password`. Then, using the XMPP client options, you can create your buddy list by adding your buddies in the format `user@domain`.

6.28 Call Recording

6.28.1 Introduction to Call Recording Function

Sipwise C5 provides an opportunity to record call media content and store that in files. This function is available since mr5.3.1 version of Sipwise C5 .

Some characteristics of the Call Recording:

- Call Recording function can store both unidirectional (originating either from caller, or from callee) or bidirectional (combined) streams from calls, resulting in 1, 2 or 3 physical files as output
- The location and format of the files is configurable.
- File storage is planned to occur on an NFS shared folder.
- Activation of call recording may happen generally for a *Domain / Peer / Subscriber* through Sipwise C5 admin web interface.



Important

NGCP's Call Recording function is not meant for individual call interception purpose! Sipwise provides its Lawful Interception solution for that use case.

- Querying or deletion of existing recordings may happen through the REST API.
- Listing recordings of a subscriber is possible on NGCP's admin web interface.

The Call Recording function is implemented using NGCP's *rtengine* module.

Note

There are 2 *rtengine* daemons employed when call recording is enabled and active. The *main rtengine* takes care of forwarding media packets between caller and callee, as usual, while the *secondary rtengine* (recording) daemon is responsible for storing call data streams in the file system.

Call Recording is disabled by default. Enabling and configuration of Call Recording takes place in 2 steps:

1. Enabling the feature on Sipwise C5 by setting configuration parameters in the main `config.yml` configuration file.
2. Activating the feature for a *Domain / Peer / Subscriber*.

6.28.2 Information on Files and Directories

NGCP's Call Recording function uses an **NFS shared folder** to save recorded streams.



Important

Since call data amount may be huge (depending, of course, on the number and duration of calls), it is *strongly not recommended* to store recorded streams on NGCP's local disks. However if you *have to* store recorded streams as files in the local filesystem, please contact Sipwise Support team in order to get the proper configuration of Call Recording function.

The NFS share gets mounted during startup of the recording daemon. If the NFS share cannot be mounted for some reason, the recording daemon will not start.

Filenames have the format: `<call_ID>-<random>-<SSRC>.<extension>`, where:

- `call_ID`: SIP Call-ID of the call being recorded
- `random`: is a string of random characters, unique for each recorded call. Its purpose is to avoid possible filename collisions if a Call-ID ever gets reused.
- `SSRC`: is the RTP SSRC for unidirectional recordings, or "mix" for the bidirectional (combined) audio.
- `extension`: is either "mp3" or "wav", depending on the configuration (`rtpproxy.recording.output_format`)

There might be 1, 2 or 3 files produced as recorded streams. The **number of files** depends on the configuration:

1. `rtpproxy.recording.output_mixed = 'yes'` (combined stream required)
`rtpproxy.recording.output_single = 'no'` (unidirectional streams not required)
2. `rtpproxy.recording.output_mixed = 'no'` (combined stream not required)
`rtpproxy.recording.output_single = 'yes'` (unidirectional streams required)
3. `rtpproxy.recording.output_mixed = 'yes'` (combined stream required)
`rtpproxy.recording.output_single = 'yes'` (unidirectional streams required)

6.28.3 Configuration

The Call Recording function can be enabled and configured on Sipwise C5 by changing the following configuration parameters in `config.yml` file:

```
rtpproxy:
  ...
  recording:
    enable: no
```

```

mp3_bitrate: '48000'
nfs_host: 192.168.1.1
nfs_remote_path: /var/recordings
output_dir: /var/lib/rtpengine-recording
output_format: wav
output_mixed: yes
output_single: yes
resample: no
resample_to: '16000'
spool_dir: /var/spool/rtpengine

```

6.28.3.1 Enabling Call Recording

Enabling the function requires changing the value of `rtpproxy.recording.enable` parameter to “yes”. In order to make the new configuration active, it's necessary to do:

```
ngcpcfg apply 'Activated call recording'
```

Description of configuration parameters:

- `enable`: when set to “yes” Call Recording function is enabled; default: “no”
- `mp3_bitrate`: the bitrate used when recording happens in MP3 format; default: "48000"
- `nfs_host`: IP address of the NFS host that provides storage space for recorded streams; default: "192.168.1.1"
- `nfs_remote_path`: the remote path (folder) where files of recorded streams are stored on the NFS share; default: "/var/recordings"
- `output_dir`: is the local mount point for the NFS share, and thus where the final audio files will be written; default: "/var/lib/rtpengine-recording"



Caution

Normally you don't need to change the default setting. If you do change the value, please be aware that recorded files will be written by `root` user in that directory.

- `output_format`: possible values are “wav” (Wave) or “mp3” (MP3); default: “wav”
- `output_mixed`: “yes” means that there is a file that contains a mixed stream of caller and callee voice data; default: "yes"
- `output_single`: “yes” means that there is a separate file for each stream direction, i.e. for the streams originating from caller and callee; default: "yes"
- `resample`: when set to “yes” the call data stream will be resampled before storing it in the file; default: “no”
- `resample_to`: the sample rate used for resampling output; default: "16000"

- `spool_dir`: is the place for temporary metadata files that are used by the recording daemon and the main `rtengine` daemon for their communication; default: `"/var/spool/rtengine"`



Caution

You should not change the default setting unless you have a good reason to do so! Sipwise has thoroughly tested the Call Recording function with the default setting.

If Call Recording is enabled you can see 2 `rtengine` processes running when checking Sipwise C5 system state with `ngcp-service` tool:

```
root@sp1:/etc/ngcp-config# ngcp-service summary
Ok Service                               Managed   Started   Status
-----
...
  kamailio-lb                             managed   by-ha     active
  ngcp-voisniff                            managed   by-ha     active
  rtengine                                 managed   by-ha     active
  rtengine-recording                       managed   by-ha     active
...
```

6.28.3.2 Activating Call Recording

Activating Call Recording for e.g. a *Subscriber*: please use NGCP's admin web interface for this purpose. On the web interface one has to navigate as follows: *Settings* → *Subscribers* → *select subscriber Details* → *Preferences* → *NAT and Media Flow Control*. Afterwards the `record_call` option has to be enabled by pressing the *Edit* button and ticking the checkbox.

NAT and Media Flow Control				
	Attribute	Name	Value	
	sound_set	System Sound Set	<input type="text"/>	
	use_rtpproxy	RTP-Proxy Mode	use domain default	
	ipv46_for_rtpproxy	IPv4/IPv6 bridging mode	use domain default	
	contract_sound_set	Customer Sound Set	<input type="text"/>	
	music_on_hold	Music on Hold	<input type="checkbox"/>	
	bypass_rtpproxy	Disable RTP-Proxy in the selected case	use domain default	
	rtp_interface	RTP interface	default	
	transport_protocol	Media transport protocol	use domain default	
	set_moh_sendonly	MoH sendonly	<input type="checkbox"/>	
	codecs_filter	Codecs filter	<input type="checkbox"/>	
	codecs_list	Codecs list		
	record_call	Record calls	<input type="checkbox"/>	Edit

Figure 75: Activating Call Recording

Note

The call recording function may be activated for a single *Subscriber*, a *Domain* and a *Peer* server in the same way: *Preferences* → *NAT and Media Flow Control* → *record_call*. When activating call recording for a *Domain* or *Peer* this effectively activates the function for all subscribers that belong to the selected domain, and for all calls with a local endpoint going through the selected peer server, respectively.

It is possible to **list existing call recordings** of a *Subscriber* through the admin web interface of NGCP. In order to do so, please navigate to: *Settings* → *Subscribers* → *select subscriber Details* → *Call Recordings*

Subscriber 43993002@10.15.18.222

← Back | Preferences | Calls history | Customer | Expand Groups

Master Data
Groups
Voice Mails
Call Recordings

From Date: To Date: Search:

#	Time	Call-ID	
1	2017-09-05 11:51:41.543	17d5b961-7613-4ba2-9bc4-fb8086e2ccdd	<input type="button" value="Call Details"/> <input type="button" value="Recorded Files"/> <input type="button" value="Delete"/>

Showing 1 to 1 of 1 entries

Figure 76: Listing Call Recordings

If you select an item in the list, besides the main properties such as the time of call and the SIP Call-ID, you can retrieve the details of the related call (press the *Call Details* button), get the list of recorded files (press the *Recorded Files* button) or *Delete* the recorded call.

When selecting *Call Details* you will see the most important accounting data of the call. Furthermore you can see the SIP *Call Flow* or the complete *Call Details* if you press the respective buttons.

Call List for 43993002@10.15.18.222 ()

← Back

Show all calls

Show 5 entries From Date: To Date: Search:

#	Caller	Callee	CLIR	Billing zone	Status	Start Time	Duration	Call-ID	Cost	
5	43993002	43993003	0	All Destinations	ok	2017-09-05 11:51:47.855	0:00:10.437	17d5b961-7613-4ba2-9bc4-fb8086e2ccdd	0.00	<input type="button" value="Call Flow"/> <input type="button" value="Call Details"/>
Total							0:00:10.437		0.00	

Showing 1 to 1 of 1 entries

Figure 77: Listing Call Details for a Recording

When navigating to *Recorded Files* of a call you will be presented with a list of files. For each file item:

- type of stream is shown, that can be either "mixed" (combined voice data), or "single" (voice data of caller or callee)

- file `format` is shown, that can be either "wav", or "mp3"
- you can download the file by pressing the *Play* button

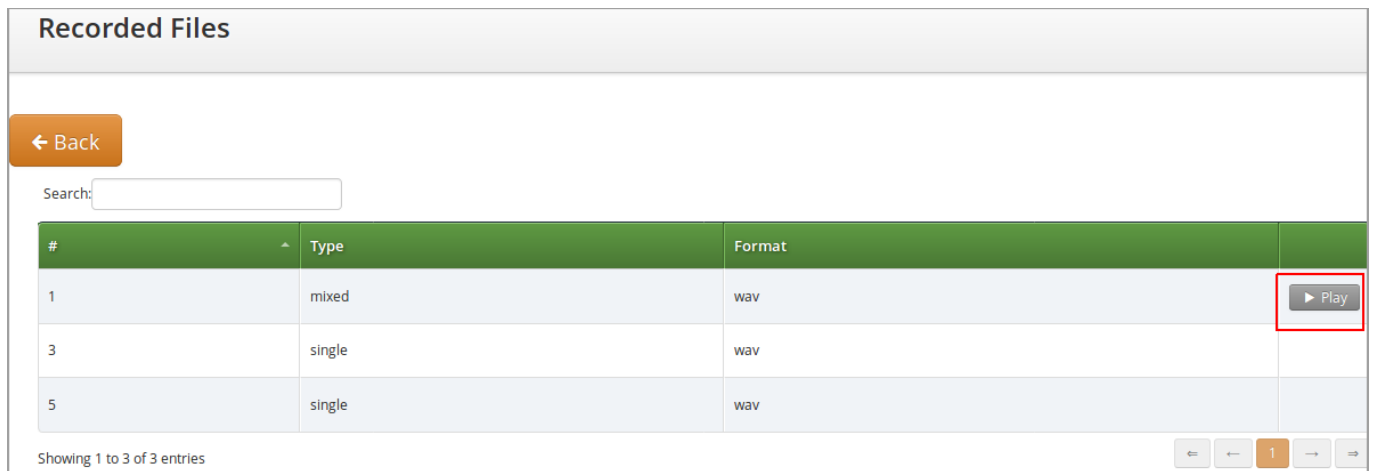

#	Type	Format	
1	mixed	wav	
3	single	wav	
5	single	wav	

Showing 1 to 3 of 3 entries

Figure 78: Listing Files for a Recording

6.28.4 REST API

The Sipwise C5 REST API provides methods for querying and deletion of existing recording data. The full documentation of the available API methods is available on the admin web interface of the NGCP, as usual.

The following API methods are provided for managing Call Recordings:

- CallRecordings:
 - Provides information about the calls recorded in the system; can also be used to delete a recording entry
 - accessible by the path: `/api/callrecordings` (collection) or `/api/callrecordings/id` (single item)
 - Supported HTTP methods: OPTIONS, GET, DELETE
- CallRecordingStreams:
 - Provides information about recorded streams, such as start time, end time, format, mixed/single type, etc.; can also be used to delete a recorded stream
 - accessible by the path: `/api/callrecordingstreams` (collection) or `/api/callrecordingstreams/id` (single item)
 - Supported HTTP methods: OPTIONS, GET, DELETE
- CallRecordingFiles:
 - Provides information about recorded streams, such as start time, end time, format, mixed/single type, etc.; additionally returns the file content too
 - accessible by the path: `/api/callrecordingfiles` (collection) or `/api/callrecordingfiles/id` (single item)
 - Supported HTTP methods: OPTIONS, GET

6.28.5 Pre-Recording Announcement

Many country regulations require that an informative announcement is played to the caller before the call is actually recorded. The Sipwise C5 allows you to configure your own custom announcement with few simple steps.

First create a system sound set for the feature. In *Settings* → *Sound Sets* either use your already existing *Sound Set* or create a new *Sound Set* and then assign it to your domain or subscribers. In the *Sound Set* there is an announcement *early_rejects* → *announce_before_recording* for that purpose.

Once the *Sound Set* is created the subscriber's preference *play_announce_before_recording* of the callee must be enabled under *Subscriber* → *Preferences* → *Applications* menu. The same parameter can be set in the Domain's or Customer's preferences to enable this feature for all its subscribers.

Note

The announcement will be played to caller before the call is routed to the callee.



Important

In case of **CFU** or **CFNA** with Pre-Recording Announcement feature enabled on both the forwarder and the final callee, only the Announcement of final callee will be played to caller. In case of **CFB** and **CFT**, instead, the announcement of the forwarder will be played first, then the announcement of final callee will be played after the call forward is executed.

6.29 Media Transcoding

6.29.1 Overview

Starting with version mr6.2.1, Sipwise C5 offers the capability to convert RTP media between several supported codecs, a feature known as transcoding. While this feature is always available on Sipwise C5, it's engaged only when a subscriber, peer, or domain is explicitly configured for it. By default, Sipwise C5 lets RTP endpoints negotiate the codec to use among themselves without interfering.



Important

Media transcoding is a relatively CPU-intensive feature. As such, each individual node of a Sipwise C5 performing media transcoding can only support a limited number of concurrent calls for which transcoding is active.

6.29.2 Supported Codecs

The following audio codecs, which are commonly found in use by SIP/RTP clients, are currently supported for transcoding.

- G.711 (μ -Law and a-Law)
- G.722

- G.723.1
- G.729
- GSM
- AMR (narrowband and wideband, the latter also known as AMR-WB)
- Opus
- Speex
- DTMF event packets (**telephone-event**)

Some codecs operate at different sampling rates than other codecs. If transcoding happens between two such codecs, the audio will be resampled as necessary. Similarly, if transcoding happens between a mono (1-channel) and a stereo (2-channel) codec, the audio will be up-mixed and down-mixed as necessary.

6.29.3 Configuration

Transcoding can be engaged for individual subscribers, peers, or domains on their respective preferences page in the Sipwise C5 admin web interface.

Media Codec Transcoding Options			
Attribute	Name	Value	
<input checked="" type="checkbox"/>	ptime	RTP packet interval	use domain default ▾
<input checked="" type="checkbox"/>	transcode_PCMU	Transcode to G.711 μ-Law	<input type="checkbox"/>
<input checked="" type="checkbox"/>	transcode_PCMA	Transcode to G.711 a-Law	<input type="checkbox"/>
<input checked="" type="checkbox"/>	transcode_G722	Transcode to G.722	<input type="checkbox"/>
<input checked="" type="checkbox"/>	transcode_G723	Transcode to G.723.1	<input type="checkbox"/>
<input checked="" type="checkbox"/>	transcode_G729	Transcode to G.729	<input type="checkbox"/>
<input checked="" type="checkbox"/>	transcode_GSM	Transcode to GSM	<input type="checkbox"/>
<input checked="" type="checkbox"/>	transcode_AMR	Transcode to AMR	<input type="checkbox"/>
<input checked="" type="checkbox"/>	transcode_AMR_WB	Transcode to AMR-WB	<input type="checkbox"/>
<input checked="" type="checkbox"/>	transcode_opus_mono	Transcode to Opus mono	<input type="checkbox"/>
<input checked="" type="checkbox"/>	transcode_opus_stereo	Transcode to Opus stereo	<input type="checkbox"/>
<input checked="" type="checkbox"/>	transcode_speex_8	Transcode to Speex 8 kHz	<input type="checkbox"/>
<input checked="" type="checkbox"/>	transcode_speex_16	Transcode to Speex 16 kHz	<input type="checkbox"/>
<input checked="" type="checkbox"/>	transcode_speex_32	Transcode to Speex 32 kHz	<input type="checkbox"/>
<input checked="" type="checkbox"/>	opus_mono_bitrate	Opus mono bitrate	use domain default ▾
<input checked="" type="checkbox"/>	opus_stereo_bitrate	Opus stereo bitrate	use domain default ▾
<input checked="" type="checkbox"/>	g723_bitrate	G.723.1 bitrate	use domain default ▾
<input checked="" type="checkbox"/>	always_transcode	Always transcode media from the user	<input type="checkbox"/>

Figure 79: Transcoding Configuration

Setting any of the transcoding options for a domain makes it affect all the subscribers in this domain.

Individual options are described below.

6.29.3.1 ptime

Packetisation time in milliseconds. Normally Sipwise C5 lets the RTP endpoints select and negotiate the packetisation time they want to use. Setting this option to anything other than `unchanged` will engage the transcoding engine towards this subscriber or peer even if none of the other transcoding options are set, in which case the media will simply be repacketised.

For example, setting this to `40 ms` would mean that each RTP packet sent towards this subscriber or peer would contain 40 milliseconds worth of audio, even if the other side of the call sends media that is packetised differently. It would also make Sipwise C5 indicate towards this subscriber or peer that it would prefer to receive audio in 40 millisecond packets (through the `a=ptime` SDP attribute).

6.29.3.2 transcode_...

Enabling one of these options adds the selected codecs to the list of codecs offered to this subscriber or peer, even if the original list of offered codecs did not include it. If this additional codec ends up being accepted by this subscriber or peer, then it will be transcoding to the first supported codec that was originally offered.

For example, if a calling RTP client A indicates support for PCMA (G.711 a-Law) as well as G.722, and calls a subscriber B that is configured for transcoding to G.729, then subscriber B would be offered PCMA, G.722, and G.729 by Sipwise C5. If subscriber B then accepts G.729 and starts sending G.729, Sipwise C5 would engage its transcoding engine and transcode the audio to PCMA (because PCMA and not G.722 was the codec preferred by A) before forwarding it to A. Vice versa, PCMA arriving from A would be transcoded to G.729 before being sent to B. (If B were to reject G.729 and instead starts to send PCMA or G.722, no transcoding would happen.)

Notes on individual codecs:

- **AMR** is available in both narrowband (`AMR` operating at 8 kHz) and wideband (`AMR-WB` operating at 16 kHz) variants. These are distinct codecs and can be configured for transcoding separately or together.
- **Opus** always operates at 48 kHz, but is supported in both mono and stereo (1 and 2 audio channels respectively). Both can be offered at the same time if so desired.
- **Speex** is supported at sampling rates of 8, 16, and 32 kHz. These can be configured separately for transcoding, or together.
- **DTMF** is not an actual audio codec, but rather represents transcoding between DTMF event packets and in-band DTMF audio tones. This is described in more detail below.

6.29.3.3 ..._bitrate

Some codecs (Opus and G.723.1 in particular) can be configured for different bitrates, which would impact the amount of network bandwidth they use, as well as the audio quality produced. For Opus, different bitrates can be selected for their mono and stereo instances. Selecting a bitrate has no effect if transcoding to the respective codec is not engaged.

6.29.3.4 `always_transcode`

Setting this flag instructs Sipwise C5 to always engage transcoding to the first (preferred) codec indicated by an RTP endpoint, even if another codec is available that is supported by both parties to a call. Enabling this flag can potentially engage the transcoding engine for a call even if none of the other transcoding options are set.

For example: Subscriber A is calling subscriber B. Subscriber A is indicating support for PCMA and G.722. Subscriber B answers the call, rejects PCMA but accepts G.722, and starts sending G.722 to A. Normally Sipwise C5 would not get involved and would simply let G.722 pass between A and B. But if subscriber B has the `always_transcode` flag set, Sipwise C5 would now start transcoding the G.722 sent by B into PCMA before forwarding it to A, because PCMA was indicated as the preferred codec by A. Vice versa, PCMA arriving from A would be transcoded into G.722 and then forwarded to B.

6.29.3.5 DTMF transcoding

Sipwise C5 supports transcoding between DTMF event packets (using the RTP `telephone-event` type payload) and DTMF tones carried in-band in the audio stream. DTMF transcoding is supported in both directions: transcoding DTMF event packets to DTMF tones, and DTMF tones in an audio stream and transcoding them to DTMF event packets.

Support for DTMF transcoding can be enabled in one of two ways:

- Enabling the setting `transcode_dtmf` for a subscriber, peer, or domain. This is useful if the subscriber, peer, or domain requires support for DTMF event packets, but the calling entity might only support DTMF tones carried in-band in the audio stream.
- Enabling the setting `always_transcode` for a subscriber, peer, or domain. This is useful for the reverse case: if the subscriber, peer, or domain might only support DTMF tones carried in-band in the audio stream, but the calling entity requires support for DTMF event packets.

Enabling DTMF transcoding for any call requires that all audio passes through the transcoding engine, as well as a DSP for detecting DTMF tones in one direction. This carries an additional performance impact with it, and so DTMF transcoding should only be enabled when really necessary.

6.29.3.6 DTMF conversion of INFO messages

Sipwise C5 supports the conversion of SIP INFO messages with `application/dtmf-relay` payload to DTMF event or PCM DTMF inband tone, depending on whether the destination participant supports the `telephone-event` RTP payload type or not. DTMF conversion of INFO messages works only in one way direction: DTMF events or PCM DTMF inband tones are not converted back to DTMF INFO messages.

The preference `kamailio.proxy.allow_info_method` has to be set to `yes` in `config.yml` in order to make the DTMF INFO message conversion working.

Enabling DTMF conversion of INFO messages for any call requires that all audio passes through the transcoding engine, as well as a DSP for detecting DTMF tones in one direction. This carries an additional performance impact with it, and so it should only be enabled when really necessary.

Note

At the moment this feature is for internal use only. External generated INFO messages will be not converted but passed through.

6.29.4 T.38 transcoding

In addition to transcoding between audio codecs, Sipwise C5 supports transcoding between T.38 fax transmissions (over UDPTL transport) and T.30 fax data over regular audio channels. The audio codec commonly used to carry T.30 data is G.711, but any other audio codec that is supported for transcoding can also be used, provided it offers a high enough bitrate and audio quality.

Two settings to control T.38 transcoding are available for subscribers, peers, and domains:

- The setting `t38_decode` instructs Sipwise C5 to accept an offered T.38 session towards the subscriber, peer, or domain, and translate it into a regular audio call carrying T.30 fax data. By default, G.711 (both μ -Law and a-Law) will be offered. If any other codecs are selected through the `transcode_...` options, then only those codecs will be offered and the G.711 default will be omitted. Non-T.38 offers are not affected by this settings.
- The setting `t38_force` forces any audio call towards this subscriber, peer, or domain to be translated to a T.38 session, regardless of whether the audio media actually carries T.30 fax data or not. This is useful if it is known that the remote destination is a fax endpoint supporting T.38.

6.30 Announcement Before Call Setup

This feature allows a callee to play a custom announcement to the caller every time it receives a call. The announcement is played in early media mode, therefore it can be used as a simple business welcome message or to inform the caller about a different cost of the call before it will be actually charged.

The configuration of the announcement is similar to the activation of [Pre-Recording Announcement](#) and it requires few simple steps.

First create a system sound set for the feature. In *Settings* → *Sound Sets* either use your already existing *Sound Set* or create a new *Sound Set* and then assign it to your domain or subscribers. In the *Sound Set* there is an announcement `early_rejects` → `announce_before_call_setup` for that purpose.

Once the *Sound Set* is created the subscriber's preference `play_announce_before_call_setup` must be enabled under *Subscriber* → *Preferences* → *Applications* menu. The same parameter can be set in the Domain's or Customer's preferences to enable this feature for all its subscribers.

Note

The announcement will be played to caller before the call is routed to the callee.

**Important**

Differently from *Pre-Recording Announcement*, in all **Call Forward** cases with *Announcement Before Call Setup* feature enabled on both the forwarder and the final callee, only the announcement of the forwarder will be played to caller.

This feature and *Pre-Recording Announcement* can be activated at the same time. In this case the *Announcement Before Call Setup* will be played as first.

6.31 Announcement To Callee

This feature allows a caller to play a custom announcement to the callee every time it performs a call. The announcement is played to the callee immediately after it answers the call (200OK is received by Sipwise C5), therefore it can be used to provide some information about the caller. Meanwhile the callee is listening the announcement, the caller is still in ringing status. The parties will be put in connection right after the end of the announcement.

The configuration of the announcement is similar to the activation of [Pre-Recording Announcement](#) and it requires few simple steps.

First create a system sound set for the feature. In *Settings* → *Sound Sets* either use your already existing *Sound Set* or create a new *Sound Set* and then assign it to your domain or subscribers. In the *Sound Set* there is an announcement *early_rejects* → *announce_to_callee* for that purpose.

Once the *Sound Set* is created the caller subscriber's preference *play_announce_to_callee* must be enabled under *Subscriber* → *Preferences* → *Applications* menu. The same parameter can be set in the Domain's or Customer's preferences to enable this feature for all its subscribers.

Note

The announcement length is limited to 30 seconds.



Important

Differently from *Pre-Recording Announcement*, in all **Call Forward** cases with *Announcement To Callee* feature enabled on both the caller and the forwarder, only the announcement of the forwarder will be played to callee.

6.32 Store Recent Calls and Redial

Sipwise C5 allows to store the number of the last incoming and outgoing calls of each subscriber. To enable the feature edit `config.yml` and enable there `kamailio: store_recentcalls: yes`. Only the very last incoming and outgoing call is stored.

Each subscriber can interact with his own personal stored records using Vertical Service Codes (see [VSC](#)). In particular a subscriber can:

- redial last dialed number (this feature has to be enabled for the each subscriber/domain using preference *last_number_redial*)
- hear a voice announcement of the last caller's number, then press the key defined in `sems` → `vsc` → `callback_last_caller_confirmation_key` preference of `/etc/ngcp-config/config.yml` to return the call

- return the call to the last caller's number without hearing the number announcement
- delete the personal stored records of any recent calls to and from him

Note

it is not possible return a call if the caller's number is unavailable (e.g. anonymous calls).

6.32.1 Configuring Recent Calls Sound Sets

Sound Sets can be defined in *Settings*→*Sound Sets*. To create a new Sound Set, click *Create Sound Set*. Then click the *Files* button.

Name	Filename	Loop	
recent_call_anonymous		<input type="checkbox"/>	Upload
recent_call_confirmation		<input type="checkbox"/>	
recent_call_deleted		<input type="checkbox"/>	
recent_call_empty		<input type="checkbox"/>	
recent_call_play_number		<input type="checkbox"/>	

Upload the following files:

Table 12: Recent Calls Sound Sets

Handle	Message played
recent_call_play_number	The last call you received was from
recent_call_confirmation	To call back this number press key
recent_call_anonymous	The last caller didn't share his number, you can not return the call to this person.
recent_call_empty	Your recent call history is empty.
recent_call_deleted	Your recent call history has been successfully deleted.

Note

You may use 8 or 16 bit mono WAV audio files.

Then set the preference *sound_set* on the Domain or Subscriber level in order to assign the Sound Set (as usual the subscriber preference overrides the domain one).

6.32.2 Advanced configuration

By default the expiration time for the most recent incoming and outgoing call per subscriber are 3600 seconds (1 hour) and 86400 seconds (1 day) respectively. If you wish to prolong or shorten the expiration time open `constants.yml` and set there `recentcalls: expire: 3600` and `recentcalls: out_expire: 86400` to a new value, then issue `ngcpcfg apply "recentcalls expire modification"` afterwards.

6.33 SMS (Short Message Service) on Sipwise C5

Starting with its mr5.0.1 release, Sipwise C5 offers *short messaging service* to its local subscribers. The implementation is based on a widely used software module: *Kannel*, and it needs to interact with a mobile operator's SMSC in order to send and receive SMS for the local subscribers. The data exchange with SMSC uses *SMPP* (Short Message Peer-to-Peer) protocol.

SMS directions:

- incoming / received: the destination of the SM is a local subscriber on the NGCP
- outgoing / sent: the SM is submitted by a local subscriber

Note

The Sipwise C5 behaves as a short message client towards the SMSC of a mobile operator. This means every outgoing SM will be forwarded to the SMSC, and every incoming SM will reach Sipwise C5 through an SMSC.

The architecture of the SMS components of Sipwise C5 and their interaction with other elements is depicted below:

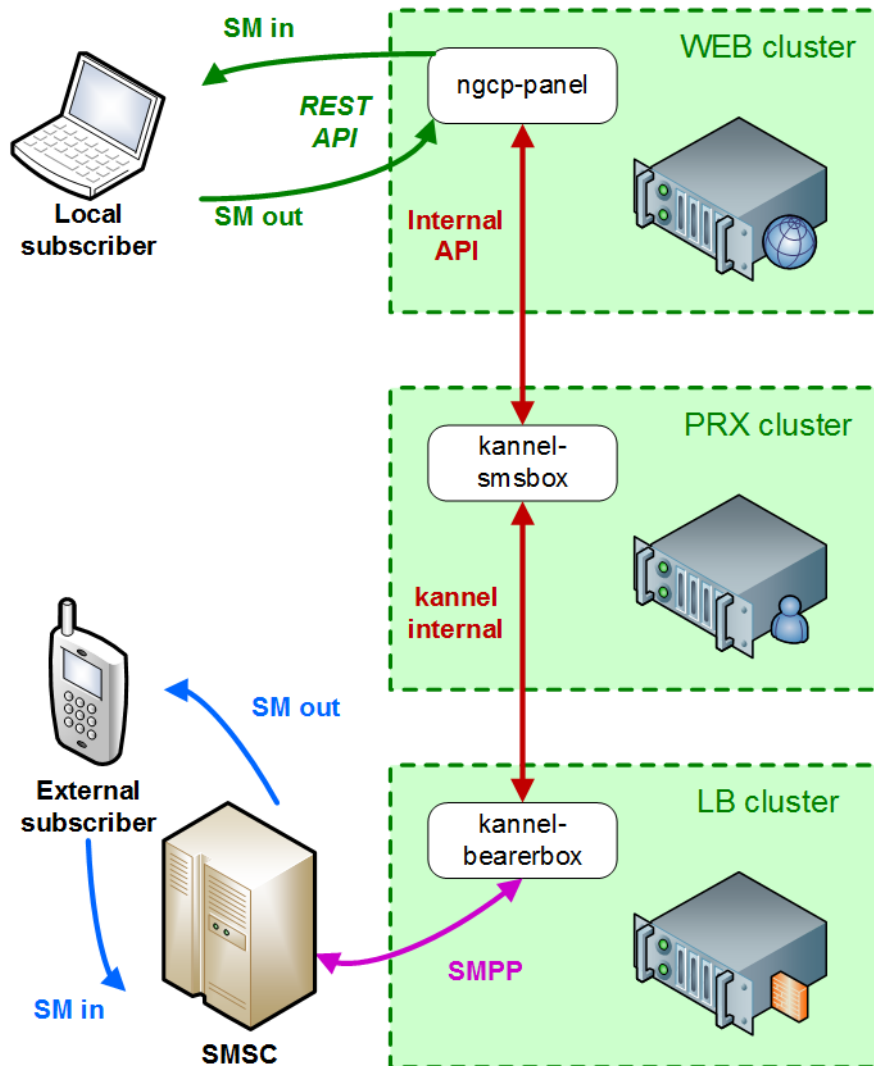

Figure 80: SMS Interaction

Note

For the *Sipwise C5 CE and PRO* installations: the *Kannel* components and the *ngcp-panel* all run on the same single node. The description of SMS module will continue referring to a *Sipwise C5 CARRIER* installation in the handbook.

There are 2 components of the SMS module:

- **SMS Box:** this component takes care of handling the messages locally, that means:
 - delivering them to subscribers (writing into database for later retrieval)
 - picking up the submitted SMSs from the database and forwarding them to the *Bearer Box* component
- **Bearer Box:** this component manages the transmission of SMSs between Sipwise C5 and the mobile operator's SMSC

6.33.1 Configuration

6.33.1.1 Main Parameters

The SMS functionality of Sipwise C5 is disabled by default. In order to **enable SMS**, change the value of configuration parameter `sms.enable` to `yes` in the main configuration file (`/etc/ngcp-config/config.yml`).

The second step of configuration is related to the **SMSC** where Sipwise C5 will connect to. Set the following parameters:

- `sms.smsc.host`: IP address of the SMSC
- `sms.smsc.port`: Port number of the SMSC
- `sms.smsc.username`: Username for authentication on the SMSC
- `sms.smsc.password`: Password for authentication on the SMSC

Other parameters of the SMSC connection may also need to be changed from the default values, but this is specific to each deployment.

Then, as usual, you have to make the new configuration active:

```
$ ngcpcfg apply 'Enabled SMS'  
$ ngcpcfg push all
```

6.33.1.2 Configuration Files of Kannel

There are a few configuration files for the *Kannel* module, namely:

- `/etc/default/ngcp-kannel`: determines which components of *Kannel* will be started. This is auto-generated from `/etc/ngcp-config/templates/etc/default/ngcp-kannel.tt2` file when SMS is enabled.
- `/etc/kannel/kannel.conf`: contains detailed configuration of *Kannel* components. This is auto-generated from `/etc/ngcp-config/templates/etc/kannel/kannel.conf.tt2` file when SMS is enabled.
- `/etc/logrotate.d/ngcp-kannel.conf`: configuration of *logrotate* for *Kannel* log files. This is auto-generated from `/etc/ngcp-config/templates/etc/logrotate.d/ngcp-kannel.conf.tt2` file when SMS is enabled.



Caution

Please do not change settings in the above mentioned template files, unless you have to tailor *Kannel* settings to your specific needs!

Finally: see the description of each configuration parameter in the [appendix](#).

6.33.1.3 Call Forwarding for SMS (CFS)

Any subscriber registered on Sipwise C5 can apply a call forwarding setting for short messages, referred to as "CFS" (Call Forward - SMS). If the CFS feature is enabled, he can receive the SMs on his mobile phone, for example, instead of retrieving the SMs through the REST API. This is much more convenient for users if they do not have an application on their smartphone or computer that could manage the SMs through the REST API.

In order to enable CFS you have to set the forwarding as usual on the admin web interface, or through the REST API. Navigate to *Subscribers* → *select one* → *Details* → *Preferences* → *Call Forwards* and press the *Edit* button.

Subscriber Preferences for 43993003@10.15.18.222

← Back Expand Groups

Successfully saved Call Forward

Call Forwards

Type	Answer Timeout	Destinations	Timeset	Sources	
Call Forward Unconditional					
Call Forward Busy					
Call Forward Timeout					
Call Forward Unavailable					
Call Forward SMS		435551234101@10.15.18.222	for 300s	always	all sources Edit Delete

Figure 81: Call Forward for SMS

6.33.2 Monitoring, troubleshooting

6.33.2.1 Bearer Box (LB node of NGCP)

On the LB node you can see a **process** named "**bearerbox**". This process has 2 **listening ports** assigned to it:

- 13000: this is the generic *Kannel* administration port, that belongs to the "core" component of Kannel.
- 13001: this is the communication port towards the *SMS Box* component running on PRX nodes of NGCP.

The *ngcp-service* tool also shows the *bearerbox* process in its summary information:

```
$ ngcp-service summary
Ok Service                Managed   Started   Status
-----
```

```
...
kannel-bearerbox          managed    by-ha     active
...
```

The following log files can provide information about the operation of *Bearer Box*:

- status messages and high level, short entries about sent and received messages: `/var/log/ngcp/kannel/kannel.log`

```
...
2017-09-26 08:57:32 [15922] [10] DEBUG: boxc_receiver: heartbeat with load value 0 ↔
    received
...
2017-09-26 11:12:06 [15922] [10] DEBUG: boxc_receiver: sms received
2017-09-26 11:12:06 [15922] [10] DEBUG: send_msg: sending msg to box: <192.168.1.4>
2017-09-26 11:12:06 [15922] [11] DEBUG: send_msg: sending msg to box: <192.168.1.4>
2017-09-26 11:12:06 [15922] [11] DEBUG: boxc_sender: sent message to <192.168.1.4>
2017-09-26 11:12:06 [15922] [10] DEBUG: boxc_receiver: got ack
...
```

- detailed information and message content of sent and received messages, link enquiries: `/var/log/kannel/smsc.log`

Note

Sent and received message examples shown here do not contain the full phone number and content for confidentiality reason.

- Example received message:

```
...
2017-09-26 12:09:36 [15922] [6] DEBUG: SMPP[default_smsc]: Got PDU:
2017-09-26 12:09:36 [15922] [6] DEBUG: SMPP PDU 0x7f2274025070 dump:
2017-09-26 12:09:36 [15922] [6] DEBUG:   type_name: deliver_sm
2017-09-26 12:09:36 [15922] [6] DEBUG:   command_id: 5 = 0x00000005
2017-09-26 12:09:36 [15922] [6] DEBUG:   command_status: 0 = 0x00000000
2017-09-26 12:09:36 [15922] [6] DEBUG:   sequence_number: 11867393 = 0x00b51501
2017-09-26 12:09:36 [15922] [6] DEBUG:   service_type: NULL
2017-09-26 12:09:36 [15922] [6] DEBUG:   source_addr_ton: 2 = 0x00000002
2017-09-26 12:09:36 [15922] [6] DEBUG:   source_addr_npi: 1 = 0x00000001
2017-09-26 12:09:36 [15922] [6] DEBUG:   source_addr: "0660....."
2017-09-26 12:09:36 [15922] [6] DEBUG:   dest_addr_ton: 1 = 0x00000001
2017-09-26 12:09:36 [15922] [6] DEBUG:   dest_addr_npi: 1 = 0x00000001
2017-09-26 12:09:36 [15922] [6] DEBUG:   destination_addr: "43668....."
2017-09-26 12:09:36 [15922] [6] DEBUG:   esm_class: 0 = 0x00000000
2017-09-26 12:09:36 [15922] [6] DEBUG:   protocol_id: 0 = 0x00000000
2017-09-26 12:09:36 [15922] [6] DEBUG:   priority_flag: 0 = 0x00000000
2017-09-26 12:09:36 [15922] [6] DEBUG:   schedule_delivery_time: NULL
```



```

2017-09-26 12:09:36 [15922] [6] DEBUG:   validity_period: NULL
2017-09-26 12:09:36 [15922] [6] DEBUG:   registered_delivery: 0 = 0x00000000
2017-09-26 12:09:36 [15922] [6] DEBUG:   replace_if_present_flag: 0 = 0x00000000
2017-09-26 12:09:36 [15922] [6] DEBUG:   data_coding: 3 = 0x00000003
2017-09-26 12:09:36 [15922] [6] DEBUG:   sm_default_msg_id: 0 = 0x00000000
2017-09-26 12:09:36 [15922] [6] DEBUG:   sm_length: 158 = 0x0000009e
2017-09-26 12:09:36 [15922] [6] DEBUG:   short_message:
2017-09-26 12:09:36 [15922] [6] DEBUG:     Octet string at 0x7f227400f80:
2017-09-26 12:09:36 [15922] [6] DEBUG:       len: 158
2017-09-26 12:09:36 [15922] [6] DEBUG:       size: 159
2017-09-26 12:09:36 [15922] [6] DEBUG:       immutable: 0
2017-09-26 12:09:36 [15922] [6] DEBUG:       data: 5a <14 bytes> 46
2017-09-26 12:09:36 [15922] [6] DEBUG:       data: 72 <14 bytes> 68
2017-09-26 12:09:36 [15922] [6] DEBUG:       data: 61 <14 bytes> 67
2017-09-26 12:09:36 [15922] [6] DEBUG:       data: 20 <14 bytes> 57
2017-09-26 12:09:36 [15922] [6] DEBUG:       data: 65 <14 bytes> 63
2017-09-26 12:09:36 [15922] [6] DEBUG:       data: 68 <14 bytes> 73
2017-09-26 12:09:36 [15922] [6] DEBUG:       data: 2e <14 bytes> 61
2017-09-26 12:09:36 [15922] [6] DEBUG:       data: 6c <14 bytes> 73
2017-09-26 12:09:36 [15922] [6] DEBUG:       data: 3a <14 bytes> 73
2017-09-26 12:09:36 [15922] [6] DEBUG:       data: 4d <14 bytes> 6e
2017-09-26 12:09:36 [15922] [6] DEBUG:     Octet string dump ends.
2017-09-26 12:09:36 [15922] [6] DEBUG: SMPP PDU dump ends.
2017-09-26 12:09:36 [15922] [6] DEBUG: SMPP[default_smsc]: Sending PDU:
2017-09-26 12:09:36 [15922] [6] DEBUG: SMPP PDU 0x7f2274020790 dump:
2017-09-26 12:09:36 [15922] [6] DEBUG:   type_name: deliver_sm_resp
2017-09-26 12:09:36 [15922] [6] DEBUG:   command_id: 2147483653 = 0x80000005
2017-09-26 12:09:36 [15922] [6] DEBUG:   command_status: 0 = 0x00000000
2017-09-26 12:09:36 [15922] [6] DEBUG:   sequence_number: 11867393 = 0x00b51501
2017-09-26 12:09:36 [15922] [6] DEBUG:   message_id: NULL
2017-09-26 12:09:36 [15922] [6] DEBUG: SMPP PDU dump ends.
2017-09-26 12:09:36 [15922] [6] DEBUG: SMPP[default_smsc]: throughput (0.00,5.00)
...

```

– Example sent message:

```

...
2017-09-26 12:04:08 [15922] [6] DEBUG: SMPP[default_smsc]: throughput (0.00,5.00)
2017-09-26 12:04:08 [15922] [6] DEBUG: SMPP[default_smsc]: Manually forced source addr ↔
   ton = 1, source add npi = 1
2017-09-26 12:04:08 [15922] [6] DEBUG: SMPP[default_smsc]: Manually forced dest addr ton ↔
   = 1, dest add npi = 1
2017-09-26 12:04:08 [15922] [6] DEBUG: SMPP[default_smsc]: Sending PDU:
2017-09-26 12:04:08 [15922] [6] DEBUG: SMPP PDU 0x7f2274025070 dump:
2017-09-26 12:04:08 [15922] [6] DEBUG:   type_name: submit_sm
2017-09-26 12:04:08 [15922] [6] DEBUG:   command_id: 4 = 0x00000004
2017-09-26 12:04:08 [15922] [6] DEBUG:   command_status: 0 = 0x00000000

```

```

2017-09-26 12:04:08 [15922] [6] DEBUG: sequence_number: 98163 = 0x00017f73
2017-09-26 12:04:08 [15922] [6] DEBUG: service_type: NULL
2017-09-26 12:04:08 [15922] [6] DEBUG: source_addr_ton: 5 = 0x00000005
2017-09-26 12:04:08 [15922] [6] DEBUG: source_addr_npi: 0 = 0x00000000
2017-09-26 12:04:08 [15922] [6] DEBUG: source_addr: "any"
2017-09-26 12:04:08 [15922] [6] DEBUG: dest_addr_ton: 1 = 0x00000001
2017-09-26 12:04:08 [15922] [6] DEBUG: dest_addr_npi: 1 = 0x00000001
2017-09-26 12:04:08 [15922] [6] DEBUG: destination_addr: "43676....."
2017-09-26 12:04:08 [15922] [6] DEBUG: esm_class: 3 = 0x00000003
2017-09-26 12:04:08 [15922] [6] DEBUG: protocol_id: 0 = 0x00000000
2017-09-26 12:04:08 [15922] [6] DEBUG: priority_flag: 0 = 0x00000000
2017-09-26 12:04:08 [15922] [6] DEBUG: schedule_delivery_time: NULL
2017-09-26 12:04:08 [15922] [6] DEBUG: validity_period: NULL
2017-09-26 12:04:08 [15922] [6] DEBUG: registered_delivery: 0 = 0x00000000
2017-09-26 12:04:08 [15922] [6] DEBUG: replace_if_present_flag: 0 = 0x00000000
2017-09-26 12:04:08 [15922] [6] DEBUG: data_coding: 0 = 0x00000000
2017-09-26 12:04:08 [15922] [6] DEBUG: sm_default_msg_id: 0 = 0x00000000
2017-09-26 12:04:08 [15922] [6] DEBUG: sm_length: 23 = 0x00000017
2017-09-26 12:04:08 [15922] [6] DEBUG: short_message:
2017-09-26 12:04:08 [15922] [6] DEBUG:   Octet string at 0x7f227400c460:
2017-09-26 12:04:08 [15922] [6] DEBUG:     len: 23
2017-09-26 12:04:08 [15922] [6] DEBUG:     size: 24
2017-09-26 12:04:08 [15922] [6] DEBUG:     immutable: 0
2017-09-26 12:04:08 [15922] [6] DEBUG:     data: 44 <14 bytes> 73
2017-09-26 12:04:08 [15922] [6] DEBUG:     data: 74 <5 bytes> 39
2017-09-26 12:04:08 [15922] [6] DEBUG:   Octet string dump ends.
2017-09-26 12:04:08 [15922] [6] DEBUG: SMPP PDU dump ends.
2017-09-26 12:04:08 [15922] [6] DEBUG: SMPP[default_smsc]: throughput (1.00,5.00)
...

```

– Example link enquiry:

```

...
2017-09-26 12:13:38 [15922] [6] DEBUG: SMPP[default_smsc]: throughput (0.00,5.00)
2017-09-26 12:13:38 [15922] [6] DEBUG: SMPP[default_smsc]: Got PDU:
2017-09-26 12:13:38 [15922] [6] DEBUG: SMPP PDU 0x7f2274020790 dump:
2017-09-26 12:13:38 [15922] [6] DEBUG:   type_name: enquire_link
2017-09-26 12:13:38 [15922] [6] DEBUG:   command_id: 21 = 0x00000015
2017-09-26 12:13:38 [15922] [6] DEBUG:   command_status: 0 = 0x00000000
2017-09-26 12:13:38 [15922] [6] DEBUG:   sequence_number: 90764 = 0x0001628c
2017-09-26 12:13:38 [15922] [6] DEBUG: SMPP PDU dump ends.
2017-09-26 12:13:38 [15922] [6] DEBUG: SMPP[default_smsc]: Sending PDU:
2017-09-26 12:13:38 [15922] [6] DEBUG: SMPP PDU 0x7f2274025070 dump:
2017-09-26 12:13:38 [15922] [6] DEBUG:   type_name: enquire_link_resp
2017-09-26 12:13:38 [15922] [6] DEBUG:   command_id: 2147483669 = 0x80000015
2017-09-26 12:13:38 [15922] [6] DEBUG:   command_status: 0 = 0x00000000
2017-09-26 12:13:38 [15922] [6] DEBUG:   sequence_number: 90764 = 0x0001628c

```

```
2017-09-26 12:13:38 [15922] [6] DEBUG: SMPP PDU dump ends.
2017-09-26 12:13:38 [15922] [6] DEBUG: SMPP[default_smsc]: throughput (0.00,5.00)
...
```

6.33.2.2 SMS Box (PRX node of NGCP)

On the PRX node you can see a **process** named "**smsbox**". This process has a **listening port** assigned to it: 13002, that is the communication port towards the *Bearer Box* component running on LB nodes.

The *ngcp-service* tool also shows the *smsbox* process in its summary information:

```
$ ngcp-service summary
Ok Service                               Managed   Started   Status
--  -----
...
kannel-smsbox                           managed   by-ha     active
...
```

The following log files can provide information about the operation of *SMS Box*:

- sent and received messages using the API of WEB node: `/var/log/kannel/smsbox.log`

Note

Sent and received message examples shown here do not contain the full phone number and content for confidentiality reason.

– Example sent message:

```
...
2017-09-26 12:16:42 [22763] [2] DEBUG: HTTP: Creating HTTPClient for '192.168.1.2'.
2017-09-26 12:16:42 [22763] [2] DEBUG: HTTP: Created HTTPClient area 0x7f5dcc000ad0.
2017-09-26 12:16:42 [22763] [3] INFO: smsbox: Got HTTP request </cgi-bin/sendsms> from ↔
<192.168.1.3>
2017-09-26 12:16:42 [22763] [3] INFO: sendsms used by <sipwise>
2017-09-26 12:16:42 [22763] [3] INFO: sendsms sender:<sipwise:43668.....> ↔
(192.168.1.3) to:<43676.....> msg:<...>
2017-09-26 12:16:42 [22763] [3] DEBUG: Stored UUID ab95eb45-1ec0-4932-9863-1a95609a025f
2017-09-26 12:16:42 [22763] [3] DEBUG: message length 52, sending 1 messages
2017-09-26 12:16:42 [22763] [3] DEBUG: Status: 202 Answer: <Sent.>
2017-09-26 12:16:42 [22763] [3] DEBUG: Delayed reply - wait for bearerbox
2017-09-26 12:16:42 [22763] [0] DEBUG: Got ACK (0) of ab95eb45-1ec0-4932-9863-1 ↔
a95609a025f
2017-09-26 12:16:42 [22763] [0] DEBUG: HTTP: Destroying HTTPClient area 0x7f5dcc000ad0.
2017-09-26 12:16:42 [22763] [0] DEBUG: HTTP: Destroying HTTPClient for '192.168.1.3'.
```

...

– Example received message:

...

```

2017-09-26 11:59:45 [22763] [5] INFO: Starting to service <...message content...> from ←
  <+43676-----> to <+43668----->
2017-09-26 11:59:45 [22763] [10] DEBUG: Queue contains 0 pending requests.
2017-09-26 11:59:45 [22763] [10] DEBUG: HTTPS URL; Using SSL for the connection
2017-09-26 11:59:45 [22763] [10] DEBUG: Parsing URL `https://192.168.1.2:1443/ ←
  internalsms/receive?auth_token=fNLosMgwdNUrKvEfFMm9
&timestamp=2017-09-26+09:59:45&from=%2B43676-----&to=%2B43668-----&charset=UTF-8& ←
  coding=0&text=...':
2017-09-26 11:59:45 [22763] [10] DEBUG:   Scheme: https://
2017-09-26 11:59:45 [22763] [10] DEBUG:   Host: 192.168.1.2
2017-09-26 11:59:45 [22763] [10] DEBUG:   Port: 1443
2017-09-26 11:59:45 [22763] [10] DEBUG:   Username: (null)
2017-09-26 11:59:45 [22763] [10] DEBUG:   Password: (null)
2017-09-26 11:59:45 [22763] [10] DEBUG:   Path: /internalsms/receive
2017-09-26 11:59:45 [22763] [10] DEBUG:   Query: auth_token=fNLosMgwdNUrKvEfFMm9& ←
  timestamp=2017-09-26+09:59:45&from=%2B43676-----
&to=%2B43668-----&charset=UTF-8&coding=0&text=...
2017-09-26 11:59:45 [22763] [10] DEBUG:   Fragment: (null)
2017-09-26 11:59:45 [22763] [10] DEBUG: Connecting nonblocking to <192.168.1.2>
2017-09-26 11:59:45 [22763] [10] DEBUG: HTTP: Opening connection to '192.168.1.2:1443' ( ←
  fd=31).
2017-09-26 11:59:45 [22763] [10] DEBUG: Socket connecting
2017-09-26 11:59:45 [22763] [9] DEBUG: Get info about connecting socket
2017-09-26 11:59:45 [22763] [9] DEBUG: HTTP: Sending request:
2017-09-26 11:59:45 [22763] [9] DEBUG: Octet string at 0x7f5dbc00f470:
2017-09-26 11:59:45 [22763] [9] DEBUG:   len:   382
2017-09-26 11:59:45 [22763] [9] DEBUG:   size: 1024
2017-09-26 11:59:45 [22763] [9] DEBUG:   immutable: 0
2017-09-26 11:59:45 [22763] [9] DEBUG:   data: 47 45 54 20 2f 69 6e 74 65 72 6e 61 6c 73 ←
  6d 73   GET /internalsms
2017-09-26 11:59:45 [22763] [9] DEBUG:   data: 2f 72 65 63 65 69 76 65 3f 61 75 74 68 5f ←
  74 6f   /receive?auth_to
2017-09-26 11:59:45 [22763] [9] DEBUG:   data: 6b 65 6e 3d ... ←
  ken=
  ... 20 48 54 54 50 2f 31 2e 31 ←
  0d 0a   HTTP/1.1..
2017-09-26 11:59:45 [22763] [9] DEBUG:   data: 43 6f 6e 6e 65 63 74 69 6f 6e 3a 20 6b 65 ←
  65 70   Connection: keep
2017-09-26 11:59:45 [22763] [9] DEBUG:   data: 2d 61 6c 69 76 65 0d 0a 55 73 65 72 2d 41 ←
  67 65   -alive..User-Age
2017-09-26 11:59:45 [22763] [9] DEBUG:   data: 6e 74 3a 20 4b 61 6e 6e 65 6c 2f 31 2e 34 ←
  2e 34   nt: Kannel/1.4.4

```

```
2017-09-26 11:59:45 [22763] [9] DEBUG: data: 0d 0a 48 6f 73 74 3a 20 31 39 32 2e 31 36 ←
      38 2e ..Host: 192.168.
2017-09-26 11:59:45 [22763] [9] DEBUG: data: 31 2e 32 3a 31 34 34 33 0d 0a 0d 0a ←
      1.2:1443....
2017-09-26 11:59:45 [22763] [9] DEBUG: Octet string dump ends.
2017-09-26 11:59:45 [22763] [9] DEBUG: HTTP: Status line: <HTTP/1.1 200 OK>
2017-09-26 11:59:45 [22763] [9] DEBUG: HTTP: Received response:
2017-09-26 11:59:45 [22763] [9] DEBUG: Octet string at 0x7f5dbc006970:
2017-09-26 11:59:45 [22763] [9] DEBUG: len: 333
2017-09-26 11:59:45 [22763] [9] DEBUG: size: 1024
2017-09-26 11:59:45 [22763] [9] DEBUG: immutable: 0
2017-09-26 11:59:45 [22763] [9] DEBUG: data: 53 65 72 76 65 72 3a 20 6e 67 69 6e 78 0d ←
      0a 44 Server: nginx..D
2017-09-26 11:59:45 [22763] [9] DEBUG: data: 61 74 65 3a 20 54 75 65 2c 20 32 36 20 53 ←
      65 70 ate: Tue, 26 Sep
2017-09-26 11:59:45 [22763] [9] DEBUG: data: 20 32 30 31 37 20 30 39 3a 35 39 3a 34 35 ←
      20 47 2017 09:59:45 G
2017-09-26 11:59:45 [22763] [9] DEBUG: data: 4d 54 0d 0a 43 6f 6e 74 65 6e 74 2d 54 79 ←
      70 65 MT..Content-Type
2017-09-26 11:59:45 [22763] [9] DEBUG: data: 3a 20 74 65 78 74 2f 68 74 6d 6c 3b 20 63 ←
      68 61 : text/html; cha
2017-09-26 11:59:45 [22763] [9] DEBUG: data: 72 73 65 74 3d 75 74 66 2d 38 0d 0a 43 6f ←
      6e 74 rset=utf-8..Cont
2017-09-26 11:59:45 [22763] [9] DEBUG: data: 65 6e 74 2d 4c 65 6e 67 74 68 3a 20 30 0d ←
      0a 43 ent-Length: 0..C
2017-09-26 11:59:45 [22763] [9] DEBUG: data: 6f 6e 6e 65 63 74 69 6f 6e 3a 20 6b 65 65 ←
      70 2d onnection: keep-
2017-09-26 11:59:45 [22763] [9] DEBUG: data: 61 6c 69 76 65 0d 0a 53 65 74 2d 43 6f 6f ←
      6b 69 alive..Set-Cooki
2017-09-26 11:59:45 [22763] [9] DEBUG: data: 65 3a 20 6e 67 63 70 5f 70 61 6e 65 6c 5f ←
      73 65 e: ngcp_panel_se
2017-09-26 11:59:45 [22763] [9] DEBUG: data: 73 73 69 6f 6e 3d 34 35 30 32 64 64 66 65 ←
      31 62 ssion=4502ddfelb
2017-09-26 11:59:45 [22763] [9] DEBUG: data: 63 31 65 33 39 30 65 30 64 36 66 39 64 34 ←
      37 30 c1e390e0d6f9d470
2017-09-26 11:59:45 [22763] [9] DEBUG: data: 35 30 37 62 64 64 33 61 65 32 36 62 64 63 ←
      3b 20 507bdd3ae26bdc;
2017-09-26 11:59:45 [22763] [9] DEBUG: data: 70 61 74 68 3d 2f 3b 20 65 78 70 69 72 65 ←
      73 3d path=/; expires=
2017-09-26 11:59:45 [22763] [9] DEBUG: data: 54 75 65 2c 20 32 36 2d 53 65 70 2d 32 30 ←
      31 37 Tue, 26-Sep-2017
2017-09-26 11:59:45 [22763] [9] DEBUG: data: 20 31 30 3a 35 39 3a 34 35 20 47 4d 54 3b ←
      20 48 10:59:45 GMT; H
2017-09-26 11:59:45 [22763] [9] DEBUG: data: 74 74 70 4f 6e 6c 79 0d 0a 58 2d 43 61 74 ←
      61 6c ttpOnly..X-Catal
2017-09-26 11:59:45 [22763] [9] DEBUG: data: 79 73 74 3a 20 35 2e 39 30 30 37 35 0d 0a ←
      53 74 yst: 5.90075..St
2017-09-26 11:59:45 [22763] [9] DEBUG: data: 72 69 63 74 2d 54 72 61 6e 73 70 6f 72 74 ←
```

```

    2d 53    rict-Transport-S
2017-09-26 11:59:45 [22763] [9] DEBUG:   data: 65 63 75 72 69 74 79 3a 20 6d 61 78 2d 61 ↔
    67 65    ecurity: max-age
2017-09-26 11:59:45 [22763] [9] DEBUG:   data: 3d 31 35 37 36 38 30 30 30 0d 0a 0d 0a ↔
    =15768000....
2017-09-26 11:59:45 [22763] [9] DEBUG: Octet string dump ends.
2017-09-26 11:59:45 [22763] [6] WARNING: Tried to set Coding field, denied.
2017-09-26 11:59:45 [22763] [6] INFO: No reply sent, denied.
2017-09-26 11:59:55 [22763] [9] DEBUG: HTTP: Server closed connection, destroying it ↔
    <192.168.1.2:1443:1::><0x7f5db000b20><fd:31>.
...

```

- short log of sent/received messages: `/var/log/kannel/smsbox-access.log`

```

...
2017-09-26 12:39:18 SMS HTTP-request sender:+43680----- request: '' url: 'https ↔
    ://192.168.1.2:1443/internalsms/receive?
auth_token=fNLosMgwdNUrKvEfFMm9&timestamp=2017-09-26+10:39:18&from=%2B43680-----&to=%2 ↔
    B43668-----&charset=UTF-8&coding=0
&text=<...message content...>' reply: 200 '<< successful >>'
...
2017-09-26 12:41:54 send-SMS request added - sender:sipwise:43668----- 192.168.1.3 ↔
    target:43680----- request: '<...message content...>'
...

```

6.33.3 REST API

Handling of short messages from the user perspective happens with the help of NGCP's REST API. There is a dedicated resource: `https://<IP of WEB node>:1443/api/sms` that allows you to:

- **Get a list of sent and received messages.** This is achieved by sending a GET request on the `/api/sms` collection, as in the following example:

```

curl -i -X GET -H 'Connection: close' --cert NGCP-API-client-certificate.pem \
    --cacert ca-cert.pem 'https://example.org:1443/api/sms/?page=1&rows=10'

```

- **Retrieve an SM** (both sent and received). This is achieved by sending a GET request for a specific `/api/sms/id` item, as in the following example:

```

curl -i -X GET -H 'Connection: close' --cert NGCP-API-client-certificate.pem \
    --cacert ca-cert.pem 'https://example.org:1443/api/sms/1'

```

- **Send a new message** from a local subscriber. This is achieved by sending a POST request for the `/api/sms` collection, as in the following example:

```
curl -i -X POST -H 'Connection: close' -H 'Content-Type: application/json' \
  --cert NGCP-API-client-certificate.pem --cacert ca-cert.pem \
  'https://example.org:1443/api/sms/' --data-binary '{"callee" : "43555666777", \
  "subscriber_id" : 4, "text" : "test"}'
```

As always, the full documentation of the REST API resources is available on the admin web interface of NGCP: `https://<IP of WEB node>:1443/api/#sms`

6.34 Time sets management

6.34.1 Time sets specifications and data description

The Sipwise C5 provides administrative WEB and API interface to manage time sets.

Supported fields, input and output format are based on **iCalendar EVENT** specification.

Not all iCalendar and EVENT properties are supported, but those that are used for time points and periods definition or stated mandatory by specification:

- CALENDAR supported properties:

- NAME

- EVENT supported properties:

- SUMMARY

- DTSTART

- DTEND

- RRULE

Important to mention that current implementation does not support these EVENT properties:

- DTSTAMP (UID is used in generated calendar ics file, both UID and DTSTAMP are ignored during uploading calendar file);
- DURATION (DTEND is used);
- RDATE
- EXDATE
- PRIORITY

Main EVENT property, that is used for time points and periods definition is RRULE. Current time sets implementation supports all properties described in the [RRULE specification](#) except WKST.

Default value for week start is MO (Monday).

6.34.2 Web interface for the time sets

Time sets management section is provided in two variants. One is main time sets management section and other is a chapter on reseller details page. Variants have minor differences. Functionality will be explained using time sets dedicated interface. Differences will be explained below.

Time set can be created using creation form. On time sets management interface press button "Create Time Set Entry":

The screenshot shows the Sipwise NGCP Dashboard interface. At the top, there is a navigation bar with the logo and the text "sip:WISE NGCP Dashboard". To the right of the logo are several menu items: "Documentation", "Monitoring & Statistics", "Tools", and "Settings". Below the navigation bar, the main content area is titled "Time Set".

In the "Time Set" section, there are two buttons: "← Back" and "★ Create Time Set Entry". The "Create Time Set Entry" button is highlighted with a red rectangular box. Below the buttons, there is a "Show" dropdown menu set to "5" and a "Search:" input field. Below these elements is a table with the following data:

#	Reseller	Name
1	api_test test reseller	test2

Below the table, it says "Showing 1 to 1 of 1 entries" and there are pagination controls showing "1" in a highlighted box.

At the bottom of the dashboard, there is a footer with the text "trunk © 2013 - 2019 Sipwise GmbH, all rights reserved."

"Reseller" field is mandatory.

"Name" field should be defined, if iCalendar (ics) file is not going to be uploaded or file doesn't have NAME property for the CALENDAR entry.

If both NAME in the uploaded iCalendar (ics) file and form field "Name" aren't empty then value from the form field will be taken.

Created time set can be modified:

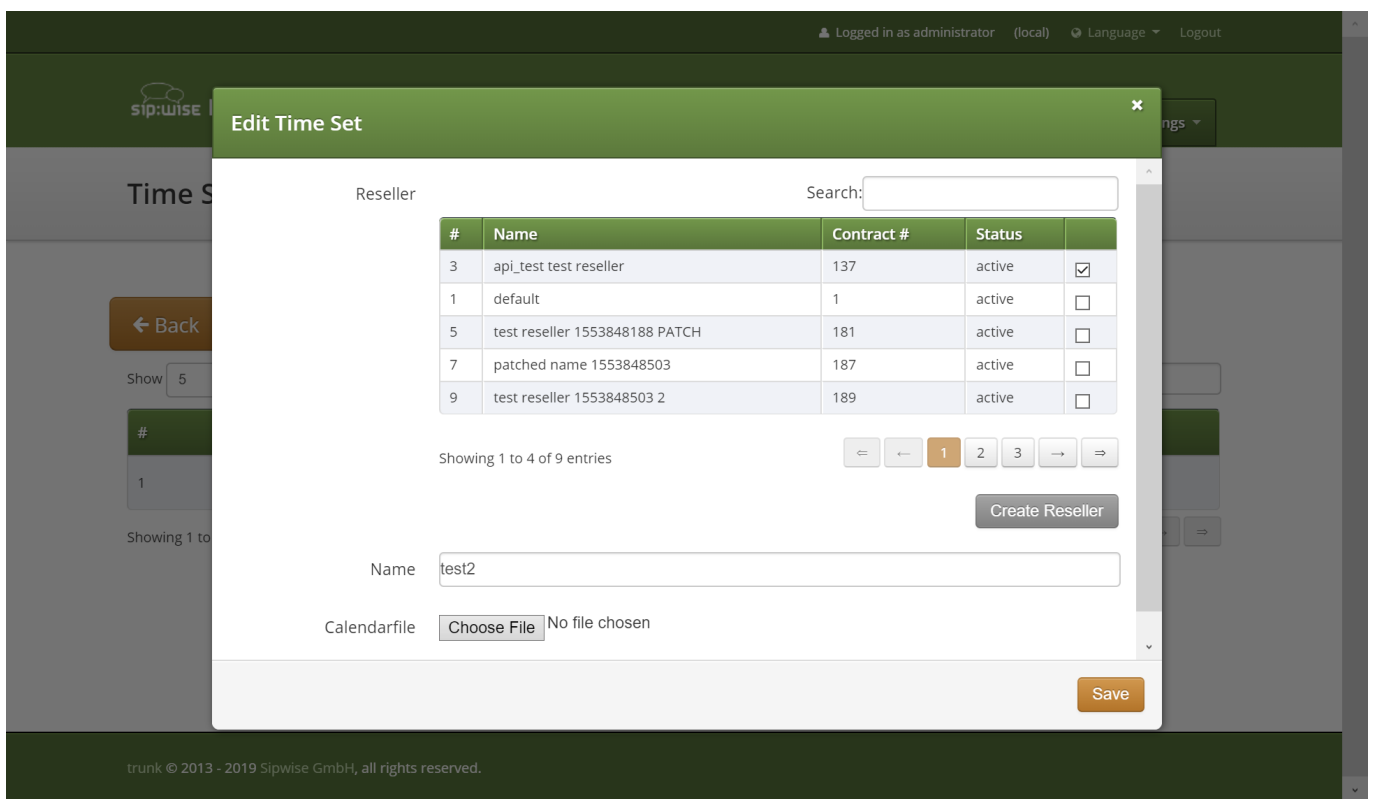
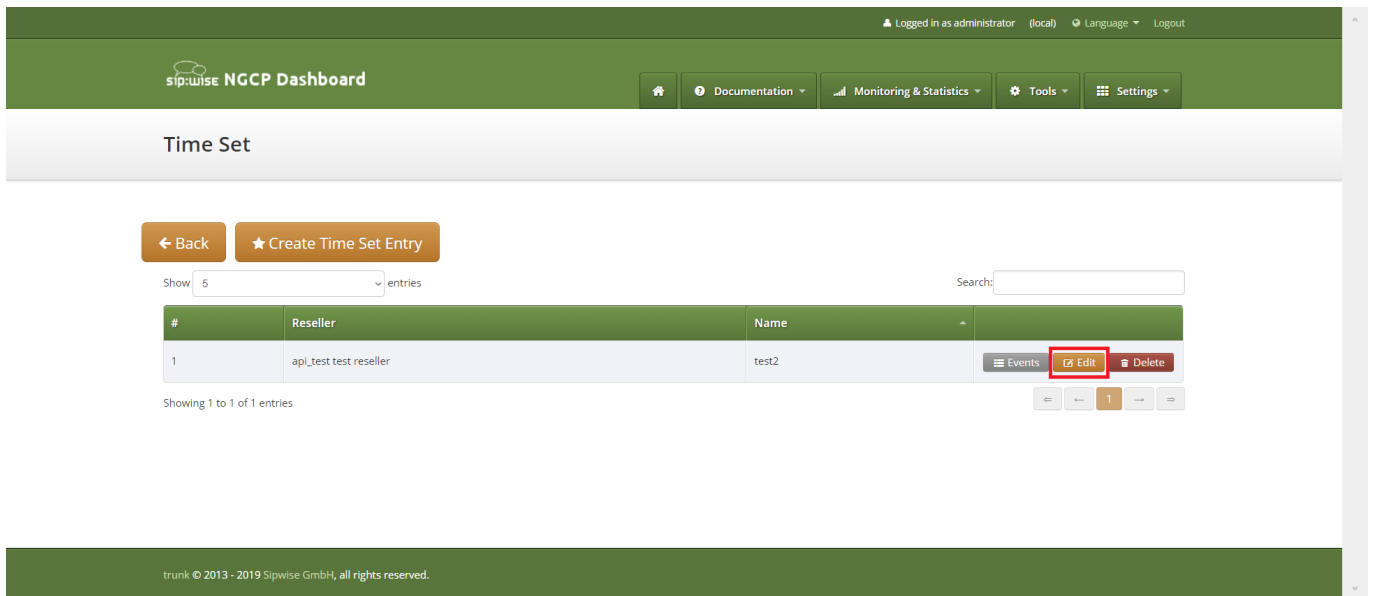

or deleted:

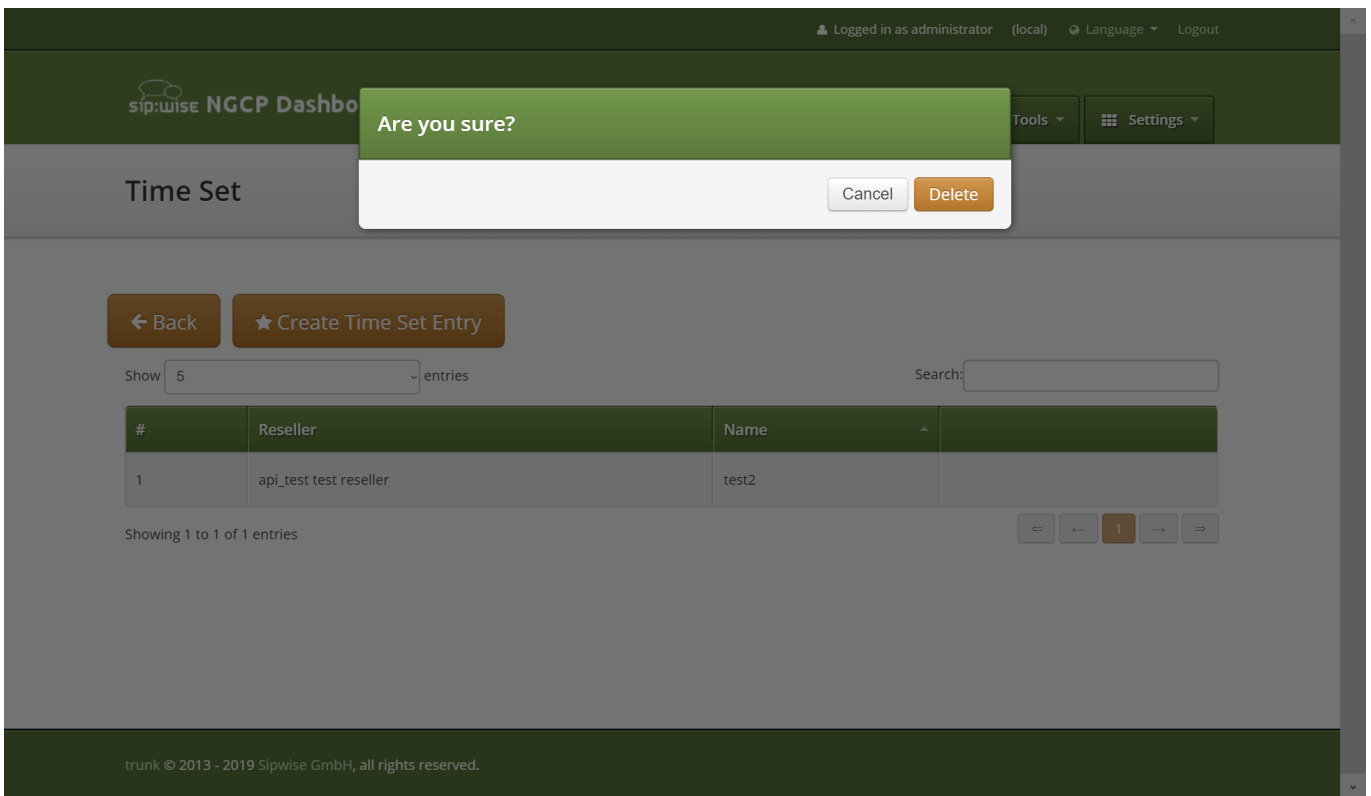
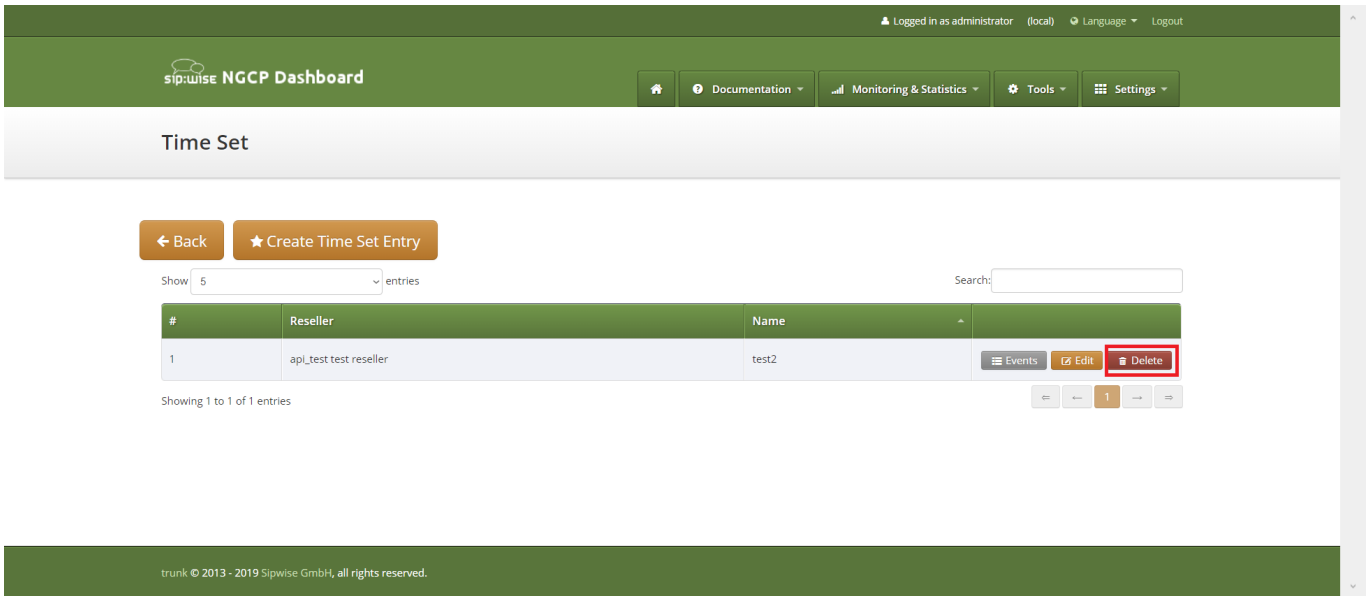

Note

If calendar ics file will be uploaded to edit time set, all presented events will be deleted and events from the uploaded file will be added after it.

6.34.3 Web interface for the time set events

Time set can contain set of events. Each time set event will be used to generate CALENDAR EVENT entry in the generated iCalendar file. So all fields in the time set event forms represent properties of the iCalendar EVENT component.

To manage time set events press "Events" button against proper time set.

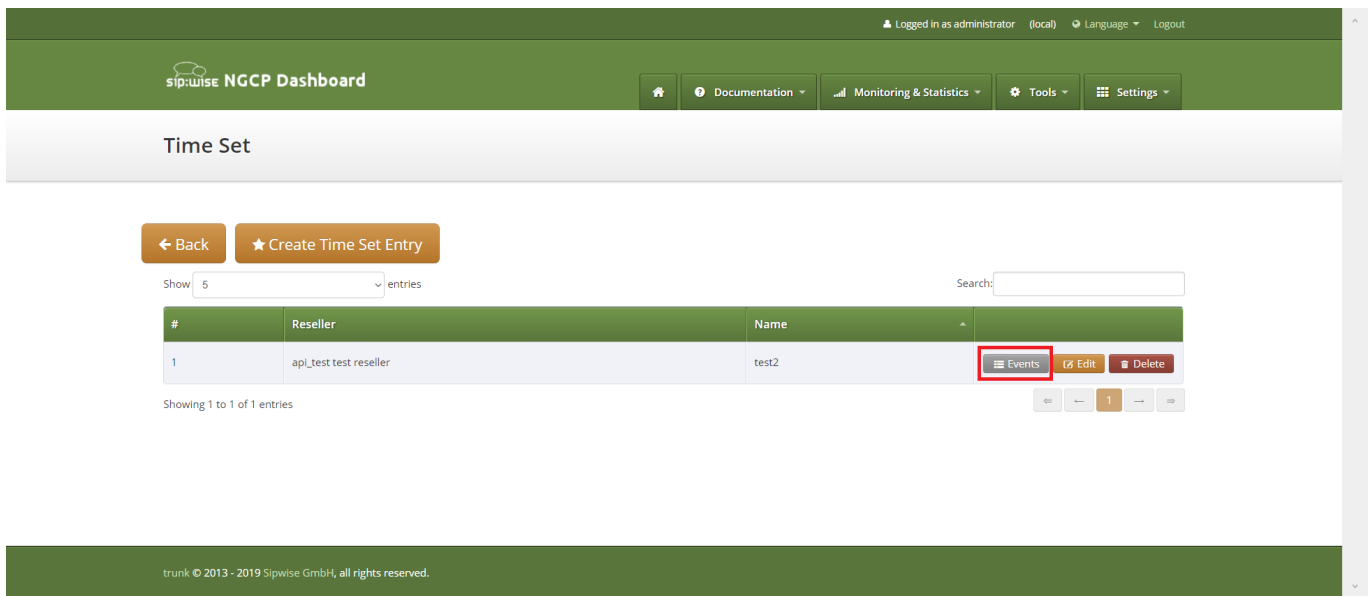

Events management section will appear:

To create event press "Create Event" button.

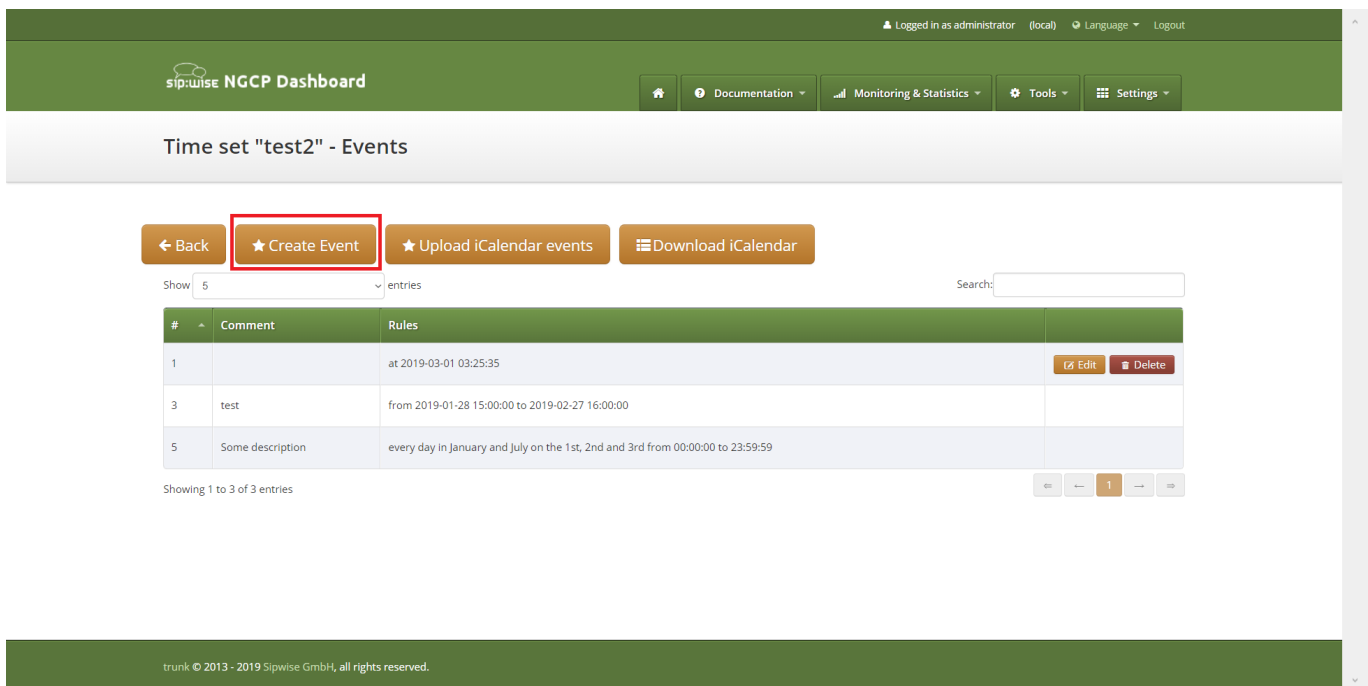

Form to create event will be shown:

Logged in as administrator (local) Language Logout

sip:wise NCCB Dashboard

Create Time Set Event

Comment

Start Date Time

Stop

Repeat

← Back

Show 5

#		
1		
3	test	from 2019-01-28 15:00:00 to 2019-02-27 16:00:00

Showing 1 to 2 of 2 entries

trunk © 2013 - 2019 Sipwise GmbH, all rights reserved.

6.34.3.1 Time set event form fields explanation

"Start" field reflects DTSTART property of the EVENT. "Start" is mandatory and by default is set to the start of the current day. "Start" value format is datetime.

"Stop" field reflects DTEND property of the EVENT. For the events within recurrence "Stop" will define duration of each iteration.

To specify "Stop" datetime, press button "Set".

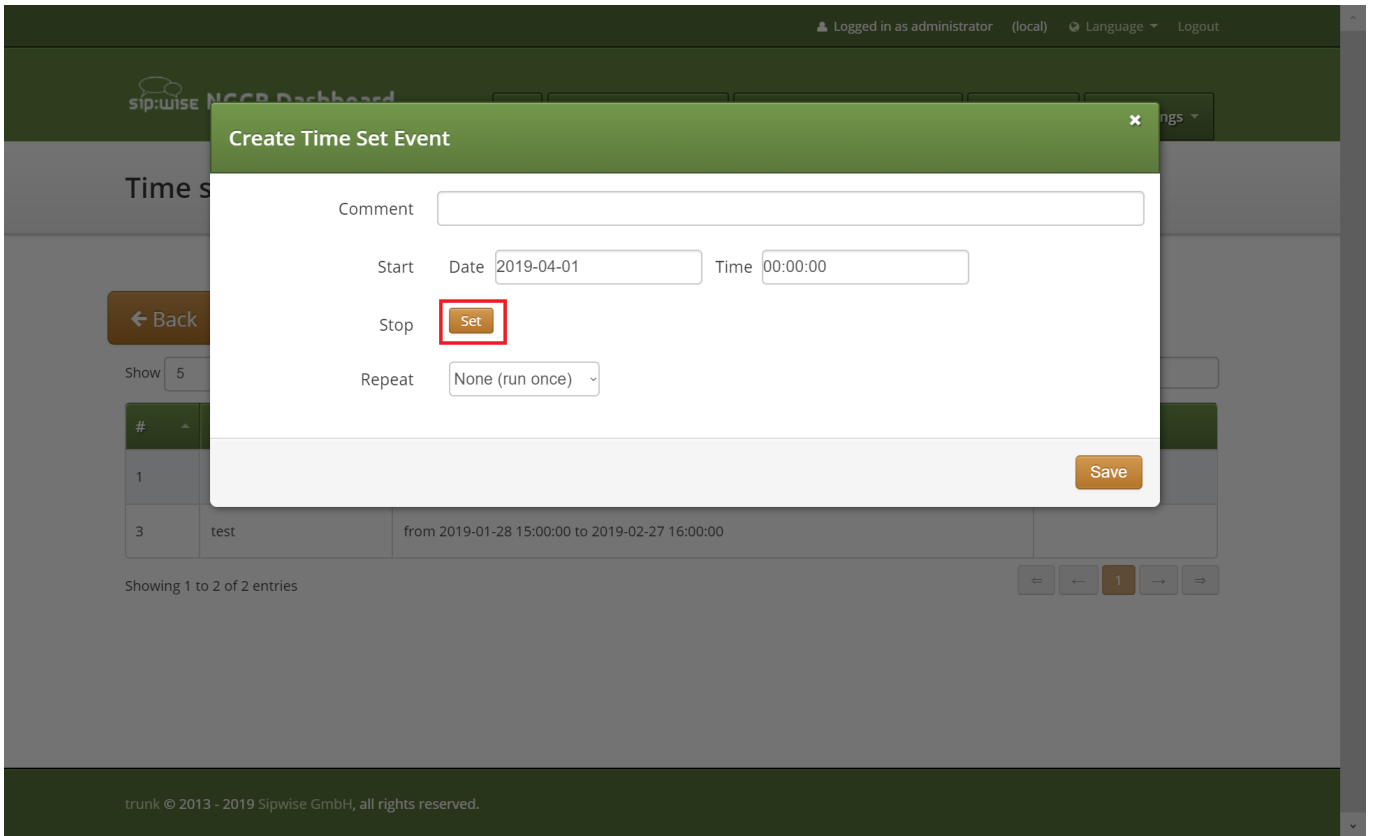

Fields to enter DTEND date and time will appear:

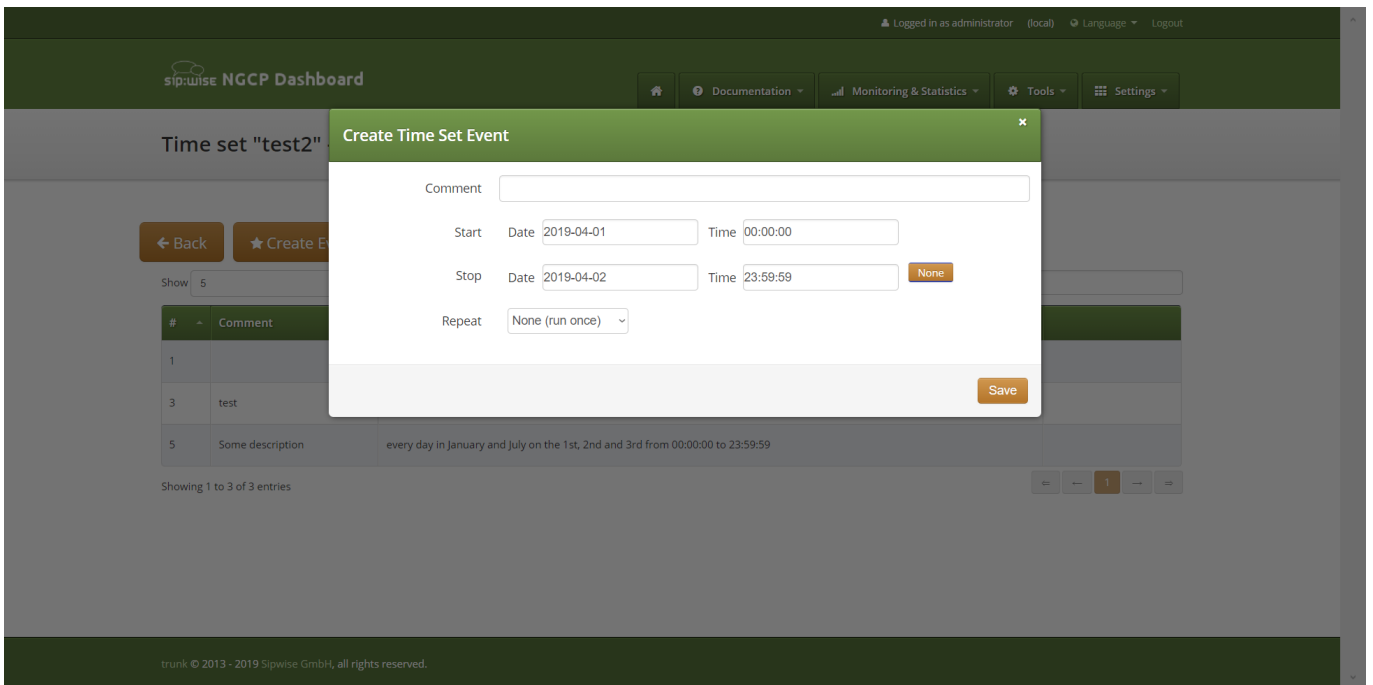

To return "Stop" field to the empty value press button "None". Value in the form fields will be preserved, but newly created EVENT will have empty DTEND property.

Other fields in the form are optional. Most of them aren't visible by default and will be shown if requested by user or required by

data into other fields.

RRULE property of the EVENT is a recurrence rule and defines set of the iterations for the EVENT.

To customize recurrence rule for the EVENT select proper repetition unit for the "Repeat" form field. Input field for the recurrence interval will appear left to the frequency select.

According to the selected unit, FREQ property of the EVENT RRULE will be set to one of the: SECONDLY, MINUTELY, HOURLY, DAILY, WEEKLY, MONTHLY, YEARLY.

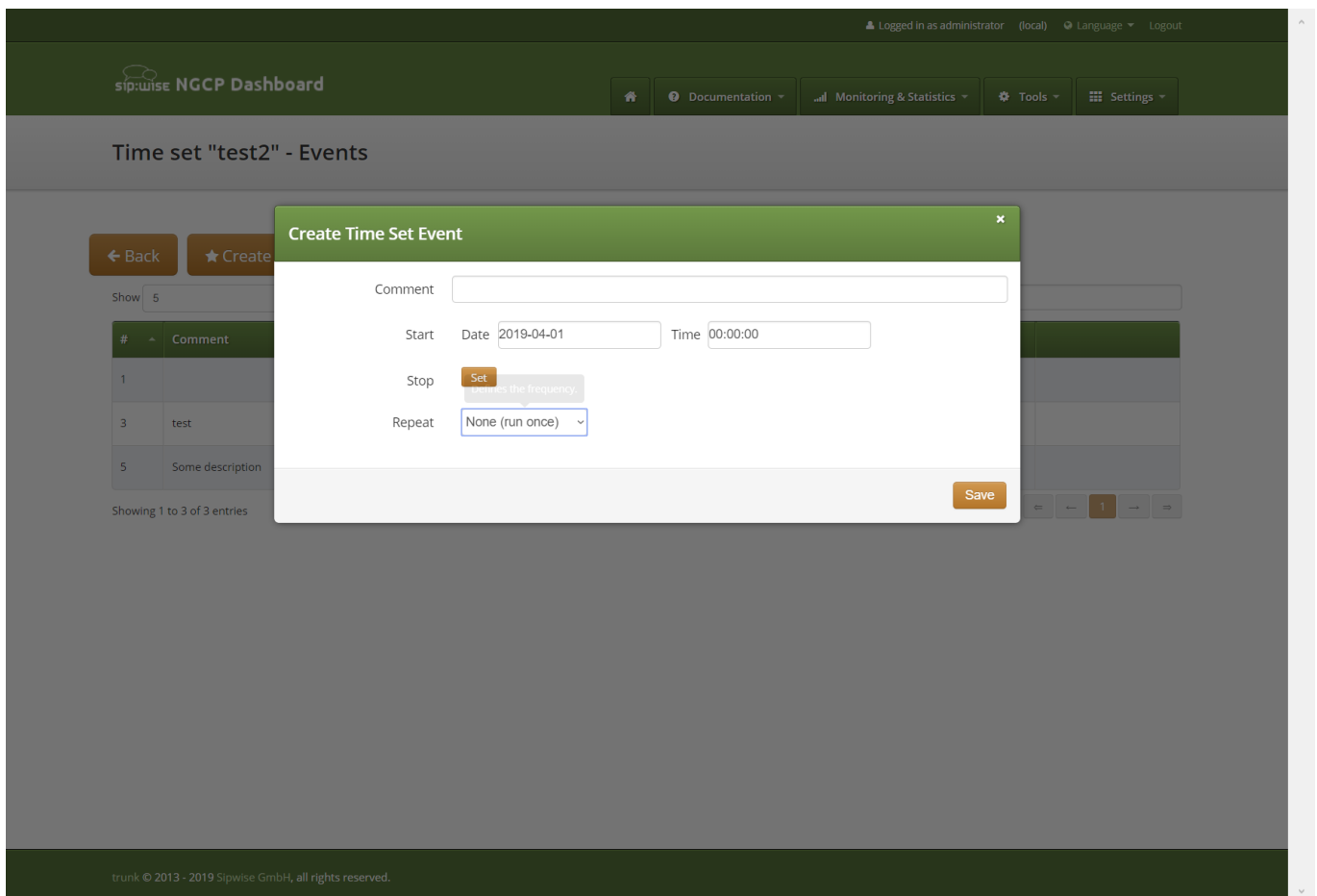

The screenshot displays the Sipwise NGCP Dashboard interface. At the top, it shows the user is logged in as an administrator. The main navigation bar includes links for Documentation, Monitoring & Statistics, Tools, and Settings. The current page is titled "Time set 'test2' - Events". A modal dialog box titled "Create Time Set Event" is open, allowing the user to configure a new event. The dialog contains the following fields:

- Comment:** An empty text input field.
- Start:** A date field set to "2019-04-01" and a time field set to "00:00:00".
- Stop:** A dropdown menu with the option "Set as the frequency" selected.
- Repeat:** A dropdown menu with the option "None (run once)" selected.

A "Save" button is located at the bottom right of the dialog box. In the background, a table of events is visible, showing columns for "#", "Comment", and "Showing 1 to 3 of 3 entries".

To specify end of the EVENT iterations, select "Series stop" value. For the "at date" option will be shown input for the date and time that will define UNTIL property of the EVENT RRULE.

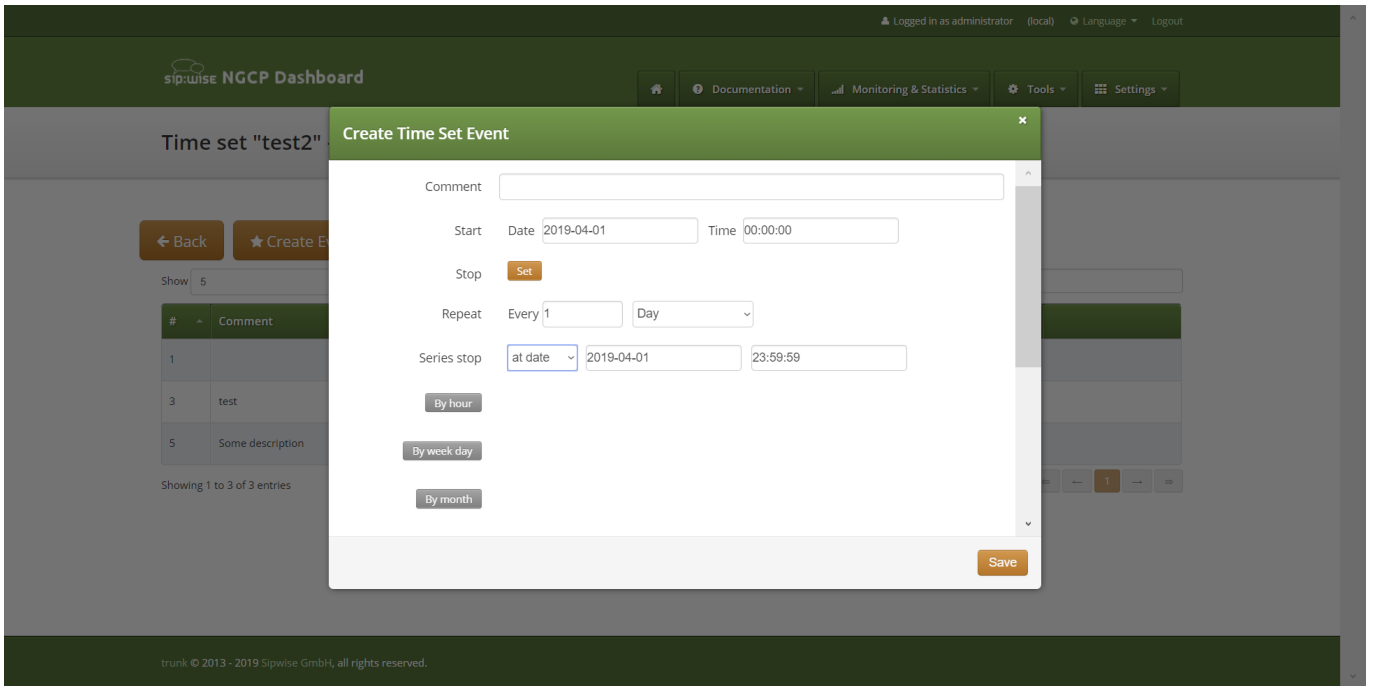

"after" option, respectively, will put entered value to the COUNT property of the EVENT RRULE.

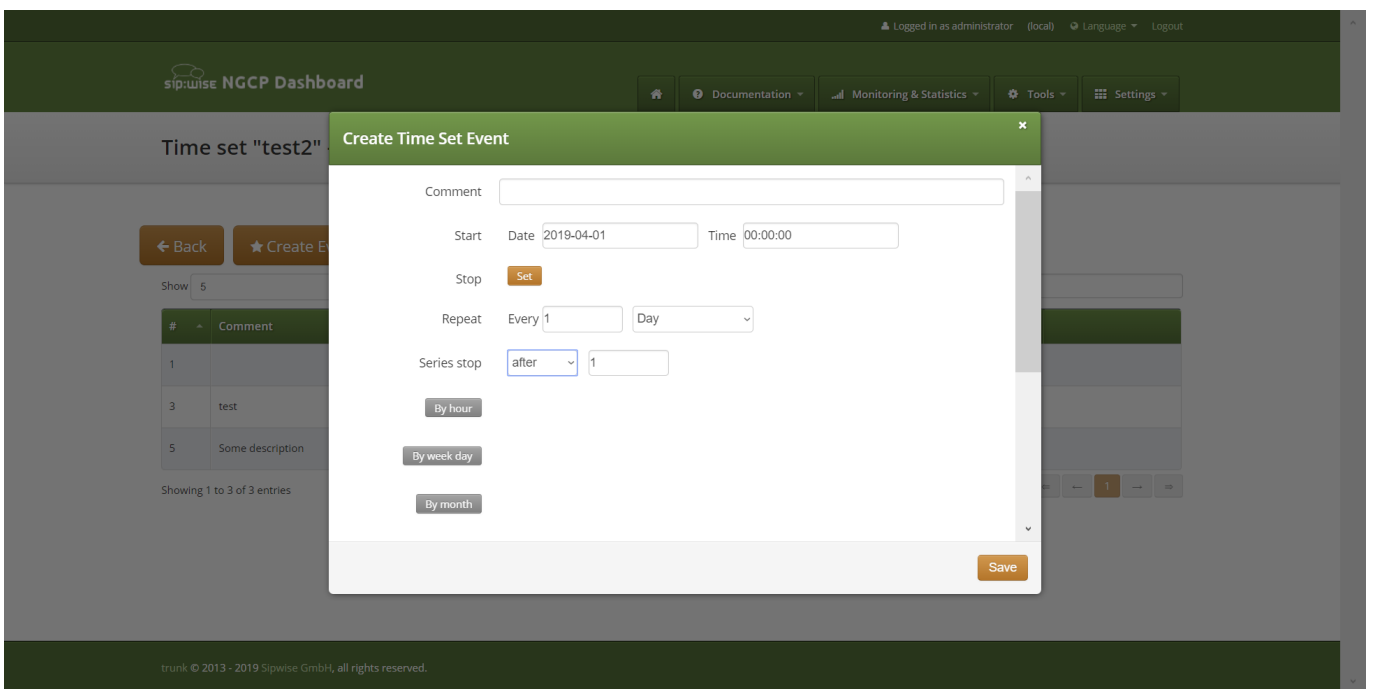

Form fields "By hour", "By week day", "By month", "By month day", "By set position", "By week number", "By year day", "By second" and "By minute" aren't shown by default. To enter value to any of these fields press according button on the left. Button with field name is grayed off when corresponding EVENT property is empty.

The screenshot shows the 'Create Time Set Event' dialog box in the Sipwise NGCP Dashboard. The dialog box is titled 'Create Time Set Event' and has a close button (X) in the top right corner. It contains the following fields and controls:

- Comment:** A text input field.
- Start:** A date input field with the value '2019-04-01' and a time input field with the value '00:00:00'.
- Stop:** A button labeled 'Set'.
- Repeat:** A label 'Repeat' followed by 'Every' and a numeric input field with the value '1', and a dropdown menu with the value 'Day'. A tooltip 'Defines the frequency.' is visible above the dropdown.
- Series stop:** A dropdown menu with the value 'never'.
- Frequency Selection:** Three buttons: 'By hour', 'By week day', and 'By month'. The 'By week day' button is highlighted in orange, indicating it is the selected frequency.
- Save:** A button at the bottom right of the dialog box.

The background page shows a table of events for the time set 'test2'. The table has columns for '#', 'Comment', and 'Series stop'. The first three rows are visible:

#	Comment	Series stop
1		
3	test	
5	Some description	

Showing 1 to 3 of 3 entries

When gray button with field name is pressed, field input control appears on the right. In the same time button with field name becomes orange, indicating that field value will be saved for the EVENT.

Fields with checkboxes controls have auxiliary button "Invert selection". When button "Invert selection" is pressed currently empty checkboxes become selected and currently selected checkboxes become empty.

The screenshot shows a 'Create Time Set Event' modal window. The 'Comment' field contains 'Some description'. The 'Start' date is '2019-04-01' and time is '00:00:00'. The 'Stop' date is '2019-04-01' and time is '23:59:59'. The 'Repeat' field is set to 'Every 1 Day'. The 'Series stop' is set to 'never'. Under the 'By hour' section, checkboxes for hours 0 through 23 are displayed. The 'Invert selection' and 'Clear' buttons are highlighted with a red box. A 'By week day' button is located below the hour checkboxes. A 'Save' button is at the bottom right of the modal.

When form data will be saved, checkboxes values will be saved as coma separated numbers.

BYxxx RRULE properties expand or limit behavior of the FREQ according to the table in the [RRULE specification](#).

Field "By week day" has two variants of the input: checkbox for each week day and text input. Text input can be used, if "By week day" value is more complex than just list of week days, separated by coma, for example for FREQ MONTHLY value "2TH,-3FR" in the "By week day" will mean second Thursday from the month start and third Friday from the month end in every month. Such value can't be presented as checkboxes selection.

Fields "By set position" and "By year day" are text inputs. Value format for these fields is set of the [+/-]NUMBER values, separated by comma.

For the "By year day" minus sign in front of year day number means that this day should be taken by number from the end of the year.

For the "By set position" minus sign in front of the position of the iteration means that the iteration should be taken by number from the end of the generated iterations sequence.

After new event created, event will appear in time set event list. It will have column with rrule text description, buttons to request event edit form or event deletion.

In events list section all events can be redefined uploading ics iCalendar file:

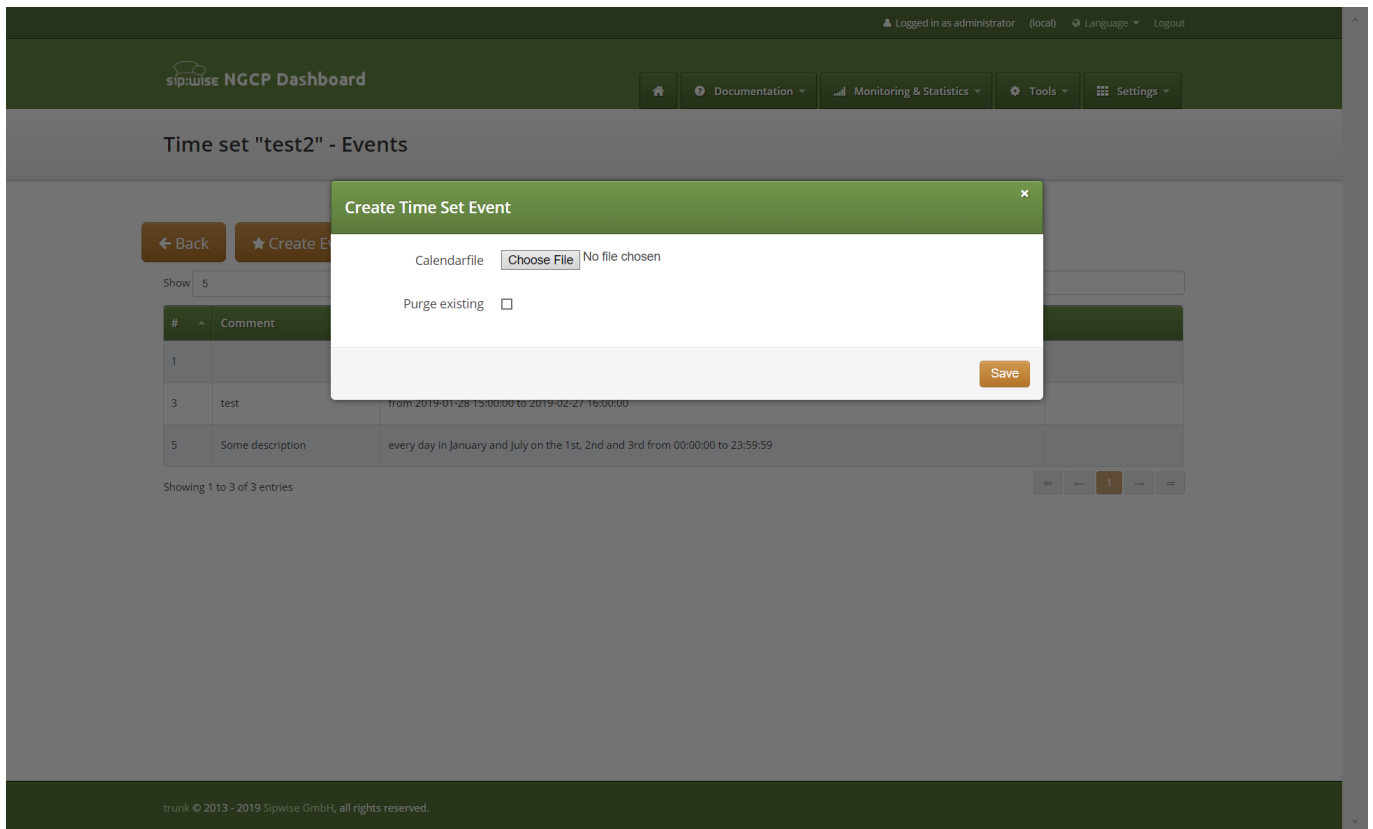

If "Purge existing" option is selected, all existing time set events will be removed before creation of the events from the uploaded file.

To download iCalendar ics file of the time set, press "Download iCalendar".

6.34.4 Web interface for time set related to reseller

Reseller details page provides list of the time sets connected to the reseller and allows create, edit, delete and download time set and has link to the time set events section:

Reseller Details for api_test test reseller

← Back Preferences Expand Groups

Reseller Base Information

Reseller Contract

Reseller Contact

Administrator Logins

Domains

Billing Profiles

Billing Networks

Profile Packages

Customers

Branding

Invoice Templates

Phonebook

Time sets

★ Create Time Set

Show 5 entries Search:

#	Name	Events	Download	Edit	Delete
1	test2				

Showing 1 to 1 of 1 entries

trunk © 2013 - 2019 Sipwise GmbH, all rights reserved.

In difference to the main time set interface, iCalendar ics file for the time set can be downloaded from the time set list pressing "Download" button.

Creation form doesn't have "Reseller" field and is processed in context of the current reseller.

6.34.5 REST API

Time sets management is possible using API REST entry point `/api/timesets/`.

Time sets API has possibility to get and return information both as "application/json" data and as "text/calendar" file.

To create time set with events full specification of the all fields in json format can be used:

```
curl --request POST --user administrator:administrator --header Prefer: return=representation --header Content-Type: application/json https://127.0.0.1:1443/api/timesets/ --data {"reseller": "api_test", "name": "api_test_timeset_name1", "times": [{"start": "1971-01-01 00:00:01", "until": "1997-01-01 00:00:01"}]}
```

```
23:59:59", "end": "2020-12-31 23:59:59"]}]}
```

Also time set and events can be uploaded as ics iCalendar file:

```
curl --request POST --user administrator:administrator --header Prefer: return=representation
--header Content-Type: multipart/form-data https://127.0.0.1:1443/api/timesets/ --form
json={"reseller_id":3, "name": "unique_name"} --form calendarfile=@/path/to/calendar.ics
```

Output of the GET request to the time set item can be text/calendar:

```
curl --request GET --user administrator:administrator --header Accept: text/calendar http
\> /path/to/download/calendar.ics
```

or application/json:

```
curl --request GET --user administrator:administrator --header Accept: application/json
https://127.0.0.1:1443/api/timesets/12
```

By default API will send response in text/calendar format.

Output will be generated iCalendar including time set events:

```
curl --request GET --user administrator:administrator 'https://127.0.0.1:1443/api/timesets ←
/12'
BEGIN:VCALENDAR
PRODID:--//Mozilla.org/ONSGML Mozilla Calendar V1.1//EN
NAME:api_test_timeset_name2
VERSION:2.0

BEGIN:VEVENT
UID:sipwise19@sipwise15
SUMMARY:unique_name event 19
DTSTART:19710101T000001
DTEND:20201231T235959
END:VEVENT
END:VCALENDAR+
```

6.35 Generation of 181 Call Is Being Forwarded

6.35.1 Overview

SIP message *181 - Call Is Being Forwarded* is an optional provisional response that can be sent towards the caller user to inform it of an ongoing call forward. The message can also contain History-Info headers necessary to the caller to identify which is the new destination of the call.

6.35.2 How to enable it

By default Sipwise C5 doesn't generate any 181 message. To enable this feature two steps are required:

- set config.yml option `kamailio.proxy.cf_send_181.enable` to `yes`
- set config.yml option `sems.sbc.reset_tag_on_fork` to `yes`

The first preference will actually activate the 181 message generation. The second one, instead, allows SEMS to forward back to caller all the provisional messages even if they contain a different To-Tag. Without this second preference set, the 181 message is sent towards the caller but all the following 18x messages are blocked by SEMS.

Additionally to add the History-Info headers to the 181 message:

- the option `outbound_history_info` has to be set in subscriber/domain preferences

6.35.3 How it works

When a call forward is triggered in Sipwise C5, Kamailio Proxy stores in the Redis database, which is selected by `kamailio.proxy.cf_send_181` preference in config.yml, the History-Info headers that are added to the outgoing INVITE message. Kamailio LB receives the outgoing INVITE and it generates a `182 - Connecting` message back towards the caller. The 182 message is received by Kamailio Proxy that converts it in a `181 - Call Is Being Forwarded` message and adds the History-Info headers previously stored in the Redis DB, if any. The message is then sent back to the caller.

6.36 Header Manipulations

6.36.1 Overview

Header Manipulations feature enables a flexible way to modify headers of SIP messages when it is being processed by the SIP proxy. That helps with scenarios where based on specific header conditions, certain header changes must take place (e.g.: If "From" does not match expected number or a format and there is no Diversion header then the P-Asserted-Identity header must be modified (or added) with the current subscriber's network provided CLI number). Another example is when there is a faulty User-Agent sending a malformed Contact entry then, based on the User-Agent header value and Contact header format, it is becomes possible to detect such scenario, and fix the Contact header on the fly without directly modifying the proxy logic.

Header Manipulations (also called in the UI/API as **Header Rules**) consist of:

- **Sets** - belong to a reseller, contain **Rules** and can be assigned to `Domains`, `Subscribers` and `Peer Hosts`.
- **Rules** - belong to **Sets** and contains **Conditions** and **Actions**
- **Conditions** - contain header expressions to be evaluated, if any **Condition** returns `False` then the whole **Rule** is immediately ignored.
- **Actions** - contain actions that are applied to the headers if all **Conditions** of the **Rule** are evaluated as `True`

6.36.2 Sets

Set is a topmost level entry and used in `Domain / Peer / Subscriber` based header manipulation scenarios. Only one Set can be assigned per `Domain / Peer / Subscriber` but the same Set can be assigned to any of them simultaneously.

- `Reseller` (for platform administrators): `reseller_id` the Set belongs to
- `Name`: Set name
- `Description`: custom description

6.36.3 Rules

Rule should have at least one Condition and Action to be taken into account. All Conditions of the Rule must match, otherwise the Rule is skipped.

- `Name`: Rule name
- `Description`: custom description
- `Priority`: a number that defines priority of the Rule. Smaller numbers have higher priority. All Rules within the same Set are evaluated by priority and as such it is important to have them ordered as expected
- `Direction`: defines when the Rule is used
 - `Inbound`: applied when a SIP message is received by the proxy from the load balanced, the Set to be applied is picked from the `caller` preferences
 - `Outbound`: applied when a SIP message is about to leave the proxy, where Set to be applied is picked from the `callee` preferences
 - `Local`: applied when a SIP message is going to be routed to a local, where Set to be applied is picked from the `caller` preferences
 - `Peer`: applied when a SIP message is going to be routed to a peering, where Set to be applied is picked from the `caller` preferences
 - `Call Forward Inbound`: applied when a SIP message is coming via the call forwarding, where Set to be applied is picked from the `caller` preferences
 - `Call Forward Outbound`: applied when a call forwarding is triggered, where Set to be applied is picked from the `callee` preferences
 - `Reply`: applied when a SIP reply message is received by the proxy, where Set to be applied is picked from the `caller` preferences
- `Stopper`: can be either `True` or `False`. When set to `True` and the Rule is successful then no further Rules are processed within the given Set
- `Enabled`: can be either `True` or `False` and defines whether to include the Rule into processing within the given Set

6.36.4 Conditions

Condition contains one or many header validation expressions. Conditions do not modify any header data, only evaluate it. Conditions also operate with internal proxy runtime variables (`$avp`, `$xavp`) and they can be used to compare for instance a header value with an `$avp` value (those are for expert use only).

- **Match:** what to evaluate
 - `header`: header value
 - `preference`: subscriber or peering preference
 - `avp`: `$avp` variable
- **Part:** if the header (or `$avp`) value is a SIP-URI then it is possible to pick which part of it should be taken for the evaluation:
 - `full`: the entire value
 - `username`: SIP username
 - `domain`: SIP domain
 - `port`: SIP port
- **Name:** header or `$avp` name
- **Expression:** expression that is used to compare the extracted value
 - `is`: strict string comparison
 - `contains`: if the value contains the matching part
 - `matches`: same as `contains` but also accepts `*` to be used as none to many characters and `?` as any single character
 - `regex`: a regular expression
- **Not:** if set to `True` then the Condition returns `True` if the evaluation fails
- **Type:** user value type
 - `input`: raw string
 - `preference`: preference name, in this case the value(s) is taken from the preference. If the preference contains more than one value then all of them are evaluated until first match
 - `avp`: `$avp` name, in this case the value(s) is taken from the `$avp`. If the `$avp` contains more than one value then all of them are evaluated until first match
- **Value:** one or many values, **NOTE:** supports inline `$avp` transformations, e.g: if `$avp(s:source_cli) = 456` then `123$avp(s:source_cli)789` is evaluated as `123456789`
- **Enabled:** skipped if set to `False`
- **Rewrite Rule Set:** if the header value needs to be normalised before evaluation then an existing Rewrite Rule Set can be used for that, it is mandatory to select a header rules part when the option is used
- **Rewrite Rule:** Rewrite Rules to use from the selected Rewrite Rule Set

- Inbound for Caller
- Inbound for Callee
- Outbound for Caller
- Outbound for Callee

6.36.5 Actions

Action contains one or many changes that are applied to headers if the Rule is successful, it is also possible to modify the internal proxy \$avp runtime values (expert use only). Unlike Conditions, all Actions are applied regardless if some cannot be applied (e.g.: a header to remove does not exist).

- **Priority:** a number that defines priority of the Action. Smaller numbers have higher priority. The order is important when for instance you copy data between headers or need to add a header if it does not exist yet
- **Header:** header or \$avp name to apply actions to
- **Header Part:** if the header (or \$avp) value is a SIP-URI then it is possible to pick which part of the value needs to be changed
 - **full:** the entire value
 - **username:** SIP username
 - **domain:** SIP domain
 - **port:** SIP port
- **Type:** type of action
 - **add:** add a new header. If the header already exists the action is skipped
 - **set:** replace value of an existing header. If the header does not exist the action is skipped
 - **remove:** remove an existing header
 - **header:** copy a value (or a part) from an existing header to this header
 - **preference:** copy a value (or a part) from an existing preference to this header
 - **rsub:** apply regex substring to the current header. format: `match; replace` (e.g: `value=1234567 rsub=^12 ([0-9]45) 67$; result=345`)
- **Value Part:** if the value is a SIP-URI then it is possible to pick which part of the value should be used
 - **full:** the entire value
 - **username:** SIP username
 - **domain:** SIP domain
 - **port:** SIP port
- **Value:** value to apply or a header name if `Type=header`, or a preference name if `Type=preference`. **NOTE:** support inline \$avp transformations, e.g: if `$avp(s:source_cli)=456` then `123$avp(s:source_cli)789` is evaluated as `123456789`

- `Rewrite Rule Set`: if the header value needs to be normalised after evaluation then an existing `Rewrite Rule Set` can be used for that, it is mandatory to select a header rules part when the option is used
- `Rewrite Rule`: Rewrite Rules to use from the selected `Rewrite Rule Set`
 - Inbound for Caller
 - Inbound for Callee
 - Outbound for Caller
 - Outbound for Callee

6.36.6 Special Headers

There are special header names, they can be use in conditions and set in actions. The names are case insensitive.

- `@Request-URI`: retrieve or modify RURI of the SIP message
- `@Reply-Status`: retrieve or modify the reply status (e.g: 486). Can only be used in the `reply` direction. **NOTE::** reply status 1xx and 2xx cannot be changed as well as cannot be set
- `@Reply-Reason`: retrieve or modify the reply reason (e.g: Request Terminated). Can only be used in the `reply` direction

6.36.7 Usage

To start using Header Manipulations a Set needs to be created. Then one or more Rules should be created with a `Direction` depending on when you need modify the headers. If there are headers to adjust before any proxy logic processing takes place, then `Direction inbound` should be used. If there are headers to adjust right before the SIP message leaves the proxy then `Direction outbound` should be used. Once you created a Rule it is time to add at least one Condition and one Action, otherwise the Rule is skipped. Condition is an expression that you use to check if one or more headers of the SIP message (or an \$avp in expert cases) exist and their values match the expression, otherwise the Rule is skipped and next one with the same `Direction` and by `Priority` is evaluated. If all Conditions of the Rule are evaluated as `True` then all Actions of the Rule are applied. If the `Stopper` flag is `True` then the processing ends, otherwise next Rule in line is evaluated.

Set can be assigned to a domain in the `Domain preferences` and is automatically inherited by all subscribers of the domain. It can be also applied to the `Peering preferences`. It is possible to override the Set per subscriber in the `Subscriber preferences`.

It is also possible to have `Subscriber only Rules`, they are created in the admin UI via the `Subscriber preferences` and in the API they are created via `/api/headerrulesets`. Internally it is a Set but with a defined `subscriber_id`. It is only possible to have one Set like this per subscriber. It is automatically created when used from the admin UI and you only work on the Rules level. This is useful when there is something specific that needs to be modified in the headers for particular subscriber(s). When Rules are applied in the logic the `Domain/Subscriber Set` is applied first and then per subscriber defined Rules if defined.

6.36.8 Usage Examples

6.36.8.1 Inbound Call Add Diversion header

Goal: if From username starts with 43, add Diversion header if it does not exist and skip if already exists

```
Rule:
  Name: add_diversion
  Description: Add Diversion
  Priority: 1
  Direction: inbound
  Stopper: 0
  Enabled: 1

  Conditions:
  -
    Match: header
    Part: username
    Name: From
    Expression: matches
    Not: 0
    Type: input
    Values:
      43*
    Enabled: 1
    Rewrite Rule Set:
    Rewrite Rule:

  Actions:
  -
    Priority: 1
    Header: Diversion
    Header Part: full
    Type: add
    Value Part: full
    Value: sip:431001@sipwise.com
    Rewrite Rule Set:
    Rewrite Rule:
```

6.36.8.2 Outbound Add or Replace X-Test header

Goal: if From username equals to subscriber preference cli, add X-Test header if it does not exist or replace it if exists

```
Rule:
```

```
Name: add_replace_x_test
Description: Add or Replace X-Test
Priority: 1
Direction: outbound
Stopper: 0
Enabled: 1
```

Conditions:

-

```
Match: header
Part: username
Name: From
Expression: is
Not: 0
Type: preference
Values:
  cli
Enabled: 1
Rewrite Rule Set:
Rewrite Rule:
```

Actions:

-

```
Priority: 1
Header: X-Test
Header Part: full
Type: add
Value Part: full
Value: sip:430001@sipwise.com
Rewrite Rule Set:
Rewrite Rule:
```

-

```
Priority: 2
Header: X-Test
Header Part: full
Type: set
Value Part: full
Value: sip:430001@sipwise.com
Rewrite Rule Set:
Rewrite Rule:
```

6.36.8.3 Remove P-Asserted-Identity, Replace Diversion, Add X-Test

Goal: if a call is terminated to a local subscriber and P-Asserted-Identity exists, and its domain part contains sipwise.com or sipwise.local, Replace Diversion with the value from P-Asserted-Identity, remove P-Asserted-Identity and add X-Test with a value from the cli preference

Rule:

Name: local_pai_diversion_x_test
Description: Local remove PAI, replace Diversion, add X-Test
Priority: 1
Direction: local
Stopper: 0
Enabled: 1

Conditions:

-
Match: header
Part: domain
Name: P-Asserted-Identity
Expression: contains
Not: 0
Type: input
Values:
 sipwise.com
 sipwise.local
Enabled: 1
Rewrite Rule Set:
Rewrite Rule:

Actions:

-
Priority: 1
Header: Diversion
Header Part: full
Type: header
Value Part: full
Value: P-Asserted-Identity
Rewrite Rule Set:
Rewrite Rule:
-
Priority: 2
Header: P-Asserted-Identity
Header Part: full
Type: remove
Value Part: full
Value:
Rewrite Rule Set:
Rewrite Rule:
-
Priority: 3
Header: X-Test
Header Part: full

```
Type: preference
Value Part: full
Value: cli
Rewrite Rule Set:
Rewrite Rule:
```

6.37 Phonebook

6.37.1 Overview

Phonebook enables on the NGCP platform a configurable list of entries (name⇒number) per Reseller, Customer or Subscriber that are provisioned on the subscribers' devices (phones) and presented there as an external phonebook.

6.37.2 Inheritance

- Entries that are defined on `Reseller` level are automatically included into the subscriber's phonebook unless overridden on `Customer` or `Subscriber` levels.
- Entries that are defined on `Customer` level override matching entries from `Reseller` level and automatically included into the subscriber's phonebook unless overridden on `Subscriber` level.
- Entries that are defined on `Subscriber` level override matching entries from `Reseller` and `Customer` levels and automatically included into the subscriber's phonebook.

Overrides uses the number field for matching.

6.37.3 Reseller Phonebook

To manage Reseller Phonebook you must be an admin user, there is a `Phonebook` entry in Settings dropdown list.

Create Phonebook
✕

Reseller Search:

#	Name	Contract #	Status	
1	default	1	active	<input type="checkbox"/>

Showing 1 to 1 of 1 entries

Name

Number

Figure 82: Create Reseller Phonebook Entry

- Name: Enter a name for the entry (e.g.: Emergency Number or Alice)
- Number: E164 number. The format is free but E164 is preferred so that the entries can be overridden when needed on Customer or Subscriber levels.

6.37.4 Customer Phonebook

Customer Phonebook is located as one of the available Customer detail entries.

Phonebook

Search:

Show entries

#	Name	Number	
1	Alice	4310001	

Showing 1 to 1 of 1 entries

Figure 83: Customer Phonebook Entries

In the given example there is Alice number defined in the phonebook, so it is shared across all subscribers of the customer,

plus numbers from Reseller Phonebook.

6.37.5 Subscriber Phonebook

Subscriber Phonebook is located as one of the available Subscriber detail entries.

Phonebook

★ Create Phonebook Entry ★ Download CSV ★ Upload CSV

Show 5 entries Search:

#	Name	Number	Shared
1	Bob	4310002	0
3	Carol	4310003	1

Showing 1 to 2 of 2 entries ← ← 1 → →

Figure 84: Subscriber Phonebook Entries

In the given example there is `Bob` and `Carol` numbers defined in the phonebook.

There is a new field on Subscriber level, *Shared*, it defines whether the number is private to the subscriber, if *Shared=0*, or shared across other subscribers of the same customer if *Shared=1*.

Therefore, `Bob` is private to the subscriber and `Carol` entry is shared.

6.37.6 Using CSV Upload and Download

Clicking *Download CSV* automatically downloads all entries of the level into a csv file. The downloaded entries are exactly ones in the phonebook and inheritance is not used in this case.

Clicking *Upload CSV* opens a dialog.

- Upload phonebook: choose a local .csv file with expected fields *"Name"*, *Number*, and *Shared* if uploaded into Subscriber level. It is a good practice to quote name to resolve situations with spaces. Commas must be escaped with `\`.

```
phonebook_upload.csv
"Shaw\, Alice",4310001
```

```
phonebook_upload_subscriber.csv
"Shaw\, Alice",4310001,0
"Bob",4310002,1
```

- `Purge existing`: if checked, deletes all existing entries before uploading new ones, otherwise the entries are merged by the `Number` field, where new entries override old entries on match.

6.37.7 Manually enabling Phonebook in a PBX device

Currently supported devices:

- Cisco SPA
- Panasonic
- Yealink

1. In your provisioned PBX device, fetch its MAC address.

2. Open Directory/Remote Phonebook and enter one of the supported URLs depending on the device model:

- Cisco SPA: `https://$host:$port/pbx/directory/spa/$mac`
- Panasonic: `https://$host:$port/pbx/directory/panasonic/userid=$mac`
- Yealink: `https://$host:$port/pbx/directory/yealink/userid=$mac`

Where `host` is the NGCP host and `port` is the API configured port.

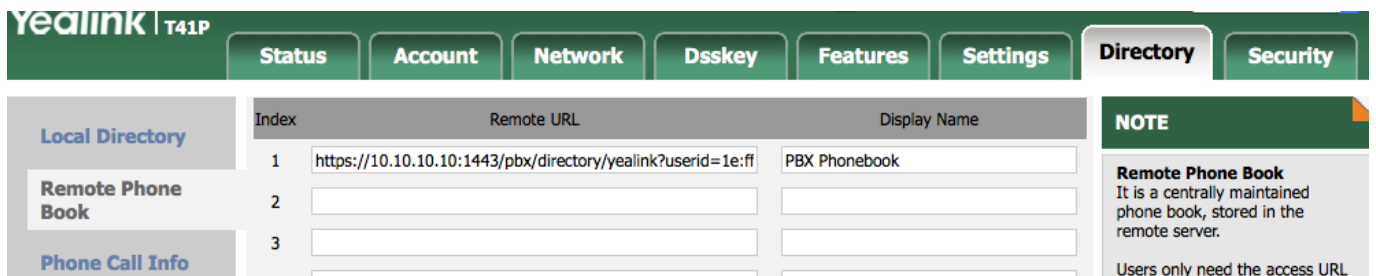

Figure 85: Phonebook Device Provisioning

7 Customer Self-Care Interface and Menus

There are two ways for end users to maintain their subscriber settings: via the *Customer Self-Care Web Interface* and via *Vertical Service Codes* using their SIP phones.

7.1 The Customer Self-Care Web Interface

The Sipwise C5 provides a web panel for end users (CSC panel) to maintain their subscriber accounts, which is running on <https://ngcp-ip>. Every subscriber can log in there, change subscriber feature settings, view their call lists, retrieve voicemail messages and trigger calls using the click-to-dial feature.

7.1.1 Login Procedure

To log into the CSC panel, the end user has to provide his full web username (e.g. `user1@1.2.3.4`) and the web password defined in Section 5.3. Once logged in, he can change his web password in the *Account* section. This will NOT change his SIP password, so if you control the end user devices, you can auto-provision the SIP password into the device and keep it secret, and just hand over the web password to the customer. This way, the end user will only be able to place calls with this auto-provisioned device and not with an arbitrary soft-phone, but can nonetheless manage his account via the CSC panel.

7.1.2 Site Customization

As an operator (as well as a Reseller), you can change the branding logo of the Customer Self-Care (CSC) panel and the available languages on the CSC panel. This is possible via the admin web interface.

7.1.2.1 Changing the Logo

For changing the branding logo on a reseller's admin web page and on the CSC panel you just need to access the web interface **as Administrator** and navigate to *Reseller* menu. Once there click on the *Details* button for your selected reseller, finally select *Branding*.

In order to do the same **as Reseller**, login on the admin web interface with the reseller's web credentials, then access the *Panel Branding* menu.

The web panel customisation happens as follows:

1. Press the *Edit Branding* button to start the customisation process.
2. Press the *Browse* button to select an image for the new logo:

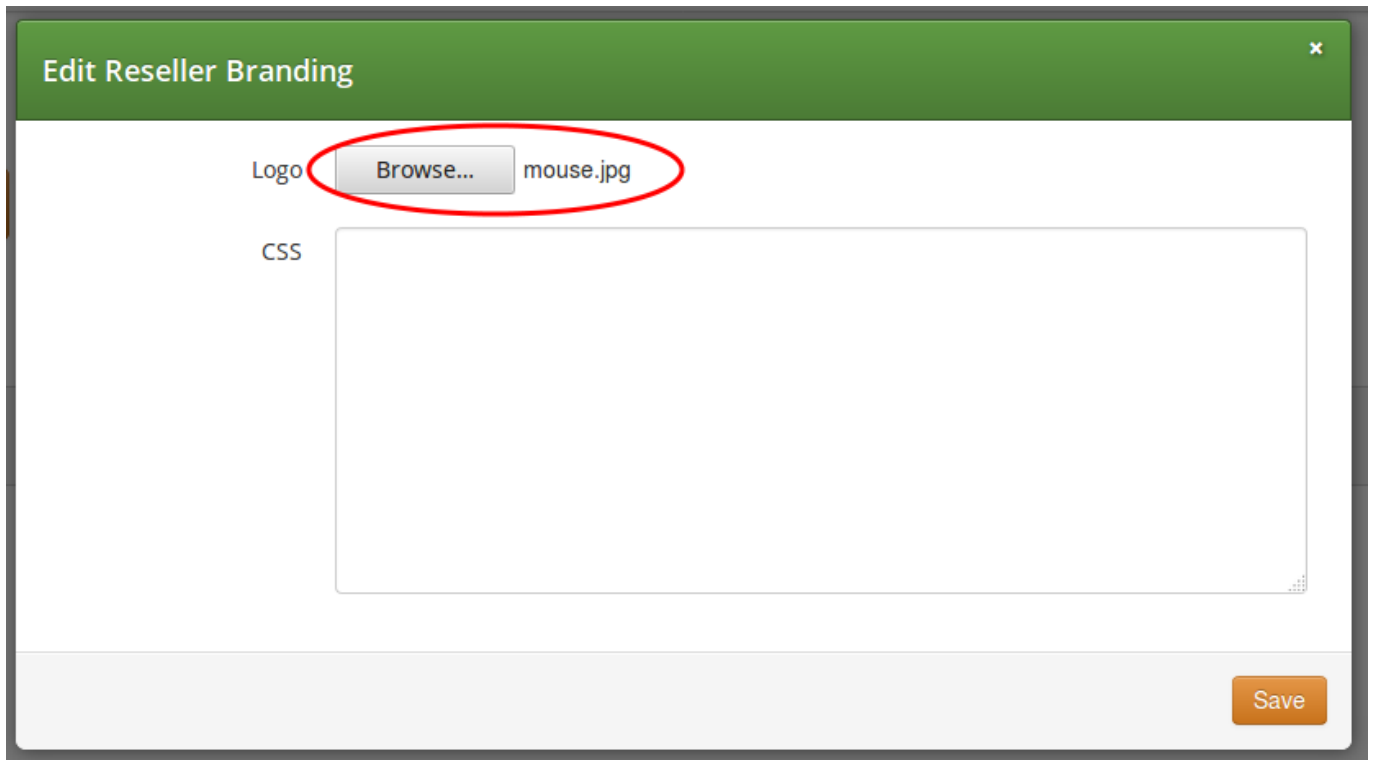



Figure 86: CSC Customisation Step 1: Select an image

3. Press the *Save* button to save changes.
4. Select and copy the auto-generated CSS code from the text box below the uploaded image:

Reseller branding successfully updated

[Edit Branding](#) [Delete Logo](#)

Custom Logo



You can use the logo by adding the following CSS to the Custom CSS below.

```
#header .brand {  
  background: url(https://10.15.18.227:1443/reseller/3/css/logo/download) no-repeat 0 0;  
  background-size: 280px 32px;  
}
```

Custom CSS

Figure 87: CSC Customisation Step 2: Copy CSS code

5. Press the *Edit Branding* button again.
6. Paste the CSS code into CSS text box and Save the changes:

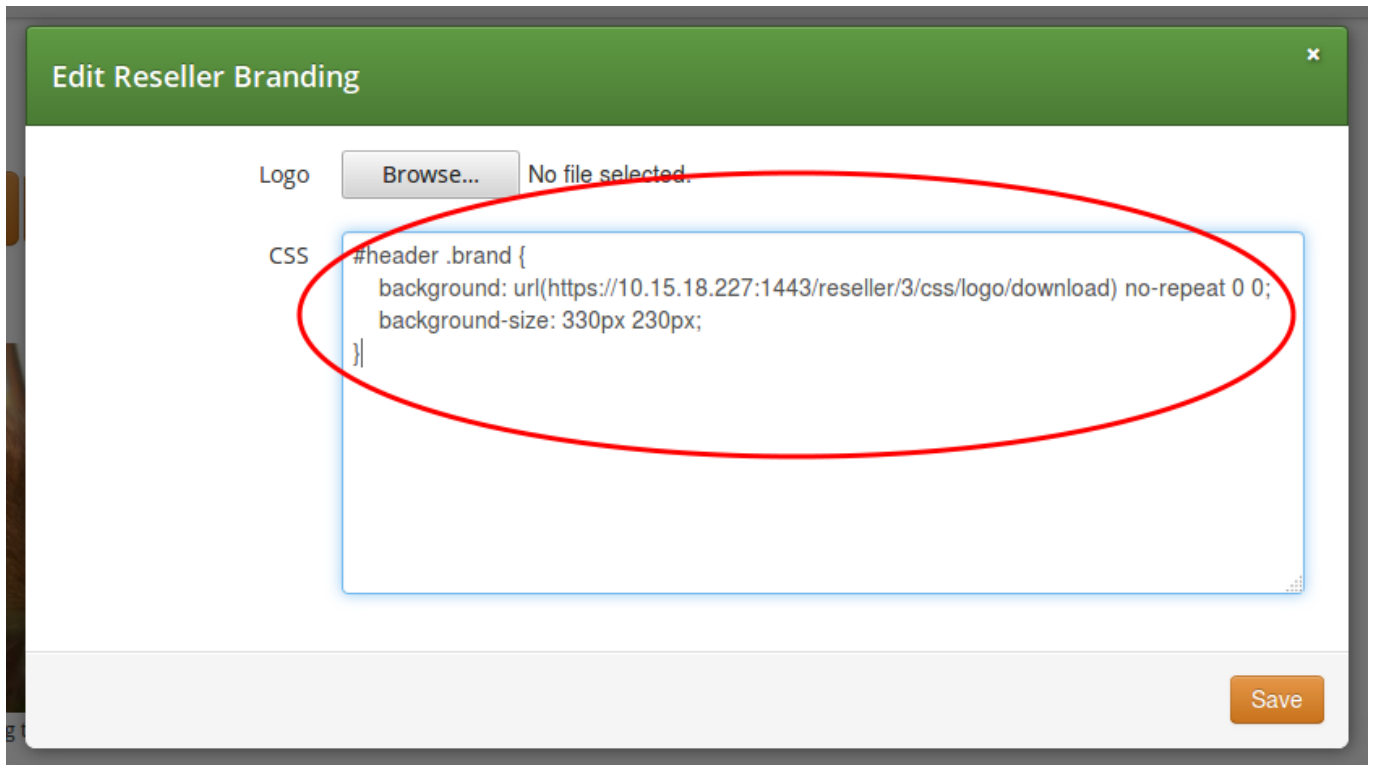

Figure 88: CSC Customisation Step 3: Paste CSS code

7. Now the new logo is already visible on the admin / CSC panel. If you want to hide the Sipwise copyright notice at the bottom of the web panels, add a line of CSS code as shown here:

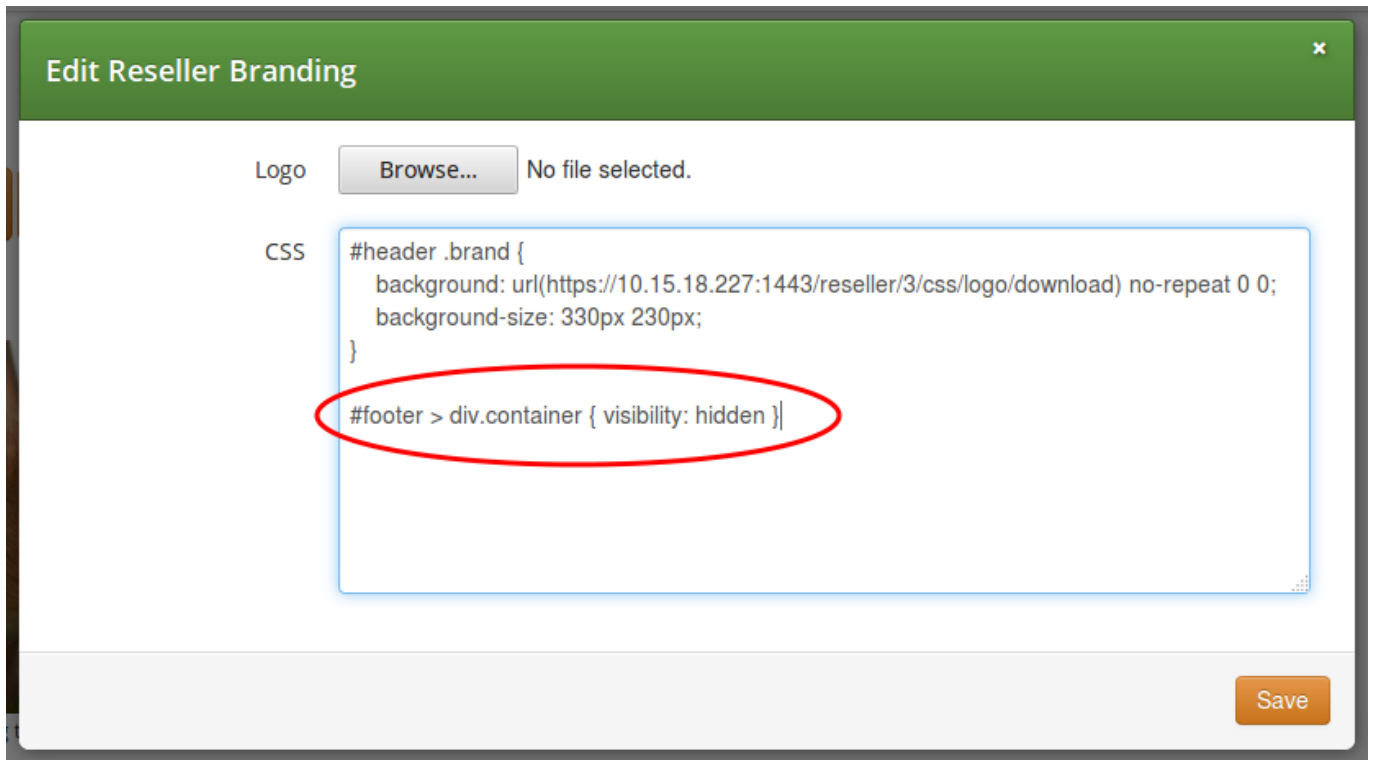

Figure 89: CSC Customisation: Hide copyright notice

8. The final branding data is shown on the admin web panel:

Reseller branding successfully updated

[Edit Branding](#) [Delete Logo](#)

Custom Logo



You can use the logo by adding the following CSS to the Custom CSS below:

```
#header .brand {
  background: url(https://10.15.18.227:1443/reseller/3/css/logo/download) no-repeat 0 0;
  background-size: 280px 32px;
}
```

Custom CSS

```
#header .brand {
  background: url(https://10.15.18.227:1443/reseller/3/css/logo/download) no-repeat 0 0;
  background-size: 330px 230px;
}

#footer > div.container { visibility: hidden }
```

Figure 90: CSC Customisation: Custom data on panel

7.1.2.2 Other Website Customisations

The layout and style of NGCP's admin and CSC web panel is determined by a single CSS file: `/usr/share/ngcp-panel/static/`

More complex changes, like replacing colour of some web panel components, is possible via the modification of the CSS file.



Warning

Only experienced users with profound CSS knowledge are advised to change web panel properties in the main CSS file. *Sipwise does not recommend and also does not support the modification of the main CSS file.*

7.1.2.3 Selecting Available Languages

You can also enable/disable specific languages a user can choose from in the CSC panel. Currently, English (`en`), German (`de`), Italian (`it`), Spanish (`es`) and Russian (`ru`) are supported, and the default language is the same as the browser's preferred one.

You can select the *default language* provided by CSC by changing the parameter `www_admin.force_language` in `/etc/ngcp-co` file. An example to set the English language as default: `force_language: en`

7.2 The Voicemail Menu

Sipwise C5 offers several ways to access the Voicemail box.

The CSC panel allows your users to listen to voicemail messages from the web browser, delete them and call back the user who left the voice message. User can setup voicemail forwarding to the external email and the PIN code needed to access the voicebox from any telephone also from the CSC panel.

To manage the voice messages from SIP phone: simply dial internal voicemail access number 2000.

To change the access number: look for the parameter *voicemail_number* in */etc/ngcp-config/config.yml* in the section *sems*→*vsc*. After the changes, execute *ngcpcfg apply 'changed voicebox number'*.

Tip

To let the callers leave a voice message when user is not available he should enable Call Forward to Voicebox. The Call Forward can be provisioned from the CSC panel as well as by dialing Call Forward VSC with the voicemail number. E.g. when parameter *voicemail_number* is set to 9999, a Call Forward on Not Available to the Voicebox is set if the user dials *93*9999. As a result, all calls will be redirected to the Voicebox if SIP phone is not registered.

To manage the voice messages from any phone:

- As an operator, you can setup some DID number as external voicemail access number: for that, you should add a special rewrite rule (Inbound Rewrite Rule for Callee, see Section 5.7.) on the incoming peer, to rewrite that DID to "voiceboxpass". Now when user calls this number the call will be forwarded to the voicemail server and he will be prompted for mailbox and password. The mailbox is the full E.164 number of the subscriber account and the password is the PIN set in the CSC panel.
- The user can also dial his own number from PSTN, if he setup Call Forward on Not Available to the Voicebox, and when reaching the voicemail server he can interrupt the "user is unavailable" message by pressing * key and then be prompted for the PIN. After entering PIN and confirming with # key he will enter own voicemail menu. PIN is random by default and must be kept secret for that reason.

8 Billing Configuration

This chapter describes the steps necessary to rate calls and export rated CDRs (call detail records) to external systems.

8.1 Billing Profiles

Service billing on Sipwise C5 is based on billing profiles, which may be assigned to customers and SIP peerings. The design focuses on a simple, yet flexible approach, to support arbitrary dial-plans without introducing administrative overhead for the system administrators. The billing profiles may define a base fee and free time or free money per billing interval. Unused free time or money automatically expires at the end of the billing interval.

Each profile may have call destinations (usually based on E.164 number prefix matching) with configurable fees attached. Call destination fees each support individual intervals and rates, with a different duration and/or rate for the first interval. (e.g.: charge the first minute when the call is opened, then every 30 seconds, or make it independent of the duration at all) It is also possible to specify different durations and/or rates for peak and off-peak hours. Peak time may be specified based on weekdays, with additional support for manually managed dates based on calendar days. The call destinations can finally be grouped for an overview on user's invoices by specifying a zone in two detail levels. (E.g.: national landline, national mobile, foreign 1, foreign 2, etc.)

8.1.1 Creating Billing Profiles

The first step when setting up billing data is to create a billing profile, which will be the container for all other billing related data. Go to *Settings*→*Billing* and click on *Create Billing Profile*.

The screenshot shows the 'Create Billing Profiles' dialog box. At the top, it says 'Reseller' and 'Search:'. Below is a table with columns: #, Name, Contract #, Status, and an action column. The table contains one entry: #1, Name: default, Contract #: 1, Status: active. The action column has a checkbox with a checkmark, highlighted with a red box and the number 1. Below the table, it says 'Showing 1 to 1 of 1 entries' and 'Create Reseller'. There are three input fields: 'Handle' with the value 'mytestprofile' (highlighted with a red box and the number 2), 'Name' with the value 'My Test Profile' (highlighted with a red box and the number 3), and 'Interval charge' with the value '0'. There is also a 'Prepaid' checkbox which is unchecked. At the bottom right, there is a 'Save' button highlighted with a red box and the number 4.

The fields *Reseller*, *Handle* and *Name* are mandatory.

- **Reseller:** The reseller this billing profile belongs to.
- **Handle:** A unique, permanently fixed string which is used to attach the billing profile to a customer or SIP peering contract.
- **Name:** A free form string used to identify the billing profile in the *Admin Panel*. This may be changed at any time.
- **Prepaid:** Enables prepaid accounting for this profile as opposed to normal post-paid mode.
- **Prepaid library:** one of available prepaid libraries to use for the prepaid accounting
- **Advice of charge:** Enables Advice of Charge support to send call costs in the SIP INFO messages back to the caller. The *Billing Fees* are used in the cost and interval calculations.
- **Interval charge:** A base fee for the billing interval, specifying a monetary amount (represented as a floating point number) in whatever currency you want to use.
- **Interval free time:** If you want to include free calling time in your billing profile, you may specify the number of seconds that are available every billing interval. See *Creating Billing Fees* below on how to select destinations which may be called using the free time.
- **Interval free cash:** Same as for *interval free time* above, but specifies a monetary amount which may be spent on outgoing calls. This may be used for example to implement a minimum turnover for a contract, by setting the *interval charge* and *interval free cash* to the same values.

- **Fraud monthly limit:** The monthly fraud detection limit (in Cent) for accounts with this billing profile. If the call fees of an account reach this limit within a billing interval, an action can be triggered.
- **Fraud monthly lock:** a choice of *none, foreign, outgoing, incoming, global*. Specifies a lock level which will be used to lock the account and his subscribers when *fraud monthly limit* is exceeded.
- **Fraud monthly notify:** An email address or comma-separated list of email addresses that will receive notifications when *fraud monthly limit* is exceeded.
- **Fraud daily limit:** The fraud detection limit (in Cent) for accounts with this billing profile. If the call fees of an account reach this limit within a calendar day, an action can be triggered.
- **Fraud daily lock:** a choice of *none, foreign, outgoing, incoming, global*. Specifies a lock level which will be used to lock the account and his subscribers when *fraud daily limit* is exceeded.
- **Fraud daily notify:** An email address or comma-separated list of email addresses that will receive notifications when *fraud daily limit* is exceeded.
- **Currency:** The currency symbol for your currency. Any UTF-8 character may be used and will be printed in web interfaces.
- **VAT rate:** The percentage of value added tax for all fees in the billing profile. Currently for informational purpose only and not used further.
- **VAT included:** Whether VAT is included in the fees entered in web forms or uploaded to the platform. Currently for informational purpose only and not used further.

8.1.2 Creating Billing Fees

Each *Billing Profile* holds multiple *Billing Fees*.

To set up billing fees, click on the *Fees* button of the billing profile you want to configure. Billing fees may be uploaded using a configurable CSV file format, or entered directly via the web interface by clicking *Create Fee Entry*. To configure the CSV field order for the file upload, rearrange the entries in the `www_admin→fees_csv→element_order` array in `/etc/ngcp-config/config.yml` and execute the command `ngcpcfg apply changed fees element order`. The following is an example of working CSV file to upload (pay attention to double quotes):

```

".", "^1", out, "EU", "ZONE EU", 5.37, 60, 5.37, 60, 5.37, 60, 5.37, 60, 0, 0, regex_longest_pattern
"^01.+$", "^02145.+$", out, "AT", "ZONE Test", 0.06250, 1, 0.06250, 1, 0.01755, 1, 0.01733, 1, 0, ↔
regex_longest_pattern, 30, 0.01, 30, 0.01

```

For input via the web interface, just fill in the text fields accordingly.

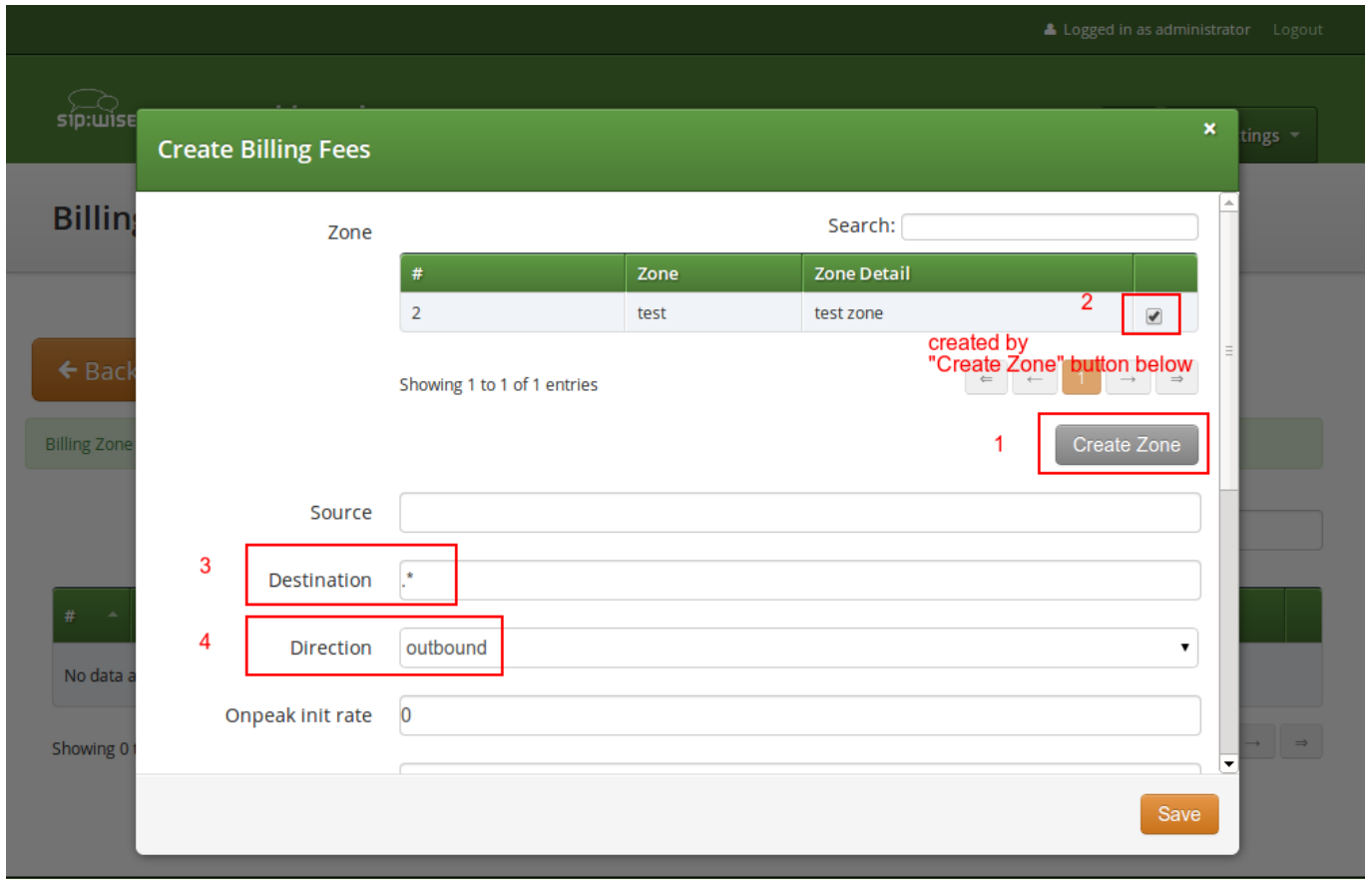

A billing fee record essentially defines the rate per interval to charge the customer when calling a particular destination number. The properties below outline supported options in detail:

- **Zone:** A zone for a group of fees. May be used to group fees for simplified display, e.g. on invoices. (e.g. `foreign zone 1`)
- **Match Mode:** The mode for matching a fee's source and destination patterns against a CDR's source fields (the caller given by `<source_cli>@<source_domain>` or `<source_cli>` only) and destination fields (the callee given by `<destination_user_in>` or `<destination_user_in>` only). Each of the currently supported modes below provide different flexibility and speed:
 1. Exact string (destination): The destination string has to match the destination from the CDR exactly. Fastest, $O(\log(\#fees))$. In csv files, this match mode is specified by `exact_destination`.
 2. Prefix string: The fee's source/destination represent strings which both the source/destination from the CDR have to start with. The fee with the longest destination prefix is picked. If there are multiple, the one with the longest source prefix is picked. In contrast to regular-expression based match modes, this algorithm uses database index lookups instead of SQL REGEXP table scans. The performance boundary is $O(\text{length}(\text{cdr src}) * \text{length}(\text{cdr dest}) * \log(\#fees))$, hence this will be the preferred mode for tens of thousands of fees in place or high throughput (LCR, rating peer-to-peer calls). In csv files, this match mode is specified by `prefix`.
 3. Regular expression - longest match: The fee's source/destination patterns represent PCREs which both have to match the source/destination from the CDR. The fee with the longest match within the destination string is picked. If there are multiple, the one with the longest match within the source string is picked. In csv files, this match mode is specified by `regex_longest_match`.
 4. Regular expression - longest pattern: The fee's source/destination represent PCREs which both have to match the

source/destination from the CDR. The fee with the longest (most distinctive) destination pattern is picked. If there are multiple, the one with the longest (most distinctive) source pattern is picked. In csv files, this match mode is specified by `regex_longest_pattern`.

If fees with different match mode are in place and matching, the precedence is given by above order. When omitted in file uploads, the legacy default `regex_longest_pattern` is used.

- **Source:** The source pattern (prefix ie. 123 or regular expression `^123someone@sip\.sipwise\.com$`). The legacy default " ." regular expression (matching everything) will be set implicitly.
- **Destination:** The destination pattern (string ie. 456somebody@sip.sipwise.com, prefix ie. 456 or regular expression `^456somebody@sip\.sipwise\.com$`). This field must be set.
 - To specify a special fixed rate for any ported number in the local LNP tables belonging to an LNP provider, a fee with `exact_destination` match mode and `destination_lnp:<lnp_provider ID>` can be set up.
 - To specify an FCI (Furnished Charging Info) destination for cases when the FCI data is retrieved from the LNP lookup, use a format `fci=10050` where "10050" is the FCI data.
- **Direction:** `Outbound` for standard origination fees (applies to callers placing a call and getting billed for that) or `Inbound` for termination fees (applies to callees if you want to charge them for receiving various calls, e.g. for 800-numbers). *If in doubt, use Outbound.* If you upload fees via CSV files, use `out` or `in`, respectively.



Important

The {match mode, source, destination, direction} combination needs to be unique for a billing profile. The system will return an error if such a set is specified twice via web interface/ or /api, or skipped when processing the file upload. When uploading fees, the *Purge Existing* checkbox allows to drop all existing fees before creating the records.



Important

There are several internal services (vsc, conference, voicebox, fax2mail) which will need a specific destination entry with a domain-based destination. If you don't want to charge the same (or nothing) for those services, add a fee for destination `\.local$` there. If you want to charge different amounts for those services, break it down into separate fee entries for `@fax2mail\.local$`, `@vsc\.local$`, `@conference\.local$` and `@voicebox\.local$` with the according fees. **NOT CREATING EITHER THE CATCH-ALL FEE OR THE SEPARATE FEES FOR THE .local DOMAIN WILL BREAK YOUR RATING PROCESS!**

- **Onpeak init rate:** The rate for the first rating interval in cent (of whatever currency, represented as a floating point number) per second. Applicable to calls during onpeak hours.
- **Onpeak init interval:** The duration of the first billing interval, in seconds. Applicable to calls during onpeak hours.
- **Onpeak follow rate:** The rate for subsequent rating intervals in cent (of whatever currency, represented as a floating point number) per second. Applicable to calls during onpeak hours. Defaults to *onpeak init rate*.
- **Onpeak follow interval:** The duration of subsequent billing intervals, in seconds. Applicable to calls during onpeak hours. Defaults to *onpeak init interval*.

- **Offpeak init rate:** The rate for the first rating interval in cent (of whatever currency, represented as a floating point number) per second. Applicable to calls during off-peak hours. Defaults to *onpeak init rate*.
- **Offpeak init interval:** The duration of the first billing interval, in seconds. Applicable to calls during off-peak hours. Defaults to *onpeak init interval*.
- **Offpeak follow rate:** The rate for subsequent rating intervals in cent (of whatever currency, represented as a floating point number) per second. Applicable to calls during off-peak hours. Defaults to *offpeak init rate* if that one is specified, or to *onpeak follow rate* otherwise.
- **Offpeak follow interval:** The duration of subsequent billing intervals, in seconds. Applicable to calls during off-peak hours. Defaults to *offpeak init interval* if that one is specified, or to *onpeak follow interval* otherwise.
- **Onpeak use free time:** Specifies whether free time minutes may be used when calling this destination during onpeak hours. Specified in the file upload as 0, n[o], f[alse] and 1, y[es], t[rue] respectively.
- **Offpeak use free time:** Specifies whether free time minutes may be used when calling this destination during off-peak. Specified in the file upload as 0, n[o], f[alse] and 1, y[es], t[rue] respectively.
- **Onpeak extra second:** If defined, an extra rate will be charged at the given second of call time for post-paid calls. Applicable to calls started during onpeak hours.
- **Onpeak extra rate:** The rate to charge if the call time exceeds *extra second* in cent (of whatever currency, represented as a floating point number). Applicable to calls started during onpeak hours.
- **Offpeak extra second:** See onpeak extra second. Applicable to calls started during offpeak hours.
- **Offpeak extra rate:** See onpeak extra rate. Applicable to calls started during offpeak hours.

8.1.3 Creating Off-Peak Times

To be able to differentiate between on-peak and off-peak calls, the platform stores off-peak times for every billing profile based on weekdays and/or calendar days. To edit the settings for a billing profile, go to *Settings*→*Billing* and press the *Off-Peaktimes* button on the billing profile you want to configure.

To set off-peak times for a weekday, click on *Edit* next to the according weekday. You will be presented with two input fields which both receive a timestamp in the form of *hh:mm:ss* specifying a time of day for the start and end of the off-peak period. If any of the fields is left empty, the system will automatically insert *00:00:00* (*start* field) or *23:59:59* (*end* field). Click on *Add* to store the setting in the database. You may create more than one off-peak period per weekday. To delete a range, just click *Delete* next to the entry. Click the *close* icon when done.

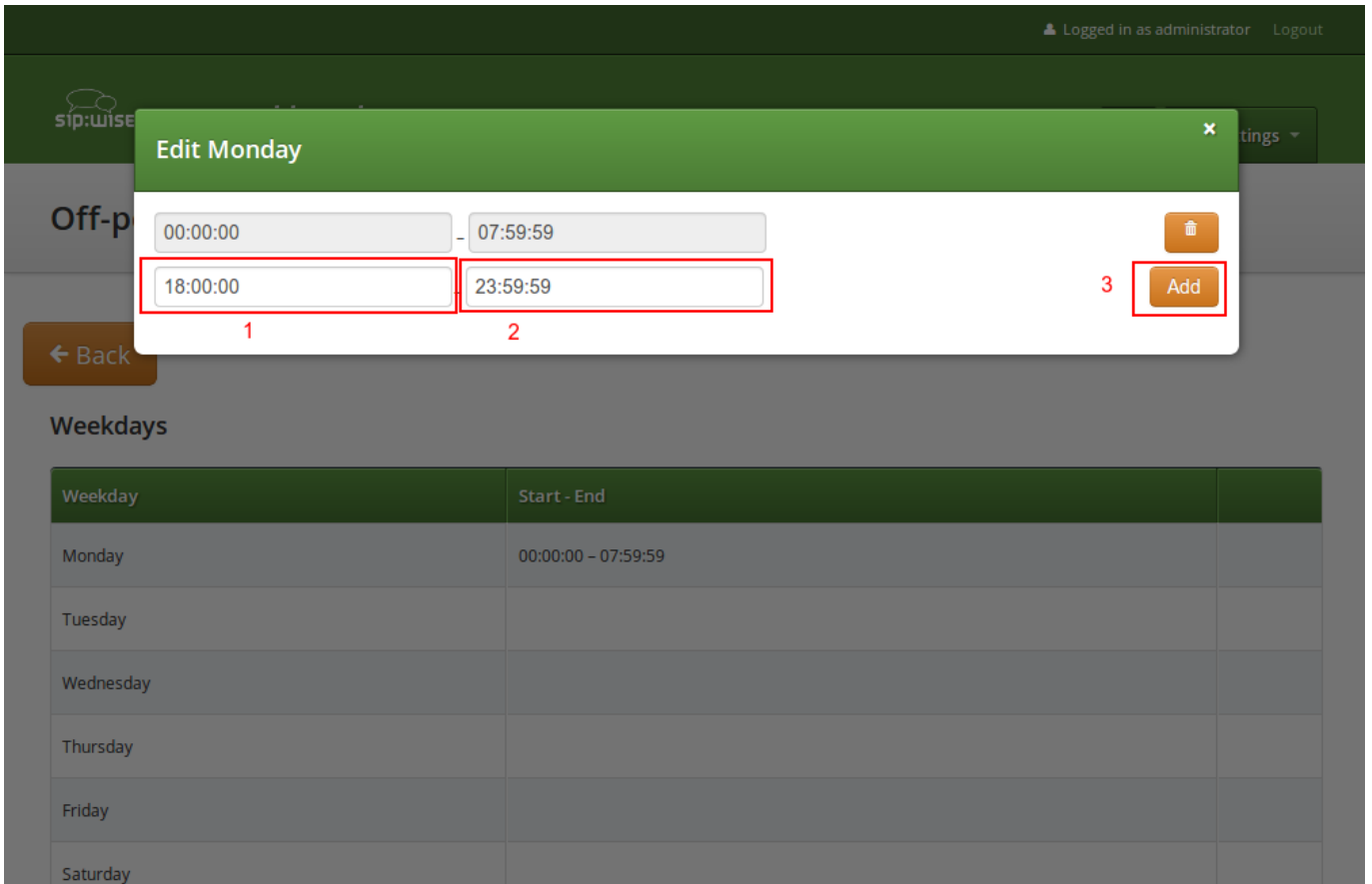

To specify off-peak ranges based on calendar dates, click on *Create Special Off-Peak Date*. Enter a date in the form of *YYYY-MM-DD hh:mm:ss* into the *Start Date/Time* input field and *End Date/Time* input field to define a range for the off-peak period.

1 Start Date/Time 2013-12-24 00:00:00

2 End Date/Time 2013-12-24 23:59:59

3 Save

Weekday	Start - End
Monday	00:00:00 - 07:59:59 18:00:00 - 23:59:59
Tuesday	
Wednesday	
Thursday	
Friday	

8.2 Peak Time Call Rating Modes

8.2.1 Introduction to Call Rating Modes

The call rating engine component (*ngcp-rate-o-mat*) supports two different modes to consider configured off-peak/on-peak periods when calculating call costs:

- **Split-Peak-Parts mode:** CDRs reflecting calls which cross an off-peak/on-peak period transition will be split into two CDR fragments. This way it is possible for each fragment to exactly mark it as either on-peak or off-peak, and the CDR's *frag_carrier_onpeak*, *frag_reseller_onpeak* and *frag_customer_onpeak* fields can be populated accordingly.

CDRs that are entirely within either on-peak or off-peak periods are not split and show a value of 0 for their *is_fragmented* field. CDR fragments are marked by the *is_fragmented* field showing a value of 1. If the call is crossing n transitions, $(n+1)$ fragments are created.

Apart from *is_fragmented*, **_onpeak* and **_cost* fields, each fragment is a copy of the original CDR, except for *start_time* and *duration* fields. The sum of *duration* of fragments is equal to the *duration* of the original CDR. Fragments are adjacent, so the *start_time* of a fragment is equal to the end time (*start_time* + *duration*) of the previous fragment.

- **Regular mode:** In regular mode, the costs are calculated by summing up init/follow interval ticks, and selecting on-peak or off-peak rates of the billing fee per tick. Resulting call costs will be identical to the sum of the costs of fragmented CDRs in Split-Peak-Parts mode, but now comprised of both on-peak and off-peak rates in a single value. Hence *frag_carrier_onpeak*, *frag_reseller_onpeak* and *frag_customer_onpeak* CDR fields cannot be provided.

8.2.2 Typical Use Cases for Call Rating Modes

The CDR fragmentation produced by **Split-Peak-Parts mode** can be useful when implementing:

- End-customer invoicing to **separate** call listings or costs by **off-peak and on-peak**
- Reports to compare sums of carrier and customer costs when fees with **different metering** (given by the fees' init and follow interval) are in effect

The process of the **regular mode** does not create additional CDRs, which has advantages in other situations:

- It is easy to **re-rate** CDRs, as there is no need to revert fragmentation.
- The concept of **one-CDR-per-call-leg** is kept, which simplifies external rating, reporting, call-flow visualisation etc.

8.2.3 Configuration of Call Rating Modes

The regular mode is enabled by default. To enable Split-Peak-Parts mode, set `rateomat.splitpeakparts` to 1 in `/etc/ngcp-co` file.

8.3 Prepaid Accounting

In a normal post-paid accounting scenario, each customer accumulates debt in their billing account, which at the end of the billing interval is then billed to the customer. A *prepaid* billing profile reverses this sequence: the customer first has to provide credit to their account balance, and the costs for all calls are then deducted from that account balance. Once the balance reaches zero, no further calls from this customer are accepted, with the exception of free calls. Additionally, if the balance drops to zero while any calls are currently active, Sipwise C5 will disconnect those calls as soon as that happens.

With prepaid billing enabled, all details of the billing profile and all details of the billing fees behave as they normally do, including interval free time. If any interval free time is given, the free time will be used before the account's credit is.

Important



For technical reasons, the system can make the distinction between on-peak and off-peak times only at call establishment time. In other words, if the currently active call fee at the moment when the call is established is an off-peak fee, then the same off-peak fee will remain active for the whole length of this call, even if the call actually transitions into an on-peak fee (and vice versa).

Important



For technical reasons, prepaid billing can't charge local endpoint calls to Voicebox, VSC calls or calls to a Conference Room.

The Sipwise C5 platform offers advanced billing features which are especially designed for pre-paid billing scenarios. For details please visit [Billing Customizations](#) section of the handbook.

8.4 Fraud Detection and Locking

The Sipwise C5 supports a fraud detection feature, which is designed to detect accounts causing unusually high customer costs, and then to perform one of several actions upon those accounts. This feature can be enabled and configured through two sets of billing profile options described in Section 8.1.1, namely the monthly (*fraud monthly limit*, *fraud monthly lock* and *fraud monthly notify*) and daily limits (*fraud daily limit*, *fraud daily lock* and *fraud daily notify*). Either monthly/daily limits or both of them can be active at the same time.

Monthly fraud limit check runs once a day, shortly after midnight local time and daily fraud limit check runs every 30min. A background script (managed by cron daemon) automatically checks all accounts which are linked to a billing profile enabled for fraud detection, and selects those which have caused a higher cost than the *fraud monthly limit* configured in the billing profile, within the currently active billing interval (e.g. in the current month), or a higher cost than the *fraud daily limit* configured in the billing profile, within the calendar day. It then proceeds to perform at least one of the following actions on those accounts:

- If **fraud lock** is set to anything other than *none*, it will lock the account accordingly (e.g. if **fraud lock** is set to *outgoing*, the account will be locked for all outgoing calls).
- If anything is listed in **fraud notify**, an email will be sent to the email addresses configured. The email will contain information about which account is affected, which subscribers within that account are affected, the current account balance and the configured fraud limit, and also whether or not the account was locked in accordance with the **fraud lock** setting. It should be noted that this email is meant for the administrators or accountants etc., and not for the customer.

8.4.1 Fraud Lock Levels

Fraud lock levels are various protection (and notification) settings that are applied to subscribers of a *Customer*, if fraud detection is enabled in the currently active billing profile and the *Customer's* daily or monthly fraud limit has been exceeded.

The following lock levels are available:

- *none*: no account locking will happen
- *foreign calls*: only calls within the subscriber's own domain, and emergency calls, are allowed
- *all outgoing calls*: subscribers of the customer cannot place any calls, except calls to free and emergency destinations
- *incoming and outgoing*: subscribers of the customer cannot place and receive any calls, except calls to free and emergency destinations
- *global*: same restrictions as at *incoming and outgoing* level, additionally subscribers are not allowed to access the Customer Self Care (CSC) interface
- *ported*: only automatic call forwarding, due to number porting, is allowed



Important

You can override fraud detection and locking settings of a billing profile on a per-account basis via REST API or the Admin interface.

**Caution**

Accounts that were automatically locked by the fraud detection feature will **not** be automatically unlocked when the next billing interval starts. This has to be done manually through the administration panel or through the provisioning interface.

**Important**

If fraud detection is configured to only send an email and not lock the affected accounts, it will continue to do so for over-limit accounts every day. The accounts must either be locked in order to stop the emails (only currently active accounts are considered when the script looks for over-limit accounts) or some other action to resolve the conflict must be taken, such as disabling fraud detection for those accounts.

Note

It is possible to fetch the list of fraud events and thus get fraud status of *Customers* by using the REST API and referring to the resource: `/api/customerfraudevents`.

Note

Apart from the daily fraud detection check service, Sipwise C5 also provides instant, "hard" locking for prepaid use cases, by means of billing profile packages. See [Billing Profile Packages](#) for reference.

8.5 Billing Customizations

The standard way of doing the billing—i.e. having fixed billing intervals of a calendar month, starting on the 1st day of month—may not fit all billing profiles and intervals that Sipwise C5 platform operators would like to use.

The Sipwise C5 supports—starting from its mr4.2.1 version—alternate ways of defining billing profiles and intervals which are especially worthy for pre-paid scenarios. New functionality is covered by the following titles:

1. [Billing Networks](#)
2. [Profile Mappings Schedule](#)
3. [Profile Packages](#)
4. [Vouchers](#)
5. [Top-up](#)
6. [Balance Overviews](#)
7. [Usage Examples](#)

Subsequent sections will provide an introduction and configuration instructions to these advanced features of Sipwise C5.

8.5.1 Billing Networks

The idea is to dynamically select billing profiles (including fees) depending on the IP network the caller's SIP client is using to connect. The caller's IP is populated in a call's CDR, and effectively processed by:

- the rating engine component (*ngcp-rate-o-mat*) and the
- prepaid interception module (*libswrate*).

The billing profile for rating a call is identified by matching the source IP against network ranges linked to the customer contract's billing mappings records. This feature is sometimes also referred to as *roaming*.

A *Billing Network* is defined as a series of *network blocks* where each network block consists of a *single IP address or an IP subnet*. Blocks of a particular billing network can be defined by either IPv4, or IPv6 addresses but not mixed.

The screenshot shows a web form titled "Create Billing Network". At the top, there is a "Reseller" section with a search box and a table. The table has columns for "#", "Name", "Contract #", and "Status". One row is visible with the following data: #16, Name "Demo Reseller", Contract #200, Status "active". Below the table, it says "Showing 9 to 9 of 9 entries" and there are pagination controls. A "Create Reseller" button is located to the right of the table. Below the table, there are three input fields: "Billing Network Name" with the value "Demo Billing Net 1", "Description" with the value "Some text", and "Billing Network Block" with the value "10.0.1.0 / 24". There is a "Remove" button next to the "Billing Network Block" field. At the bottom right, there is a "Save" button.

Figure 91: Creation of Billing Network

The new `/api/billingnetworks/` **REST API** resource makes it possible to manage billing networks. The example billing network that is shown in the figure above may be defined through the API with this JSON structure:

```
{ "blocks" : [ { "ip" : "10.0.1.0", // subnet: 10.0.1.0 .. 10.0.1.255
                "mask" : 24
              },
              { "ip" : "10.0.2.2" // single ip
              }
            ],
  "description" : "Some text",
  "name" : "Demo Billing Net 1", //unique per reseller
  "reseller_id" : 1
}
```

Input validation of the network blocks is automatically performed by Sipwise C5 during their definition in a way that it prevents specifying overlapping blocks by means of Interval Trees; billing networks themselves may overlap though.

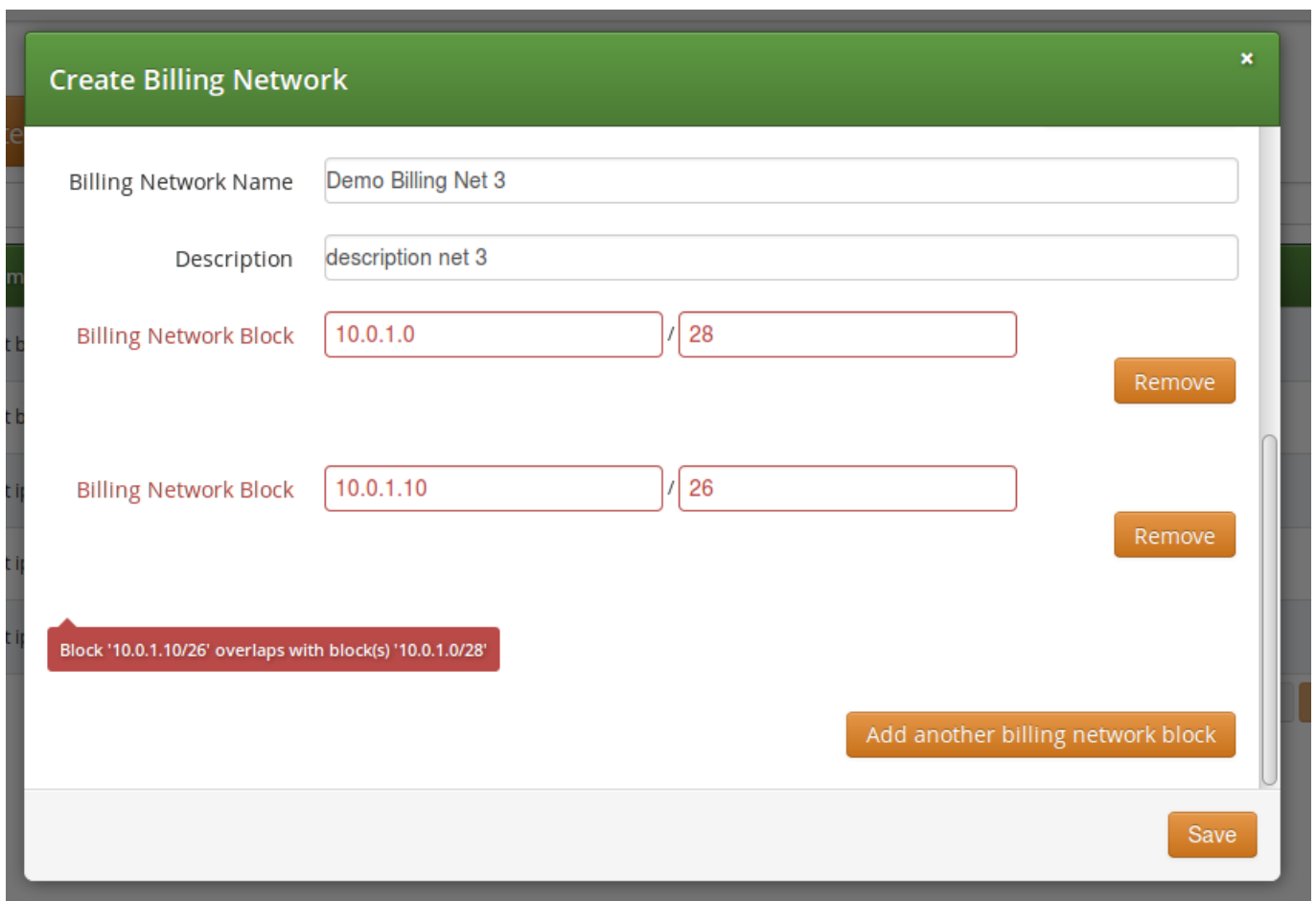

The screenshot shows a 'Create Billing Network' dialog box with the following fields and controls:

- Billing Network Name:** Demo Billing Net 3
- Description:** description net 3
- Billing Network Block 1:** 10.0.1.0 / 28 (with a 'Remove' button)
- Billing Network Block 2:** 10.0.1.10 / 26 (with a 'Remove' button)
- Error Message:** A red box at the bottom left states: "Block '10.0.1.10/26' overlaps with block(s) '10.0.1.0/28'".
- Buttons:** 'Add another billing network block' and 'Save'.

Figure 92: Overlapping Block Prevention

8.5.2 Profile Mapping Schedule

Using the default settings related to billing when creating a new *Reseller* or *Customer* on the administrative web panel results in applying the standard billing profile mapping schedule: the same billing profile is always used.

8.5.2.1 Definition of Profile Mapping Schedules

The idea of *billing profile mapping schedule* is to extend the billing mappings logic to utilize it as a schedule for billing profiles (and associated fees) for the *Customer* or *Reseller* contract. So far, billing mapping records provided only a history showing which profile was in effect at a given time in the past, which is for example required for delayed rating of calls.

Now it is also possible to define in advance, when specific billing profiles should become active in the future, e.g. to plan campaigns or special offers.

Billing profile mappings represent a schedule of overlapping time intervals with *Billing Profiles* and *Billing Networks*, which are assigned to (customer) contracts when creating or editing them.

Mapping intervals can be of type:

- open: no start time + no end time
- half-open:
 - left-open: no start time + definite end time
 - right-open: definite start time + no end time
- closed: definite start time + definite end time

8.5.2.2 Schedule Example

id	Billing Profile Interval Schedule Example	Mai 2015			Jun 2015										
		29	30	31	1	2	3	4	5	6	7	8	9	10	11
1	open: base/fallback (profile 1, no/any network)	[Active throughout the entire period]													
2	closed: (profile 2, network 1) from June, 2nd. – 4th.	[Active from June 2nd to 4th]													
3	right open: (profile 3, network 1) starting on June, 1st.	[Active from June 1st onwards]													
4	right open: (profile 4, network 2) starting on June, 1st.	[Active from June 1st onwards]													
5	closed: (profile 5, no/any network) from June, 3rd. – 10th.	[Active from June 3rd to 10th]													

Figure 93: Profile Mapping Schedule Example

Applying the profile mapping schedule shown in the above figure will result in billing profiles being active as provided in the table below.

Table 13: Active Billing Profiles

Time	Web Panel shows	Rating		
		Caller IP in Network 1	Caller IP in Network 2	Caller IP in other network
May 30	Profile 1	Profile 1	Profile 1	Profile 1
June 1	Profile 4	Profile 3	Profile 4	Profile 1
June 2	Profile 2	Profile 2	Profile 4	Profile 1
June 5	Profile 5	Profile 3	Profile 4	Profile 5

8.5.2.3 Configuration of Schedules

A Customer's default billing profile mapping can be changed to scheduled mappings when editing its properties, at the parameter "Set billing profiles", selecting: `schedule (billing mapping intervals)`

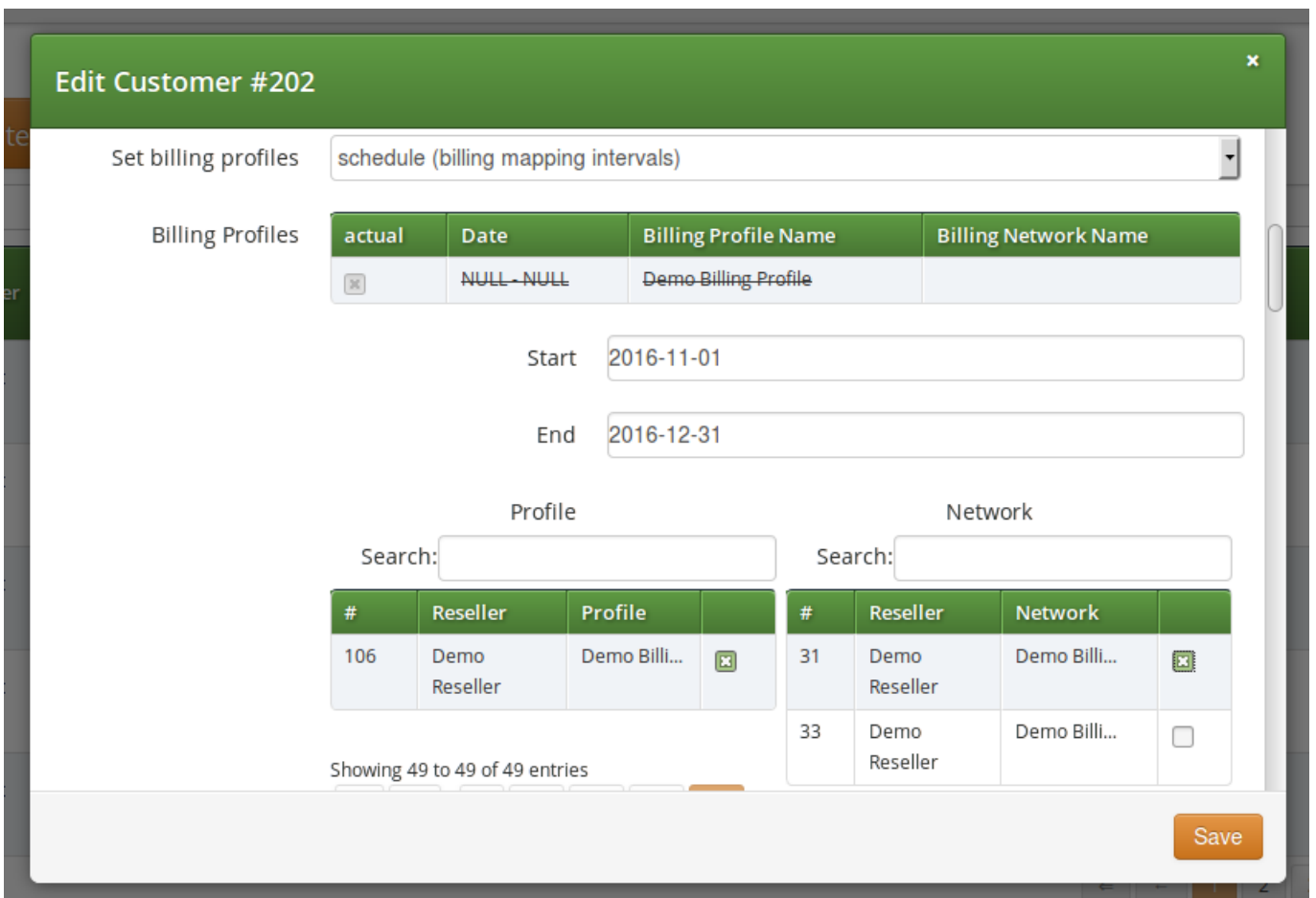

Figure 94: Profile Mapping Schedule Creation

Tip

Assigning a *Billing Network* to a billing profile mapping is optional. Without selecting the network, the *Billing Profile* will be applied to all calls.

The profile mapping schedule assigned to a *Customer* is also listed among *Customer's* properties. See *Settings* → *Customers* → *Details* → *Billing Profile Schedule*.

Customer Details for #202 (Cloud PBX Account)

← Back
☰ Preferences
✎ Edit

↕ Expand Groups

Reseller

Contact Details

Billing Profile Schedule

actual	Date	Billing Profile Name	Prepaid	Billing Network Name
<input checked="" type="checkbox"/>	NULL - NULL	Demo-Billing-Profile	<input type="checkbox"/>	
<input type="checkbox"/>	2016-11-01T00:00:00 - 2016-12-31T00:00:00	Demo Billing Profile	<input type="checkbox"/>	Demo Billing Net 1
<input type="checkbox"/>	2017-01-01T00:00:00 - 2017-12-31T00:00:00	Demo Billing Profile	<input type="checkbox"/>	

Subscribers

PBX Groups

Figure 95: Profile Mapping Schedule List

Note

Profile mappings that started in the past, like the default one, are displayed with a strike-through font in order to indicate that those can not be modified.

The currently active mapping is depicted by a checked box.

8.5.2.4 REST API for Profile Mapping Schedules

The `/api/customers/` API resource was extended to provide three different modes of defining profile mappings:

1. `billing_profiles` field: explicitly declare profile mappings in form of (billing profile, billing network, start time, stop time) tuples
2. `billing_profile_id` field (legacy API spec): a single profile mapping interval is appended (billing profile, no network / any caller IP respectively, starting now)

3. `profile_package_id` field: profile mappings starting now are appended by using lists of (`billing profile`, `billing network`) tuples from the given profile package

With regards to *Resellers*, the `/api/contracts/` API resource was enhanced as well, but supports method 1. and 2. only, and without billing networks.

Mapping Intervals

Intervals can be of open, half-open (left-open, right-open) or closed type. When specifying profile mappings discretely, allowed interval types are restricted, depending on create/update situation:

Table 14: Allowed Mapping Intervals

Interval Type	Start	Stop	POST (create)	PUT / PATCH (update)
open	undefined	undefined	1..*	0
left-open	undefined	defined	0	0
right-open	> now()	undefined	*	*
closed	> now()	> start	*	*

Example Profile Mapping

An example JSON structure for definition of profile mapping schedules shown in [Billing Profile Schedule List](#) :

```
{ ...,
  "billing_profile_definition" : "profiles", // i.e. use 'billing_profiles' field
  "billing_profiles" : [ { "network_id" : "236",
    "profile_id" : "236",
    "start" : "2016-11-01 00:00:00",
    "stop" : "2016-12-31 00:00:00"
  }, // closed future interval, with network
  { "network_id" : null,
    "profile_id" : "237",
    "start" : "2017-01-01 00:00:00",
    "stop" : "2017-12-31 00:00:00"
  } ], // closed future interval, without network
  "contact_id" : 141,
  ...
}
```

8.5.3 Profile Packages

By introducing billing profile packages, general billing parameters can be defined for a customer contract:

- Balance interval duration (regular/constant or aligned to top-up events)
- The first interval's start date
- The cash-balance carry-over/discard behaviour upon interval transitions
- Subscriber lock levels and profile sets to get applied upon:
 - top-up
 - balance threshold underrun
- Initial balance and billing profiles

Profile Packages are fundamental for pre-paid billing scenarios, since in such a billing scheme the traditional, fixed monthly periods prove to be insufficient to cover the business needs of Sipwise C5 platform operator. As an example: pre-paid subscribers typically have their "billing periods" between account balance top-ups.

8.5.3.1 Elements of Profile Packages

A *Profile Package* consists of various elements that will be discussed in subsequent sections of Sipwise C5 handbook. In order to set the parameters of a profile package one must navigate to: *Settings* → *Profile Packages* → *Create Profile Package*, or alternatively, in order to update an existing profile package: select the package and press *Edit* button.

Basic Balance Intervals Setup

- Interval duration (n hours, days, weeks, months)
- Interval start mode:
 - 1st of month (1st): billing interval is 1 calendar month; this is the default for each *Customer* created on Sipwise C5 platform

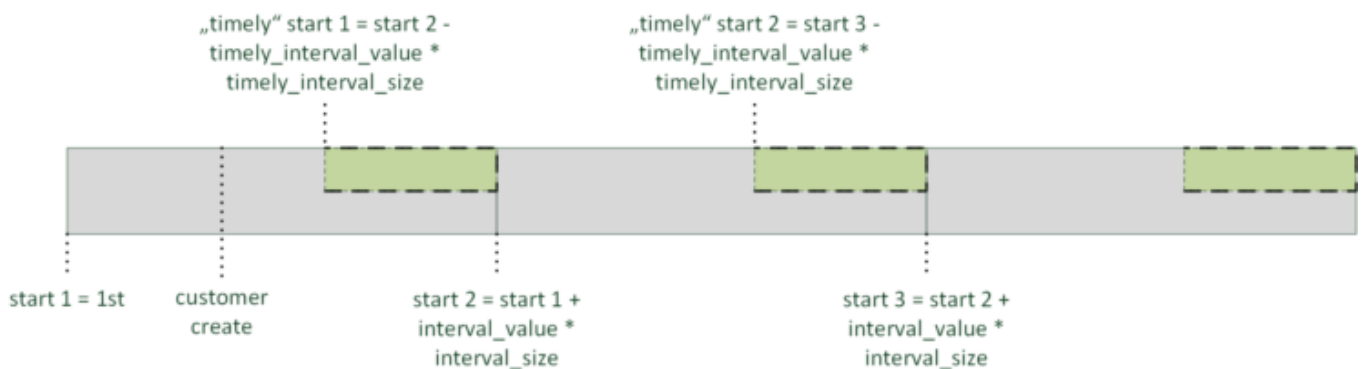

Figure 96: Interval Start Mode: 1st

- upon customer creation (create): (the initial) billing interval starts when the *Customer* is created

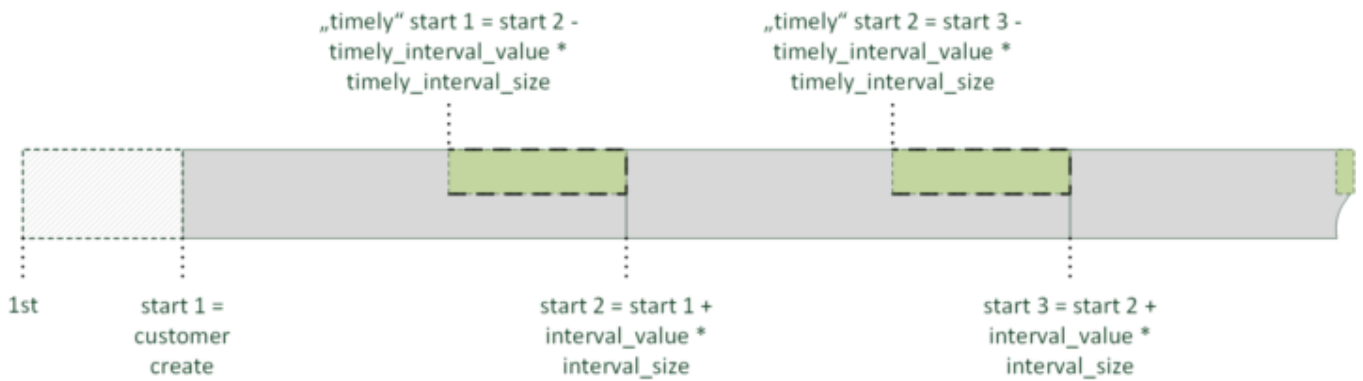

Figure 97: Interval Start Mode: create

- upon topup (topup_interval): interval starts at *first topup* event and its length is defined by `interval` duration parameter of the profile package

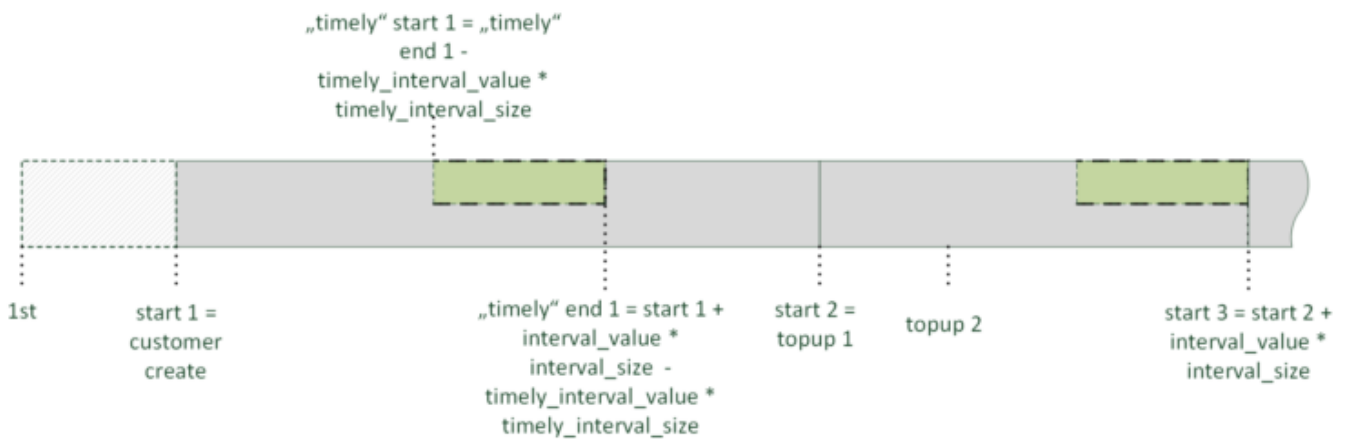

Figure 98: Interval Start Mode: topup_interval

- intervals from topup to topup (topup): interval starts at *any topup* event and its length is defined by `interval` duration parameter of the profile package; intervals can overlap in this case

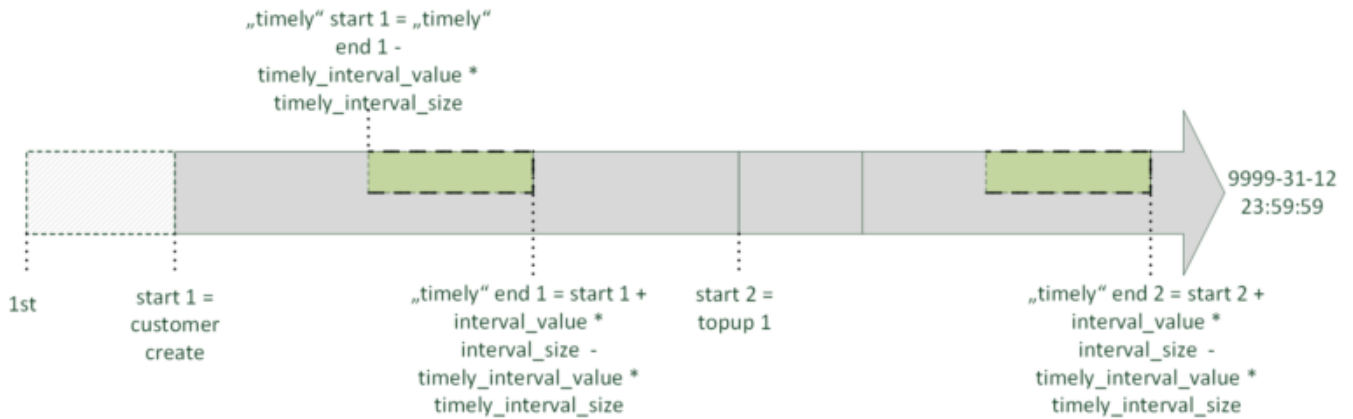

Figure 99: Interval Start Mode: topup

- Initial balance: the initial value of account balance (e.g. every new customer gets 5 Euros as a starting bonus)

Balance Carry Over

- Carry Over: balance carry over behaviour upon interval transitions:
 - `carry-over`: always keep balance
 - `carry-over only if topped-up timely`: keep balance in case of a *timely* top-up only; where **timely** means the topup happens within a pre-defined time span before the end of the balance interval
 - `discard`: discard balance at the end of each interval
- Timely Duration: duration of the *timely* period
- Discard balance after intervals: for how many balance intervals the remaining account balance is kept before its disposal

Underrun Settings

- Underrun lock threshold: when account balance reaches this amount the subscriber will be locked to a restricted set of services
- Underrun lock level: this level of services will apply when an account balance underruns
 - `don't change`: no change in the available set of services
 - `no lock`: all services are available
 - `foreign`: only calls within subscriber's own domain are allowed
 - `outgoing`: all outgoing calls are prohibited
 - `all calls`: all calls (incoming + outgoing) are prohibited
 - `global`: all calls + access to Customer Self Care web interface are prohibited
 - `ported`: only automatic call forwarding, due to number porting, is allowed
- Underrun profile threshold: when account balance reaches this amount the *Underrun Billing Profile* will be applied

Basic Top-up Settings

- Top-up lock level: subscriber lock (unlock) levels to apply upon top-up event
- Service charge: (always) subtract this value from the voucher amount, if topup happens via the usage of a voucher

Profile mappings

A lists of (billing profile, billing network) tuples for appending profile mappings:

- Initial Billing Profile: when creating or manually changing the customers package (initial_profiles)
- Underrun Billing Profile: when the balance underruns a cash threshold (underrun_profiles)
- Top-up Billing Profile: when the customer tops-up using a voucher associated with the package (topup_profiles)

8.5.3.2 Examples

Profile Package Configuration

1. Definition of basic profile package parameters

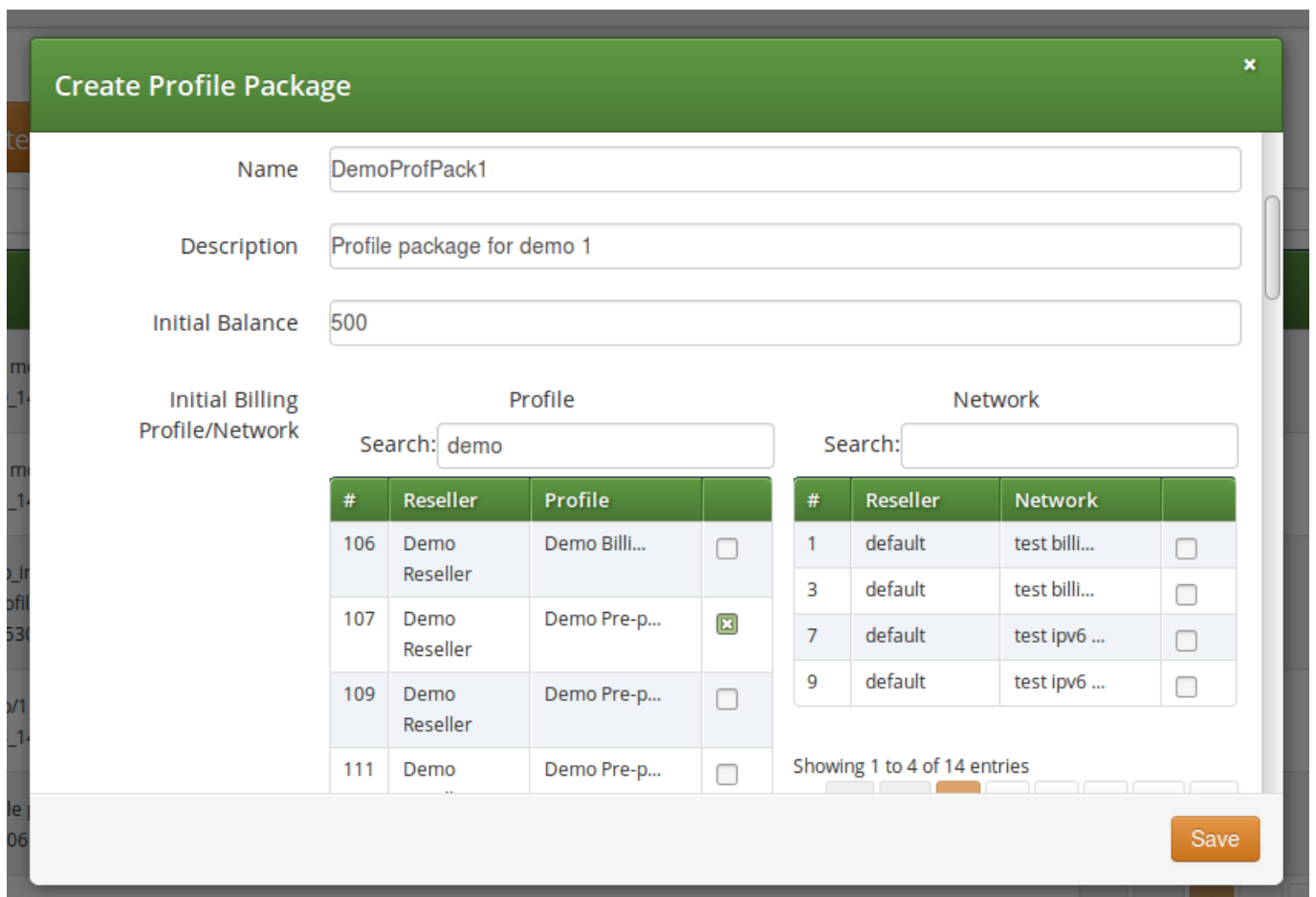
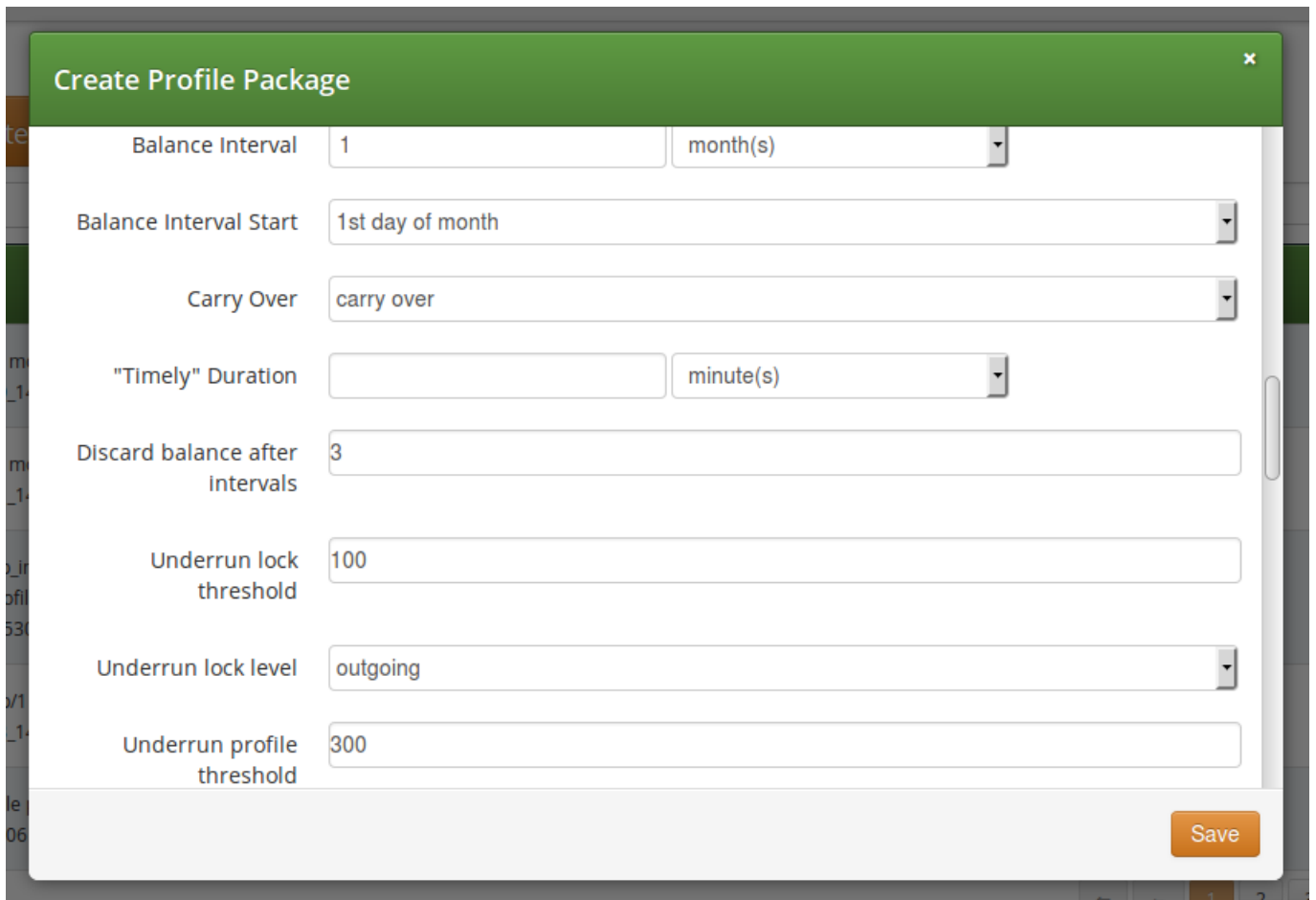

Figure 100: Basic Profile Package Parameters

2. Definition of balance interval and carry-over behaviour



The screenshot shows a 'Create Profile Package' dialog box with the following configuration options:

Parameter	Value
Balance Interval	1 month(s)
Balance Interval Start	1st day of month
Carry Over	carry over
"Timely" Duration	minute(s)
Discard balance after Intervals	3
Underrun lock threshold	100
Underrun lock level	outgoing
Underrun profile threshold	300

A 'Save' button is located at the bottom right of the dialog box.

Figure 101: Balance Interval and Carry-over

3. Definition of balance underrun parameters

Create Profile Package

Underrun lock threshold: 100

Underrun lock level: outgoing

Underrun profile threshold: 300

Underrun Billing Profile/Network

Profile				Network			
Search: demo				Search:			
#	Reseller	Profile	<input type="checkbox"/>	#	Reseller	Network	<input type="checkbox"/>
113	Demo Reseller	Demo Pre-p...	<input type="checkbox"/>	1	default	test billi...	<input type="checkbox"/>
115	Demo Reseller	Demo Pre-p...	<input checked="" type="checkbox"/>	3	default	test billi...	<input type="checkbox"/>
117	Demo Reseller	Demo Pre-p...	<input type="checkbox"/>	7	default	test ipv6 ...	<input type="checkbox"/>
				9	default	test ipv6 ...	<input type="checkbox"/>

Save

Figure 102: Balance Underrun Parameters

4. Definition of top-up settings

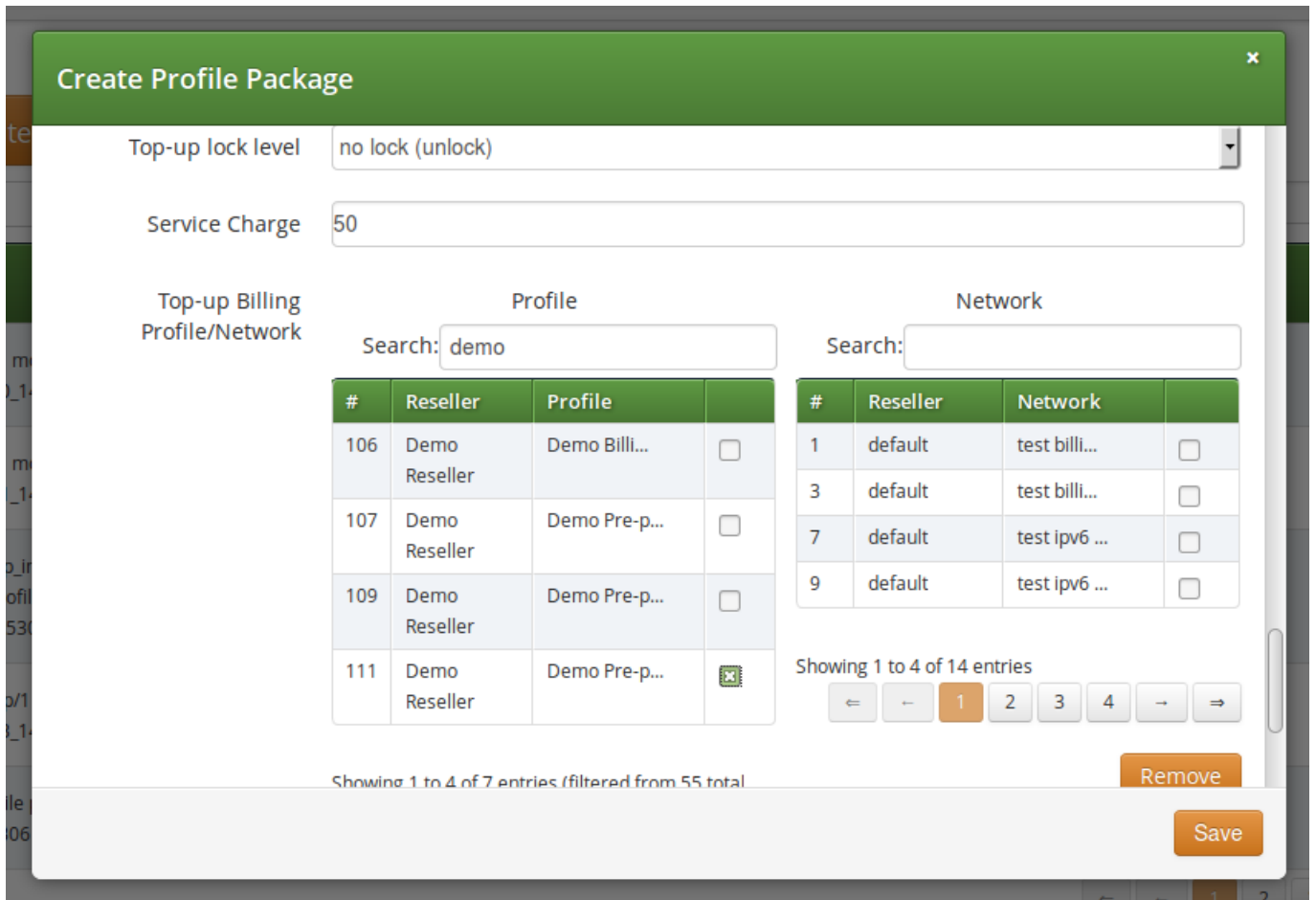

Figure 103: Balance Top-up Settings

5. Assigning a profile package to a customer

Edit Customer #197

Set billing profiles package (initial profiles of a profile package)

Package Search: demo

#	Reseller	Package	
67	Demo Reseller	DemoProfPack1	<input checked="" type="checkbox"/>
69	Demo Reseller	DemoProfpack2	<input type="checkbox"/>

Showing 1 to 2 of 2 entries (filtered from 32 total entries)

Create Profile Package

Product Search:

#	Name	
4	Basic SIP Account	<input checked="" type="checkbox"/>
5	Cloud PBX Account	<input type="checkbox"/>

Save

cust_contact0@custcontact.invalid Basic SIP SILVER NETWORK Y 1473815306 active

Figure 104: Assigning Profile Package to Customer

Interval start mode: top-up interval; carry-over: timely

Profile package setup:

- initial_balance: 1.0 euro
- balance_interval: 30 "day(s)"
- interval_start_mode: "topup_interval"
- carry_over_mode: "timely"
- timely_duration: 12 "day(s)"
- underrun_lock_threshold: 0.7 euro
- underrun_profile_threshold: 5.0 euro
- underrun_lock_level:...

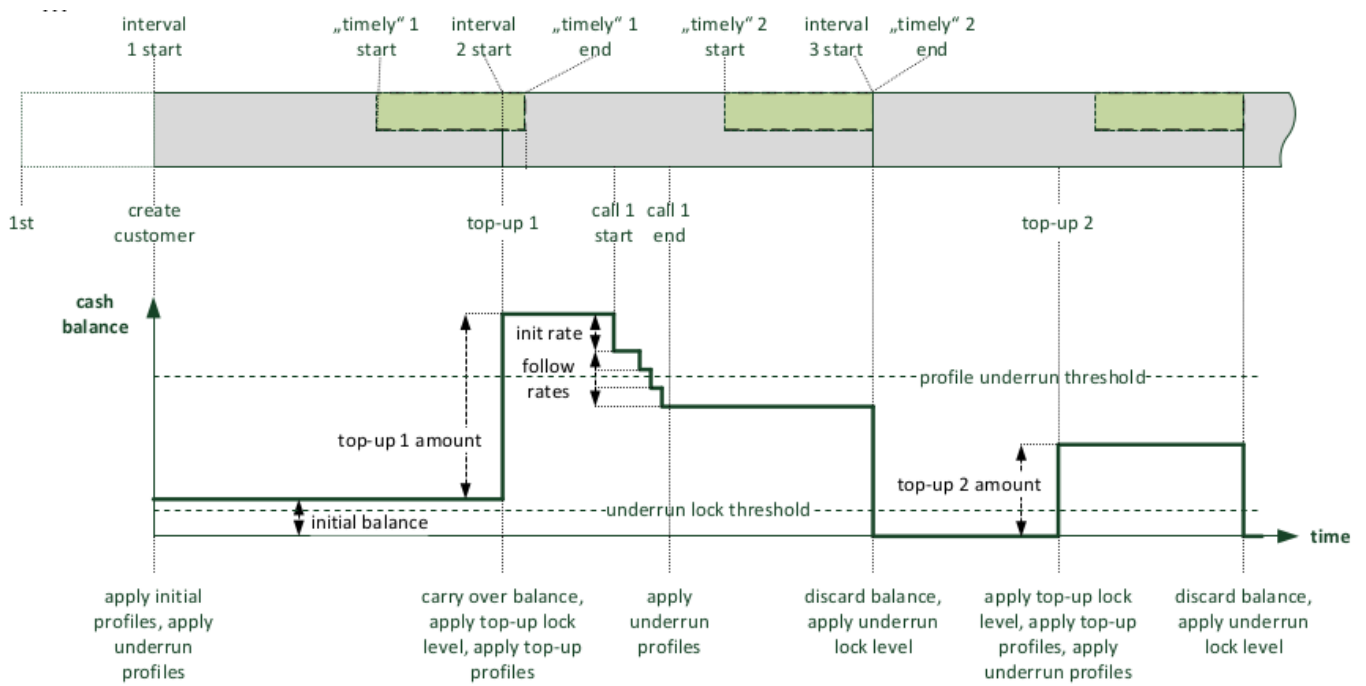

Figure 105: Example: Top-up Interval and Timely Carry-over

Interval start mode: top-up to top-up; carry-over: always

- initial_balance: 1.0 euro
- balance_interval: 30 "day(s)"
- interval_start_mode: "topup"
- carry_over_mode: "carry-over"
- notopup_discard_intervals: 1
- underrun_lock_threshold: 0.7 euro
- underrun_profile_threshold: 5.0 euro
- underrun_lock_level:...

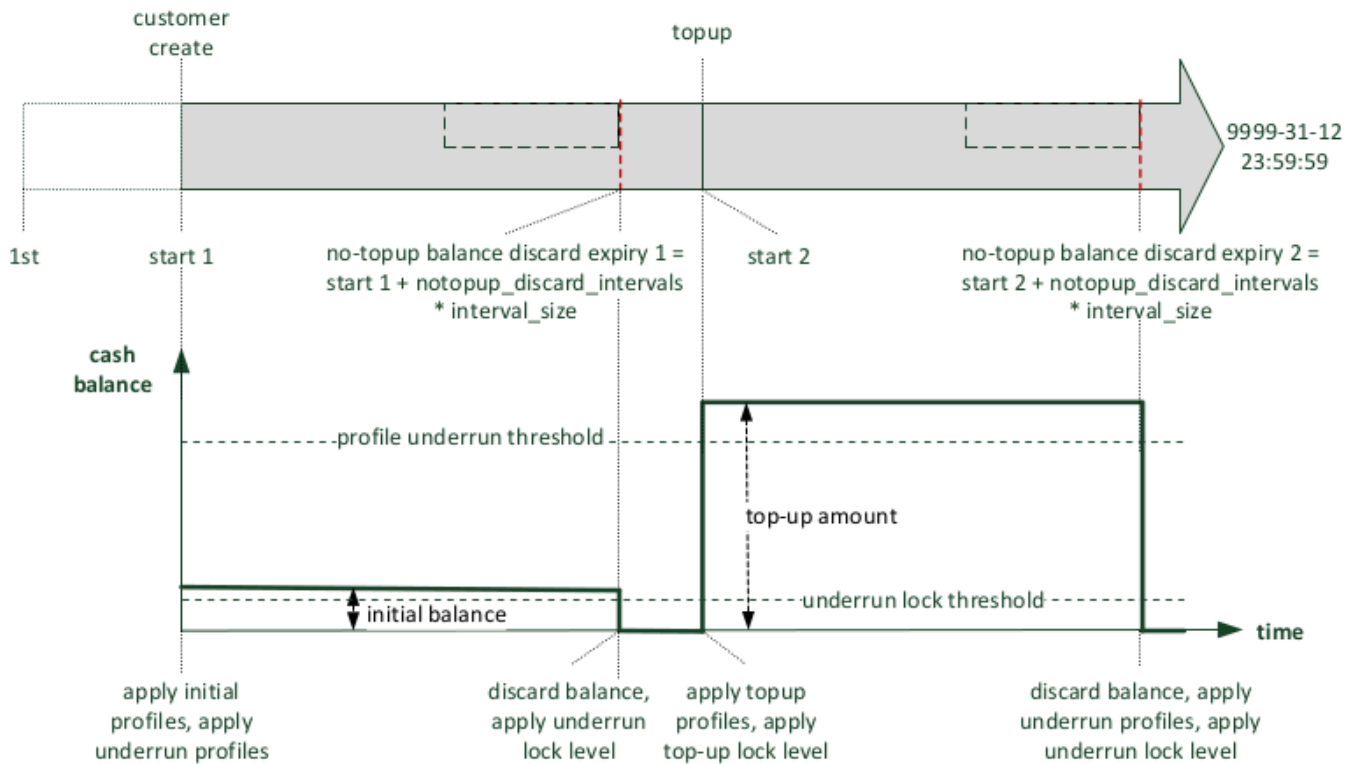

Figure 106: Example: Top-up and Always Carry-over

8.5.3.3 REST API

The new `/api/profilepackages/` REST API resource makes it possible to manage billing profile package container entities, that aggregate settings of profile packages.

A sample JSON structure follows:

```
{
  "reseller_id" : 1,
  "status" : "active",
  "name" : "demo profile package",
  "description" : "package for 10€ ...",
  "balance_interval_start_mode" : "1st",
  "balance_interval_value" : 1,
  "balance_interval_unit" : "month",
  "carry_over_mode" : "carry_over",
  "timely_duration_unit" : null,
  "timely_duration_value" : null,
  "initial_balance" : 0,
  "initial_profiles" : [...], // required default, e.g. same as „topup_profiles“
  "notopup_discard_intervals" : null,
  "underrun_lock_threshold" : 0,
}
```

```

"underrun_lock_level" : 4,
"underrun_profile_threshold" : 5,
"underrun_profiles" : [...],
"service_charge" : 10,
"topup_lock_level" : null,
"topup_profiles" : [ {
    "network_id" : null, // any network
    "profile_id" : 29
  },
  {
    "network_id" : 2, // a specific billing network
    "profile_id" : 30
  },
],
...
}
    
```

8.5.4 Vouchers

Vouchers are a typical mean of topping-up an account balance in pre-paid billing scenarios.

The definition of a voucher in the database may succeed via:

- manual entry of voucher data on the administrative web panel or through the REST API
- bulk-uploading of vouchers using a CSV (comma separated value) formatted file

In order to manage vouchers the administrator has to navigate to: *Settings* → *Vouchers* → *Create Billing Voucher* or select an existing one and press *Edit* button.

Billing Vouchers

← Back
★ Create Billing Voucher
★ Upload Vouchers as CSV

Billing voucher successfully created

Show entries
Search:

#~	Code	Amount	Reseller	Profile Package	For Contract #	Valid Until	Used At	Used By Subscriber #
25	DEMO_Voucher_Profpack1_001	1000	Demo Reseller	DemoProfPack1		2017-12-31 23:59:59		
27	DEMO_Voucher_Profpack2_001	2000	Demo Reseller	DemoProfpack2		2018-06-30 23:59:59		

Showing 1 to 2 of 2 entries (filtered from 14 total entries)

← → 1 → ⇒

Figure 107: List of Vouchers

8.5.4.1 Properties of Vouchers

- Code: the unique code of the voucher which assures that a voucher can be used only once; this property is encrypted and displayed on the web panel to authorized users only
- Amount: the amount of money the voucher represents
- Valid until: end of validity period

Create Billing Vouchers

Reseller Search:

#	Name	Contract #	Status
16	Demo Reseller	200	active

Showing 1 to 1 of 1 entries (filtered from 9 total entries)

Code

Amount

Valid until

Customer Search:

#	Reseller	Contact Email	External #	Status
---	----------	---------------	------------	--------

Figure 108: Voucher's Main Properties

Setting following properties of a voucher is optional:

- Customer: the *Customer* whom the voucher will be assigned to; subscribers of other customers can not redeem the voucher
- Package: vouchers may be associated with profile packages; if done so, some changes will be applied to the *Customer* for whom the voucher is redeemed with the top-up event:
 - applying top-up profile mappings starting with the time of the top-up
 - subtracting the new package's service charge from the voucher amount

- resizing the current balance interval for a gapless transition, if the new package has a different interval start mode (e.g. from "create" to "1st")
- if a new balance interval starts with the top-up, the carry-over mode of the customer's previous package applies

Create Billing Vouchers
✕

Customer

#	Reseller	Contact Email	External #	Status	
7	default	customer.test@spce.test		active	<input type="checkbox"/>
13	default	cust_contact0@custcontact.invalid		active	<input type="checkbox"/>
15	default	cust_contact0@custcontact.invalid		active	<input type="checkbox"/>
17	default	cust_contact0@custcontact.invalid		active	<input type="checkbox"/>

Showing 1 to 4 of 71 entries

← ← 1 2 3 4 5 ... → →

Create Contract

Search:

Package

#	Reseller	Package	
69	Demo Reseller	DemoProfpack2	<input type="checkbox"/>
67	Demo Reseller	DemoProfPack1	<input checked="" type="checkbox"/>

Search:

Save

Figure 109: Voucher: Customer and Profile Package

8.5.4.2 REST API

Vouchers can be created and managed using the `/api/vouchers/` REST API resource. This resource restricts invasive operations (POST, PUT, PATCH, DELETE) to authorized users.

```
{
  "amount" : 1000,
  "customer_id" : null, //do not restrict to a specific customer
  "valid_until" : "2017-06-05 23:59:59",
  "package_id" : "571", //switch to profile package
  "reseller_id" : 1,
  "code" : "SILVER_1_1437974823"
}
```

8.5.5 Top-up

A customer's administrator or subscriber can perform a top-up to increase the contract's cash balance. The Sipwise C5 platform supports two means of topping-up the balance:

1. Top-up Cash: Directly specify the cash amount to add
2. Top-up Voucher: Specify the code of a voucher, which was set up in advance

The Sipwise C5 platform provides 2 interfaces to perform top-ups:

1. through the REST API: use a CRM or third-party REST-API Broker (which i.e. coordinates with an App-Store purchase process) to finally instruct Sipwise C5 to perform a top-up. This is the **recommended** method.
2. through the administrative web interface:

One has to select the *Customer*, then *Details* → *Contract Balance* and finally press *Top-up Cash* or *Top-up Voucher*.

8.5.5.1 Top-up Cash

When doing top-up with cash one needs to supply the amount of top-up in the currency of the customer contract. Optionally one can assign a *Profile Package* to the top-up event which will activate that profile package for the customer.

Edit Settings ✕

Amount

Package Search:

#	Reseller	Package	
67	Demo Reseller	DemoProfPack1	<input checked="" type="checkbox"/>
69	Demo Reseller	DemoProfpack2	<input type="checkbox"/>

Showing 1 to 2 of 2 entries

← → 1 ← →

Create Profile Package

Perform top-up

Figure 110: Balance Top-up with Cash

It is also possible to perform top-up through the **REST API**: `POST /api/topupcash`

```
{
  "subscriber_id" : "73",
  "amount" : 100,
  "package_id" : null,
}
```

8.5.5.2 Top-up Voucher

Selecting *Top-up Voucher* option will provide a simple list of available vouchers from which the administrator can choose the voucher. If a *Profile Package* is assigned to the voucher, that package will be activated for the customer on the top-up event.

Edit Settings

Voucher Search:

#	Code	Amount	Reseller	Package	Used At	
25	DEMO_Voucher_Profpack1_001	1000	Demo Reseller	DemoProfPack1		<input checked="" type="checkbox"/>
27	DEMO_Voucher_Profpack2_001	2000	Demo Reseller	DemoProfpack2		<input type="checkbox"/>

Showing 1 to 2 of 2 entries ← 1 →

Perform top-up

Figure 111: Balance Top-up with Voucher

It is also possible to perform top-up through the **REST API**: `POST /api/topupvouchers`

```
{
  "subscriber_id" : "73",
  "code" : "SILVER_1_1437974390"
  "request_token" : "uuid_from_3rdparty_relay" // optional request identifier
  // for lookups in the top-up log
}
```

8.5.6 Balance Overviews

The actual contract balance and logs of top-up or balance interval change events are a kind of financially important information and that's why those are provided on the administrative web interface for each customer. One should navigate to: *Settings* → *Customers* → *select the customer* → *Details*.

The various information details available on the web interface are discussed in subsequent sections of the handbook.

8.5.6.1 Contract Balance

This part of the overviews shows the actual financial state of the customer's balance and the current profile package and balance interval.

Sound Sets

Contract Balance

↻ Top-up Voucher
↻ Top-up Cash
🔗 Set Cash Balance

Cash balance	11.50	Debit	0.00
Free time balance	0	Free time spent	0

Interval from	2016-10-01T00:00:00	Interval to	2016-10-31T23:59:59
"Timely" top-ups from		"Timely" top-ups to	
Balance will be discarded, if no top-up happens until		2017-02-01T00:00:00	

Actual profile package	DemoProfPack1	Actual billing profile	Demo Pre-paid Topup 1
Balance threshold when underrun profiles get applied	1.00	Balance threshold when subscribers will be locked	1.00

Balance Intervals

Top-up Log

Figure 112: Contract Balance Status

Another functionality assigned to *Contract Balance* section is the manual top-up. Both top-up with cash and top-up with voucher can be performed from here.

8.5.6.2 Balance Intervals

This table shows the balance intervals that have been in use, including the current interval.

Sound Sets							
Contract Balance							
Balance Intervals							
Show <input type="text" value="5"/> entries					Search: <input type="text"/>		
From	To	Cash	Debit	#Top-ups	#Timely Top-ups	Underrun detected (Profiles)	Underrun detected (Lock)
2016-09-01 00:00:00	2016-09-30 23:59:59	0.00	0.00	0	0		
2016-10-01 00:00:00	2016-10-31 23:59:59	11.50	0.00	1	0	2016-10-07 15:05:26	2016-10-07 15:05:26
Showing 1 to 2 of 2 entries							<input type="button" value="←"/> <input type="button" value="→"/> <input type="button" value="1"/> <input type="button" value="↔"/>
Top-up Log							
Fraud Limits							

Figure 113: List of Balance Intervals

Content of the balance intervals table is:

- From, To: starting and end points of the time interval
- Cash: the contract’s cash balance value at the end of the interval (former int.), or currently (actual int.)
- Debit: the total spent amount of money in the actual interval

Note

While "Cash" shows the remaining amount, "Debit" shows the spent amount. With a post-paid billing scenario only "Debit" field would be populated, with pre-paid both fields will display an amount.

- No. of Top-ups: how many top-up events happened within the interval
- No. of Timely Top-ups: how many timely top-up events happened within the interval
- Underrun detected (Profiles or Lock): the time of last underrun event when either an underrun billing profile, or a subscriber lock was activated

8.5.6.3 Top-up Log

Each successful or failing top-up request has to be logged. The log records represent an audit trail and reflect any data changes in the course of the top-up request.

In case of an error during the top-up operation the error message and any parseable fields of failed top-up attempts is recorded.

Contract Balance											
Balance Intervals											
Top-up Log											
Show	5	entries	From Date:	<input type="text"/>	To Date:	<input type="text"/>	Search:	<input type="text"/>			
Timestamp	Subscriber	Type	Outcome	Message	Voucher ID	Amount	Balance before	Balance after	Package before	Package after	
2016-10-07 15:11:29		cash	ok			11.50	0.00	11.50	DemoProfPack1	DemoProfPack1	
Showing 1 to 1 of 1 entries											<input type="button" value="←"/> <input type="button" value="--"/> <input type="button" value="1"/> <input type="button" value="--"/> <input type="button" value="→"/>
Fraud Limits											
Invoices											

Figure 114: Balance Top-up Log

Content of the top-up log table is:

- **Timestamp:** when the top-up happened
- **Subscriber:** the ID of the subscriber who performed the top-up
- **Type:** `cash` or `voucher`
- **Outcome:** `ok` or `failed`
- **Message:** error message, if Outcome="failed"
- **Voucher ID:** ID of voucher, if Type="voucher"
- **Amount:** the amount by which the balance was modified (after the *Service Charge* was subtracted from the voucher's value)
- **Balance before:** balance's value before top-up
- **Balance after:** balance's value after top-up
- **Package before:** the name of the *Profile Package* that was active before top-up
- **Package after:** the name of the *Profile Package* that became active after top-up

The top-up log table can also be queried using the readonly `/api/topuplogs` **REST API** resource.

An example of the response:

```
{
  "_embedded" : {
    "ngcp:topuplogs" : [{
      "_links" : {...},
      "amount" : null,
      "cash_balance_after" : null,

```

```

    "cash_balance_before" : null,
    "contract_balance_after_id" : null,
    "contract_balance_before_id" : null,
    "contract_id" : 2565,
    "id" : 373,
    "lock_level_after" : null,
    "lock_level_before" : null,
    "message" : ..., //error reason
    "outcome" : "failed",
    "package_after_id" : null,
    "package_before_id" : null,
    "profile_after_id" : null,
    "profile_before_id" : null,
    "request_token" : "1444956281_6", // = "panel" for panel UI requests
    "subscriber_id" : 1804,
    "timestamp" : "2015-10-16 02:45:19",
    "type" : "voucher", // "cash" or "voucher"
    "username" : "administrator",
    "voucher_id" : null }]
  },
  "_links" : { ... },
  "total_count" : 1
}

```

8.5.7 Usage Examples

After getting to know the concepts of customized billing solution on Sipwise C5 platform, it's worth seeing some practical examples for the usage of those advanced features.

The starting point is the setup of *Profile Packages* for our fictive customers: A, B and C. There are 4 different packages defined, with corresponding vouchers:

- **Initial:**

- Balance interval: 1 month
- Timely duration: 1 month
- Interval start mode: topup_interval
- Carry-over mode: carry_over_timely

- **Silver:**

- Balance interval: 1 month
- Timely duration: 1 month
- Interval start mode: "topup_interval"
- Carry-over mode: "carry_over_timely"

- Service charge: 2 EUR
- Underrun lock level: "no lock"
- Voucher value: 10 EUR

• **Gold:**

- Balance interval: 1 month
- Interval start mode: "topup_interval"
- Carry-over mode: "carry_over"
- Service charge: 5 EUR
- Underrun lock level: "no lock"
- Voucher value: 20 EUR

• **Extension:**

- Balance interval: 1 month
- Timely duration: 1 month
- Interval start mode: "topup_interval"
- Carry-over mode: "carry_over_timely"
- Service charge: 2 EUR
- Underrun lock level: "no lock"
- Voucher value: 2 EUR

8.5.7.1 Customer A — Silver Package

1. Customer A tops up 10 EUR with a "silver" voucher. 2 EUR are deducted as service charge. Remaining balance is 8 EUR starting on the date of the top-up.
2. Customer A doesn't top-up balance within the next month, so remaining balance is set to 0 after one month, and billing profiles and lock levels are set to the balance-underrun definition of the "silver" package.

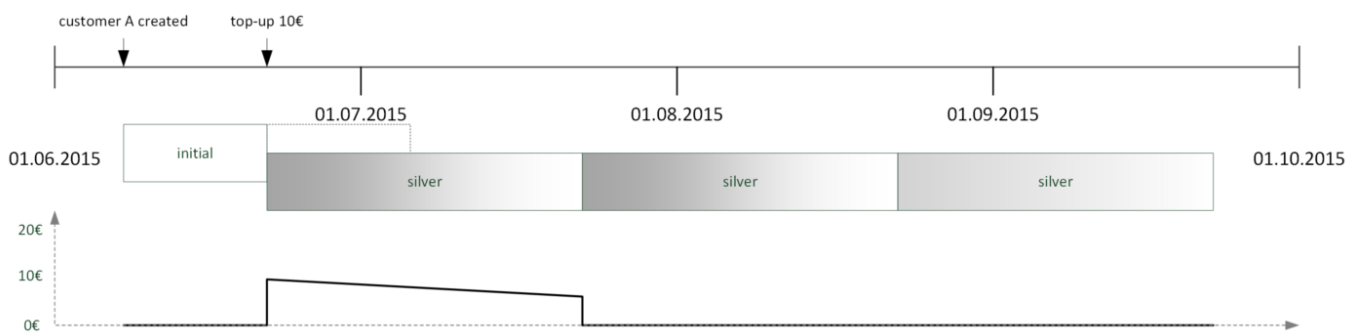

Figure 115: Usage Example: Silver Package

8.5.7.2 Customer B—Silver and Extension Package

1. Customer B tops up 10 EUR with the “silver” voucher. 2 EUR are deducted as service charge. Remaining balance is 8 EUR starting on the date of the top-up.
2. Customer B tops up 2 EUR using an “extension” voucher on the last day. 2 EUR are deducted as service charge and the interval is extended for one month, carrying over his old balance.
3. Customer B doesn’t top-up balance within the next month, so remaining balance is set to 0 after the month, and billing profiles and lock levels are set to the balance-underrun definition of the “extension” package.

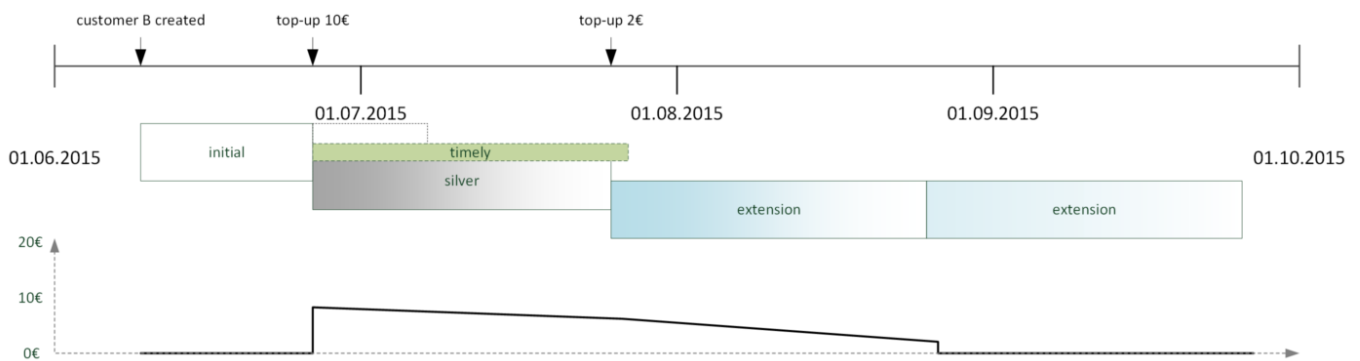

Figure 116: Usage Example: Silver + Extension Package

8.5.7.3 Customer C—Gold Package

Customer C tops up 20 EUR with the “gold” voucher. 5 EUR are deducted as service charge. Remaining balance is 15 EUR starting on the date of the top-up. Balance is carried over after each month until used up.

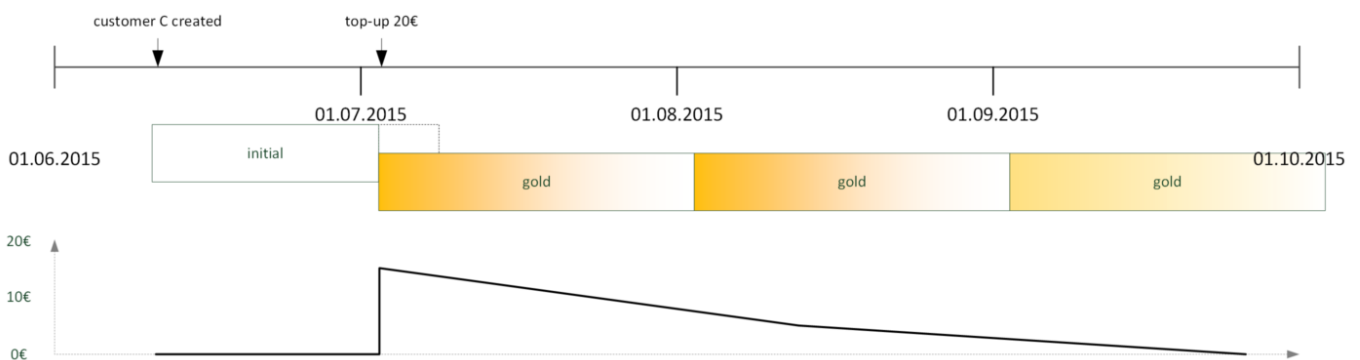

Figure 117: Usage Example: Gold Package

8.6 Notes on Billing and Call Rating

Cash balance with post-paid billing profile

Customers with a post-paid billing profile may have a positive account cash balance value. This is the regular case when using a post-paid billing profile showing a *free cash* greater than 0.

Tip

You can set the free cash (and the free time) in the billing profile. The account balance will be set and managed (i.e. refilled or carried over) automatically for subsequent balance intervals.

In case the account has a positive cash balance, the cost of the call will be deducted from that balance and not considered as additional cost of that particular call for the customer.

**Important**

The rating engine (*ngcp-rate-o-mat*) in Sipwise C5 will write 0 instead of the real cost of a call in the CDR, if the source customer's (who initiated the call) account has a positive cash balance! The purpose of this is to reflect the usage of free cash in the CDR for the particular call.

Note

It might happen, for instance, that a customer's billing profile is changed from pre-paid to post-paid, and the customer already had a positive cash balance on his account. In that case the same call rating mechanism is involved as for the free cash.

8.7 Billing Data Export

Regular billing data export is done using CSV (*comma separated values*) files which may be downloaded from the platform using the *cdrexpert* user which has been created during the installation.

There are two types of exports. One is *CDR* (Call Detail Records) used to charge for calls made by subscribers, and the other is *EDR* (Event Detail Records) used to charge for provisioning events like enabling certain features.

8.7.1 Glossary of Terms

Billing records contain fields that hold data of various entities that play a role in the phone service offered by Sipwise C5. For a better understanding of billing data please refer to the glossary provided here:

- **Account:** the customer's account that is charged for calls of its subscriber(s)
- **Carrier:** a SIP peer that sends incoming calls to, or receives outgoing calls from NGCP. A carrier may charge fees for the outgoing calls from Sipwise C5 (outbound billing fee), or for the incoming calls to Sipwise C5 (inbound billing fee).
- **Contract:** the service contract that represents a customer, a reseller or a SIP peer; a contract on Sipwise C5 contains the billing profile (billing fees) too
- **Customer:** the legal entity that represents any number of subscribers; this entity receives the bills for calls of its subscriber(s)
- **Provider:** either the reseller that holds a subscriber who is registered on NGCP, or the SIP peer that handles calls between an external subscriber and NGCP

- **Reseller:** the entity who is the direct, administrative service provider of a group of customers and subscribers registered on NGCP; Sipwise C5 operator may also charge a reseller for the calls initiated or received by its subscribers
- **User:** the subscriber who either is registered on NGCP, or is an external call party

8.7.2 File Name Format

In order to be able to easily identify billing files, the file names are constructed by the following fixed-length fields:

```
<prefix><separator><version><separator><timestamp><separator><sequence number>< ←
  suffix>
```

The definition of the specific fields is as follows:

Table 15: CDR/EDR export file name format

File name element	Length	Description
<prefix>	7	A fixed string. Always sipwise.
<separator>	1	A fixed character. Always _.
<version>	3	The format version, a three digit number. Currently 007.
<timestamp>	14	The file creation timestamp in the format YYYYMMDDhhmmss.
<sequence number>	10	A unique 10-digit zero-padded sequence number for quick identification.
<suffix>	4	A fixed string. Always .cdr or .edr.

A valid example filename for a CDR billing file created at 2012-03-10 14:30:00 and being the 42nd file exported by the system, is:

```
sipwise_007_20130310143000_0000000042.cdr
```

8.7.3 File Format

Each billing file consists of three parts: one header line, zero to 5000 body lines and one trailer line.

8.7.3.1 File Header Format

The billing file header is one single line, which is constructed by the following fields:

```
<version>,<number of records>
```

The definition of the specific fields is as follows:

Table 16: CDR/EDR export file header line format

Body Element	Length	Type	Description
<version>	3	zero-padded uint	The format version. Currently 007.
<number of records>	4	zero-padded uint	The number of body lines contained in the file.

A valid example for a Header is:

```
007,0738
```

8.7.3.2 File Body Format for Call Detail Records (CDR)

The body of a CDR consists of a minimum of zero and a default maximum of 5000 lines. The platform operator can configure the maximum number of lines kept in a file by updating the `cdrexport.max_rows_per_file` parameter in `/etc/ngcp-config/cdr` file. Each line holds one call detail record in CSV format and is constructed by a configurable set of fields, all of them enclosed in single quotes.

The following table defines the **default set of fields** that are inserted into the CDR file, for exports related to *system* scope. The list of fields is defined in `/etc/ngcp-config/config.yml` file, `cdrexport.admin_export_fields` parameter.

Table 17: Default set of system CDR fields

Body Element	Length	Type	Description
CDR_ID	1-10	uint	Internal CDR ID.
UPDATE_TIME	19	timestamp	Timestamp of last modification, including date and time (with seconds precision).
SOURCE_USER_ID	36	string	Internal UUID of calling party subscriber. Value is 0 if calling party is external.
SOURCE_PROVIDER_ID	0-255	string	Internal ID of the contract of calling party provider (i.e. reseller or peer).

Table 17: (continued)

Body Element	Length	Type	Description
SOURCE_EXTERNAL_SUBSCRIBER_ID	0-255	string	External, arbitrary ID of calling party subscriber. (A string value shown as "External ID" property of an Sipwise C5 subscriber.)
SOURCE_SUBSCRIBER_ID	1-11	uint	Internal ID of calling party subscriber. Value is 0 if calling party is external.
SOURCE_EXTERNAL_CONTRACT_ID	0-255	string	External, arbitrary ID of calling party customer. (A string value shown as "External ID" property of an Sipwise C5 customer/peer.)
SOURCE_ACCOUNT_ID	1-11	uint	Internal ID of calling party customer.
SOURCE_USER	0-255	string	SIP username of calling party.
SOURCE_DOMAIN	0-255	string	SIP domain of calling party.
SOURCE_CLI	0-64	string	CLI of calling party in E.164 format.
SOURCE_CLIR	1	uint	1 for calls with CLIR, 0 otherwise.
SOURCE_IP	0-64	string	IP Address of the calling party.
DESTINATION_USER_ID	36	string	Internal UUID of called party subscriber. Value is 0 if called party is external.
DESTINATION_PROVIDER_ID	0-255	string	Internal ID of the contract of called party provider (i.e. reseller or peer).
DESTINATION_EXTERNAL_SUBSCRIBER_ID	0-255	string	External, arbitrary ID of called party subscriber. (A string value shown as "External ID" property of an Sipwise C5 subscriber.)
DESTINATION_SUBSCRIBER_ID	1-11	uint	Internal ID of called party subscriber. Value is 0 if calling party is external.
DESTINATION_EXTERNAL_CONTRACT_ID	0-255	string	External, arbitrary ID of called party customer. (A string value shown as "External ID" property of an Sipwise C5 customer/peer.)
DESTINATION_ACCOUNT_ID	1-11	uint	Internal ID of called party customer.
DESTINATION_USER	0-255	string	Final SIP username of called party.
DESTINATION_DOMAIN	0-255	string	Final SIP domain of called party.
DESTINATION_USER_IN	0-255	string	Incoming SIP username of called party, after applying inbound rewrite rules.
DESTINATION_DOMAIN_IN	0-255	string	Incoming SIP domain of called party, after applying inbound rewrite rules.
DESTINATION_USER_DIALED	0-255	string	The user-part of the SIP Request URI as received by NGCP.

Table 17: (continued)

Body Element	Length	Type	Description
PEER_AUTH_USER	0-255	string	Username used to authenticate towards peer.
PEER_AUTH_REALM	0-255	string	Realm used to authenticate towards peer.
CALL_TYPE	3-4	string	The type of the call - one of: call: normal call cfu: call forward unconditional cfb: call forward busy cft: call forward timeout cfna: call forward not available cfs: call forward for SMS cfr: call forward on response cfo: call forward on overflow
CALL_STATUS	2-8	string	The final call status - one of: ok: successful call busy: called party busy noanswer: no answer from called party cancel: cancel from caller offline called party offline timeout: no reply from called party other: unspecified, see CALL_CODE field for details
CALL_CODE	3	string	The final SIP status code.
INIT_TIME	23	timestamp	Timestamp of call initiation (SIP <i>INVITE</i> received from calling party). Includes date, time with milliseconds (3 decimals).
START_TIME	23	timestamp	Timestamp of call establishment (final SIP response received from called party). Includes date, time with milliseconds (3 decimals).
DURATION	4-13	fixed precision (3 decimals)	Length of call (calculated from START_TIME) including milliseconds (3 decimals).
END_TIME	23	timestamp	START_TIME plus DURATION.
INIT_TIME_TRUNCATED	19	timestamp	INIT_TIME without milliseconds.
START_TIME_TRUNCATED	19	timestamp	START_TIME without milliseconds.
END_TIME_TRUNCATED	19	timestamp	END_TIME without milliseconds.

Table 17: (continued)

Body Element	Length	Type	Description
TIMEZONE	100	string	The name of the local subscriber's active timezone, defined by the contact of the subscriber/contract/reseller. The caller's timezone is used for outgoing calls. For calls from external subscribers, the callee's timezone is used. System timezone (defined in config.yml) is used for transit calls.
INIT_TIME_LOCALIZED	23	timestamp	INIT_TIME, converted to TIMEZONE.
START_TIME_LOCALIZED	23	timestamp	START_TIME, converted to TIMEZONE.
END_TIME_LOCALIZED	23	timestamp	END_TIME, converted to TIMEZONE.
INIT_TIME_LOCALIZED_TRUNCATED	19	timestamp	INIT_TIME_LOCALIZED without milliseconds.
START_TIME_LOCALIZED_TRUNCATED	19	timestamp	START_TIME_LOCALIZED without milliseconds.
END_TIME_LOCALIZED_TRUNCATED	19	timestamp	END_TIME_LOCALIZED without milliseconds.
CALL_ID	0-255	string	The SIP Call-ID.
RATING_STATUS	2-7	string	The internal rating status of the CDR - one of: unrated: not rated ok: successfully rated failed: error while rating Currently always ok or unrated, depending on whether rating is enabled or not.
RATED_AT	0-19	datetime	Time of rating, including date and time (with seconds precision). Empty if CDR is not rated.
SOURCE_CARRIER_COST	7-14	fixed precision (6 decimals)	The originating carrier cost that the carrier (i.e. SIP peer) charges for the calls routed to his network, or empty if CDR is not rated. <i>PLEASE NOTE: Only available in system exports, not for resellers.</i>
SOURCE_CUSTOMER_COST	7-14	fixed precision (6 decimals)	The originating customer cost, or empty if CDR is not rated.

Table 17: (continued)

Body Element	Length	Type	Description
SOURCE_CARRIER_ZONE	0-127	string	Name of the originating carrier billing zone, or <code>onnet</code> if data is not available. <i>PLEASE NOTE: Only available in system exports, not for resellers.</i>
SOURCE_CUSTOMER_ZONE	0-127	string	Name of the originating customer billing zone, or empty if CDR is not rated.
SOURCE_CARRIER_DETAIL	0-127	string	Description of the originating carrier billing zone, or <code>platform internal</code> if data is not available. <i>PLEASE NOTE: Only available in system exports, not for resellers.</i>
SOURCE_CUSTOMER_DETAIL	0-127	string	Description of the originating customer billing zone, or empty if CDR is not rated.
SOURCE_CARRIER_FREE_TIME	1-10	uint	The number of free time seconds used on originating carrier side, or empty if CDR is not rated. <i>PLEASE NOTE: Only available in system exports, not for resellers.</i>
SOURCE_CUSTOMER_FREE_TIME	1-10	uint	The number of free time seconds used from the originating customer's account balance, or empty if CDR is not rated.
DESTINATION_CARRIER_COST	7-14	fixed precision (6 decimals)	The terminating carrier cost, or empty if CDR is not rated. <i>PLEASE NOTE: Only available in system exports, not for resellers.</i>
DESTINATION_CUSTOMER_COST	7-14	fixed precision (6 decimals)	The terminating customer cost, or empty if CDR is not rated.
DESTINATION_CARRIER_ZONE	0-127	string	Name of the terminating carrier billing zone, or <code>onnet</code> if data is not available. <i>PLEASE NOTE: Only available in system exports, not for resellers.</i>
DESTINATION_CUSTOMER_ZONE	0-127	string	Name of the terminating customer billing zone, or empty if CDR is not rated.
DESTINATION_CARRIER_DETAIL	0-127	string	Description of the terminating carrier billing zone, or empty if CDR is not rated. <i>PLEASE NOTE: Only available in system exports, not for resellers.</i>

Table 17: (continued)

Body Element	Length	Type	Description
DESTINATION_CUSTOMER_DETAIL	0-127	string	Description of the terminating customer billing zone, or empty if CDR is not rated.
DESTINATION_CARRIER_FREE_TIME	1-10	uint	The number of free time seconds used on terminating carrier side, or empty if CDR is not rated. <i>PLEASE NOTE: Only available in system exports, not for resellers.</i>
DESTINATION_CUSTOMER_FREE_TIME	1-10	uint	The number of free time seconds used from the terminating customer's account balance, or empty if CDR is not rated.
SOURCE_RESELLER_COST	7-14	fixed precision (6 decimals)	The originating reseller cost, or empty if CDR is not rated. <i>PLEASE NOTE: Only available in system exports, not for resellers.</i>
SOURCE_RESELLER_ZONE	0-127	string	Name of the originating reseller billing zone, or empty if CDR is not rated. <i>PLEASE NOTE: Only available in system exports, not for resellers.</i>
SOURCE_RESELLER_DETAIL	0-127	string	Description of the originating reseller billing zone, or empty if CDR is not rated. <i>PLEASE NOTE: Only available in system exports, not for resellers.</i>
SOURCE_RESELLER_FREE_TIME	1-10	uint	The number of free time seconds used from the originating reseller's account balance, or empty if CDR is not rated. <i>PLEASE NOTE: Only available in system exports, not for resellers.</i>
DESTINATION_RESELLER_COST	7-14	fixed precision (6 decimals)	The terminating reseller cost, or empty if CDR is not rated. <i>PLEASE NOTE: Only available in system exports, not for resellers.</i>
DESTINATION_RESELLER_ZONE	0-127	string	Name of the terminating reseller billing zone, or empty if CDR is not rated. <i>PLEASE NOTE: Only available in system exports, not for resellers.</i>

Table 17: (continued)

Body Element	Length	Type	Description
DESTINATION_RESELLER_DETAIL	0-127	string	Description of the terminating reseller billing zone, or empty if CDR is not rated. <i>PLEASE NOTE: Only available in system exports, not for resellers.</i>
DESTINATION_RESELLER_FREE_TIME	1-10	uint	The number of free time seconds used from the terminating reseller's account balance, or empty if CDR is not rated. <i>PLEASE NOTE: Only available in system exports, not for resellers.</i>
<line_terminator>	1	string	Always \n (special char LF - ASCII 0x0A).

A valid example of one body line of a rated CDR is (line breaks added for clarity):

```
'15','2013-03-26 22:09:11','a84508a8-d256-4c80-a84e-820099a827b0','1','','1','','',
'2','testuser1','192.168.51.133','4311001','0','192.168.51.1',
'94d85b63-8f4b-43f0-b3b0-221c9e3373f2','','3','','4','testuser3',
'192.168.51.133','testuser3','192.168.51.133','testuser3','','','call','ok','200',
'2013-03-25 20:24:50.890','2013-03-25 20:24:51.460','10.880','44449842',
'ok','2013-03-25 20:25:27','0.00','24.00','onnet','testzone','platform internal',
'testzone','0','0','0.00','200.00','','foo','','foo','0','0',
'0.00','','','0','0.00','','','0'
```

The format of the **CDR export files generated for resellers** (as opposed to the complete system-wide export) is identical except for a few missing fields.

Note

Please check the description of fields in the table above, in order to see which fields are omitted for *reseller* related CDR exports.

The list of fields for *reseller* CDR export is defined in `/etc/ngcp-config/config.yml` file, `cdrexport.reseller_export_` parameter.

8.7.3.3 Extra fields that can be exported to CDRs

Supplementary Data

There are fields in CDR database that contain **supplementary data** related to subscribers. This data is not used by Sipwise C5 for CDR processing but rather provides the system administrator with a possibility to include supplementary information in CDRs.

Note

This informational section is meant for problem solving / debugging purpose: The supplementary data listed in following table is stored in `provisioning.voip_preferences` database table.

Table 18: Supplementary data in CDR fields

Body Element	Length	Type	Description
SOURCE_GPP0	0-255	string	Supplementary data field 0 of calling party.
SOURCE_GPP1	0-255	string	Supplementary data field 1 of calling party.
SOURCE_GPP2	0-255	string	Supplementary data field 2 of calling party.
SOURCE_GPP3	0-255	string	Supplementary data field 3 of calling party.
SOURCE_GPP4	0-255	string	Supplementary data field 4 of calling party.
SOURCE_GPP5	0-255	string	Supplementary data field 5 of calling party.
SOURCE_GPP6	0-255	string	Supplementary data field 6 of calling party.
SOURCE_GPP7	0-255	string	Supplementary data field 7 of calling party.
SOURCE_GPP8	0-255	string	Supplementary data field 8 of calling party.
SOURCE_GPP9	0-255	string	Supplementary data field 9 of calling party.
DESTINATION_GPP0	0-255	string	Supplementary data field 0 of called party.
DESTINATION_GPP1	0-255	string	Supplementary data field 1 of called party.
DESTINATION_GPP2	0-255	string	Supplementary data field 2 of called party.
DESTINATION_GPP3	0-255	string	Supplementary data field 3 of called party.
DESTINATION_GPP4	0-255	string	Supplementary data field 4 of called party.
DESTINATION_GPP5	0-255	string	Supplementary data field 5 of called party.
DESTINATION_GPP6	0-255	string	Supplementary data field 6 of called party.
DESTINATION_GPP7	0-255	string	Supplementary data field 7 of called party.
DESTINATION_GPP8	0-255	string	Supplementary data field 8 of called party.
DESTINATION_GPP9	0-255	string	Supplementary data field 9 of called party.

Account balance details (prepaid calls)

There are fields in CDR database that show **changes in cash or free time balance**. In addition to that, a history of billing packages / profiles may also be present, since Sipwise C5 vouchers, that are used to top-up, may also be set up to cause a transition of profile packages. (Which in turn can result in changing the billing profile/applicable fees). Therefore the billing package and profile valid at the time of the CDR are recorded and exposed as fields for CDR export.

Tip

Such fields may also be required to integrate Sipwise C5 with legacy billing systems.

Note

Please be aware that pre-paid billing functionality is only available in *Sipwise C5 PRO* and *Sipwise C5 CARRIER* products.

The name of CDR data field consists of the elements listed below:

1. `source|destination`: decides if the data refers to calling (source) or called (destination) party
2. `carrier|reseller|customer`: the account owner, whose billing data is referred
3. data type:
 - A. `cash_balance|free_time_balance _ before|after`: cash balance or free time balance, before or after the call
 - B. `profile_package_id|contract_balance_id`: internal ID of the active pre-paid billing profile or the account balance

Examples:

- `source_customer_cash_balance_before`
- `destination_customer_profile_package_id`

**Important**

For calls spanning multiple balance intervals, the latter one will be selected, that is the balance interval where the call ended.

**Important**

There are some limitations in rating **pre-paid** calls, please visit [Pre-paid Billing](#) section for details.

8.7.3.4 Distinguish between on-net and off-net calls CDRs

On-net calls (made only between devices on your network) are sometimes treated differently from off-net calls (terminated to or received from a peer) in external billing systems.

To distinguish between on-net and off-net calls in such a billing systems, check the **source_user_id** and **destination_user_id** fields. For on-net calls, both fields will have a different from zero value (actually, a UUID).

8.7.3.5 File Body Format for Event Detail Records (EDR)

The body of an EDR consists of a minimum of zero and a maximum of 5000 lines. The platform operator can configure the maximum number of lines kept in a file by updating the `eventexport.max_rows_per_file` parameter in `/etc/ngcp-config/con` file. Each line holds one call detail record in CSV format and is constructed by the fields as per the subsequent table.

The following table defines the **default set of fields** that are inserted into the EDR file, for exports related to *system* scope. The list of fields is defined in `/etc/ngcp-config/config.yml` file, `eventexport.admin_export_fields` parameter.

Table 19: Default set of system EDR fields

Body Element	Length	Type	Description
EVENT_ID	1-11	uint	Internal EDR ID.
TYPE	0-255	string	The type of the event - one of: <i>start_profile</i> : A subscriber profile has been newly assigned to a subscriber. <i>end_profile</i> : A subscriber profile has been removed from a subscriber. <i>update_profile</i> : A subscriber profile has been changed for a subscriber. <i>start_huntgroup</i> : A subscriber has been provisioned as PBX / hunting group. <i>end_huntgroup</i> : A subscriber has been deprovisioned as PBX / hunting group. <i>start_ivr</i> : A subscriber has a new call-forward to Auto-Attendant. <i>end_ivr</i> : A subscriber has removed a call-forward to Auto-Attendant.
CONTRACT_EXTERNAL_ID	0-255	string	The external ID of the customer. (A string value shown as "External ID" property of an Sipwise C5 customer.)
COMPANY	0-127	string	The company name of the customer's contact.
SUBSCRIBER_EXTERNAL_ID	0-255	string	The external ID of the subscriber. (A string value shown as "External ID" property of an Sipwise C5 subscriber.) <i>PLEASE NOTE: This field is empty in case of start_huntgroup and end_huntgroup events.</i>
PILOT_PRIMARY_NUMBER	0-64	string	The pilot subscriber's primary number (HPBX subscribers). <i>PLEASE NOTE: This is not included in default set of EDR fields from Sipwise C5 version mr5.0 upwards.</i>
PRIMARY_NUMBER	0-64	string	The VoIP number of the subscriber with the highest ID (DID or primary number).

Table 19: (continued)

Body Element	Length	Type	Description
OLD_PROFILE_NAME	0-255	string	The old status of the event. Depending on the event_type: start_profile: Empty. end_profile: The name of the subscriber profile which got removed from the subscriber. update_profile: The name of the former subscriber profile which got updated. start_huntgroup: Empty. end_huntgroup: Empty. start_ivr: Empty. end_ivr: Empty.
NEW_PROFILE_NAME	0-255	string	The new status of the event. Depending on the event_type: start_profile: The name of the subscriber profile which got assigned to the subscriber. end_profile: Empty. update_profile: The name of the new subscriber profile which got applied. start_huntgroup: Empty. end_huntgroup: Empty. start_ivr: Empty. end_ivr: Empty.
TIMESTAMP	23	timestamp	Timestamp of event. Includes date, time with milliseconds (3 decimals).
RESELLER_ID	1-11	uint	Internal ID of the reseller which the event belongs to. <i>PLEASE NOTE: Only available in system exports, not for resellers.</i>
<line_terminator>	1	string	A fixed character. Always \n (special char LF - ASCII 0x0A).

A valid example of one body line of an EDR is (line breaks added for clarity):

```
"1", "start_profile", "sipwise_ext_customer_id_4", "Sipwise GmbH",
"sipwise_ext_subscriber_id_44", "436667778", "", "1", "2014-06-19 11:34:31", "1"
```

The format of the **EDR export files generated for resellers** (as opposed to the complete system-wide export) is identical except for a few missing fields.

Note

Please check the description of fields in the table above, in order to see which fields are omitted for *reseller* related EDR exports.

The list of fields for *reseller* EDR export is defined in `/etc/ngcp-config/config.yml` file, `eventexport.reseller_export` parameter.

8.7.3.6 Extra fields that can be exported to EDRs

There are fields in EDR database that contain **supplementary data** related to subscribers, for example subscriber phone numbers are such data.

Table 20: Supplementary data in EDR fields

Body Element	Length	Type	Description
SUBSCRIBER_PROFILE_SET_NAME	0-255	string	The subscriber's profile set name.
PILOT_SUBSCRIBER_PROFILE_SET_NAME	0-255	string	The profile set name of the subscriber's pilot subscriber.
PILOT_SUBSCRIBER_PROFILE_NAME	0-255	string	The profile name of the subscriber's pilot subscriber.
FIRST_NON_PRIMARY_ALIAS_USERNAME_BEFORE	0-255	string	The subscriber's non-primary alias with lowest ID, before number updates during the operation.
FIRST_NON_PRIMARY_ALIAS_USERNAME_AFTER	0-255	string	The subscriber's non-primary alias with lowest ID, after number updates during the operation.
PILOT_FIRST_NON_PRIMARY_ALIAS_USERNAME_BEFORE	0-255	string	The non-primary alias with lowest ID of the subscriber's pilot subscriber, before number updates during the operation.
PILOT_FIRST_NON_PRIMARY_ALIAS_USERNAME_AFTER	0-255	string	The non-primary alias with lowest ID of the subscriber's pilot subscriber, after number updates during the operation.
NON_PRIMARY_ALIAS_USERNAME	0-255	string	The non-primary alias of a subscriber affected by an <code>update_profile</code> , <code>start_profile</code> or <code>end_profile</code> event to track number changes.
PRIMARY_ALIAS_USERNAME_BEFORE	0-255	string	The subscriber's primary alias, before number updates during the operation.
PRIMARY_ALIAS_USERNAME_AFTER	0-255	string	The subscriber's primary alias, after number updates during the operation.
PILOT_PRIMARY_ALIAS_USERNAME_BEFORE	0-255	string	The primary alias of the subscriber's pilot subscriber, before number updates during the operation.
PILOT_PRIMARY_ALIAS_USERNAME_AFTER	0-255	string	The primary alias of the subscriber's pilot subscriber, after number updates during the operation.
FIRST_NON_PRIMARY_ALIAS_USERNAME_BEFORE_AFTER	0-255	string	Equals <code>FIRST_NON_PRIMARY_ALIAS_USERNAME_BEFORE</code> , if the value is not NULL, otherwise it's the same as <code>FIRST_NON_PRIMARY_ALIAS_USERNAME_AFTER</code> .

Table 20: (continued)

Body Element	Length	Type	Description
PILOT_FIRST_NON_PRIMARY_ALIAS_USERNAME_BEFORE	0-255	string	Equals PILOT_FIRST_NON_PRIMARY_ALIAS_USERNAME_BEFORE if the value is not NULL, otherwise it's the same as PILOT_FIRST_NON_PRIMARY_ALIAS_USERNAME_AFTER.

8.7.3.7 File Trailer Format

The billing file trailer is one single line, which is constructed by the following fields:

```
<md5 sum>
```

The `<md5 sum>` is a 32 character hexadecimal MD5 hash of the *Header* and *Body*.

To validate the billing file, one must remove the Trailer before computing the MD5 sum of the file. The `ngcp-cdr-md5` program included in the `ngcp-cdr-exporter` package can be used to validate the integrity of the file.

Given a CDR-file named as `sipwise_001_20071110123000_0000000004.cdr`, the output of the integrity check for an intact CDR file would be:

```
$ ngcp-cdr-md5 sipwise_001_20071110123000_0000000004.cdr
/tmp/ngcp-cdr-md5.sipwise_001_20071110123000_0000000004.cdr.oqkd4P2zXI: OK
```

If the file has been altered during transmission, the output of the integrity check would be:

```
$ ngcp-cdr-md5 sipwise_001_20071110123000_0000000004.cdr
/tmp/ngcp-cdr-md5.sipwise_001_20071110123000_0000000004.cdr.hUtuhtKEN1: FAILED
md5sum: WARNING: 1 of 1 computed checksum did NOT match
```

8.7.4 File Transfer

Billing files are created twice per hour at minutes 25 and 55 and are stored in the home directory of the `cdrexport` user. If the amount of records within the transmission interval exceeds the threshold of 5000 records per file, multiple billing files are created. If no billing records are found for an interval, a billing file without body data is constructed for easy detection of lost billing files on the 3rd party side.

CDR and EDR files are fetched by a 3rd party billing system using SFTP or SCP with either public key or password authentication using the username `cdrexport`.

If public key authentication is chosen, the public key file has to be stored in the file `.ssh/authorized_keys` below the home directory of the `cdrexport` user (i.e. `/home/jail/home/cdreexport/.ssh/authorized_keys`). Otherwise, a password has to be set for the user.

The 3rd party billing system is responsible for deleting CDR files after fetching them.

Note

The `cdrexport` user is kept in a jailed environment on the system, so it has only access to a very limited set of commandline utilities.

9 Corosync/Pacemaker

9.1 Overview

The Corosync/Pacemaker pair is the successor of the long obsolete and unsupported Heartbeat v2 software package. While Heartbeat v2 was playing the role of both the **Group Communication System** (GCS) and the **Cluster Resource Manager** (CRM), these roles are split under the new system. Corosync is the GCS and in charge of communication, while Pacemaker sits on top of the GCS and plays the role of the CRM, managing the resources and responding to changes in the cluster status.

9.2 Migration

Before the migration install the latest hotfixes for the packages: `ngcp-system-tools-pro`, `ngcp-ngcpcfg`, `ngcp-ngcpcfg-ha`.

An existing cluster under Heartbeat v2 can be migrated to Corosync/Pacemaker using the script `ngcp-migrate-ha-crm`. This script automates the following steps:

1. Locally download the Heartbeat v2 Debian package to allow rollback
2. Download and prefetch the Debian packages for Corosync, Pacemaker, and its dependencies
3. Remove `/etc/ha.d/haresources` to disable stopping of resources by Heartbeat v2
4. Stop Heartbeat v2 and remove its Debian package including all configuration
5. Install Corosync, Pacemaker, and all dependencies
6. Switch `config.yml` variables `ha.gcs` and `ha.crm` to `corosync` and `pacemaker` respectively
7. Rebuild all config from templates
8. Start the new GCS and CRM services

The script must be run on the standby node, and the steps described above are first performed locally (on the standby node), followed by the node's peer (the active node). This is to minimise resource downtime.



Caution

Switching the values of `ha.gcs` or `ha.crm` is not enough to actually effect any change. These values are merely reflective of which software is installed and must not be modified without also altering the underlying software.

The migration needs to be run on non-migrated pairs of nodes, from the standby node of each pair, and the services need to be all in a good state (from `ngcp-service summary` point of view). The program will perform these sanity checks before making it possible to proceed. The user will also be prompted for confirmation, which can be skipped for non-interactive use with the `FORCE` environment variable.

For a Carrier system the configuration settings will be set per pair, so that it does not affect the entire cluster. Once the whole cluster has been migrated these configuration files should be merged into the global one. If the switch does not need to be staged, then the

`ngcp-parallel-ssh(8)` command can help with that, with its inactive host selector, such as `ngcp-parallel-ssh inactive "FORCE=yes ngcp-migrate-ha-crm"`.

9.2.1 Rollback

Rollback can be done by using `ngcp-migrate-ha-crm --rollback`, which involves reversing the steps outlined above: Removal of `corosync` and `pacemaker`, installation of the downloaded `heartbeat-2` Debian package, and reverting `ha.gcs` and `ha.crm` to their previous values `heartbeat-2`.

9.3 Corosync

Corosync is the **Group Communication System** (GCS). Its configuration resides in `/etc/corosync/corosync.conf` and describes the following details:

- Shared cluster name of `sp`
- Quorum config as a two-node cluster (see below)
- Config details for both nodes:
 - Name (`sp1` and `sp2`, or `a` and `b` node names)
 - Node ID (1 and 2 respectively)
 - Local IP address for communication

9.3.1 Quorum

Corosync uses a voting system to determine the state of the cluster. Each configured node in the cluster receives one vote. A quorum is defined as a majority presence within the cluster, meaning at least 50% of the configured nodes plus one, or $q = n / 2 + 1$. For example, if 8 nodes were configured, a quorum would be present if at least 5 nodes are communicating with each other. In this state, the cluster is said to be quorate, which means it can operate normally. (Any remaining nodes, 3 in the worst case, would see the cluster as inquorate and would relinquish all their resources.)

A two-node cluster is a special case as under the formula above, a quorum would consist of 2 functioning nodes. The Corosync config setting `two_node: 1` overrides this and artificially sets the quorum to 1. This means that under a split-brain scenario (each node seeing only 1 vote), both nodes would see the cluster as quorate and try to become active, instead of both nodes going standby.

In addition to this, Pacemaker itself also uses an internal scoring system for individual resources. This mechanism is described below and not directly related to the quorum.

9.4 Pacemaker

Pacemaker uses the communication service provided by Corosync to manage local resources. All status and configuration information is shared between all Pacemaker instances within the cluster as long as communication is up. This means that any

configuration change done on any node will immediately and automatically be propagated to all other nodes in the cluster.

Pacemaker internally uses an XML document to store its configuration, called "CIB" stored in `/var/lib/pacemaker/cib/cib.xml`. However, this XML document **must never** be edited or modified directly. Instead, a shell-like interface `crm` is provided to talk to Pacemaker, query status information, alter cluster state, view and modify configuration, etc. Any configuration change done through `crm` is immediately reflected in the CIB XML, locally as well as on all other nodes.

**Warning**

To repeat, do not ever directly modify Pacemaker's XML configuration.

As an added bonus, just to make things more awkward, the syntax used by `crm` is not XML at all, but rather uses a Cisco-like hierarchy.

Commands can be issued to `crm` either directly from the shell as command-line arguments, or interactively by entering a Cisco-like shell. So for example, the current config can be viewed either from the shell with:

```
root@spl:~# crm config show
...
```

Or interactively, as either:

```
root@spl:~# crm
crm(live/spl)# config
crm(live/spl)configure# show
...
```

or

```
root@spl:~# crm
crm(live/spl)# config show
...
```

Interactive online help is provided by the `ls` command to list commands valid in the current context, or using the `help` command for a more verbose help output.

9.5 Query Status

The current cluster status can be viewed with the top-level `status` command:

```
crm(live/sp1)# status
Stack: corosync
Current DC: sp2 (version unknown) - partition with quorum
Last updated: Fri Nov 22 18:38:06 2019
Last change: Fri Nov 22 18:25:28 2019 by hacluster via crmd on sp1
```

```
2 nodes configured
7 resources configured
```

```
Online: [ sp1 sp2 ]
```

```
Full list of resources:
```

```
Resource Group: g_vips
  p_vip_eth1_v4_1 (ocf::heartbeat:IPaddr):      Started sp1
  p_vip_eth2_v4_1 (ocf::heartbeat:IPaddr):      Started sp1
Resource Group: g_ngcp
  p_monit_services (ocf::ngcp:monit-services):  Started sp1
Clone Set: c_ping [p_ping]
  Started: [ sp1 sp2 ]
Clone Set: fencing [st-null]
  Started: [ sp1 sp2 ]
```

If the status is queried from `sp2` instead, the output will be the same. Most importantly, the resources will **not** show up as "stopped" on `sp2` but instead will be reported as running on `sp1`.

The resources reported are described in the configuration section below.

9.6 Config Management

The NGCP templates do not operate on Pacemaker's CIB XML directly, but instead produce a file in CRM syntax in `/etc/pacemaker/`. This file is not handled by Pacemaker directly, but instead is loaded into Pacemaker via the `crm` command `config load replace`. It shouldn't be necessary to do this manually, as the script `ngcp-ha-crm-reload` handles this automatically, which is called from the config file's postbuild script.

Changes to the config don't need to be saved explicitly. This is done automatically by Pacemaker, as well as sharing any changes with all other members of the cluster.

In `crm`, changes made to the config are cached until made active with `commit`, or discarded with `refresh`. Changes to resource status can be avoided by enabling maintenance mode (see below).



Important

However, since our config is loaded from a template, any changes done to the config through `crm` manually are transient and will be lost the next time a config reload happens.

The currently active config can be shown with `config show` and should be logically identical to the contents of `/etc/pacemaker/c`

```
crm(live/sp1)# config show
node 1: sp1
node 2: sp2
primitive p_monit_services ocf:ngcp:monit-services \
    meta migration-threshold=20 \
    meta failure-timeout=800 \
    op monitor interval=20 timeout=60 on-fail=restart \
    op_params on-fail=restart
primitive p_ping ocf:pacemaker:ping \
    params host_list="10.15.20.30 192.168.211.1" multiplier=1000 dampen=5s \
    meta failure-timeout=800 \
    op monitor interval=1 timeout=60 on-fail=restart \
    op_params timeout=60 on-fail=restart
primitive p_vip_eth1_v4_1 IPaddr \
    params ip=192.168.255.250 nic=eth1 cidr_netmask=24 \
    op monitor interval=5 timeout=60 on-fail=restart \
    op_params on-fail=restart
primitive p_vip_eth2_v4_1 IPaddr \
    params ip=192.168.1.161 nic=eth2 cidr_netmask=24 \
    op monitor interval=5 timeout=60 on-fail=restart \
    op_params on-fail=restart
primitive st-null stonith:null \
    params hostlist="sp1 sp2"
group g_ngcp p_monit_services
group g_vips p_vip_eth1_v4_1 p_vip_eth2_v4_1
clone c_ping p_ping
clone fencing st-null
location l_ngcp g_ngcp \
    rule pingd: defined pingd
colocation l_ngcp_with_vip inf: g_ngcp g_vips
location l_vips g_vips \
    rule pingd: defined pingd
order o_vip_then_ngcp Mandatory: g_vips g_ngcp
```

```
property cib-bootstrap-options: \  
    have-watchdog=false \  
    cluster-infrastructure=corosync \  
    cluster-name=sp \  
    stonith-enabled=yes \  
    no-quorum-policy=ignore \  
    startup-fencing=yes \  
    maintenance-mode=false \  
    last-lrm-refresh=1574443528  
rsc_defaults rsc-options: \  
    resource-stickiness=100
```

9.6.1 General Concepts

- The configuration consists of a collection of objects of various types with various attributes.
- Each object has a unique identifying name that can be used to refer to it.
- Usually the type of the object is the first word and the identifying name is the second. For example, `clone c_ping p_ping` defines a `clone` type object with the name `c_ping`.
- The unique name is used e.g. when deleting an object (`config del ...`), when starting or stopping a resource, when referring to resources from a group, etc.

9.6.2 Resources

Resources are the primary type of objects that Pacemaker handles. A resource is anything that can be started or stopped, and a resource is normally allowed to run on one node only. A resource is defined as a `primitive` type object.

Pacemaker supports many types of resources, all of which have different options that can be given to them. The config syntax defines that options given to a resource itself are prefixed with `params`, while options that influence how a resource should be managed are prefixed with `meta`. Options that are relevant to operations that can be performed on a resource are prefixed with `op`.

Resources are grouped into classes, providers, and types. Details about them (e.g. which options they support) can be obtained through the `ra` menu.

```
crm(live/sp1)ra# info IPaddr  
Manages virtual IPv4 addresses (portable version) (ocf:heartbeat:IPaddr)  
...
```

9.6.2.1 Shared IP Addresses

```
primitive p_vip_eth1_v4_1 IPAddr \
    params ip=192.168.255.250 nic=eth1 cidr_netmask=24 \
    op monitor interval=5 timeout=60 on-fail=restart \
    op_params on-fail=restart
```

This defines a resource of type `IPAddr` with name `p_vip_eth1_v4_1` and the given parameters (address, netmask, interface). Pacemaker will check for the existence of the address every 5 seconds, with an action timeout of 60 seconds. If the monitor action fails, the resource is restarted.

9.6.2.2 System Services

```
primitive p_monit_services ocf:ngcp:monit-services \
    meta migration-threshold=20 \
    meta failure-timeout=800 \
    op monitor interval=20 timeout=60 on-fail=restart \
    op_params on-fail=restart
```

While Pacemaker has support for native `systemd` services, for the time being we're still relying on `monit` to manage our services. Therefore, services are defined in Pacemaker virtually identical to how they were defined in Heartbeat v2, through a `monit-services start/stop script`. The old Heartbeat script was `/etc/ha.d/resource.d/monit-services` and the new script used by Pacemaker is `/etc/ngcp-ocf/monit-services`.

Note

The primary difference between the two scripts is the support for a `monitor` action for Pacemaker, which can be configured via the `config.yml` variable `ha.monitor_services`. It can be set to *full* to periodically use the output of `ngcp-service summary` to determine whether all services are running or not. The default value is *none*, which preserves backwards compatibility with the behavior of Heartbeat v2, by performing no periodic checks of the status of the services.

- `meta migration-threshold=20` means that the resource will be migrated away (instead of restarted) after 20 failures. See the discussion on failure counts below.
- `meta failure-timeout=800` means that the failure count should be reset to zero if the last failure occurred more than 800 seconds ago. (However, the actual timer depends on the `cluster-recheck-interval`.)
- Run the monitor action every 20 seconds with a timeout of 60 seconds and restart the resource on failure.

9.6.2.3 Ping Nodes

```
primitive p_ping ocf:pacemaker:ping \
    params host_list="10.15.20.30 192.168.211.1" multiplier=1000 dampen=5s \
    meta failure-timeout=800 \
    op monitor interval=1 timeout=60 on-fail=restart \
```

```
op_params timeout=60 on-fail=restart
```

The builtin `pingd` service, using a resource name that intelligently is not named `pingd` but rather just `ping`, replaces Heartbeat's ping nodes. It supports multiple ping backends, and uses `fping` by default.

Each configured ping node (each entry in `host_list`) produces a score of 1 if that ping node is up. The scores are summed up and multiplied by the `multiplier`. So in the example above, a score of 2000 is generated if both ping nodes are up. Pacemaker will then prefer the node which produces the higher score.

- `dampen=5s` means to wait 5 seconds after a change occurred to prevent transient glitches from causing service flapping.
- Other options are the same as described above.

9.6.2.4 Fencing/STONITH

```
primitive st-null stonith:null \
    params hostlist="sp1 sp2"
```

Pacemaker will generate a warning if no fencing mechanism is configured, therefore we configure the `null` fencing mechanism.

Pacemaker supports several proper fencing mechanism and these might eventually get supported in the future.

9.6.2.5 Groups

```
group g_ngcp p_monit_services
group g_vips p_vip_eth1_v4_1 p_vip_eth2_v4_1
```

To manage, control, and restrict multiple resources at the same time, resources can be grouped into single objects. The group `g_ngcp` is pointless for the time being (it contains only a single other resource) but will become useful once native `systemd` resources are in use. The group `g_vips` ensures that all shared IP addresses are active at the same time.

9.6.2.6 Clones

```
clone c_ping p_ping
clone fencing st-null
```

Since a single resource normally only runs on one node, a clone can be defined to allow a resource to run on all nodes. We want the `pingd` service and the fencing service to always run on all nodes.

9.6.2.7 Constraints

```
colocation l_ngcp_with_vip inf: g_ngcp g_vips
```

This tells Pacemaker that we want to force the `g_ngcp` resource on the same node that is running the `g_vips` resource.

```
location l_ngcp g_ngcp \  
    rule pingd: defined pingd  
location l_vips g_vips \  
    rule pingd: defined pingd
```

This tells Pacemaker that these resources depend on the `pingd` service being healthy. If `pingd` fails on one node (ping nodes are unavailable), then Pacemaker will shut down the constrained resources.

```
order o_vip_then_ngcp Mandatory: g_vips g_ngcp
```

This tells Pacemaker that the shared IP addresses must be up and running before the system services can be started.

9.6.3 Cluster Options

```
property cib-bootstrap-options: \  
    have-watchdog=false \  
    cluster-infrastructure=corosync \  
    cluster-name=sp \  
    stonith-enabled=yes \  
    no-quorum-policy=ignore \  
    startup-fencing=yes \  
    maintenance-mode=false \  
    last-lrm-refresh=1574443528
```

Relevant options are:

- `have-watchdog=false` indicates that no external watchdog service such as SBD is in use.
- `cluster-name=sp` is to match the configuration of Corosync.
- `stonith-enabled=yes` is required to suppress a warning message, even though no real STONITH (null fencing mechanism) is in use.
- `no-quorum-policy=ignore` tells Pacemaker to continue normally if quorum is lost. This is the only setting that makes sense in a two-node cluster.
- `startup-fencing=yes` is also needed to suppress a warning even though no real fencing is in use. This tells Pacemaker to shoot nodes that are not present immediately after startup.
- `maintenance-mode=false` tells Pacemaker to actually perform resource actions. If maintenance mode is enabled, Pacemaker will continue to run, but will not start or stop any services. This should be enabled before loading a new config, and then disabled afterwards. The script `ngcp-ha-crm-reload` does this.

9.6.4 Failure Counts

Pacemaker keeps a failure count for each resource, which is somewhat hidden from view, but can largely influence its behaviour. Each time a service fails (either during runtime or during startup), the failure count is increased by one. If the failure count exceeds the configured `migration-threshold`, Pacemaker will cease trying to start the service and will migrate the service away to another node. In `crm status` this simply shows up as `stopped`.

Failure counts can be cleared automatically if the `failure-timeout` setting is configured for a resource. This timeout is counted after the last time the resource has failed, and is checked periodically according to the `cluster-recheck-interval`. In other words, a very short failure timeout won't have any effect unless the recheck interval is also very short.



Important

If no failure timeout is configured, any existing failure count must be cleared manually.

9.6.4.1 Checking Failure Counts

The failure count for a resource can be checked from the shell via `crm_failcount`, for example:

```
root@sp1:~# crm_failcount -G -r p_monit_services
scope=status name=fail-count-p_monit_services value=0
```

The failure count on a different node can also be examined:

```
root@sp1:~# crm_failcount -G -r g_ngcp -N sp2
scope=status name=fail-count-g_ngcp value=0
```

The same can be done via `crm`:

```
crm(live/sp1)resource# failcount g_vips show sp1
scope=status name=fail-count-g_vips value=0
crm(live/sp1)resource# failcount c_ping show sp2
scope=status name=fail-count-c_ping value=0
```

As a shortcut, the script `ngcp-ha-show-failcounts` is provided:

```
root@sp1:~# ngcp-ha-show-failcounts
p_vip_eth1_v4_1:
  sp1: 0
```

```
sp2: 0
p_vip_eth2_v4_1:
sp1: 0
sp2: 0
p_monit_services:
sp1: 0
sp2: 0
```

9.6.4.2 Clearing Failure Counts

Analogous to checking a failure count, it can be cleared using any one of these methods:

```
root@sp1:~# crm_failcount -D -r p_monit_services
Cleaned up p_monit_services on sp1
root@sp1:~# crm resource failcount g_ngcp delete sp2
Cleaned up p_monit_services on sp2
root@sp1:~# crm
crm(live/sp1)# resource
crm(live/sp1)resource# failcount c_ping delete sp1
Cleaned up p_ping:0 on sp1
Cleaned up p_ping:1 on sp1
crm(live/sp1)resource# bye
root@sp1:~# ngcp-ha-clear-failcounts
Cleaned up p_monit_services on sp2
Cleaned up p_monit_services on sp1
```

In addition, the `crm` command `resource cleanup` also resets failure counts.

9.6.5 Resource Scores

Pacemaker uses an internal scoring system to determine which resources to run where. A resource will be run on the node on which it received the highest score. If a resource has a negative score, that resource will not be run at all. If a resource has the same score on multiple nodes, then the resource will be run on any one of those nodes. Scores can be calculated and acted upon through various config settings.

A score value of `infinity` (and negative infinity) to force certain states is provided, which evaluates to not infinity at all, but rather to a static value of one million. This can be used to artificially manipulate resource scores to force running a resource on a particular node, or forbid a resource from running on particular nodes.

Scores can be inspected through the `crm` command `resource scores`.

9.7 Common Tasks

9.7.1 Takeover and Standby

The commands `ngcp-make-active` and `ngcp-make-standby` work normally. Under Pacemaker, they function through the `crm` command `resource move` to create a temporary location constraint on `g_vips`. This can be done manually through:

```
crm resource move g_vips sp1 30
```

The lifetime of 30 seconds is needed because `g_ngcp` depends on the location of `g_vips`, and therefore `g_ngcp` needs to be stopped before `g_vips` can be stopped. The location constraint must remain active until `g_ngcp` has been completely and successfully stopped.

Note

These commands only effect the status of the running resources, and not the status of the node itself. This means that after going standby, Pacemaker will immediately be ready to take over the resources again if needed. See below for a discussion on node status.

Similarly, `ngcp-check-active` uses the output of `crm resource status g_vips` to determine whether the local node is active or not.

9.7.2 Node Status (Online/Standby)

In addition to the status and location of individual resources, nodes themselves can also go into standby mode. The submenu `node` in `crm` has the relevant options.

A node in standby mode will not only give up all of its resources, but will also refuse to take them over until it's back online. Therefore, it's possible to set both nodes to standby mode and shut down all resources on both nodes.

Note

A node in standby mode will still participate in GCS communications and remain visible to the rest of the cluster.

Use `crm node standby` to set the local node to standby mode. A remote node can be set to standby using e.g. `crm node standby sp2`.

By default, the standby mode remains active until it's cancelled manually (a lifetime of `forever`). Alternatively, a lifetime of `reboot` can be specified to tell Pacemaker that after the next reboot, the node should automatically come back online. Example:
`crm node standby sp2 reboot`

To cancel standby mode, use `crm node online`, optionally followed by the node name.

To show the current status of all nodes, use `crm node show`. The top-level `crm status` also shows this.

9.7.3 Maintenance Mode

If Pacemaker's maintenance mode is enabled, it will continue to operate normally, i.e. continue to run and monitor resources, but will refuse to stop or start any resources. This is useful to make changes to the running config, and is done automatically by `ngcp-ha-crm-reload`.

To enable and disable maintenance mode:

```
crm maintenance on
crm maintenance off
```

or using the more lower level method:

```
crm configure property maintenance-mode=true
crm configure property maintenance-mode=false
```

9.7.4 CLI Alternatives

Several of the commands available through `crm` are also available through standalone CLI tools, such as `crm_failcount`, `crm_standby`, `crm_resource`, etc. They generally have less friendly syntax and so researching them is left as an exercise to the reader.

10 Provisioning REST API Interface

The Sipwise C5 provides the REST API interface for interconnection with 3rd party tools.

The Sipwise C5 provides a REST API to provision various functionality of the platform. The entry point - and at the same time the official documentation - is at <https://<your-ip>:1443/api>. It allows both administrators and resellers (in a limited scope) to manage the system.

You can either authenticate via username and password of your administrative account you're using to access the admin panel, or via SSL client certificates. Find out more about client certificate authentication in the online API documentation.

10.1 API Workflows for Customer and Subscriber Management

The typical tasks done on the API involve managing customers and subscribers. The following chapter focuses on creating, changing and deleting these resources.

The standard life cycle of a customer and subscriber is:

1. Create customer contact
2. Create customer
3. Create subscribers within customer
4. Modify subscribers
5. Modify subscriber preferences (features)
6. Terminate subscriber
7. Terminate customer

The boiler-plate to access the REST API is described in the online API documentation at [/api/#auth](#). A simple example in Perl using password authentication looks as follows:

```
#!/usr/bin/perl -w
use strict;
use v5.10;

use LWP::UserAgent;
use JSON qw();

my $uri = 'https://ngcp.example.com:1443';
my $ua = LWP::UserAgent->new;
my $user = 'myusername';
my $pass = 'mypassword';
$ua->credentials('ngcp.example.com:1443', 'api_admin_http', $user, $pass);
my ($req, $res);
```

For each customer you create, you need to assign a billing profile id. You either have the ID stored somewhere else, or you need to fetch it by searching for the billing profile handle.

```
my $billing_profile_handle = 'my_test_profile';
$req = HTTP::Request->new('GET', "$uri/api/billingprofiles/?handle=$billing_profile_handle" <->
);
$res = $ua->request($req);
if($res->code != 200) {
    die "Failed to fetch billing profile: ".$res->decoded_content."\n";
}
my $billing_profile = JSON::from_json($res->decoded_content);
my $billing_profile_id = $billing_profile->{_embedded}->{'ngcp:billingprofiles'}->{id};
say "Fetched billing profile, id is $billing_profile_id";
```

A customer is mainly a billing container for subscribers without a real identification other than the *external_id* property you might have stored somewhere else (e.g. the ID of the customer in your CRM). To still easily identify a customer, a customer contact is required. It is created using the */api/customercontacts/* resource.

```
$req = HTTP::Request->new('POST', "$uri/api/customercontacts/");
$req->header('Content-Type' => 'application/json');
$req->content(JSON::to_json({
    firstname => 'John',
    lastname => 'Doe',
    email => 'john.doe@example.com'
}));
$res = $ua->request($req);
if($res->code != 201) {
    die "Failed to create customer contact: ".$res->decoded_content."\n";
}
my $contact_id = $res->header('Location');
$contact_id =~ s/^.+\/(\d+)\$\/$1/; # extract the ID from the Location header
say "Created customer contact, id is $contact_id";
```



Important

To get the ID of the recently created resource, you need to parse the *Location* header. In future, this approach will be changed for POST requests. The response will also optionally return the ID of the resource. It will be controlled via the *Prefer: return=representation* header as it is already the case for PUT and PATCH.



Warning

The example above implies the fact that you access the API via a reseller user. If you are accessing the API as the admin user, you also have to provide a *reseller_id* parameter defining the reseller this contact belongs to.

Once you have created the customer contact, you can create the actual customer.

```
$req = HTTP::Request->new('POST', "$uri/api/customers/");
$req->header('Content-Type' => 'application/json');
$req->content(JSON::to_json({
    status => 'active',
    contact_id => $contact_id,
    billing_profile_id => $billing_profile_id,
    type => 'sipaccount',
    external_id => undef, # can be set to your crm's customer id
}));
$res = $ua->request($req);
if($res->code != 201) {
    die "Failed to create customer: ".$res->decoded_content."\n";
}
my $customer_id = $res->header('Location');
$customer_id =~ s/^.+\/(\d+)$\/$1/; # extract the ID from the Location header
say "Created customer, id is $customer_id";
```

Once you have created the customer, you can add subscribers to it. One customer can hold multiple subscribers, up to the *max_subscribers* property which can be set via */api/customers/*. If this property is not defined, a virtually unlimited number of subscribers can be added.

```
$req = HTTP::Request->new('POST', "$uri/api/subscribers/");
$req->header('Content-Type' => 'application/json');
$req->content(JSON::to_json({
    status => 'active',
    customer_id => $customer_id,
    primary_number => { cc => 43, ac => 9876, sn => 10001 }, # the main number
    alias_numbers => [ # as many alias numbers the subscriber can be reached at (or skip ←
        param if none)
        { cc => 43, ac => 9877, sn => 10001 },
        { cc => 43, ac => 9878, sn => 10001 }
    ],
    username => 'test_10001'
    domain => 'ngcp.example.com',
    password => 'secret subscriber pass',
    webusername => 'test_10001',
    webpassword => undef, # set undef if subscriber shouldn't be able to log into sipwise ←
        csc
    external_id => undef, # can be set to the operator crm's subscriber id
}));
$res = $ua->request($req);
if($res->code != 201) {
    die "Failed to create subscriber: ".$res->decoded_content."\n";
}
```

```

}
my $subscriber_id = $res->header('Location');
$subscriber_id =~ s/^.+\/(\d+)\$/\1/; # extract the ID from the Location header
say "Created subscriber, id is $subscriber_id";

```



Important

A domain must exist before creating a subscriber. You can create the domain via `/api/domains/`.

At that stage, the subscriber can connect both via SIP and XMPP, and can be reached via the primary number, all alias numbers, as well as via the SIP URI.

If you want to set call forwards for the subscribers, then perform an API call as follows.

```

$req = HTTP::Request->new('PUT', "$uri/api/callforwards/$subscriber_id");
$req->header('Content-Type' => 'application/json');
$req->header('Prefer' => "return=minimal"); # use return=representation to get full json ←
      response
$req->content(JSON::to_json({
  cfna => { # set a call-forward if subscriber is not registered
    destinations => [
      { destination => "4366610001", timeout => 10 }, # ring this for 10s
      { destination => "4366710001", timeout => 300 }, # if no answer, ring that for ←
        300s
    ],
    times => undef # no time-based call-forward, trigger cfna always
  }
}));
$res = $ua->request($req);
if($res->code != 204) { # if return=representation, it's 200
  die "Failed to set cfna for subscriber: ".$res->decoded_content."\n";
}

```

You can set cfu, cfna, cfb, cft, cfs, cfr and cfo via this API call, also all at once. Destinations can be hunting lists as described above or just a single number. Also, a time set can be provided to trigger call forwards only during specific time periods.

To provision certain features of a subscriber, you can manipulate the subscriber preferences. You can find a full list of preferences available for a subscriber at `/api/subscriberpreferencedefs/`.

```

$req = HTTP::Request->new('GET', "$uri/api/subscriberpreferences/$subscriber_id");
$res = $ua->request($req);
if($res->code != 200) {
  die "Failed to fetch subscriber preferences: ".$res->decoded_content."\n";
}

```

```

}
my $prefs = JSON::from_json($res->decoded_content);
delete $prefs->{_links}; # not needed in update

$prefs->{prepaid_library} = 'libinewrate'; # switch to inew billing
$prefs->{block_in_clir} = JSON::true; # reject incoming anonymous calls
$prefs->{block_in_list} = [ # reject calls from the following numbers:
    '4366412345', # this particular number
    '431*', # all vienna/austria numbers
];
$req = HTTP::Request->new('PUT', "$uri/api/subscriberpreferences/$subscriber_id");
$req->header('Content-Type' => 'application/json');
$req->header('Prefer' => "return=minimal"); # use return=representation to get full json ←
    response
$req->content(JSON::to_json($prefs));
$res = $ua->request($req);
if($res->code != 204) {
    die "Failed to update subscriber preferences: ".$res->decoded_content."\n";
}
say "Updated subscriber preferences";

```

Modifying numbers assigned to a subscriber, changing the password, locking a subscriber, etc. can be done directly on the subscriber resource.

```

$req = HTTP::Request->new('GET', "$uri/api/subscribers/$subscriber_id");
$res = $ua->request($req);
if($res->code != 200) {
    die "Failed to fetch subscriber: ".$res->decoded_content."\n";
}
my $sub = JSON::from_json($res->decoded_content);
delete $sub->{_links}; # not needed in update
push @{$sub->{alias_numbers}}, { cc => 1, ac => 5432, sn => $t }; # add this number
push @{$sub->{alias_numbers}}, { cc => 1, ac => 5433, sn => $t }; # add another number

$req = HTTP::Request->new('PUT', "$uri/api/subscribers/$subscriber_id");
$req->header('Content-Type' => 'application/json');
$req->header('Prefer' => "return=minimal"); # use return=representation to get full json ←
    response
$req->content(JSON::to_json($sub));
$res = $ua->request($req);
if($res->code != 204) {
    die "Failed to update subscriber: ".$res->decoded_content."\n";
}
say "Updated subscriber";

```

At the end of a subscriber life cycle, it can be terminated. Once terminated, you can NOT recover the subscriber anymore.

```

$req = HTTP::Request->new('DELETE', "$uri/api/subscribers/$subscriber_id");
$res = $ua->request($req);
if($res->code != 204) {
    die "Failed to terminate subscriber: ".$res->decoded_content."\n";
}
say "Terminated subscriber";

```

Note that certain information is still available in the internal database to perform billing/rating of calls done by this subscriber. Nevertheless, the data is removed from the operational tables of the database, so the subscriber is not able to connect to the system, login or make calls/chats.

Resources modification can be done via the GET/PUT combination. Alternatively, you can add, modify or delete single properties of a resource without actually fetching the whole resource. See an example below where we terminate the status of a customer using the PATCH method.

```

$req = HTTP::Request->new('PATCH', "$uri/api/customers/$customer_id");
$req->header('Content-Type' => 'application/json-patch+json');
$req->header('Prefer' => "return=minimal"); # use return=representation to get full json ↔ response
$req->content(JSON::to_json([
    { op => 'replace', path => '/status', value => 'terminated' }
]));
$res = $ua->request($req); # this will also terminate all still active subscribers
if($res->code != 204) {
    die "Failed to terminate customer: ".$res->decoded_content."\n";
}
say "Terminated customer";

```

10.2 API performance considerations

The REST API is designed with pagination support built-in. It is mandatory, to implement pagination in your API clients. If you circumvent pagination by setting the number of rows requested in one API call to a very high number the following side effects may appear:

1. An HTTP timeout at the gateway may occur. The default timeout limit is set to 60s. You can change it by creating a patchtt file for the following template: */etc/ngcp-config/templates/etc/nginx/sites-available/ngcp-panel_admin_api.tt2*.
2. Other parts of the system might become unresponsive due to mysql table locks. This especially applies to endpoints related to the Customers entity.

11 Configuration Framework

The Sipwise C5 provides a configuration framework for consistent and easy to use low level settings management. A basic usage of the configuration framework only needs two actions already used in previous chapters:

- Edit `/etc/ngcp-config/config.yml` file.
- Execute `ngcpcfg apply 'my commit message'` command.

Low level management of the configuration framework might be required by advanced users though. This chapter explains the architecture and usage of Sipwise C5 configuration framework. If the basic usage explained above fits your needs, feel free to skip this chapter and return to it when your requirements change.

A more detailed workflow of the configuration framework for creating a configuration file consists of 7 steps:

- Generation or editing of configuration templates and/or configuration values.
- Generation of the configuration files based on configuration templates and configuration values defined in `config.yml`, `constants.yml` and `network.yml` files.
- Execution of `prebuild` commands if defined for a particular configuration file or configuration directory.
- Placement of the generated configuration file in the target directory. This step is called `build` in the configuration framework.
- Execution of `postbuild` commands if defined for that configuration file or configuration directory.
- Execution of `services` commands if defined for that configuration file or configuration directory. This step is called `services` in the configuration framework.
- Saving of the generated changes. This step is called `commit` in the configuration framework.

11.1 Configuration templates

The Sipwise C5 provides configuration file templates for most of the services it runs. These templates are stored in the directory `/etc/ngcp-config/templates`.

Example: Template files for `/etc/ngcp-sems/sems.conf` are stored in `/etc/ngcp-config/templates/etc/ngcp-sems/`.

There are different types of files in this template framework, which are described below.

11.1.1 `.tt2`, `.customtt.tt2` and `.patchtt.tt2` files

These files are the main template files that will be used to generate the final configuration file for the running service. They contain all the configuration options needed for a running Sipwise C5 system. The configuration framework will combine these files with the values provided by `config.yml`, `constants.yml` and `network.yml` to generate the appropriate configuration file.

Example: Let's say we are changing the IP used by kamailio load balancer on interface *eth0* to IP 1.2.3.4. This will change kamailio's listen IP address, when the configuration file is generated. A quick look to the template file under */etc/ngcp-config/templates/etc/kamailio/lb/kamailio.cfg* will show a line like this:

```
listen=udp:[% ip %]:[% kamailio.lb.port %]
```

After applying the changes with the *ngcpcfg apply 'my commit message'* command, a new configuration file will be created under */etc/kamailio/lb/kamailio.cfg* with the proper values taken from the main configuration files (in this case *network.yml*):

```
listen=udp:1.2.3.4:5060
```

All the low-level configuration is provided by these *.tt2* template files and the corresponding *config.yml* file. Anyway, advanced users might require a more particular configuration.

Instead of editing *.tt2* files, the configuration framework recognises *.customtt.tt2* files. These files are the same as *.tt2*, but they have higher priority when the configuration framework creates the final configuration files. If you need to introduce changes in a template, you must always copy the required *.tt2* file to *.customtt.tt2*, make changes in the latter file one and leave the *.tt2* file untouched. This way, the system will use the new custom configuration allowing you to switch back to the original one quickly.

Example: We'll create */etc/ngcp-config/templates/etc/lb/kamailio.cfg.customtt.tt2* and use it for our customized configuration. In this example, we'll just append a comment at the end of the template.

```
cd /etc/ngcp-config/templates/etc/kamailio/lb
cp kamailio.cfg.tt2 kamailio.cfg.customtt.tt2
echo '# This is my last line comment' >> kamailio.cfg.customtt.tt2
ngcpcfg apply 'my commit message'
```

The *ngcpcfg* command will generate */etc/kamailio/lb/kamailio.cfg* from our custom template instead of the general one:

```
tail -1 /etc/kamailio/lb/kamailio.cfg
# This is my last line comment
```



Warning

users have to upgrade all *.customtt.tt2* manually every time *.tt2* is upgraded, as *ngcpcfg* completely ignores new code in *.tt2* received from new package version.

The huge drawback of *.customtt.tt2* files are necessity to keep them up-to-date manually. Keeping them outdated will cause the system misbehaviour as different components will use different code version (as new *.tt2* version will be overwritten by old *.customtt.tt2*).

The `.patchtt.tt2` concept should help users here. It will minimise the manual efforts by using linux "patch" utility. The `ngcpcfg` tool is searching for `.patchtt.tt2` files every time `ngcpcfg build` has been called. If `.patchtt.tt2` is detected, the `ngcpcfg` tool will try to apply `.patchtt.tt2` on `.tt2` and store result in `.customtt.tt2` if no conflicts noticed during patching. Further building process happens in a common way. Example:

```
root@spce:~# ngcpcfg build /etc/kamailio/lb/kamailio.cfg
spce: yml configs were validated successfully
spce: configs were checked successfully
spce: Validating patch '/etc/ngcp-config/templates/etc/kamailio/lb/kamailio.cfg.patchtt.tt2'
spce: Applying patch '/etc/ngcp-config/templates/etc/kamailio/lb/kamailio.cfg.patchtt.tt2'
spce: Successfully created '/etc/ngcp-config/templates/etc/kamailio/lb/kamailio.cfg.customtt.tt2'
spce: Requested patchtt operation has finished successfully.
Loading /etc/ngcp-config/config.yml in memory: OK
Loading /etc/ngcp-config/network.yml in memory: OK
Loading /etc/ngcp-config/constants.yml in memory: OK
spce: Generating /etc/kamailio/lb/kamailio.cfg: OK
spce: Executing postbuild for /etc/kamailio/lb/kamailio.cfg
root@spce:~#
```

To convert some/all the current `.customtt.tt2` users can use command `ngcpcfg patch --from-customtt [<customtt_file>]`:

```
root@spce:~# ngcpcfg patch --from-customtt /etc/ngcp-config/templates/etc/kamailio/lb/
kamailio.cfg.customtt.tt2
spce: Validating customtt '/etc/ngcp-config/templates/etc/kamailio/lb/kamailio.cfg.customtt
.tt2'
spce: Creating patchtt file '/etc/ngcp-config/templates/etc/kamailio/lb/kamailio.cfg.
patchtt.tt2'
spce: Requested customtt operation has finished successfully.
root@spce:~#
```

Here is the example of newly created `.patchtt.tt2` file:

```
root@spce:~# cat /etc/ngcp-config/templates/etc/kamailio/lb/kamailio.cfg.patchtt.tt2
@@ -1799,3 +1799,4 @@
}

# vim: ft=cfg
+# This is my last line comment
root@spce:~#
```

See more details about `.patchtt.tt2` files below in [patchtt](#) section.

Tip

The .tt2 files use the **Template Toolkit** language. Therefore you can use all the feature this excellent toolkit provides within ngcpcfg's template files (all the ones with the .tt2 suffix).

11.1.2 Using patchtt for generation of a relevant customtt file

Keeping custom modifications directly in the .customtt.tt2 templates is NOT recommended as templates become outdated with every software upgrade.

A better way is to handle custom modifications using .patchtt.tt2 files (e.g. /etc/ngcp-config/templates/etc/cron.d/cleanup-tools.patchtt.tt2). In this case, on every "ngcpcfg patch", a .patchtt.tt2 file will be applied on top of the .tt2 file and the result will be saved into the customtt file and used commonly as described in the previous section. "ngcpcfg patch" is the first step on "ngcpcfg build" that guarantees the latest upstream templates with the availability of the necessary local changes on every configuration apply.

Tip

The patch to be applied to the corresponding .tt2 template file is selected in the following order (highest to lowest):
*.patchtt.tt2.\$HOSTNAME *.patchtt.tt2.\$PAIRNAME *.patchtt.tt2.\$HA_NODE *.patchtt.tt2

Note

If a suitable patchtt file is found for a template, then the ngcpcfg patch command will overwrite the corresponding customtt file, if any.

11.1.2.1 Creating a patchtt file

Let us see how to introduce custom changes into a template through a patchtt file. For example, we need to change the accounting records cleanup time, which is defined in *cleanup-tools.tt2*. Here is how to do this:

- Go to the corresponding templates directory:

```
cd /etc/ngcp-config/templates/etc/cron.d/
```

- Duplicate the required .tt2 file to .customtt.tt2

```
cp ./cleanup-tools.tt2 ./cleanup-tools.customtt.tt2
```

- Introduce the necessary changes to the duplicated file:

```
vim ./cleanup-tools.customtt.tt2
```

- Create the patchtt file from your customtt file and recheck it:

```
ngcpcfg patch --from-customtt ./cleanup-tools.customtt.tt2
cat ./cleanup-tools.patchtt.tt2
```

- Apply and push the changes

```
ngcpcfg apply "Change acc-cleanup time from 00 to 02 hours"
ngcpcfg push all
```

You will notice that the "ngcpcfg apply" command has generated the customtt file for the corresponding template:

```
root@web01a:/etc/ngcp-config/templates/etc/cron.d# ls -l ./cleanup-tools*
-rw----- 1 root root 932 Jan  4 11:11 ./cleanup-tools.customtt.tt2
-rw-r--r-- 1 root root 630 Jan  4 11:08 ./cleanup-tools.patchtt.tt2
-rw-r--r-- 1 root root 932 Dec 18 15:09 ./cleanup-tools.tt2
```

Now, even if cleanup-tools.tt2 slightly changes after a software upgrade, "ngcpcfg apply" will still preserve your custom changes.

Note

If in a new release the .tt2 file gets changed in the same lines where you had introduced custom changes (e.g. your changes were temporary until a feature is implemented properly in a new software release), the apply process will fail and ask you to review the corresponding .patchtt.tt2 file. Then, check it and either correct if it is still required or remove it.

Tip

To convert all existing customtt files to patchtt files use the command: **ngcpcfg patch --from-customtt**

11.1.3 .prebuild and .postbuild files

After creating the configuration files, the configuration framework can execute some commands before and after placing that file in its target directory. These commands usually are used for changing the file's owner, groups, or any other attributes. There are some rules these commands need to match:

- They have to be placed in a *.prebuild* or *.postbuild* file in the same path as the original *.tt2* file.

- The file name must be the same as the configuration file, but having the mentioned suffixes.
- The commands must be *bash* compatible.
- The commands must return 0 if successful.
- The target configuration file is matched by the environment variable *output_file*.

Example: We need *www-data* as owner of the configuration file */etc/ngcp-ossbss/provisioning.conf*. The configuration framework will by default create the configuration files with *root:root* as owner:group and with the same permissions (*rwX*) as the original template. For this particular example, we will change the owner of the generated file using the *.postbuild* mechanism.

```
echo 'chgrp www-data ${output_file}' \  
> /etc/ngcp-config/templates/etc/ngcp-ossbss/provisioning.conf.postbuild
```

11.1.4 .services files

.services files are pretty similar and might contain commands that will be executed after the *build* process. There are two types of *.services* files:

- The particular one, with the same name as the configuration file it is associated to.
Example: */etc/ngcp-config/templates/etc/asterisk/sip.conf.services* is associated to */etc/asterisk/sip.conf*
- The general one, named *ngcpcfg.services* that is associated to every file in its target directory.
Example: */etc/ngcp-config/templates/etc/asterisk/ngcpcfg.services* is associated to every file under */etc/asterisk/*

When the *services* step is triggered all *.services* files associated to a changed configuration file will be executed. In case of the general file, any change to any of the configuration files in the directory will trigger the execution of the commands.

Tip

If the service script has the execute flags set (*chmod +X \$file*) it will be invoked directly. If it doesn't have execute flags set it will be invoked under *bash*. Make sure the script is *bash* compatible if you do not set execute permissions on the service file.

These commands are usually service reload/restarts to ensure the new configuration has been loaded by running services.

Note

The configuration files mentioned in the following example usually already exist on the platform. Please make sure you don't overwrite any existing files if following this example.

Example:

```
echo 'ngcp-service restart mariadb' \  
> /etc/ngcpcfg-config/templates/etc/mysql/my.cnf.services  
echo 'ngcp-service restart asterisk' \  
> /etc/ngcpcfg-config/templates/etc/asterisk/ngcpcfg.services
```

In this example we created two `.services` files. Now, each time we trigger a change to `/etc/mysql/my.cnf` or to `/etc/asterisk/*` we'll see that MySQL or Asterisk services will be restarted by the `ngcpcfg` system.

11.2 config.yml, constants.yml and network.yml files

The `/etc/ngcp-config/config.yml` file contains all the user-configurable options, using the **YAML** (YAML Ain't Markup Language) syntax.

The `/etc/ngcp-config/constants.yml` file provides configuration options for the platform that aren't supposed to be edited by the user. Do not manually edit this file unless you really know what you're doing.

The `/etc/ngcp-config/network.yml` file provides configuration options for all interfaces and IP addresses on those interfaces. You can use the `ngcp-network` tool for conveniently change settings without having to manually edit this file.

The `/etc/ngcp-config/ngcpcfg.cfg` file is the main configuration file for `ngcpcfg` itself. Do not manually edit this file unless you really know what you're doing.

11.3 ngcpcfg and its command line options

On a CARRIER the shared storage used by all nodes is the shared storage of the mgmt pair.

The `ngcpcfg` utility supports the following command line options:

11.3.1 apply

The `apply` option is a short-cut for the options "check && build && services && commit" and also executes `etckeeper` to record any modified files inside `/etc`. It is the recommended option to use the `ngcpcfg` framework unless you want to execute any specific commands as documented below.

11.3.2 build

The `build` option generates (and therefore also updates) configuration files based on their configuration (`config.yml`) and template files (`.tt2`). Before the configuration file is generated a present `.prebuild` will be executed, after generation of the configuration file the according `.postbuild` script (if present) will be executed. If a `file` or `directory` is specified as argument the build will generate only the specified configuration file/directory instead of running through all present templates.

Example: to generate only the file `/etc/nginx/sites-available/ngcp-panel` you can execute:

```
ngcpcfg build /etc/nginx/sites-available/ngcp-panel
```

Example: to generate all the files located inside the directory `/etc/nginx/` you can execute:

```
ngcpcfg build /etc/nginx/
```

11.3.3 commit

The *commit* option records any changes done to the configuration tree inside `/etc/ngcp-config`. The *commit* option should be executed when you've modified anything inside the configuration tree.

11.3.4 decrypt

Decrypt `/etc/ngcp-config-encrypted.tgz.gpg` and restore configuration files, doing the reverse operation of the *encrypt* option. Note: This feature is only available if the `ngcp-ngcpcfg-locker` package is installed.

11.3.5 diff

Show uncommitted changes between `ngcpcfg`'s Git repository and the working tree inside `/etc/ngcp-config`. If the tool doesn't report anything it means that there are no uncommitted changes. If the `--addremove` option is specified then new and removed files (iff present) that are not yet (un)registered to the repository will be reported, no further diff actions will be executed then. Note: This option is available since `ngcp-ngcpcfg` version 0.11.0.

11.3.6 encrypt

Encrypt `/etc/ngcp-config` and all resulting configuration files with a user defined password and save the result as `/etc/ngcp-config-encrypted.tgz.gpg`. Note: This feature is only available if the `ngcp-ngcpcfg-locker` package is installed.

11.3.7 help

The *help* options displays `ngcpcfg`'s help screen and then exits without any further actions.

11.3.8 initialise

The *initialise* option sets up the `ngcpcfg` framework. This option is automatically executed by the installer for you, so you shouldn't have to use this option in normal operations mode.

11.3.9 pull

Retrieve modifications from shared storage.

11.3.10 push

Push modifications to shared storage and remote systems. After changes have been pushed to the nodes the *build* option will be executed on each remote system to rebuild the configuration files (unless the *--nobuild* has been specified, then the build step will be skipped). If hostname(s) or IP address(es) is given as argument then the changes will be pushed to the shared storage and to the given hosts only. You can use *all* as a shortcut to push to the other nodes. If no host has been specified then the hosts specified in */etc/ngcp-config/systems.cfg* are used.

11.3.11 services

The *services* option executes the service handlers for any modified configuration file(s)/directory.

11.3.12 status

The *status* option provides a human readable interface to check the state of the configuration tree. If you are unsure what should be done as next step or if want to check the current state of the configuration tree just invoke *ngcpcfg status*.

If everything is OK and nothing needs to be done the output should look like:

```
# ngcpcfg status
Checking state of ngcpcfg:
OK:  has been initialised already (without shared storage)
Checking state of configuration files:
OK:  nothing to commit.
Checking state of /etc files
OK:  nothing to commit.
```

If the output doesn't say "OK" just follow the instructions provided by the output of *ngcpcfg status*.

Further details regarding the *ngcpcfg* tool are available through *man ngcpcfg* on the Sipwise Next Generation Platform.

12 Network Configuration

Starting with version 2.7, Sipwise C5 uses a dedicated *network.yml* file to configure the IP addresses of the system. The reason for this is to be able to access all IPs of all nodes for all services from any particular node in case of a distributed system on one hand, and in order to be able to generate */etc/network/interfaces* automatically for all nodes based on this central configuration file.

12.1 General Structure

The basic structure of the file looks like this:

```
hosts:
  self:
    role:
      - proxy
      - lb
      - mgmt
    interfaces:
      - eth0
      - lo
    eth0:
      ip: 192.168.51.213
      netmask: 255.255.255.0
      type:
        - sip_ext
        - rtp_ext
        - web_ext
        - web_int
    lo:
      ip: 127.0.0.1
      netmask: 255.255.255.0
      type:
        - sip_int
        - ha_int
```

Some more complete, sample configuration is shown in [network.yml Overview](#) section of the handbook.

The file contains all configuration parameters under the main key: `hosts`

In Sipwise C5 systems all hosts of the system are defined, and the names are the actual host names instead of *self*, like this:

On a PRO it would look like:

```
hosts:
```

```
sp1:
  peer: sp2
  role: ...
  interfaces: ...

sp2:
  peer: sp1
  role: ...
  interfaces: ...
```

On a CARRIER it would look like:

```
hosts:

web01a:
  peer: web01b
  role: ...
  interfaces: ...

web01b:
  peer: web01a
  role: ...
  interfaces: ...
```

12.1.1 Available Host Options

There are three different main sections for a host in the config file, which are *role*, *interfaces* and the actual interface definitions.

- *role*: The role setting is an array defining which logical roles a node will act as. Possible entries for this setting are:
 - *mgmt*: This entry means the host is acting as management node for the platform. In a Sipwise C5 system this option must always be set. The management node exposes the admin and CSC panels to the users and the APIs to external applications and is used to export CDRs. Please note: on a CARRIER this is only set on the nodes of the management pairs. This node is also the source of the installations of other nodes via iPXE and has the *approx* service (apt proxy).
 - *lb*: This entry means the host is acting as SIP load-balancer for the platform. In a Sipwise C5 system this option must always be set. Please note: on a CARRIER this is only set on the nodes of the *lb* pairs. The SIP load-balancer acts as an ingress and egress point for all SIP traffic to and from the platform.
 - *proxy*: This entry means the host is acting as SIP proxy for the platform. In a Sipwise C5 system this option must always be set. Please note: on a CARRIER this is only set on the nodes of the *proxy* pairs. The SIP proxy acts as registrar, proxy and application server and media relay, and is responsible for providing the features for all subscribers provisioned on it.
 - *db*: This entry means the host is acting as the database node for the platform. In a Sipwise C5 system this option must always be set. Please note: on a CARRIER this is only set on the nodes of the *db* pairs. The database node exposes the MySQL and Redis databases.

- *rtplib*: This entry means the host is acting as the RTP relay node for the platform. In a Sipwise C5 system this option must always be set. Please note: on a CARRIER this is only set on the nodes of the *RTP relay* pairs. The RTP relay node runs the *rtplib* Sipwise C5 component.
- *li*: (CARRIER-only) This entry means the host is acting as the interface towards a lawful interception service provider.
- *interfaces*: The *interfaces* setting is an array defining all interface names in the system. The actual interface details are set in the actual interface settings below. It typically includes `lo`, `eth0`, `eth1` physical and a number of virtual interfaces, like: `bond0`, `vlanXXX`
- *<interface name>*: After the interfaces are defined in the *interfaces* setting, each of those interfaces needs to be specified as a separate set of parameters.

Additional main parameters of a node:

- *dbnode*: the sequence number (unique ID) of the node in the database cluster;
- *peer*: the hostname of the peer node within the pair of nodes (e.g. "sp2" for *sp1* host on a PRO; "web01b" for *web01a* host on a CARRIER). The purpose of that: each node knows its companion for providing high availability, data replication etc.
- *status*: one of *online*, *offline*, *inactive*. *inactive* means that the node is up but is not ready to work in the cluster (installing process). *offline* means that the node is not reachable. *online* is a normal working node.

12.1.2 Interface Parameters

- *hwaddr*: MAC address of the interface



Caution

On a CARRIER this *must* be filled in properly for the interface that is used as type `ha_int`, because the value of it will be used during the boot process of the installation of nodes via iPXE, if PXE-boot is enabled.

- *ip*: IPv4 address of the node
- *v6ip*: IPv6 address of the node; optional
- *netmask*: IPv4 netmask
- *v6netmask*: IPv6 netmask
- *gateway*: IPv4 gateway address
- *v6gateway*: IPv6 gateway address
- *shared_ip*: shared IPv4 address of the pair of nodes; this is a list of addresses
- *shared_v6ip*: shared IPv6 address of the pair of nodes; optional; this is a list of addresses
- *shared_ip_only*: Boolean switch (*yes* or *no*) to enable usage with just a shared floating IPv4 address, without a static IPv4 address configured. To prevent accidental misconfiguration, this usage mode must be explicitly enabled. This usage mode is disallowed for certain interface types (e.g. *ssh*, *mon*, or *ha*).

- `shared_v6ip_only`: same as above, but for IPv6
- `advertised_ip`: the IP address that is used in SIP messages when Sipwise C5 system is behind NAT/SBC. An example of such a deployment is *Amazon AMI*, where the server doesn't have a public IP, so *load-balancer* component of Sipwise C5 needs to know what his public domain is (→ `advertised_ip`).
- `type`: type of services that the node provides; these are usually the VLANs defined for a particular Sipwise C5 system.

Note

You can assign a type only once per node.

Available types are:

- `api_int`: internal, API-based communication interface. It is used for the internal communication of such services as *faxserver*, *fraud detection* and others.
- `aux_ext`: interface for potentially insecure external components like remote system log collection service.

Note

For example the *CloudPBX* module can use it to provide time services and remote logging facilities to end customer devices. The type `aux_ext` is assigned to `lo` interface by default. If it is needed to expose this type to the public, it is recommended to assign the type `aux_ext` to a separate VLAN interface to be able to limit or even block the incoming traffic easily via firewalling in case of emergency, like a (D)DoS attack on external services.

- `mon_ext`: remote monitoring interface (e.g. SNMP)
- `rtp_ext`: main (external) interface for media traffic
- `sip_ext`: main (external) interface for SIP signalling traffic between NGCP and other SIP endpoints
- `sip_ext_incoming`: additional, optional interface for incoming SIP signalling traffic
- `sip_int`: internal SIP interface used by Sipwise C5 components (*lb*, *proxy*, *etc.*)
- `ssh_ext`: command line (SSH) remote access interface
- `ssh_int`: command line (SSH) internal NGCP access interface
- `web_ext`: interface for web-based or API-based provisioning and administration
- `web_int`: interface for the administrator's web panel, his API and generic internal API communication
- `li_int`: used for LI (Lawful Interception) traffic routing
- `ha_int`: HA (High Availability) communication interface between the services
- `boot_int`: the default VLAN used to install nodes via PXE-boot method
- `rtp_int`: internal interface for handling RTP traffic among Sipwise C5 nodes that may reside in greater distance from each other, like in case of a specialised NGCP configuration with centralized web / DB / proxy nodes and distributed LB nodes. (Please refer to [Cluster Sets](#) section for further details)

Note

Please note that, apart from the standard ones described so far, there might be other *types* defined for a particular Sipwise C5 system.

- `vlan_raw_device`: tells which physical interface is used by the particular VLAN
- `post_up`: routes can be defined here (interface-based routing), for example:

```
post_up:
- route add -host 1.2.3.4 gw 192.168.1.1 dev vlan70
- route add -net 10.11.12.0/21 gw 192.168.1.2 dev vlan300
- route del -host 1.2.3.4 gw 192.168.1.1 dev vlan70
- route del -net 10.11.12.0/21 gw 192.168.1.2 dev vlan300
```

- `bond_XY`: specific to "bond0" interface only; these contain Ethernet bonding properties

12.2 Advanced Network Configuration

You have a typical deployment now and you are good to go, however you may need to do extra configuration depending on the devices you are using and functionality you want to achieve.

12.2.1 Additional entries in `/etc/hosts`

The file `/etc/hosts` is generated by a template, containing entries for basic host configuration (localhost and basic IPv4/IPv6), and the IPs of other nodes in PRO/CARRIER configurations.

To add extra entries in this file, it can be done in several ways:

- `etc_hosts_global_extra_entries` at the global level, added to all hosts
- `etc_hosts_global_extra_entries` at the host level, which overrides the global one if for some reason the whole content is undesired for a particular host (e.g. to have some but not all of the "default" global entries)
- `etc_hosts_local_extra_entries` at the host level, which are added only to the hosts where this entry is present, if for some reason it is desired to have extra entries only visible in some subset of the hosts

The behaviour is the same in all cases, to append the entries directly to `/etc/hosts`.

Example of both in a configuration file:

```
---
hosts_common:
  etc_hosts_global_extra_entries:
  - 10.100.1.1 server-1 server-1.internal.example.com
  - 10.100.1.2 server-2 server-2.internal.example.com
hosts:
  db01b:
```

```

etc_hosts_local_extra_entries:
- 127.0.1.1 local-alias-1.db01b
- 127.0.2.1 local-alias-2.db01b
- 172.30.52.180 db01b.example.com
...
web01a:
etc_hosts_local_extra_entries:
- 127.0.1.1 local-alias-1.web01a
- 127.0.2.1 local-alias-2.web01a
- 172.30.52.168 web01a.example.com
etc_hosts_global_extra_entries:
- 10.100.1.1 server-1 server-1.internal.example.com
...

```

With this, the additional output in `/etc/hosts` for `db01b` will be:

```

# local extra entries for host 'db01b'
127.0.1.1 local-alias-1.db01b
127.0.2.1 local-alias-2.db01b
172.30.52.180 db01b.example.com

# global extra entries
10.100.1.1 server-1 server-1.internal.example.com
10.100.2.1 server-2 server-2.internal.example.com

```

and in `web01a`:

```

# local extra entries for host 'web01a'
127.0.1.1 local-alias-1.web01a
127.0.2.1 local-alias-2.web01a
172.30.52.168 web01a.example.com

# global extra entries overridden for host 'web01a'
10.100.1.1 server-1 server-1.internal.example.com

```

12.2.2 Extra SIP Sockets

By default, the load-balancer listens on the UDP and TCP ports 5060 (*kamailio*→*lb*→*port*) and TLS port 5061 (*kamailio*→*lb*→*tls*→*port*). If you need to setup one or more extra SIP listening ports or IP addresses in addition to those standard ports, please edit the *kamailio*→*lb*→*extra_sockets* option in your `/etc/ngcp-config/config.yml` file.

The correct format consists of a label and value like this:

```
extra_sockets:
  port_5064: udp:10.15.20.108:5064
  test: udp:10.15.20.108:6060
```

The label is shown in the `outbound_socket` peer preference (if you want to route calls to the specific peer out via specific socket); the value must contain a transport specification as in example above (udp, tcp or tls). After adding execute `ngcpcfg apply`:

```
ngcpcfg apply 'added extra socket'
ngcpcfg push all
```

The direction of communication through this SIP extra socket is incoming+outgoing. The Sipwise C5 will answer the incoming client registrations and other methods sent to the extra socket. For such incoming communication no configuration is needed. For the outgoing communication the new socket must be selected in the `outbound_socket` peer preference. For more details read the next section Section [12.2.3](#) that covers peer configuration for SIP and RTP in greater detail.



Important

In this section you have just added an extra SIP socket. RTP traffic will still use your `rtp_ext` IP address.

12.2.3 Extra SIP and RTP Sockets

If you want to use an additional interface (with a different IP address) for SIP signalling and RTP traffic you need to add your new interface in the `/etc/network/interfaces` file. Also the interface must be declared in `/etc/ngcp-config/network.yml`.

Suppose we need to add a new SIP socket and a new RTP socket on VLAN 100. You can use the `ngcp-network` tool for adding interfaces without having to manually edit this file: On a PRO system that would be:

```
ngcp-network --set-interface=eth0.100 --host=sp1 --ip=auto --netmask=auto --hwaddr=auto -- ←
  type=sip_ext_incoming --type=rtp_int_100
ngcp-network --set-interface=eth0.100 --host=sp2 --ip=auto --netmask=auto --hwaddr=auto -- ←
  type=sip_ext_incoming --type=rtp_int_100
```

On a CARRIER system that would be:

```
ngcp-network --set-interface=eth0.100 --host=lb01a --ip=auto --netmask=auto --hwaddr=auto ←
  --type=sip_ext_incoming
ngcp-network --set-interface=eth0.100 --host=lb01b --ip=auto --netmask=auto --hwaddr=auto ←
  --type=sip_ext_incoming
ngcp-network --set-interface=eth0.100 --host=prx01a --ip=auto --netmask=auto --hwaddr=auto ←
  --type=rtp_int_100
```



```
ngcp-network --set-interface=eth0.100 --host=prx01b --ip=auto --netmask=auto --hwaddr=auto ←  
--type=rtp_int_100
```

On a PRO system the generated files would look like:

```
sp1:  
..  
..  
  eth0.100:  
    hwaddr: ff:ff:ff:ff:ff:ff  
    ip: 192.168.1.2  
    netmask: 255.255.255.0  
    shared_ip:  
      - 192.168.1.3  
    shared_v6ip: ~  
    type:  
      - sip_ext_incoming  
      - rtp_int_100  
..  
..  
  interfaces:  
    - lo  
    - eth0  
    - eth0.100  
    - eth1  
..  
..  
sp2:  
..  
..  
  eth0.100:  
    hwaddr: ff:ff:ff:ff:ff:ff  
    ip: 192.168.1.4  
    netmask: 255.255.255.0  
    shared_ip:  
      - 192.168.1.3  
    shared_v6ip: ~  
    type:  
      - sip_ext_incoming  
      - rtp_int_100  
..  
..  
  interfaces:  
    - lo  
    - eth0  
    - eth0.100
```

```
- eth1
```

On a CARRIER system the generated files would look like:

```
lb01a:
..
..
  eth0.100:
    hwaddr: ff:ff:ff:ff:ff:ff
    ip: 192.168.1.2
    netmask: 255.255.255.0
    shared_ip:
      - 192.168.1.3
    shared_v6ip: ~
    type:
      - sip_ext_incoming
..
..
  interfaces:
    - lo
    - eth0
    - eth0.100
    - eth1
..
..
prx01a:
..
..
  eth0.100:
    hwaddr: ff:ff:ff:ff:ff:ff
    ip: 192.168.1.20
    netmask: 255.255.255.0
    shared_ip:
      - 192.168.1.30
    shared_v6ip: ~
    type:
      - rtp_int_100
..
..
  interfaces:
    - lo
    - eth0
    - eth0.100
    - eth1
..
..
```

```
lb01b:
..
..
  eth0.100:
    hwaddr: ff:ff:ff:ff:ff:ff
    ip: 192.168.1.4
    netmask: 255.255.255.0
    shared_ip:
      - 192.168.1.3
    shared_v6ip: ~
    type:
      - sip_ext_incoming
..
..
  interfaces:
    - lo
    - eth0
    - eth0.100
    - eth1
..
..
prx01b:
..
..
  eth0.100:
    hwaddr: ff:ff:ff:ff:ff:ff
    ip: 192.168.1.40
    netmask: 255.255.255.0
    shared_ip:
      - 192.168.1.30
    shared_v6ip: ~
    type:
      - rtp_int_100
..
..
  interfaces:
    - lo
    - eth0
    - eth0.100
    - eth1
```

As you can see from the above example, extra SIP interfaces must have type *sip_ext_incoming*. While *sip_ext* should be listed only once per host, there can be multiple *sip_ext_incoming* interfaces. The direction of communication through this SIP interface is incoming only. The Sipwise C5 will answer the incoming client registrations and other methods sent to this address and remember the interfaces used for clients' registrations to be able to send incoming calls to him from the same interface.

In order to use the interface for the outbound SIP communication it is necessary to add it to *extra_sockets* section in */etc/ngcp-*

`config/config.yml` and select in the `outbound_socket` peer preference. So if using the above example we want to use the `vlan100` IP as source interface towards a peer, the corresponding section may look like the following:

```
extra_sockets:
  port_5064: udp:10.15.20.108:5064
  test: udp:10.15.20.108:6060
  int_100: udp:192.168.1.3:5060
```

The changes have to be applied:

```
ngcpcfg apply 'added extra SIP and RTP socket'
ngcpcfg push all
```

After applying the changes, a new SIP socket will listen on IP `192.168.1.3` on a CARRIER in the `lb01` node and this socket can now be used as source socket to send SIP messages to your peer for example. In above example we used label `int_100`. So the new label "int_100" is now shown in the `outbound_socket` peer preference.

Also, RTP socket is now listening on `192.168.1.3` on a PRO, and `192.168.1.30` on a CARRIER `prx01` node and you can choose the new RTP socket to use by setting parameter `rtp_interface` to the Label "int_100" in your Domain/Subscriber/Peer preferences.

12.2.4 Alternative RTP Interface Selection Using ICE

Normally, each interface that was configured with a type that starts with `rtp_` can be selected individually as RTP interface in the Domain/Subscriber/Peer preferences. For example, if the interface types `rtp_ext`, `rtp_int`, and `rtp_int_100` have been configured, the Domain/Subscriber/Peer preferences will allow the RTP interfaces to be selected as either `ext`, `int`, or `int_100` in addition to "default".

The same `rtp_` interface type can be configured on multiple interfaces. If this is the case, and if ICE (*Interactive Connectivity Establishment*) is enabled for a Domain/Subscriber/Peer, it is possible to use ICE to automatically negotiate which interface should be used for RTP communications. ICE must be supported by the remote client for this to work.

For example, `rtp_ext` can be configured on multiple interfaces like so (abbreviated):

```
..
..
  eth0.100:
    type:
      - rtp_ext
..
  eth0.150:
    type:
      - rtp_ext
```

```
..
  eth1:
    type:
      - rtp_ext
..
..
```

In this example, the RTP interface `ext` will be available for selection in the Domain/Subscriber/Peer preferences. If selected and if ICE is enabled, the addresses of all three interfaces will be presented to the remote client, and ICE will be used to negotiate which one of them will be used for communications. This can be useful in multi-homed environments, or when remote clients are on private networks.

12.2.5 Extended RTP Port Range Using Multiple Interfaces

If the RTP port range configured via the `config.yml` keys `rtpproxy.minport` and `rtpproxy.maxport` is not sufficient to handle all concurrent calls, it is possible to load-balance the RTP ports across multiple interfaces. This is useful if the RTP proxy runs out of ports and if not enough additional ports are available.

To enable this, multiple interfaces with different addresses must be configured, and interface types of the format `rtp_NAME:SUFFIX` must be assigned to them. For example, if the RTP interface named `ext` should be load-balanced across three interfaces, they can be configured like so (abbreviated):

```
..
..
  eth0.100:
    type:
      - rtp_ext:1
..
  eth0.150:
    type:
      - rtp_ext:2
..
  eth1:
    type:
      - rtp_ext:3
..
..
```

In this example, all three given RTP interface types will be available for selection in the Domain/Subscriber/Peer preferences individually (as `ext:1` and so on), but in addition to that, an interface named just `ext` will also be available for selection. If `ext` is selected, only one of the three RTP interfaces will be selected in a round-robin fashion, thus increasing the number of available RTP ports threefold. The round-robin algorithm only selects an interface if it actually has RTP ports available.

12.2.6 Cluster Sets

In a Sipwise C5 CARRIER system it is possible to have geographically distributed nodes in the same logical Sipwise C5 unit. Such a configuration typically involves the following elements:

- **centralised** management (*web*), database (*db*) and proxy (*prx*) nodes: these provide all higher level functionality, like system administration, subscriber registration, call routing, etc.
- **distributed** load balancer (*lb*) nodes: these serve as SBCs for the whole Sipwise C5 and handle SIP and RTP traffic to / from SIP endpoints (e.g. subscribers); and they also communicate with the central elements of Sipwise C5 (e.g. proxy nodes)

In case of such an Sipwise C5 node configuration it is possible to define *cluster sets* which are collections of Sipwise C5 nodes providing the load balancer functionality.

Cluster sets can be assigned to subscriber *domains* or *SIP peers* and will determine the route of SIP and RTP traffic for those sets of SIP endpoints:

- For *SIP peers* the selected nodes will be used to send outbound SIP traffic through
- For both *SIP peers* and subscriber *domains* the selected nodes will provide RTP relay functionality (the *rtengine* Sipwise C5 component will run on those nodes)

12.2.6.1 Configuration of Nodes of Cluster Sets

There are 2 places in NGCP's main configuration files where an entry for cluster sets must be inserted:

1. Declaration of cluster sets

This happens in `/etc/ngcp-config/config.yml` file, see an example below:

```
cluster_sets:
  default:
    dispatcher_id: 50
    default_set: default
  poland:
    dispatcher_id: 51
  type: distributed
```

Configuration entries are:

- `<label>`: an arbitrary label of the cluster set; in the above example we have 2 of them: `default` and `poland`; the cluster set `default` is always defined, even if cluster sets are not used
- `<label>.dispatcher_id`: a unique, numeric value that identifies a particular cluster set
- `default_set`: selects the default cluster set
- `type`: the type of cluster set; can be `central` or `distributed`

2. Assignment of cluster sets

This happens in `/etc/ngcp-config/network.yml` file, see an example below:

```
.
.
lb03a:
.
.
vlan792:
  cluster_sets:
    - poland
  hwaddr: 00:00:00:00:00:00
  ip: 172.30.61.37
  netmask: 255.255.255.240
  shared_ip: 172.30.61.36
  type:
    - sip_int
  vlan_raw_device: bond0
```

In the network configuration file typically the load balancer (*lb*) nodes are assigned to cluster sets. More precisely: network interfaces of load balancer nodes that have `sip_int` type—that are used for SIP signalling and NGCP's internal *rtengine* command protocol—are assigned to cluster sets.

In order to do such an assignment a cluster set's label has to be added to the `cluster_sets` parameter, which is a list.

After modifying network configuration with cluster sets, the new configuration must be applied in the usual way:

```
> ngcpcfg apply 'Added cluster sets'
> ngcpcfg push all
```

12.2.6.2 Configuration of Cluster Sets for SIP and RTP Traffic

For both SIP peers and subscriber domains you can select the cluster set labels predefined in `config.yml` file.

- **SIP peers:** In order to select a particular cluster set for a SIP peer you have to navigate to *Peerings* → *select the peering group* → *select the peering server* → *Preferences* → *NAT and Media Flow Control* and then *Edit lbrtp_set* parameter.

Peer Host "Vlada01" - Preferences

← Back ★ Flash Dialogic [Expand Groups](#)

Access Restrictions

Number Manipulations

NAT and Media Flow Control

Attribute	Name	Value	
use_rtpproxy	RTP-Proxy Mode	Always with plain SDP	
ipv46_for_rtpproxy	IPv4/IPv6 bridging mode	Auto-detect	
lbrtp_set	The cluster set used for SIP lb and RTP	None	Edit
rtp_interface	RTP interface	default	

Figure 118: Select Cluster Set for a Peer

- **Domains:** In order to select a particular cluster set for a domain you have to navigate to *Domains* → *select the domain* → *Preferences* → *NAT and Media Flow Control* and then *Edit lbrtp_set* parameter.

Domain "195.185.37.60" - Preferences

[← Back](#)

[Expand Groups](#)

Call Blockings

Access Restrictions

Number Manipulations

NAT and Media Flow Control

Attribute	Name	Value	
sound_set	System Sound Set	<input type="text" value=""/>	
no_nat_sipping	Disable NAT SIP pings	<input type="checkbox"/>	
use_rtpproxy	RTP-Proxy Mode	Always with plain SDP	
ipv46_for_rtpproxy	IPv4/IPv6 bridging mode	Auto-detect	
bypass_rtpproxy	Disable RTP-Proxy in the selected case	Never	
lbrtp_set	The cluster set used for SIP lb and RTP	None	Edit
rtp_interface	RTP Interface	default	

Figure 119: Select Cluster Set for a Domain

13 Licenses

The Sipwise C5—starting from mr5.5.1 release—implements *software licensing* in form of a regular comparison of the licensed services and capacities against the actual usage patterns of the platform. The purpose of this function is to monitor system usage and to raise warnings to the platform operator if the thresholds of commercially agreed license parameters (like number of provisioned subscribers or number of concurrent calls) are exceeded.

13.1 What is Subject to Licensing?

Sipwise C5 licenses determine 2 groups of system parameters which are regularly compared with actual values gathered from the system:

- **performance parameters:**
 - number of provisioned subscribers
 - number of registered subscribers
 - number of concurrent calls
- **feature parameters:** additional features / services that are subject to commercial agreement:
 - pre-paid billing
 - CPBX (Cloud PBX) services
 - Push notifications (mobile SIP clients on iOS and Android)
 - Lawful Interception services
 - SIP capturing via ngcp-voisniff

13.2 How Licensing Works

Sipwise operates a *licensing server* that is the source of license data for each deployed Sipwise C5 node. The nodes themselves request licensing data from the license server regularly and compare them with actual system performance indicators, check the activated features against the licensed ones. The presence and activity of the *license client* module ("licensed" process) may be confirmed by checking e.g. the output of "ngcp-service summary" command. It should contain a line showing:

```
ngcp-license-client          managed    on-boot    active
```

All nodes of a single Sipwise C5 installation share the same license key. This is also valid for geographically distributed setups. This license key is referred by an ID that has to be configured in the main Sipwise C5 configuration file (config.yml), and that ID will be used to request license data from the license server.

In order for the license validation to work each node of an Sipwise C5 installation must be able to connect to the Sipwise license server via standard HTTPS protocol (TCP, port 443). Alternatively the nodes may use a local, system-wide proxy server and only that proxy server needs to access the Sipwise license server.

13.3 How to Configure Licenses

The Sipwise C5 operator can set the **license key** in the main configuration file (`/etc/ngcp-config/config.yml`). The correct license key has to be entered in the configuration file, at the **general.license_key** configuration parameter, so that licensing works as expected.

Tip

You always have to add the license key before being able to upgrade Sipwise C5 to release mr5.5.x or above. The upgrade script will look for the license key and will stop if it does not find the key.

The license key is also shown in the `/etc/ngcp-license-key` file once the key has been added to the configuration file and the new configuration has been applied.

Note

There is another configuration parameter related to licenses: `general.anonymous_usage_statistics` that has an effect on Sipwise C5 CE installations only. This parameter enables / disables sending anonymous usage statistics to Sipwise.

Although not strictly related to Sipwise C5 configuration, the platform operator has to keep in mind that all Sipwise C5 nodes need to have **access to Sipwise license server**: `license.sipwise.com`

The operator has to ensure that there is no firewall rule or other network configuration that prevents Sipwise C5 nodes from connecting to Sipwise license server via HTTPS protocol (TCP, port 443).

13.4 How to Monitor License Client

As mentioned earlier in this chapter, the presence of license client can be monitored using the built-in utility `ngcp-service`.

The other way to observe the behaviour of the license client is looking into the log file of "licensed" process: `/var/log/ngcp/lic`

The Sipwise C5 operator may find entries like the below ones in case of normal operation:

```
Dec 12 16:20:42 sp1 ngcp-licensed[2205]: Valid license: [ABCDEFGH1_123456789_a1b2c3d4e5f6]:
  10000 calls, 1000000 subscribers, 2000000 registered subscribers, valid until Tue Jan 1
  00:00:00 2030 (signature valid until Tue Dec 26 16:20:43 2017)
Dec 12 16:22:41 sp1 ngcp-licensed[2205]: Usage report: 0 calls, 18 subscribers, 0 ←
  registered subscribers
```

where:

1. The first line shows *the licensed capacities*
2. The second line shows *the actual system usage indicators*

14 Software Upgrade

14.1 Release Notes

Please find the complete release notes and changelog of Sipwise C5 version mr8.5.9 [on our WEB site](#).

14.2 Overview

The Sipwise C5 software upgrade procedure to mr8.5.9 will perform several fundamental tasks:

- upgrade the NGCP software packages
- upgrade the NGCP configuration templates
- upgrade the NGCP DB schema
- upgrade the NGCP configuration schema
- upgrade the base system within Debian 10 (buster) to the latest package versions

Sipwise C5 CARRIER is a PRO-style system that has "A" and "B" sets of nodes with specific roles. The number of nodes can differ between installations and must be clarified before the upgrade at the planning stage.

The software upgrade is usually performed by Sipwise engineers according to the following steps:

- create the software upgrade plan
- execute pre-upgrade steps: patchtt, customtt, backups
- make all "B" nodes (on CARRIER) or the sp2 node (on PRO) active
- ensure that all "A" nodes (on CARRIER) or the sp1 node (on PRO) are standby
- perform the software upgrade on all "A" nodes (on CARRIER) or the sp1 node (on PRO)
- schedule and make services switchover to all "A" nodes (on CARRIER) or the sp1 node (on PRO)
- ensure that "A" nodes (on CARRIER) or the sp1 node (on PRO) perform well (otherwise, perform a switch back)
- perform the software upgrade on all "B" nodes (on CARRIER) or the sp2 node (on PRO)
- perform the system post-upgrade testing and cleanup



Warning

The only allowed software upgrade path is the one described above. The nodes sp1/s2 (or a/b) MUST be used as described in this document. All the other theoretically possible upgrade scenarios can lead to unpredictable results.

14.3 Planning a software upgrade

Confirm the following information:

- which system should be upgraded (LAB/LIVE, country, etc.)
- the date and time schedule for each of the steps above (keeping the time zone in mind)
- a confirmed timeframe for the upgrade operation (allowed switchover timeframe)
- the basic functionality test (BFT) to be executed before the start of the software upgrade and after the switchovers to ensure that the new release does not show critical issues (the BFT scenario should be prepared by the customer engineers)
- actions to be taken if the software upgrade operation cannot be completed within the defined maintenance window
- contact persons and ways of communication in case of emergency
- ensure that the customer and/or Sipwise engineers have access to the virtual consoles of the servers: KVM, iDRAC, AMM

14.4 Pre-upgrade checks

It is recommended to execute the preparatory steps in this chapter a few days before the actual software upgrade. They do not cause a service downtime, so it is safe to execute them during peak hours.

14.4.1 Log into the C5 standby management node

This should be web01a on CARRIER and sp1 on PRO.

Tip

Use the static server IP address so you can switch between the nodes.

Run the terminal multiplexer under the *sipwise* user (to reuse the Sipwise `.screenrc` settings that are convenient for working in multiple windows):

```
screen -S my_screen_name_for_ngcp_upgrade
```

Become root inside your screen session:

```
sudo -s
```

14.4.2 Check the overall system status

Check the overall system status:

```
ngcp-status --all
```

Make sure that the cluster health status is OK: Check the nodes in parallel, using the clish command:

- **ngcp-clish "ngcp version summary"** - ensure that all cluster nodes have correct/expected from version
- **ngcp-clish "ngcp version package installed ngcp-ngcp-pro"** - (PRO-only) ensure that the metapackages version is equal to the ngcp version above
- **ngcp-clish "ngcp version package installed ngcp-ngcp-carrier"** - (CARRIER-only) ensure that the metapackages version is equal to the ngcp version above
- **ngcp-clish "ngcp version package check"** - ensure that all nodes have the identical Debian package installed

Note

Software must be identical on all nodes (before and after the upgrade!)

- **ngcp-clish "ngcp cluster ssh connectivity"** - check SSH connectivity from the current node to all other nodes
- **ngcp-clish "ngcp cluster ssh crossconnectivity"** - check SSH cross-connectivity from all nodes to all other nodes
- **ngcp-clish "ngcp service summary"** - all required services must be running on corresponding nodes
- **ngcp-clish "ngcp cluster status"** - active node(s) (with all services running) must print "active", the other(s) must print "standby"
- **ngcp-clish "ngcp status collective-check"** - all checks must be OK
- **ngcp-clish "ngcp show date"** - date and time must be in sync on all the servers
- **ngcp-clish "ngcp show dns-servers"** - ensure that the DNS configuration is consistent among the nodes
- **ngcp-clish "ngcp cluster replication"** - check all MySQL replications statuses on all nodes.

Note

to exit from *ngcp-clish* press Ctrl+Z (or type *exit*):

```
# ngcp-clish
Entering 'clish-enable' view (press Ctrl+Z to exit)...
# exit
#
```

14.4.3 Check access to license server and license validity

Check from within the system (better *from all nodes*, for extra safety) that the license server is accessible from the network point of view, and that these commands do not end with timeouts or HTTP errors:

```
ping -c 3 -w 5 license.sipwise.com

curl --head https://license.sipwise.com/
```

Also ensure that:

- `/proc/ngcp/check` contains the string "ok" (if not, check logs)
- and that there are no errors or important warnings in `/ngcp-data/logs/licensed.log (/var/log/ngcp/licensed.log` in systems before mr6.5).

14.4.4 Evaluate and update custom modifications

For the below steps, investigate and make sure you understand why the custom modifications were introduced and if they are still required after the software upgrade. If the custom modifications are not required anymore, remove them (e.g. if a bug was fixed in the target release and the existing patch becomes irrelevant).

Create tickets to Sipwise developers to make relevant custom modifications part of the product in future releases. This allows you to get rid of the customtt files one day.



Warning

If you directly change the working configuration (e.g. add custom templates or change the existing ones) for some reason, then the system must be thoroughly tested after these changes have been applied. Continue with the software upgrade preparation only if the results of the tests are acceptable.

Find the local changes to the template files:

```
ngcp-customtt-diff-helper
```

The script will also ask you if you would like to download the templates for your target release. To download the new templates separately, execute:

```
ngcp-customtt-diff-helper -d
```

In the tmp folder provided by the script, you can review the patchtt files or merge the current customtt with the new tt2 templates, creating the new customtt.tt2 files. Once you do this, archive the new patchtt/customtt files to reapply your custom modifications after the software upgrade:

```
ngcp-customtt-diff-helper -t
```

Find all available script options with the "-h" parameter.

14.4.5 Check system integrity

Check if there are any *.tt2.dpkg-dist files among the templates. They usually appear when tt2 files are modified directly instead of creating customtt/patchtt files. If you find any *.tt2.dpkg-dist files, treat the corresponding tt2 files as if they were customtt.tt2 and introduce the changes from the existing tt2 files into the new templates (create associated customtt.tt2 or patchtt.tt2) before the software upgrade.

```
find /etc/ngcp-config -name \*.tt2.dpkg-dist
```

Note that in the end all *.tt2.dpkg-dist files must be removed before the software upgrade as they prevent the upgrade script from updating the tt2 files.

Check and remove dpkg files left from previous software upgrades.

Make sure that the list is empty before you continue:

```
find /etc/ngcp-config -name \*.tt2.dpkg\*
```

Log into all the servers.

Open separate windows for all the servers inside your "screen" session. (Press `Ctrl+a + c` to open a new window, `Ctrl+a + a` or `Ctrl+a + [0-9]` to change the window. `Ctrl+a + "` shows the list of all your windows. Use `Ctrl+a + A` to change the window names to corresponding hosts).

Changes made directly in tt2 templates will be lost after the software upgrade. Only custom changes made in customtt.tt2 or added by patchtt.tt2 files will be kept. Hence, check the system for locally modified tt2 files on **all** nodes:

```
ngcp-status --integrity
```

14.4.6 Check the configuration framework status

Check the configuration framework status on **all** nodes. All checks must show the "OK" result and there must be no actions required:

```
ngcpcfg status
```

On a CARRIER, check the replication on both central DB servers and on ports 3306 and 3308 of all the proxy servers. Ensure that all the proxy nodes replicate the read-only DB (127.0.0.1:3308) from the db01a node. Otherwise, discuss a special plan to address your particular configuration.

On a PRO, check the replication on both nodes.

The result must always show:

```
Slave_IO_Running: Yes
Slave_SQL_Running: Yes
Seconds_Behind_Master: 0
```

Test the cluster failover to see if everything works fine as well on "B" nodes (on a CARRIER) or the second node (on a PRO). On all the standby nodes execute:

```
ngcp-make-active
```

Create two test subscribers or use the credentials for existing ones. Register subscribers with the platform and perform a test call to ensure that call routing and media flow are working fine.

Run "apt-get update" on **all** nodes and ensure that you do not have any warnings and errors in the output.



Warning

If the installation uses locally specified mirrors, then the mirrors must be switched to the Sipwise APT repositories (at least for the software upgrade). Otherwise, the public Debian mirrors may not provide packages for old Releases anymore or at least provide outdated ones!

14.4.7 Check access to deb.sipwise.com

Ensure that both management nodes have access to deb.sipwise.com by executing the following commands on a management node:

```
ngcp-approx-cache-helper --check --node sp1

ngcp-approx-cache-helper --check --node sp2
```

The checks must show only *200 OK* results. If you see *cannot connect!*, *Received 404* or any other error, check these possible causes:

- A node does not have a connection to deb.sipwise.com
- The deb.sipwise.com whitelist does not have the node's public IP (IPv6) address.

14.4.8 License check

The Sipwise C5—starting from mr6.5.1 release—enforce *software licensing* restrictions in form of a regular comparison of the licensed services and capacities against the actual usage patterns of the platform. In case some functionalities are enabled but not licensed, an error in *syslog* will be reported and the impacted services will be automatically deactivated.

Before proceeding with the upgrade, please take some time to check that all the modules not licensed are actually disabled in *config.yml* file. To verify if they are enabled execute the following commands:

```
ngcpcfg get sems.prepaid.enable
ngcpcfg get sems.prepaid.inew.enable
ngcpcfg get pbx.enable
ngcpcfg get pushd.enable
ngcpcfg get intercept.enable
ngcpcfg get voisniff.admin_panel
ngcpcfg get voisniff.daemon.li_x1x2x3.enable
ngcpcfg get voisniff.daemon.start
```

If the output of one of the commands is *yes* but the module is not licensed, you have to deactivate it. For example, in case of *pre-paid billing* module execute:

```
ngcpcfg set /etc/ngcp-config/config.yml sems.prepaid.enable=no
ngcpcfg apply 'Disable prepaid module'
ngcpcfg push all
```



Warning

Please, pay particular attention to *pre-paid billing* module because it is enabled by default.

14.5 Pre-upgrade steps

Note

Sipwise C5 can be upgraded to mr8.5.9 from previous release or previous build only. The script `ngcp-upgrade` will find all the possible destination releases for the upgrade and makes it possible to choose the proper one.

Note

If there is an error during the upgrade, the `ngcp-upgrade` script will request you to solve it. Once you've fixed the problem, just execute `ngcp-upgrade` again and it will continue from the previous step.

The upgrade script will ask you to confirm that you want to start. Read the given information **carefully**, and if you agree, proceed with *y*.

The upgrade process will take several minutes, depending on your network connection and server performance. After everything has been updated successfully, it will finally ask you to reboot your system. Confirm to let the system reboot (it will boot with an updated kernel).

14.5.1 `ngcp-upgrade` options

The following options in `ngcp-upgrade` can be specially useful in some instances of upgrade:

- **`--step-by-step`**: confirm before proceeding to next step. With this option the upgrade operation is performed confirming every step before execution, with the possibility to instruct to continue without confirming further steps until the end (if confirmation is only needed for some steps at the beginning).
- **`--pause-before-step STEP_NAME`**: pause execution before step, given by the name of the script (e.g. "backup_mysql_db"). This option can be useful in several scenarios, for example:
 - to help to debug problems or work around known problems during upgrades. In this case the operator can pause at a given step known to be problematic or just before a problematic set, perform some manual checks or changes, then continue the upgrade until another step (with confirmation like with the recent option `--step-by-step`), or just continue without stop until the end
 - another use might be to help to speed up upgrades when it involves several nodes: they can all proceed in parallel when it's known to be safe to do so; then perform some parts in lock-step (some nodes waiting until others finish with some stage); then continue in parallel until the end
- **`--skip-db-backup`**: This will speed-up the process in cases where it's deemed unnecessary, and this is very likely in the upgrade of nodes other than the first.

14.5.2 Preparing for maintenance mode

Sipwise C5 introduces **Maintenance Mode** with its mr5.4.1 release. The maintenance mode of Sipwise C5 will disable some background services (for instance: `ngcp-mediator`) during the software upgrade. It thus prevents the system from getting into an inconsistent state while the upgrade is being performed. You can activate maintenance mode by applying a simple configuration change as described later.

- Pull pending configuration (if any):

```
ngcpcfg pull
```

- Enable maintenance mode:

```
ngcpcfg set /etc/ngcp-config/config.yml "general.maintenance=yes"
```

- Apply configuration changes by executing:

```
ngcpcfg apply 'Enabling maintenance mode before the upgrade to mr8.5.9'  
ngcpcfg push all
```

14.5.3 Download new package metadata into the approx cache (on the standby node only)

Warning



Customers with far-sighted software upgrade policies usually have pre-production installations to test the services in their environment before upgrading the production platform. In this case, the approx cache should be updated on both platforms simultaneously to synchronize the package versions between them, hence consider carefully before executing this step.

To download the latest packages metadata into the approx cache, execute the following command on the **standby management** node. This action ensures that all nodes within the platform have identical packages after the software upgrade:

```
ngcp-approx-cache-helper --update --skip-all-repos --extra-ngcp-release mr8.5.9
```

14.6 Upgrading Sipwise C5 CARRIER

Log in to all nodes and execute the checks from Section 14.4 again. This will ensure that nothing was broken since the preparation steps were finished. Also, execute **ngcpcfg show** and **ngcpcfg status** to check the latest configuration changes.

Perform the BFT test.

To upgrade Sipwise C5 CARRIER to mr8.5.9 release, execute the following commands on the **standby management "A" node**:

14.6.1 Upgrading ONLY the first standby management node "A" (web01a/db01a)

Note

Sometimes the DB and MGMT roles are assigned to the same host. This is OK.



Warning

Do NOT execute the software upgrade on web01a and db01a in parallel!

Run the following command node to install the package responsible for upgrading Sipwise C5 to a newer release:

```
ngcp-prepare-upgrade mr8.5.9
```

Note

Don't worry, `ngcp-upgrade-carrier` does not exist, `ngcp-upgrade-pro` is used in Carrier too.

**Warning**

Do not use "`ngcpcfg apply/build`" after executing the steps from the above section, otherwise the changes will be overwritten and you will have to redo these steps. The same applies to similar sections below.

Run the upgrade script on the standby node as *root*:

```
ngcp-upgrade
```

14.6.2 Custom configuration templates

Merge/add the custom configuration templates if needed.

Apply the changes to configuration templates:

```
ngcpcfg apply 'apply customtt/patchtt for new the release mrX.X on xxx01a'
```

Send the new templates to the shared storage and the other nodes

```
ngcpcfg push --nobuild --noapply all
```

**Warning**

Do NOT execute `ngcpcfg push --shared-only` at this stage, as it will affect further upgrades due to noticed outdated local `ngcpcfg` storage. If you did so, run `ngcpcfg push --nobuild --noapply all` once again to pull `ngcpcfg` changes on all the nodes from glusterfs.

14.6.3 Upgrading the standby database node "A" (db*a)

Note

If the DB and MGMT roles are assigned to the same host, then skip this step as you have already upgraded the standby MGMT node "A" above.

Run the following commands to upgrade the standby DB node "A" (select the same release version as above and follow the on-screen recommendations):

```
ngcp-prepare-upgrade mr8.5.9
ngcp-upgrade
```

Note

It is important to upgrade db01a node *before* upgrading any proxy nodes. Otherwise, the "local" MySQL (127.0.0.1:3308) on proxy nodes may become out of sync in case the new release has `_not_replicated.up` DB statements.

14.6.4 Upgrading other standby nodes "A" (lb*a/prx*a)

Run the below commands selecting the same release version and follow the on-screen recommendations:

```
ngcp-prepare-upgrade mr8.5.9
ngcp-upgrade
```

14.6.4.1 Useful options in ngcp-upgrade

The following options in `ngcp-upgrade` can be useful for this phase of upgrades, because it is very likely that the backup was already performed:

- **--skip-db-backup**: This will speed-up the process in cases where it's deemed unnecessary.

See a more detailed description of the options in: [ngcp-upgrade options](#)

14.6.5 Promote ALL standby nodes "A" to active.

**Warning**

Ensure that all standby nodes "A" are: * upgraded to the new release (check `/etc/ngcp_version` or use `ngcp-clish`)
* have been rebooted (run `ngcp-status` on each standby node)

On all "A" nodes run:

```
ngcp-make-active
```

Ensure that the "A" nodes became active, by executing the `'ngcp-status'` and `'ngcp-clish'` commands described above.

Ensure that ALL "B" nodes are standby now!

14.6.6 Upgrading ALL standby nodes "B" (web*b/db*b/lb*b/prx*b)

Run the following commands selecting the same release version and following the on-screen recommendations:

```
ngcp-prepare-upgrade mr8.5.9
ngcp-upgrade
```

Note

You can upgrade all standby "B" nodes simultaneously (including the ones with the mgmt and db roles).

14.6.6.1 Useful options in `ngcp-upgrade`

The following options in `ngcp-upgrade` can be useful for this phase of upgrades:

- `--step-by-step`: confirm before proceeding to next step.
- `--pause-before-step STEP_NAME`: pause execution before step, given by the name of the script (e.g. "backup_mysql_db").

See a more detailed description of the options in: [ngcp-upgrade options](#)

14.7 Upgrading Sipwise C5 PRO

Make sure you are prepared to spend about two hours upgrading the system. Note that a short service downtime is possible during the services switchover to the upgraded node.

Start with the software upgrade on the standby sp1 node. Then, switch the services over to the upgraded node and upgrade the other (now standby) sp2 node, as described in the steps below.

14.7.1 Upgrade the first PRO node

Execute the upgrade script on the **standby** node as *root*:

```
ngcp-prepare-upgrade mr8.5.9
ngcp-upgrade
```

14.7.1.1 Useful options in `ngcp-upgrade`

The following options in `ngcp-upgrade` can be useful for this phase of upgrades:

- `--step-by-step`: confirm before proceeding to next step.
- `--pause-before-step STEP_NAME`: pause execution before step, given by the name of the script (e.g. "backup_mysql_db").

See a more detailed description of the options in: [ngcp-upgrade options](#)

14.7.2 The custom modification handling (optional)

Introduce the custom changes to configuration templates if needed (by adding corresponding patchtt/customtt files). Apply the changes to configuration templates and send them to the shared storage and the other node:

```
ngcpcfg apply 'Added custom changes when the first node was upgraded'
ngcpcfg push --nobuild --noapply
```

14.7.3 Promote the upgraded standby node to active

Execute on the current standby node as `root`:

```
ngcp-make-active
```

14.7.4 Upgrade the second PRO node

Go to the new standby node. Run the upgrade script as `root`:

```
ngcp-prepare-upgrade mr8.5.9
ngcp-upgrade
```

14.7.4.1 Useful options in `ngcp-upgrade`

The following options in `ngcp-upgrade` can be useful for this phase of upgrades, because it is very likely that the backup was already performed in the upgrade of the first node:

- `--skip-db-backup`: This will speed-up the process in cases where it's deemed unnecessary.

See a more detailed description of the options in: [ngcp-upgrade options](#)

14.8 Post-upgrade steps

14.8.1 Disabling maintenance mode

In order to disable the *maintenance mode*, do the following:

- Pull outstanding ngcpcfg changes (if any):

```
ngcpcfg pull
```

- Disable the maintenance mode:

```
ngcpcfg set /etc/ngcp-config/config.yml "general.maintenance=no"
```

- Apply the changes to configuration templates:

```
ngcpcfg apply 'Disable the maintenance mode after the upgrade to mr8.5.9'  
ngcpcfg push all
```

14.8.2 Post-upgrade checks

When everything has finished successfully, check that replication is running. Check `ngcp-status --all`. Finally, do a basic functionality test. Check the web interface, register two test subscribers and perform a test call between them to ensure call routing works.

Note

You can find a backup of some important configuration files of your existing installation under `/ngcp-data/backup/ngcp-mr8.5.9-*` (where `*` is a place holder for a timestamp) in case you need to roll back something at any time. A log file of the upgrade procedure is available at `/ngcp-data/backup/ngcp-mr8.5.9-*/upgrade.log`.

14.9 Applying the Latest Hotfixes

If your current release is already the latest or you prefer to be on the LTS release, we still suggest applying the latest hotfixes and critical bug fixes.

Execute all steps as described in Section 14.4. They include the system checks, customtt/patchtt preparation and others. It is important to execute all the steps from the above chapter.

On a CARRIER it is suggested to promote B-nodes to active and start the update with A-nodes.

14.9.1 Update the approx cache on the standby management node

The main goal of the following command is to download the new packages into the approx cache. So all the nodes in the cluster will get identical packages.

```
ngcp-approx-cache-helper --auto --node localhost
```

14.9.2 Apply hotfixes on the standby management node

```
ngcp-update
```

14.9.3 Recheck or update the custom configuration templates

Merge/add the custom configuration templates if needed.

Apply the changes to configuration templates:

```
ngcpcfg apply 'apply customtt/patchtt after installing the latest packages'
```

Send the new templates to the shared storage and the other nodes.

```
ngcpcfg push --nobuild --noapply all
```

14.9.4 Apply hotfixes on all other standby nodes (CARRIER-only)

```
ngcp-update
```

14.9.5 Promote the standby nodes to active

Execute on the **standby** nodes as *root*:

```
ngcp-make-active
```

Check in a minute that the nodes became active:

```
ngcp-check-active
```

14.9.6 Apply hotfixes on the second node

```
ngcp-update
```

Execute the final checks as described in the **Post-upgrade checks** section.

15 Backup, Recovery and Database Maintenance

15.1 Sipwise C5 Backup

For any service provider it is important to maintain a reliable backup policy as it enables prompt services restoration after any force majeure event. Although the design of Sipwise C5 implies data duplication and high availability of services, we still strongly suggest you to configure a backup procedure. The Sipwise C5 has a built-in solution that can help you back up the most crucial data. Alternatively, it can be integrated with any Debian compatible backup software.

15.1.1 What data to back up

- The database

This is the most important data in the system. All subscriber and billing information, CDRs, user preferences, etc. are stored in the MySQL server. It is strongly recommended to have up-to-date dumps of all the databases on corresponding Sipwise C5 nodes.

- System configuration

The system configuration folder `/etc/ngcp-config/` must be included in the backup as well. It contains the system specific configuration (like SSL keys). Also you might have some local modifications. We suggest backing up the whole `/etc` folder to preserve the *etckeeper* history to be able to answer when and who changed particular configuration files in the past.

- Exported CDRs (optional)

The `/home/jail/home/cdreexport` directory contains the exported CDRs. It depends on your call data retention policy whether or not to remove these files after exporting them to an external system.

15.1.2 The built-in backup solution

The Sipwise C5 comes with an easy-to-use solution that creates everyday backups of the most important data:

- The system configuration files. The whole `/etc` directory is backed up.
- Exported CDRs. The `/home/jail/home/cdreexport` directory with csv files.
- All required databases on corresponding servers.

This functionality is disabled by default and can be enabled and configured in the `backuptools` subsection in the `config.yml` file. Please, refer to the “C.1.3 backup tools” section of the “Sipwise C5 configs overview” chapter for the backup configuration options.

Once you set the required configuration options, apply the changes:

```
ngcpcfg apply 'enable the backup feature'  
ngcpcfg push all
```

Once you activate the feature, Sipwise C5 will create backups in the off-peak time on the standby nodes and put them to the `/ngcp-data/backup/ngcp_backup` directory. You can copy these files to your backup server using `scp` or `ftp`.

Note

make sure that you have enough free disk space to store the backups for the specified number of days.

15.2 Recovery

In the worst case scenario, when the system needs to be recovered from a total loss, you only need 4 steps to get the services back online:

- Install Sipwise C5 as explained in chapter 2.
- Restore the `/etc/ngcp-config/` directory from the backup, overwriting your local files.
- Restore `mysql.encryption.key` in `constants.yml` if new MariaDB instance/binlogs were encrypted (DB is encrypted by default). See the detailed information in [MariaDB data restoration remarks](#).
- Restore the database from the latest MySQL dump.
- Apply the changes to bring the original configuration into effect:

```
ngcpcfg apply 'restored the system from the backup'  
ngcpcfg push all
```

15.3 Reset Database

**Important**

All existing data will be wiped out! Use this script only if you want to clear all previously configured services and start configuration from scratch.

To reset database to its original state you can use a script provided by CE: * Execute `ngcp-reset-db`. It will assign new unique passwords for Sipwise C5 services and reset all services. The script will also create dumps for all Sipwise C5 databases.

15.4 Synchronize database

In case of unresolvable database replication issues or to copy mysql data between a pair of hosts (usually a pair of *sp1* and *sp2* nodes).

There is a script for that: *ngcp-sync-db*.

To synchronize databases you need to run the script on your target host.

- Definitions:
 - *master* - remote/master host (the database is dumped from there)
 - *local* - target/local host (the database is imported onto)
- Usage:



Important

Your existing database on *local* will be completely wiped. The script provides a possibility to backup both *master* and *local* databases during the procedure.

You can run the script with `-h` or `--help` to check its options or use `man ngcp-sync_db`

If you run it without any options it automatically calculates *master* hostname (e.g. if you run it on *sp2* then *sp2==local* and *sp1==master*).

The script also requires mysql credentials and if none is provided it uses the ones from the file `/etc/mysql/sipwise_extra.cnf`. You can specify user and/or password for both *master* and *local*.

Before the actual start it produces a summary with settings used to the procedure and a confirmation prompt to prevent accidental usage. Making use of `--force` option" however suppresses the confirmation prompt. By default no messages are printed on STDOUT (compliant to be integrated into another tools) and with `-v` or `--verbose` options you enable debugging where all the ongoing steps will be printed to STDOUT.

There are 2 modes available for synchronization, *online* and *backup*. By default *online* is used where the procedure does not create any backups and everything goes on the fly. That is useful for large databases where creating backups would require solid amounts of available free disk space. With the *backup* mode *master* db is dumped into a backup file on *local* first (default directory: `/ngcp-data/backup/ngcp-sync-db`) and imported upon the backup completion.

Mysql database connection to the *master* db and the *local* db is the essential part and by default the script tries to establish direct mysql connection however that may not be possible due to the access restrictions. To overcome that you can use `--ssh-tunnel` option and specifying there a local custom free port (e.g. `--ssh-tunnel=33125`) in this case an ssh tunnel will be created to *master* and used to establish the db connection on the *local/host* behalf (NOTE: Public key based ssh negotiation is required for the tunnel as the script does not support ssh credentials for security reasons).

Backups may be a subject to create during synchronizaton for possible rollbacks. To create the *local* db backup you should add `--local-backup`. The *master* db backup is automatically created only using `--sync-mode=backup`. Upon completion

all those created backups are deleted and if you need to keep them please use `--keep-backups` option (NOTE: In case of errors during synchronization and when backups are created they are NOT automatically deleted. Therefore, if the script had failed with an error and afterwards completed successfully you may want to manually remove the remaining backups from `/ngcp-data/backup/ngcp-sync-db`).

- Examples:

Normal online mode synchronization *sp1* → *sp2*.

```
sp2> ngcp-sync-db
```

Normal backup mode synchronization *sp1* → *sp2*.

```
sp2> ngcp-sync-db --sync-mode=backup
```

Forced online mode synchronization *sp1* → *sp2*. USE WITH CARE as there will be no confirmation prompts.

```
sp2> ngcp-sync-db --force
```

Direct mysql db access is not possible. SSH tunnel is initialised to local port 33125 and forwards all connections 127.0.0.1:33125 → *sp1*:3306.

```
sp2> ngcp-sync-db --ssh-tunnel=33125
```

Custom mysql credentials for the *master* db connection (by default: `/etc/mysql/sipwise_extra.cnf`)

```
sp2> ngcp-sync-db --master-user=frank --master-pass=dbconnect
```

Normal online mode synchronization *sp1* → *sp2* with the *local* db backup and retaining the backup. (no *master* backup in this case as it is only available with `--sync-mode=backup`).

```
sp2> ngcp-sync-db --local-backup --keep-backups
```

Normal online mode synchronization *custom-node* → *sp2* with ssh tunnel

```
sp2> ngcp-sync-db --master-host=custom-node --ssh-tunnel=45001
```

Forced synchronization *custom-node* → *sp2* with ssh tunnel, backup sync mode, local backup, custom *master* and *local* db credentials and ports as well as a different backup dir

```
sp2> ngcp-sync-db --force --sync-mode=backup --master-host=custom-node --master-port=3308 <-
--ssh-tunnel=45001 --master-user=frank --master-pass=dbconnect --local-user=john --local <-
-pass=dblocal --local-backup --keep-backups --backup-dir=/home/barry/backups
```

15.5 Accounting Data (CDR) Cleanup

Sipwise C5 offers an easy way to cleanup, backup or archive old accounting data—i.e. CDRs—that is not necessary for further processing any more, or must be deleted according to the law. There are some Sipwise C5 components designed for this purpose and they are commonly called *cleantools*. These are basically configurable scripts that interact with NGCP's *accounting* and *kamailio* databases, or remove exported CDR files in order to clean or archive the unnecessary data.

15.5.1 Cleantools Configuration

The configuration parameters of *cleantools* are located in the main Sipwise C5 configuration file: `/etc/ngcp-config/config.yml`. Please refer to the `config.yml` file description: [Cleantools Configuration Data](#) for configuration parameter details.

In case the system administrator needs to modify some configuration value, the new configuration must be activated in the usual way, by running the following commands:

```
> ngcpcfg apply 'Modified cleantools config'
> ngcpcfg push all
```

As a result new configuration files will be generated for the accounting database and the exported CDR cleanup tools. Please read detailed description of those tools in subsequent sections of the handbook.

The Sipwise C5 system administrator can also select the time when cleanup scripts are run, by modifying the schedule here: `/etc/cron.d/cleanup-tools`

15.5.2 Accounting Database Cleanup

The script responsible for cleaning up the database is: `ngcp-cleanup-acc`

The configuration file used by the script is: `/etc/ngcp-cleanup-tools/acc-cleanup.conf`

An extract from a sample configuration file is provided here:

```
#####
```



```
batch = 10000
archive-target = /ngcp-data/backup/cdr
compress = gzip

username = dbcleaner
password = rcKamRdHhx7saYRbkJfP
host = localhost

connect accounting
time-column = from_unixtime(start_time)
backup-months = 2
backup-retro = 2
backup cdr

connect accounting
archive-months = 2
archive cdr

connect kamailio
time-column = time
cleanup-days = 90
cleanup acc

# Clean up after ngcp-mediator by deleting old leftover acc entries and
# deleting old entries out of acc_trash and acc_backup
connect kamailio
time-column = time
cleanup-days = 30
cleanup acc_trash
cleanup acc_backup
```

The configuration file itself contains a detailed description of how database cleanup script works. It consists of a series of statements, one per line, which are going to be executed in sequence. A statement can either just set a variable to some value, or perform an action.

There are 3 types of actions the database cleanup script can take:

- backup CDRs
- archive CDRs
- cleanup CDRs

These actions are discussed in following sections.

A generic action is connecting to the proper database: `connect <database name>`

15.5.2.1 Backup CDRs

The database cleanup tool can create *monthly backups* of CDRs in the `accounting` database and store those data records in separate tables named: `cdr_YYYYMM`. The instruction in the configuration file looks like: `backup <table name>`, by default and typically it is: `backup cdr`

Configuration values that govern the backup procedure are:

- `time-column`: Which column in `cdr` table shows the month which a CDR belongs to.
- `batch`: How many records to process within a single SQL statement. If unset, less than or equals 0, all of them are processed at once.
- `backup-months`: How many months worth of records to keep in the `cdr` table—where current CDRs are stored—and not move into the monthly backup tables.



Important

Months are always processed as a whole, thus the value specifies how many months to keep AT MOST. In other words, if the script is started on December 15th and this value is set to "2", then all of December and November is kept, and all of October will be backed up.

- `backup-retro`: How many months to process for backups, going backwards in time. Using the example above, with this value set to "3", the months October, September and August would be backed up, while any older records would be left untouched.

15.5.2.2 Archive CDRs

The database cleanup tool can archive (dump) old monthly backup tables. The statement used for this purpose is: `archive <table name>`, by default and typically it is: `archive cdr`

This creates an SQL dump out of too old tables created by the `backup` statement and drop them afterwards from database. Archiving uses the following configuration values:

- `archive-months`: Uses the same logic as the `backup-months` variable above. If set to "12" and the script was started on December 15th, it will start archiving with the December table of the previous year.



Important

Note that the sum of `backup-retro` + `backup-months` values cannot be larger than `archive-months` value for the same table. Otherwise you end up creating empty monthly backup tables, only to dump and delete them right afterwards.

- `archive-target`: Target directory for writing the SQL dump files into. If explicitly specified as `"/dev/null"`, then no actual archiving will be performed, but instead the tables will only be dropped from database.
- `compress`: If set to "gzip", then gzip the dump files after creation. If unset, do not compress.
- `host`, `username` and `password`: As dumping is performed by an external command, those variables are reused from the `connect` statement.

15.5.2.3 Cleanup CDRs

The database cleanup tool may do database table cleanup without performing backup. In order to do that, the statement: `cleanup <table name>` is used. Typically this has to be done in `kamailio` database, examples:

- `cleanup acc`
- `cleanup acc_trash`
- `cleanup acc_backup`

Basically the `cleanup` statement works just like the `backup` statement, but doesn't actually backup anything, but rather just deletes old records. Configuration values used by the procedure:

- `time-column`: Gives the database column name that shows the time of CDR creation.
- `batch`: The same as with `backup` statement.
- `cleanup-days`: Any record older than this many days will be deleted.

15.5.3 Exported CDR Cleanup

The script responsible for cleaning up exported CDR files is: `ngcp-cleanup-cdr-files`

The configuration file used by exported CDR cleanup script is: `/etc/ngcp-cleanup-tools/cdr-files-cleanup.yml`

A sample configuration file is provided here:

```
enable: no
max_age_days: 30
paths:
-
  path: /home/jail/home/*/20[0-9][0-9][0-9][0-9]/[0-9][0-9]
  wildcard: yes
  remove_empty_directories: yes
  max_age_days: ~
-
  path: /home/jail/home/cdrexpport/resellers/*/20[0-9][0-9][0-9][0-9]/[0-9][0-9]
  wildcard: yes
  remove_empty_directories: yes
  max_age_days: ~
-
  path: /home/jail/home/cdrexpport/system/20[0-9][0-9][0-9][0-9]/[0-9][0-9]
  wildcard: yes
  remove_empty_directories: yes
  max_age_days: ~
```

The exported CDR cleanup tool simply deletes CDR files in the directories provided in the configuration file, if those have already expired.

Configuration values that define the files to be deleted:

- `enable`: Enable (`yes`) or disable (`no`) exported CDR cleanup.
- `max_age_days`: Gives the expiration time of the exported CDR files in days. There is a general value which may be overridden by a local value provided at a specific path. The local value is valid for the particular path only.
- `paths`: an array of path definitions
 - `path`: a path where CDR files are to be found and deleted; this may contain wildcard characters
 - `wildcard`: Enable (`yes`) or disable (`no`) using wildcards in the `path`
 - `remove_empty_directories`: Enable (`yes`) or disable (`no`) removing empty directories if those are found in the given `path`
 - `max_age_days`: the local expiration time value for files in the particular `path`

16 Platform Security, Performance and Troubleshooting

Once Sipwise C5 is in production, security and maintenance becomes really important. In this chapter, we'll go through a set of best practices for any production system.

16.1 Sipwise SSH access to Sipwise C5

The Sipwise C5 provides SSH access to the system for Sipwise operational team for debugging and final tuning. Operational team uses user *sipwise* which can be logged in through SSH key only (password access is disabled) from dedicated access server *jump.sipwise.com* only.

To completely remove Sipwise access to your system, please execute as user root:

```
root@myserver:~# ngcp-support-access --disable && apt-get install ngcp-support-noaccess
```

Note

you have to execute the command above on each node of your Sipwise C5 system!



Warning

please ensure that the script complete successfully:

```
* Support access successfully disabled.
```

If you need to restore Sipwise access to the system, please execute as user root:

```
root@myserver:~# apt-get install ngcp-support-access && ngcp-support-access --enable
```



Warning

please ensure that the script complete successfully:

```
* Support access successfully enabled.
```

16.2 Firewalling

16.2.1 Firewall framework

The Sipwise C5 runs a wide range of services. In order to secure the platform while allowing access to Sipwise C5, Sipwise C5 configuration framework provides a set of predefined network zones. Services are aggregated into appropriate zones by default. Zones are assigned to network interfaces (and VLANs if applicable) in `/etc/ngcp-config/network.yml`.

Caution



Though the default firewall setup provided by Sipwise C5 configuration framework provides a safe setup for Sipwise C5, security audits of the platform performed by qualified engineers before commissioning the platform into service are strongly recommended. Customization of the setup requires in-depth knowledge of firewalling principles in general and the *netfilter* facility in particular.

Table 21: Sipwise C5 network zones

Zone name	Description
ha_int	Internal HA (High Availability) communication interface between the services
mon_ext	Interface to connect external monitoring appliances (SNMP)
rtp_ext	Interface for external RTP media relay between Sipwise C5 and endpoints (e.g. user agents, peers)
sip_ext	Interface for external SIP signalling between Sipwise C5 and endpoints (e.g. user agents, peers)
sip_int	Interface for internal signalling, e.g. between load-balancers, proxies and applications servers
ssh_ext	Interface providing external access to Sipwise C5 command line interface
ssh_int	Interface providing internal access to Sipwise C5 command line interface (necessary for ngcp-installer)
web_ext	Interface providing access to the customers' self-care Web panel
web_int	Interface for access to the administrative Web panel, its REST APIs and internal API communications

Note

Additional custom zones may be configured, but will not be automatically integrated into the firewall configuration.

To facilitate firewall functionality, Sipwise C5 uses the Kernel's *netfilter* facility and *iptables-persistent* as an interface to *netfilter*. *Netfilter* is using *tables* and within that *chains* to store rules in this hierarchy: *table* → *chain* → *rule*. Default firewall setups of Sipwise C5 do not use netfilter tables *nat* and *raw*, but only default table *filter*.

Note

Custom *nat* rules for IPv4 and IPv6 may be added in file `/etc/ngcp-config/config.yml` in sections `security→firewall→nat_rules4` and `security→firewall→nat_rules6`.

Each *chain* deploys a *default policy* handling packets which did not trigger and rule in a particular *chain*.

Table 22: Sipwise C5 *netfilter* default policies

Chain	Default policy	Description
INPUT	DROP	Handling all packets directly destined for a Sipwise C5 node (only packets matching a rule are allowed)
FORWARD	DROP	Handling all packets received by a Sipwise C5 node and destined for another, non-local IP destination (no default rules added)
OUTPUT	ACCEPT	Handling all packets originating on a Sipwise C5 node (no default rules added)
rtpengine	N/A	Container for rtpengine rule to allow the rule to persist even when the Kernel module is unloaded (e.g. during upgrades)

The default firewall setup provided by Sipwise C5:

- adds rules to INPUT to secure access to platform and services
- blocks all traffic from and to FORWARD
- allows all OUTPUT traffic

16.2.2 Sipwise C5 firewall configuration

The Sipwise C5 comes with a preconfigured set of firewall rules, which can be enabled and configured in `/etc/ngcp-config/config.yml` in section `security→firewall`. Refer to Section [B.1.34](#) for available configuration options.

Firewall configuration is applied by running `ngcpcfg apply`. However, this will not activate new rules automatically to avoid inadvertent self-lockout. To finally activate new firewall rules run `iptables-apply`. This will prompt for another system logon to verify access remains available. If the prompt is not confirmed, firewall rules will automatically be reverted to the previous state re-enabling access to the command line.

**Important**

`iptables-apply` needs to be enforced on each active and standby C5 node providing the *mgmt*, *lb*, or *rtp* roles (Please, refer to Section [12.1.1](#) for further details). Additionally, any changes made into firewall rules will require to execute this command again on the corresponding nodes.

Caution

The Sipwise C5 firewall subsystem by default is disabled in `/etc/ngcp-config/config.yml` key `security.firewall.enable: no`. This is to avoid blocking any traffic inadvertently during installation. After the firewall subsystem has been configured appropriately, it needs to be enabled by setting `security.firewall.enable: yes` in `/etc/ngcp-config/config.yml`.

16.2.3 IPv4 System rules

The following set of rules is added by the system upon activation of the firewall subsystem. Individual system rules are configured in `/etc/ngcp-config/templates/etc/iptables/rules.v4.tt2` and `/etc/ngcp-config/templates/etc/iptables/rules.v6.tt2`

Table 23: Firewall system rules

Zone	Chain	Target	Rule	Description
all	INPUT	rtpengine	<code>-p udp -j rtpengine</code>	Redirects all incoming UDP packets to chain <code>rtpengine</code> (putting RTPENGINE rule into a dedicated chain allows for the rule to persist even when the Kernel module gets unloaded, e.g. during upgrades)
all	rtpengine	RTPENGINE	<code>-p udp -j RTPENGINE --id 0</code>	Feeds all RTP packets to RTPENGINE Kernel module
n/a	INPUT	ACCEPT	<code>-i lo -j ACCEPT</code>	Accept all packets received by local loopback interface
all	INPUT	ACCEPT	<code>-m state --state RELATED,ESTABLISHED -j ACCEPT</code>	Accept all incoming packets tied to <i>related</i> or <i>established</i> connections
all	INPUT (IPv4)	ACCEPT	<code>-p icmp -m icmp --icmp-type 8 -j ACCEPT</code>	Accept all ICMP <i>echo</i> messages
all	INPUT (IPv4)	ACCEPT	<code>-p icmp -m icmp --icmp-type 0 -j ACCEPT</code>	Accept all ICMP <i>echo reply</i> messages
all	INPUT (IPv6)	ACCEPT	<code>-A INPUT -p ipv6-icmp -j ACCEPT</code>	Accept all ICMPv6 messages
all	INPUT	cluster	<code>-j cluster</code>	Divert all incoming packets to the <i>cluster</i> chain
all	cluster	ACCEPT	<code>-s <node_ip> -j ACCEPT</code>	Set of rules white-listing all IP-addresses owned by Sipwise C5 platform for incoming traffic

Table 23: (continued)

Zone	Chain	Target	Rule	Description
api_int	INPUT	ACCEPT	<pre>-p tcp --dport <ossbss.port> -j ACCEPT</pre>	Set of rules for all <i>api_int</i> interfaces accepting all incoming packets for API port defined in <i>/etc/ngcp-config/config.yml</i> with key <i>ossbss.port</i>
mon_ext	INPUT	ACCEPT	<pre>+p udp -s <snmpclient_ip> --dport 161 -j ACCEPT</pre>	Set of rules for all <i>mon_ext</i> interfaces based on a list of IPs for all SNMP communities configured in <i>snmpd.communities</i>
rtp_ext	INPUT	ACCEPT/ <i>name</i>	<pre>-p udp --dport <rtpproxy.minport>:'<rtpproxy.maxport>' -j ACCEPT/<i>name</i></pre>	Set of rules for all <i>rtp_ext</i> interfaces accepting all incoming packets for RTP port range defined in <i>/etc/ngcp-config/config.yml</i> with keys <i>rtpproxy.minport</i> and <i>rtpproxy.maxport</i> (see note below for custom options)
sip_ext	INPUT	ACCEPT	<pre>-p udp --dport <kamailio.lb.port> -j ACCEPT</pre>	Set of rules for all <i>sip_ext</i> interfaces accepting all packets on the loda balancer's SIP signalling port defined in <i>/etc/ngcp-config/config.yml</i> with key <i>kamailio.lb.port</i> (UDP)
sip_ext	INPUT	ACCEPT	<pre>-p tcp --dport <kamailio.lb.port> -j ACCEPT</pre>	Set of rules for all <i>sip_ext</i> interfaces accepting all packets on the loda balancer's SIP signalling port defined in <i>/etc/ngcp-config/config.yml</i> with key <i>kamailio.lb.port</i> (TCP)
sip_ext	INPUT	ACCEPT	<pre>-p tcp --dport <kamailio.lb.tls.port> -j ACCEPT</pre>	Set of rules for all <i>sip_ext</i> interfaces accepting all packets on the loda balancer's SIP signalling port defined in <i>/etc/ngcp-config/config.yml</i> with key <i>kamailio.lb.tls.port</i> (TCP/TLS)
sip_ext	INPUT	ACCEPT	<pre>-p tcp --dport 5222 -j ACCEPT</pre>	Set of rules for all <i>sip_ext</i> interfaces accepting all packets on TCP port 5222 (XMPP client)
sip_ext	INPUT	ACCEPT	<pre>-p tcp --dport 5269 -j ACCEPT</pre>	Set of rules for all <i>sip_ext</i> interfaces accepting all packets on TCP port 5269 (XMPP server)

Table 23: (continued)

Zone	Chain	Target	Rule	Description
sip_ext	INPUT	ACCEPT	<code>-p tcp --dport <pushd.port> -j ACCEPT</code>	Set of rules for all <i>sip_ext</i> interfaces accepting all packets incoming for the <i>pushd</i> server port configured in <i>/etc/ngcp-config/config.yml</i> with key <i>pushd.port</i>
ssh_ext	INPUT	ACCEPT	<code>-A INPUT -i <ssh_ext_interface> -p tcp -s <sshd.permit_support_from> --dport sshd.port -j ACCEPT</code>	List of rules to accept incoming packets for SSH on all <i>ssh_ext</i> interfaces from hosts configured in <i>/etc/ngcp-config/config.yml</i> with key <i>sshd.permit_support_from</i>
web_ext	INPUT	ACCEPT	<code>-p tcp --dport <www_admin.http_csc.port> -j ACCEPT</code>	List of rules to accept incoming packets for the <i>Customer Self Care</i> interface defined in <i>/etc/ngcp-config/config.yml</i> with key <i>www_admin.http_csc.port</i> on all <i>web_ext</i> interfaces
web_int	INPUT	ACCEPT	<code>-p tcp --dport <www_admin.http_admin.port> -j ACCEPT</code>	List of rules to accept incoming packets for the <i>Admin Panel</i> interface defined in <i>/etc/ngcp-config/config.yml</i> with key <i>www_admin.http_admin.port</i> on all <i>web_int</i> interfaces

Caution

To function correctly, the *rtengine* requires an additional *iptables* rule installed. This rule (with a target of `RTPENGINE`) is automatically installed and removed when the *rtengine* starts and stops, so normally you don't need to worry about it. However, any 3rd party firewall solution can potentially flush out all existing *iptables* rules before installing its own, which would leave the system without the required `RTPENGINE` rule and this would lead to decreased performance. It is imperative that any 3rd party firewall solution either leaves this rule untouched, or installs it back into place after flushing all rules out. The complete parameters to install this rule (which needs to go into the `INPUT` chain of the `filter` table) are: `-p udp -j RTPENGINE --id 0`

Note

Some of the parameters used to populate the firewall rules automatically may contain hostnames instead of IP addresses. Since firewall rules need to be configured based on IP addresses by design, Sipwise C5 configuration framework will lookup such hostnames during *ngcpctl apply* and expand them to the IP addresses as returned by *gethostbyname*. If DNS resolving changes for such hostnames due to changes to DNS the rules will not update automatically. Another run of *ngcpctl apply* will be needed to reperform the lookup and update the rules to reflect changes in DNS. If this step is omitted, clients may be locked out of the system.

Note

By default, the rules for the *rtp_ext* zone are created with a target of `ACCEPT`. It is optionally possible to create these rules with another *iptables* chain as target, and instruct the RTP proxy to dynamically manage individual rules for each running call in this chain. If this is enabled, the chain with the name given in the `/etc/ngcp-config/config.yml` key `rtpproxy→firewall_iptables_chain` will be created as empty, leaving the effective target for UDP packets within the RTP port range as the table's default policy (normally `DROP`). The RTP proxy will then dynamically create one `ACCEPT` rule for each open RTP media port in the given chain when a call starts, and delete it when the call is finished. It should be noted that dynamically creating and deleting *iptables* rules can incur a significant performance overhead, especially in scenarios with high call volumes, and it is therefore not recommended to enable this feature in such cases.

16.2.4 Custom rules

The Sipwise C5 configuration framework makes it possible to add custom rules to the firewall setup in `/etc/ngcp-config/config.yml`. The custom rules are added after the system rules. Hence, they apply for packets not matched by the systems rules only.

Example custom rule to whitelist all IPv4 traffic from network interface `eth1.301` effectively making VLAN 301 a trusted network:

```
rules4:
  - '-A INPUT -i eth1.301 -j ACCEPT'
```

Example custom rule to accept incoming traffic from monitoring station `203.0.113.93` for an optionally installed `check_mk` agent:

```
rules4:
  - '-A INPUT -p tcp -s 203.0.113.93 --dport 6556 -j ACCEPT'
```

To add hosts or networks to the SSH whitelist they can be either added to key `sshd.permit_support_from` in `/etc/ngcp-config/config.yml` or a custom rule may be used:

```
rules4:
  - '-A INPUT -s 198.51.100.0/24 --dport 22 -j ACCEPT'
  - '-A INPUT -s 203.0.113.93 --dport 22 -j ACCEPT'
```

Note

In custom rules keys from `/etc/ngcp-config/config.yml` cannot be referenced. Thus, the values need to be manually looked up, hard coded, and kept in sync manually. This is by design of YAML.

16.2.5 Example firewall configuration section

An example for Sipwise C5 firewall configuration in `/etc/ngcp-config/config.yml` enabling both the firewall subsystem and the logging facility may look like:

```
security:
  firewall:
    enable: yes
    logging:
      enable: yes
      file: '/var/log/firewall.log'
      tag: 'NGCPFW'
  policies:
    input: 'DROP'
    forward: 'DROP'
    output: 'ACCEPT'
  rules4:
    - '-A INPUT -i eth0 -j ACCEPT'
```

16.3 Password management

The Sipwise C5 comes with some default passwords the user should change during the deployment of the system. They have been explained in the previous chapters of this handbook.

**Important**

Many Sipwise C5 services use MySQL backend. Users and passwords for these services are created during the installation. These passwords are unique for each installation, and the connections are restricted to localhost. You should not change these users and passwords.

16.3.1 The "root" account

The Sipwise C5's super-user account comes with a preconfigured password. It is imperative that this password is changed by the operator immediately after Sipwise C5 is shipped and before it is connected to any potentially unsecure public or private network using a secure password in compliance with existing password policies of the operator. The "root" password must not be shared outside of the operator's organization including Sipwise engineers. The "root" password must not be shared in any publicly accessible communications including e-mail or ticketing systems.

To change the root password log into the freshly deployed system as "root" using the preconfigured password and execute:

```
root@myserver:~# passwd
```

Then follow the prompts to change the password.

16.3.2 The "administrator" account

The Sipwise C5 Web-interface comes with a preconfigured "administrator" account deployed with a default password. This account can be considered Sipwise C5 application super-user and has far-reaching access to application specific settings via the Web-interface. It is imperative that the password for this account is changed by the operator immediately after Sipwise C5 is shipped and before it is connected to any potentially unsecure public or private network using a secure password in compliance with existing password policies of the operator. The "administrator" password must not be shared outside of the operator's organization including Sipwise engineers. The "administrator" password must not be shared in any publicly accessible communications including e-mail or ticketing systems.

The password for the "administrator" account can be changed via the Web-interface.

16.3.3 The "cdreexport" account

The login for the system account *cdreexport* is disabled by default. Although this is a jailed account, it has access to sensitive information, namely the Call Detail Records of all calls. SSH keys should be used to login this user, or alternatively a really strong password should be used when setting the password via *passwd cdreexport*.

16.3.4 The MySQL "root" user

The *root* user in MySQL has no default password. A password should be set using the *mysqladmin password* command.

16.3.5 The "ngcpssoap" account

Generate new password for user *ngcpssoap* to access the provisioning interfaces, see the details in Section 10.

16.4 Remote *root* logins via SSH

To mitigate possible system intrusions from the outside, it is commonly held best practise to disable remote *root* (administrator) logins. With remote root logins disabled, it's still possible to log into the system via SSH to a regular, non-privileged user account, and then use *sudo* or *su* to elevate account privileges to *root* administrator level.



Warning

For system setup purposes, the default setting on the Sipwise C5 is to permit remote *root* logins via SSH. It is strongly recommended to change this default setting as soon as possible.

Once you've created a user account for yourself that can be used to gain *root* privileges, remote *root* logins can be disabled via the config switch `sshd→permit_root_login` in `/etc/ngcp-config/config.yml`.

```
sshd:  
  permit_root_login: yes
```

Valid options are:

- *yes* - permit remote root logins via SSH. Not recommended.
- *no* - prohibit all remote root logins via SSH.
- *prohibit-password* - permit remote root logins, except when password authentication is used. This is a good setting if you still wish to access the *root* account directly using public-key authentication, but also want to prohibit remote brute-force attacks against the *root* account password.
- *forced-commands-only* - identical to *prohibit-password* but with the additional restriction that only SSH config sections that have a forced command (via `command=` or `ForceCommand`) are permitted to log in. For advanced users.

If either *no* or *forced-commands-only* is chosen, the Sipwise C5 will generate special SSH config sections that still allow root logins (using *prohibit-password*) from IP addresses that are internal to the Sipwise C5. This is necessary to ensure that the scripts handling the Sipwise C5 config framework continue to function and does not compromise security.

16.5 *sudo-io*: logging input/output of commands run through *sudo*

It is possible to enable logging for the input and output of commands run through *sudo*, along other meta-information like timing, to be able to reproduce sessions.

The logs are saved in directories with a special structure, the numbers are for a so-called "session" or sequence:

```
$BASE_DIR/$USERNAME/00/00/00
```

For example:

```
/var/log/sudo-io/root/00/00/00
```

and within them, several files for tty input and output, stdin/stdout/stderr, and other ancillary files.

New session use `00/00/01`, `00/00/02` and so on.

This is disabled by default, but can be configured in `/etc/ngcp-config/config.yml` with the following options:

```
sudo:
  logging:
    enable: no
    exclude_users: []
    max_sessions: 0
```

Valid options are:

- *enable*: *no* (default) or *yes*; to use the feature or not
- *exclude_users*: list of users whose commands are excluded from logging
- *max_sessions*: 0 by default, which means unlimited. If set to a positive integer, the sequence returns to 0 after reaching it, and starts to overwrite the files in the subdir *00/00/00* instead of increasing indefinitely.

**Warning**

This sudo plugin saves all input and output including passwords typed in shell prompts (even when they are not echoed to the screen), and this is unencrypted, so please consider the security implications.

**Warning**

Even if in some versions the compression of these files is enabled (releases mr9.5 and after), some commands can use huge amounts of data and fill-up the available disk space very quickly, and full disk will cause serious problems (failures in services, or even preventing external access to the system to fix the problems). Please consider setting up monitoring of free space, or mitigating measures like setting a small amount of sessions saved, taking data out the system often for preservation and deleting sessions from previous days, etc.

**Warning**

Additionally, this has a performance impact (both CPU and I/O) on every command run with sudo that triggers logging, negligible for most commands but significant when the input or output is large.

16.6 SSL certificates

The Sipwise C5 provides default, self-signed SSL certificates for SSL connections. These certificates are common for every installation. Before going to production state, the system administrator should provide SSL certificates for the web services. These certificates can either be shared by all web interfaces (*provisioning*, *administrator interface* and *customer self care interface*), or separate ones for each them can be used.

- Generate the certificates. The *customer self care interface* certificate should be signed by a certification authority to avoid browser warnings.
- Upload the certificates to the system

- Set the path to the new certificates in `/etc/ngcp-config/config.yml`:
 - `ossbss→apache→autoprov→sslcertfile` and `ossbss→apache→autoprov→sslcertkeyfile` for the *provisioning interface*.
 - `ossbss→apache→restapi→sslcertfile` and `ossbss→apache→restapi→sslcertkeyfile` for the *REST interface*.
 - `www_admin→http_admin→sslcertfile` and `www_admin→http_admin→sslcertkeyfile` for the *admin interface*.
 - `www_admin→http_csc→sslcertfile` and `www_admin→http_csc→sslcertkeyfile` for the *customer self care interface*.
- Apply the configuration changes with `ngcpcfg apply 'added web ssl certs'`.

The Sipwise C5 also provides the self-signed SSL certificates for SIP over TLS services. The system administrator should replace them with certificates signed by a trusted certificate authority if he is going to enable it for the production usage (`kamailio→lb→tls→enable` (disabled by default)).

- Generate the certificates.
- Upload the certificates to the system
- Set the path to the new certificates in `/etc/ngcp-config/config.yml`:
 - `kamailio→lb→tls→sslcertfile` and `kamailio→lb→tls→sslcertkeyfile`.
- Apply the configuration changes with `ngcpcfg apply 'added kamailio certs'`.

16.7 Securing your Sipwise C5 against SIP attacks

The Sipwise C5 allows you to protect your VoIP system against SIP attacks, in particular **Denial of Service** and **brute-force attacks**. Let's go through each of those attacks and let's see how to configure your system in order to face such situations and react against them.

16.7.1 Denial of Service

As soon as you have packets arriving on your Sipwise C5 server, it will require a bit of time of your CPU. Denial of Service attacks are aimed to break down your system by sending floods of SIP messages in a very short period of time and keep your system busy to handle such huge amount of requests. Sipwise C5 allows you to block such kind of attacks quite easily, by configuring the following section in your `/etc/ngcp-config/config.yml`:

```
kamailio:
  lb:
    security:
      dos_ban_enable: yes
      dos_ban_time: 3600
      dos_reqs_density_per_unit: 50
      dos_sampling_time_unit: 2
      dos_whitelisted_ips: []
      dos_whitelisted_subnets: []
```

Basically, as soon as Sipwise C5 receives more than 50 messages from the same IP in a time window of 2 seconds, that IP will be blocked for 3600 sec, and you will see in the `kamailio-lb.log` a line saying:

```
Nov 9 00:11:53 sp1 lb[41958]: WARNING: <script>: IP '1.2.3.4' is blocked and banned - R=< ←  
null> ID=304153-3624477113-19168@tedadg.testlab.local
```

The banned IP will be stored in kamailio memory, you can check the list via web interface or via the following command:

```
# ngcp-kamctl lb fifo htable.dump ipban
```



Important

On CARRIER systems, this command must be executed on the **active** load balancer node.

Excluding SIP endpoints from banning

There may be some SIP endpoints that send a huge traffic towards Sipwise C5 from a specific IP address. A typical example is a *SIP Peering Server*.



Caution

Sipwise C5 supports handling such situations by excluding all defined *SIP Peering Servers* from DoS protection mechanism.

The Sipwise C5 platform administrator may also add whitelisted IP addresses manually in `/etc/ngcp-config/config.yml` at `kamailio.lb.security.dos_whitelisted_ips` and `kamailio.lb.security.dos_whitelisted_subnets` parameters.

16.7.2 Bruteforcing SIP credentials

This is a very common attack that can be checked via the `/var/log/ngcp/kamailio-proxy.log` file. There will be INVITE/REGISTER messages coming in with strange usernames. Attackers are trying to spoof/guess subscriber's credentials, which allow them to call out. The very first protection against these attacks is: **ALWAYS USE STRONG PASSWORD**. Nevertheless, Sipwise C5 allows you to detect and block such attacks quite easily by configuring the following parameters in `/etc/ngcp-config/config.yml` file:

```
kamailio:  
  lb:  
    security:
```

```
failed_auth_attempts: 3
failed_auth_ban_enable: yes
failed_auth_ban_time: 3600
```

It may be required to increase the number of failed attempts by adjusting the ban time (e.g. some users can be banned accidentally because they are not writing the right password). If a user tries to authenticate an INVITE/REGISTER (or more in general, any request containing an *Authorization* or *Proxy-Authorization* SIP header) and if it fails more than 3 times, the *user@domain* (not the IP as for Denial of Service attack) will be blocked for 3600 seconds (see *failed_auth_ban_time* on */etc/ngcp-config/config.yml*). In this case, you will see the following lines in */var/log/ngcp/kamailio-lb.log* file:

```
Nov 9 13:31:56 sp1 lb[41952]: WARNING: <script>: Consecutive Authentication Failure for '↔
sipvicous@mydomain.com' UA='sipvicous-client' IP='1.2.3.4' - R=<null> ID ↔
=313793-3624525116-589163@testlab.local
```

Both the banned IPs and banned users will be shown in the Admin web interface by accessing the *Settings* → *Security Bans* menu. To retrieve the same information from *Kamailio* memory, use the following command:

```
# ngcp-kamctl lb fifo htable.dump auth
```



Important

On CARRIER systems, this command must be executed on the **active** load balancer node.

16.8 Topology Hiding

16.8.1 Introduction to Topology Hiding on NGCP

The term "topology hiding" in SIP is used to describe the measures taken by typically an SBC (Session Border Controller) to hide detailed information of the internal network at the border of which it is located. Pieces of information such as IP addresses and port numbers used by SIP endpoints and intermediaries within the network are considered sensitive, as these can give some hints to potential attackers about the topology of the network.

In a typical SIP session the mandatory headers may carry that sensitive information, for example: *Contact*, *Via*, *Record-Route*, *To*, *From*, *Call-ID*. An SBC applying topology hiding will mangle the content of those headers.

16.8.2 Topology Masking Mechanism

Concealment of sensitive information using this mechanism is achieved through encoding the original content of selected SIP headers. Then Sipwise C5 will create a new SIP URI using a preselected IP address and the encoded content as URI parameter, finally re-assembling the SIP header.

Examples for encoded SIP headers:

```
Record-Route: <sip:127.0.0.8;line=sr-NvaAlWtecghucEhu6WtAcu...>
Contact: <sip:127.0.0.8;line=sr-NvaAli-1VeL.kRxLcbN86W...>
```

The *load-balancer* element of Sipwise C5 has an SBC role, from the SIP peers point of view. The *LB* offers topology masking function that can be simply activated through a configuration change. By default the function is disabled.

16.8.2.1 Configuration of Topology Masking

Activating topology masking function is possible through the modification of the following configuration parameters in `/etc/ngcp-conf` file (shown below with default values of parameters):

```
kamailio:
  lb:
    security:
      topoh:
        enable: no
        mask_callid: no
        mask_ip: 127.0.0.8
```

Meaning of the configuration parameters:

- `enable`: if set to `yes`, the topology mask will be activated
- `mask_callid`: if set to `yes`, the SIP Call-ID header will also be encoded
- `mask_ip`: an IP address that will be used to create valid SIP URIs, after encoding the real/original header content.

Tip

Any valid, preferably private network address can be used. The suggestion is however to use an address that is not used by any other SIP endpoint or intermediary element in the network.

16.8.2.2 Considerations for Topology Masking

Although masking sensitive information about a VoIP provider's network is desired, there are some potential side effects caused by topology masking.

The most common example is the consequence that **SIP message size may grow** when applying topology masking. The fact that SIP messages become larger may even prevent Sipwise C5 from communicating successfully with another SIP entity (a peer SBC, for example). This can be expected under following circumstances:

- SIP transport protocol is UDP

- SIP messages have more *Via and Record-Route* headers
- IP packets of SIP messages without the topology masking feature already have a size close to the MTU

In such a case the IP packets carrying SIP messages with encoded headers will have a size exceeding the MTU, that will cause loss of data in some networks.

The recommended solution in such a case is to use TCP transport for SIP messages.

16.8.3 Topology Hiding Mechanism

This mechanism achieves topology hiding by stripping the SIP routing headers that show topology details and storing those data in the associative data structure (hash) in the Redis DB so that it can look it up when a reply or in-dialog SIP message comes in. From the signaling perspective it simulates a SBC (Session Border Controller) on the LB.

16.8.3.1 Considerations for Topology Hiding

This mechanism offers some benefits over the older topology masking approach:

- It enables the Sipwise C5 to interconnect with SIP endpoints that are not capable of operating through a SIP proxy.
- The message size is decreased because of stripping the SIP Record-Route, Route and Via header fields.
- It solves the interoperability issues with SIP ALG in some cases.
- It retains also the lightweight nature and the efficient operation.

The module uses the auto-expiration of the Redis keys so it can cause temporary spikes in the memory usage and redis keys count until produced data is cleaned up by redis.

16.8.3.2 Configuration of Topology Hiding

Activation of the topology hiding function is done through the modification of the following configuration parameters in `/etc/ngcp-conf` file (shown below with default values of parameters):

```
topos:
  enable: no
  redis_db: 24
```

In order to activate the function, you should set `enable: 'yes'` in `/etc/ngcp-config/config.yml` and leave the Redis DB number unchanged, then execute `ngcpcfg apply "activated topos"`.

16.9 System Requirements and Performance

The Sipwise C5 is a very flexible system, capable of serving from hundreds to several tens of thousands of subscribers in a single node. The system comes with a default configuration, capable of serving up to 50.000 subscribers in a *normal* environment. But there is no such thing as a *normal* environment. And Sipwise C5 has sometimes to be tuned for special environments, special hardware requirements or just growing traffic.

Note

If you have performance issues with regards to disk I/O please consider enabling the *noatime* mount option for the root filesystem. Sipwise recommends the usage of *noatime*, though remove it if you use software which conflicts with its presence.

In this section some parameters will be explained to allow Sipwise C5 administrator tune the system requirements for optimum performance.

Table 24: Requirement_options

Option	Default value	Requirement impact
cleanuptools→binlog_days	15	Heavy impact on the harddisk storage needed for mysql logs. It can help to restore the database from backups or restore broken replication.
database→bufferpoolsize	1/2 * Total system RAM	The installer will calculate the total system RAM and dedicate 50% to the mysql innodb buffer. This value won't be changed in case the system RAM changes so it's up to the administrator to adjust it. For test systems or low RAM systems, lowering this setting is one of the most effective ways of releasing RAM. The administrator can check the innodb buffer hit rate on production systems; a hit rate over 99% is desired to avoid bottlenecks.
kamailio→lb→pkg_mem	16	This setting affects the amount of RAM the system will use. Each kamailio-lb worker will have this amount of RAM reserved. Lowering this setting up to 8 will help to release some memory depending on the number of kamailio-lb workers running. This can be a dangerous setting as the lb process could run out of memory. Use with caution.
kamailio→lb→shm_mem	1/16 * Total System RAM	The installer will set this value to 1/16 of the total system RAM. This setting does not change even if the system RAM does so it's up to the administrator to tune it. It has been calculated that 1024 (1GB) is a good value for 50K subscriber environment. For a test environment, setting the value to 64 should be enough. "Out of memory" messages in the kamailio log can indicate that this value needs to be raised.
kamailio→lb→tcp_children	8	Number of TCP workers kamailio-lb will spawn per listening socket. The value should be fine for a mixed UDP-TCP 50K subscriber system. Lowering this setting can free some RAM as the number of kamailio processes would decrease. For a test system or a pure UDP subscriber system 2 is a good value. 1 or 2 TCP workers are always needed.
kamailio→lb→tls→enable	yes	Enable or not TLS signaling on the system. Setting this value to "no" will prevent kamailio to spawn TLS listening workers and free some RAM.

Table 24: (continued)

Option	Default value	Requirement impact
<code>kamailio→lb→udp_children</code>	8	See <code>kamailio→lb→tcp_children</code> explanation
<code>kamailio→proxy→children</code>	8	See <code>kamailio→lb→tcp_children</code> explanation. In this case the proxy only listens udp so these children should be enough to handle all the traffic. It could be set to 2 for test systems to lower the requirements.
<code>kamailio→proxy→*_expires</code>		Set the default and the max and min registration interval. The lower it is more REGISTER requests will be handled by the lb and the proxy. It can impact in the network traffic, RAM and CPU usage.
<code>kamailio→proxy→natping_interval</code>	30	Interval for the proxy to send a NAT keepalive OPTIONS message to the nated subscriber. If decreased, this setting will increase the number of OPTIONS requests the proxy needs to send and can impact in the network traffic and the number of natping processes the system needs to run. See <code>kamailio→proxy→natping_processes</code> explanation.
<code>kamailio→proxy→natping_processes</code>	7	Kamailio-proxy will spawn this number of processes to send keepalive OPTIONS to the nated subscribers. Each worker can handle about 250 messages/second (depends on the hardware). Depending the number of nated subscribers and the <code>kamailio→proxy→natping_interval</code> parameter the number of workers may need to be adjusted. The number can be calculated like $\text{nated_subscribers}/\text{natping_interval}/\text{pings_per_second_per_process}$. For the default options, assuming 50K nated subscribers in the system the parameter value would be $50.000/30/250 = (6,66) 7$ workers. 7 is the maximum number of processes kamailio will accept. Raising this value will cause kamailio not to start.
<code>kamailio→proxy→shm_mem</code>	1/16 * Total System RAM	See <code>kamailio→lb→shm_mem</code> explanation.
<code>rateomat→enable</code>	yes	Set this to no if the system shouldn't perform rating on the CDRs. This will save CPU usage.
<code>rsyslog→external_log</code>	0	If enabled, the system will send the log messages to an external server. Depending on the <code>rsyslog→external_loglevel</code> parameter this can increase dramatically the network traffic.
<code>rsyslog→ngcp_logs_preserve_days</code>	93	This setting will set the number of days ngcp logs under <code>/var/log/ngcp</code> will be kept in disk. Lowering this setting will free a high amount of disk space.

Tip

In case of using virtualized environment with limited amount of hardware resources, you can use the script `ngcp-toggle-performance-config` to adjust Sipwise C5 configuration for high/low performance:

```

root@spce:~# /usr/sbin/ngcp-toggle-performance-config
/usr/sbin/ngcp-toggle-performance-config - tool to adjust Sipwise C5 configuration for low ←
    /high performance

--help          Display this usage information
--high-performance Adjust configuration for system with normal/high performance
--low-performance Adjust configuration for system with low performance (e.g. VMs)

root@spce:~#

```

16.10 Troubleshooting

The Sipwise C5 platform provides detailed logging and log files for each component included in the system via rsyslog. The main folder for log files is `/var/log/ngcp/`, it contains a list of self explanatory log files named by component name.

The Sipwise C5 is a high performance system which requires compromise between traceability (maximum amount of debug information being written to hard drive) and productivity (minimum load on IO subsystem). This is the reason why different log levels are configured for the provided components by default.

Most log files are designed for debugging Sipwise C5 by Sipwise operational team while main log files for daily routine usage are:

Log file	Content	Estimated size
<code>/var/log/ngcp/api.log</code>	API logs providing type and content of API requests and responses as well as potential errors	medium
<code>/var/log/ngcp/panel.log</code> <code>/var/log/ngcp/panel-debug.log</code>	Admin Web UI logs when performing operational tasks on the ngcp-panel	medium

Log file	Content	Estimated size
/var/log/ngcp/cdr.log	mediation and rating logs, e.g. how many CDRs have been generated and potential errors in case of CDR generation or rating fails for particular accounting data	medium
/var/log/ngcp/ha.log	fail-over related logs in case a node in a pair loses connection to the other side, when a standby node takes over or an active node goes standby due to intra-node communication issues or external ping node connection issues	small
/var/log/ngcp/kamailio-proxy.log	Overview of SIP requests and replies between lb, proxy and sems processes. It's the main log file for SIP overview	huge

Log file	Content	Estimated size
/var/log/ngcp/kamailio-lb.log	Overview of SIP requests and replies along with network source and destination information flowing through the platform	huge
/var/log/ngcp/sems.log	Overview of SIP requests and replies between lb, proxy and sems processes	small
/var/log/ngcp/rtp.log	rtpengine related log, showing information about RTP communication	small

**Warning**

it is highly NOT recommended to change default log levels as it can cause system IO overloading which will affect call processing.

Note

the exact size of log files depend on system type, system load, system health status and system configuration, so cannot be estimated with high precision. Additionally operational network parameters like ASR and ALOC may impact the log files' size significantly.

16.10.1 Collecting call information from logs

The easiest way to fetch information about a single call among the log files is the search for the SIP CallID (a unique identifier for a SIP dialog). The call ID is used as call marker in almost all the VoIP related log file, such as */var/log/ngcp/kamailio-lb.log*, */var/log/ngcp/kamailio-proxy.log*, */var/log/ngcp/sems.log* or */var/log/ngcp/rtp.log*. Example of kamailio-proxy.log line:

```
Nov 19 00:35:56 sp1 proxy[7475]: NOTICE: <script>: New request on proxy - M=REGISTER R=sip: ←
sipwise.local
F=sip:jdoe@sipwise.local T=sip:jdoe@sipwise.local IP=10.10.1.10:5060 (127.0.0.1:5060) ID ←
=364e4676776621034977934e055d19ea@127.0.0.1 UA='SIP-UA 1.2.3.4'
```

The above line shows the SIP information you can find in a general line contained in `/var/log/ngcp/kamailio-*`:

- `M=REGISTER` : The SIP Method
- `R=sip:sipwise.local` : The SIP Request URI
- `F=sip:jdoe@sipwise.local` : The SIP From header
- `T=sip:jdoe@sipwise.local` : The SIP To header
- `IP=10.10.1.10:5060 (127.0.0.1:5060)` : The source IP where the message is coming from. Between brackets it is shown the local internal IP where the message come from (in this case Load Balancer)
- `ID=364e4676776621034977934e055d19ea@127.0.0.1` : The SIP CallID.
- `UAIP=10.10.1.10` : The User Agent source IP
- `UA=SIP-UA 1.2.3.4` : The SIP User Agent header

In order to collect the full log related to a single call, it's necessary to "grep" the `/var/log/ngcp/kamailio-proxy.log` using the `ID=` string, for example:

```
# grep "364e4676776621034977934e055d19ea@127.0.0.1" /var/log/ngcp/kamailio-proxy.log
```

16.10.2 Collecting SIP traces

The Sipwise C5 platform provides several tools to collect SIP traces. It can be used Sipwise C5 `ngrep-sip` tool to collect SIP traces, for example to fetch traffic in text format from outbound and among load balancer, proxy and sems :

```
# ngrep-sip b
```

see the manual to know all the options:

```
# man ngrep-sip
```

The `ngrep` debian tool can be used in order to make a SIP trace and save it into a `.pcap` file :

```
# ngrep -s0 -Wbyline -d any -O /tmp/SIP_trace_file_name.pcap port 5062 or port 5060
```

The *sngrep* debian graphic tool as well can be used to visualize SIP trace and save them in a *.pcap* file :

```
# sngrep
```

The Sipwise C5 PRO platform provides also the native VoIP sniffer, called *ngcp-voisniff*, which provide a graphic view of all the calls passing through the platform. It can be enabled via `___/etc/ngcp-config/config.yml`:

```
voisniff:
  admin_panel: yes
  daemon:
    custom_bpf: ''
    filter:
      exclude:
        - active: '0'
          case_insensitive: '1'
          pattern: '\ncseq: *\d+ +(register|notify|options)'
      include: []
    sip_ports:
      - 5060
      - 5062
  interfaces:
    extra: []
    types:
      - sip_int
      - sip_ext
      - rtp_ext
  li_x1x2x3:
    call_id:
      del_patterns:
        - _pbx\-1(?:_[0-9]{1,10})?$
        - _b2b\-1(?:_[0-9]{1,10})?$
        - _xfer\-1(?:_[0-9]{1,10})?$
    captagent:
      cin_max: '3000'
      cin_min: '0'
      x2:
        threads: 20
  client_certificate: ''
  enable: no
  fix_checksums: no
  fragmented: no
  interface:
```

```
    excludes: []
    local_name: sipwise
    x1:
      port: '18090'
    x23:
      protocol: sipwise
    mysql_dump:
      enable: yes
      max_query_len: 67108864
      num_threads: '4'
    rtp_filter: yes
    start: yes
    threads_per_interface: '2'
  partitions:
    increment: '700000'
    keep: '10'
```

`admin_panel` should be set to `yes` as well as `start` and `mysql_dump.enable`. Also `filter.exclude.active` should be set to `1` in order to avoid to sniff REGISTER, NOTIFY, OPTIONS and SUBSCRIBE messages. Then run:

```
ngcpcfg apply 'enable voisniff' && ngcpcfg push
```



Warning

Please notice that enabling `voisniff`, specially under a huge amount of traffic, may affect the system performance due to the fact that `voisniff` needs to save all the traffic into the database.

16.11 Log file obfuscation

As many of the log files produced by Sipwise C5 contain sensitive and private data, and as various jurisdictions around the world have placed restrictions on who can view whose private data (e.g. GDPR in the EU), Sipwise C5 provides a mechanism to safely view log files in a partially obfuscated and anonymised (pseudonymised) fashion.

This obfuscated view is provided by the system service `ngcp-logfs` and is enabled by default. This service provides a read-only, partially obfuscated view of the Sipwise C5 log files in a separate folder, which by default is `/var/log/mirror-ngcp/`. The actual log files in `/var/log/ngcp/` are normally readable only by the system administrator (`root`), while the obfuscated view of them in `/var/log/mirror-ngcp/` is readable even by non-administrator system users by default.

Log files produced by Sipwise C5 contain special markers that identify data fields that correspond to private data belonging to 3rd parties. When accessing the log files through `ngcp-logfs`, the data contained in these fields will be replaced by other, seemingly random strings. However, this replacement is deterministic, meaning that the same original string will always be replaced with the same obfuscated string, making it still possible to correlate log lines belonging to the same entity, even across log files from different applications. Examples of such obfuscated data fields are user names, phone numbers, IP addresses, and other uniquely identifiable data fields.

The `ngcp-logfs` service also provides the same kind of access to archived (rotated) log files contained in `/var/log/ngcp/old/`. While these log files are compressed (`.gz`) on disk, they appear as uncompressed, plain text files when viewed through `ngcp-logfs`, as the service decompresses them in the background on demand.

16.11.1 Configuration

The service can be configured via its respective section in `/etc/ngcp-config/config.yml`:

```
logfs:
  cache_db: /usr/lib/ngcp-logfs/cache.db
  chmod_dirs: '0555'
  chmod_files: '0444'
  disk_retention_timeout: 365
  enable: yes
  file_cache_timeout: 2
  gid: 0
  log_dir: /var/log/ngcp
  max_mem_usage: 500
  mem_cache_timeout: 24
  mountpoint: /var/log/mirror-ngcp
  obfuscation_prefix: GDPR
  suffix: \.\.d+$|-\d{8}$|-\d{8}-\d+$
  uid: 0
```

- `cache_db`: path and file name of the on-disk cache for obfuscated strings and their replacements. Does not normally need to be changed.
- `chmod_dirs`: Unix file mode for directories visible through `ngcp-logfs` in octal. Defaults to octal 0555 (world readable).
- `chmod_files`: Unix file mode for log files visible through `ngcp-logfs` in octal. Defaults to octal 0444 (world readable).
- `disk_retention_timeout`: how long to store obfuscated strings in the on-disk cache before they get deleted, in days. Defaults to 365 (one year).
- `enable`: master switch for the service itself, yes or no.
- `file_cache_timeout`: how long to cache obfuscated files (portions or entirely) in memory, in hours. Defaults to 2 hours.
- `gid`: numeric Unix group ID for presented files and directories. Defaults to 0 (root).
- `log_dir`: root directory of the log files that should be mirrored. Does not normally need to be changed.
- `max_mem_usage`: upper limit in megabytes for the in-memory cache for obfuscated files. If this limit is hit, the in-memory cache will start to get aggressively emptied, even if `file_cache_timeout` isn't yet reached. Defaults to 500 MB.
- `mem_cache_timeout`: how long to cache obfuscated strings and their replacements in memory, in hours. Defaults to 24 hours.

- `mountpoint`: where to make obfuscated log files visible in the file system.
- `obfuscation_prefix`: optional prefix that obfuscated strings are guaranteed to have, provided the string is at least twice as long as the prefix. The prefix therefore should be kept short. Can be empty to disable this feature.
- `suffix`: regular expression to match the file name suffix for archived (rotated) log files. Does not normally need to be changed.
- `uid`: numeric Unix user ID for presented files and directories. Defaults to 0 (root).

Tip

Access to obfuscated log files can be further restricted by setting `chmod_files`, `chmod_dirs` and `uid` and/or `gid`. For example, to make log files accessible only to users belonging to the system group `adm` with group ID 4, set `gid` to 4, set `chmod_files` to 0440, and `chmod_dirs` to 0550, followed by executing `ngcpfg apply`.

16.11.2 Forward and reverse lookup

In some cases, for example for troubleshooting purposes, it can be necessary to determine the underlying unobfuscated plain text string from its obfuscated version, or perhaps even vice versa. For this purpose, the tool `ngcp-lookup-obfuscated` is provided, which can only be used by the system administrator (`root`). To perform a forward lookup (obfuscated string to unobfuscated), simply call it with the obfuscated string as its first argument. To perform a reverse lookup (unobfuscated to obfuscated), add the `-r` option.

For example, take the following sample log line provided by `ngcp-logfs`:

```
Mar 28 06:00:27 sp1 proxy[2544]: NOTICE: <script>: Sending reply S=200 Alive fs=' ←  
127.0.0.1:5062' du='127.0.0.1:5060' - R=«GDPRcarPrUHeRvvWF2JjGei2Lu0bUjQIgI» ID= ↔  
«GDPRqOB2kvuAm0JC7zQN6E1w4K» UA='sipsak 0.9.7pre'
```

The following commands would be used to perform both forward and reverse lookups on the call ID:

```
root@sp1:~# ngcp-lookup-obfuscated GDPRqOB2kvuAm0JC7zQN6E1w4K  
1899127565@192.168.255.251  
root@sp1:~# ngcp-lookup-obfuscated -r 1899127565@192.168.255.251  
GDPRqOB2kvuAm0JC7zQN6E1w4K
```

Note

These lookups, in particular the reverse lookup, only work on strings that were actually processed by `ngcp-logfs`. You cannot use the reverse lookup procedure to obfuscate any arbitrary string that wasn't previously provided by `ngcp-logfs`. The lookup must also be performed on the same host on which `ngcp-logfs` performed the obfuscation. Lookups don't necessarily work on other hosts.

16.12 NGCP Panel passwords encryption

Encryption is used in case of administrator users passwords. Starting with *mr8.4* release, subscribers web passwords are also encrypted the same way administrator passwords are by default.

In case you have upgraded from an earlier version where the passwords were plain text, the `ngcp-bcrypt-webpassword` can be used, which will encrypt all subscribers web passwords.

17 Monitoring and Alerting

17.1 Internal Monitoring

17.1.1 Service monitoring

The platform uses both *systemd* and *monit* daemons to monitor all essential services. Since Sipwise C5 runs in an active/standby mode, not all services are always running on both nodes, some of them will only run on the active node and be stopped on the standby node. The following commands show the most critical services on the platform: `* ngcp-service summary` - to get the list of services and their current status, `* systemctl status` - to get a tree of the services running, `* systemctl list-units` - to get a list of the service states, `* monit summary` - to get the list of services known to monit and their current status, `* monit status` - to get the list of services known to monit with detailed status.



Important

When you perform a stop/start/monitor/unmonitor operation on a service, *monit* affects other services that depend on the initial one. Hence, if you stop or unmonitor a service all services that depend on it will be stopped or unmonitored as well.

For example, `monit stop mysql` operation will stop *kamailio*, *sbc*, *asterisk*, *prosody* and some other services. Although the recommended way to operate on services is via the *ngcp-service* wrapper which will take care of abstracting the underlying process monitoring implementation.

If any service ever fails for whatever reason either the *systemd* or *monit* daemons will quickly restart it. When that happens, the daemon will send a notification email to the address specified in the `config.yml` file under the `general.adminmail` key. It will also send warning emails to this address under certain abnormal conditions, such as high memory consumption (> 75% is used) or high CPU load.



Important

In order for *monit* to be able to send emails to the specified address, the local MTA (*exim4*) must be configured correctly. The CE edition's handbook contains more information about this in the *Installation* chapter.

17.1.2 System monitoring via Telegraf

The platform uses the internal *telegraf* service to monitor many aspects of the system, including CPU, memory, swap, disk, filesystem, network, processes, NTP, Nginx, Redis and MySQL.

The gathered information is stored in *InfluxDB*, in the *telegraf* database.

17.1.3 Sipwise C5 specific monitoring via ngcp-witnessd

The platform uses the internal *ngcp-witnessd* service to monitor Sipwise C5 specific metrics or system metrics currently not tracked by *telegraf*, including memory, process count, HA status, MTA, Kamailio, SIP and MySQL.

The gathered information is stored in *InfluxDB*, in the *ngcp* database.

17.1.4 Monitoring data in InfluxDB

The platform uses *InfluxDB* as a time series database, to store most of the metrics collected in the system.

On a Sipwise C5 each node stores its own metrics and the ones for their peer node, and in addition on CARRIER systems the management nodes store the metrics for all the nodes in the cluster. This is done via *influxdb-relay* which listens for *InfluxDB* writes and multiplexes them to the local node and any other node necessary.

The monitoring data is used by various components of the platform, including *ngcp-collective-check*, *ngcp-snmp-agent* and by the statistics dashboard powered by *Grafana*.

The monitoring data can also be accessed directly by various means; by using the *influx* command-line tool in CLI or TUI modes; by using the *ngcp-influxdb-extract* wrapper which provides two convenience commands to run arbitrary queries or to fetch the last value for a measurement's field; or by using the HTTP API with *curl* (or other HTTP fetchers), or with the *NGCP::InfluxDB::HTTP* perl module.

See https://docs.influxdata.com/influxdb/v1.1/query_language/spec/ for information about InfluxQL, the query language used by *InfluxDB*.

Tip

To get the list of all measurements for a specific database the following query can be used `SHOW MEASUREMENTS`.

Tip

To get the list of fields for a specific measurement the following query can be used `SELECT LAST(*) FROM "measurement"`.

Tip

To get the list of tags for a specific measurement the following query can be used `SHOW TAG KEYS FROM "measurement"`, and for all the current tag values for a tag `SHOW TAG VALUES FROM "measurement" WITH KEY = "tag"`.

See Section [1.3](#) for detailed information about the list of data currently stored in the *InfluxDB ngcp* monitoring database.

17.2 Statistics Dashboard

The platform's administration interface (described in Section [5](#)) provides a graphical overview based on *Grafana* of the most important system health indicators, such as memory usage, load averages and disk usage. VoIP statistics, such as the number of concurrent active calls, the number of provisioned and registered subscribers, etc. is also present.

17.3 External Monitoring Using SNMP

17.3.1 Overview and Initial Setup

The Sipwise C5 exports a variety of cluster health data and statistics over the standard SNMP interface. By default, the SNMP interface can only be accessed locally. To make it possible to provide the SNMP data to an external system, the `config.yml` file needs to be edited and the list of allowed community names and allowed hosts/IP ranges must be populated. This list can be found under the `snmpd.communities` key and it consists of one or more hashes of `name` and `sources` key/values. The community `name` is the allowed community name, while `sources` is a list of IP address or IP blocks where to allow the requests from.

The SNMP notifications (or traps) can also be configured in a similar way, to send them to an external system, by populating the `snmpd.trap_communities` key with `name` and `targets` key/values. The community trap `name` is the value that will be used when sending the trap, while the `targets` is a list of IP addresses where to send the trap.

The `public` communities with the `localhost` source and target are used for local testing of SNMP functionality. It is recommended that you leave these entries in place. Other legal `sources` can be formed as single IP addresses or IP blocks in IP/prefix notation, for example `192.168.115.0/24`. Other `targets` can be formed as single IP addresses.

The origin of the SNMP notifications for the SIPWISE MIB can also be configured with the `snmpagent.traps_origin`. The supported modes are:

- `legacy`: The node triggering the condition and its peer (if available) will emit the trap, in addition the management node pair (if distinct) will also emit the trap. This is the original behavior and the current default.
- `mgmt`: Only the active management node will emit the trap.
- `distributed`: Only the node triggering the condition will emit the trap. For cluster-wide conditions, this mode is equivalent to the `mgmt` mode.

Tip

To locally check if SNMP is working correctly, execute the command `snmpwalk -v2c -cpublic localhost .` (note the trailing dot). This will generate a long list of raw SNMP OIDs and their values, provided that the `default` SNMP community key has been left in place.

Tip

To locally check if SNMP notifications (or traps) are working correctly, install the `snmptrapd` package, which will be configured by default to catch the traps sent by the `localhost` SNMP agent. The traps will show up on `/var/log/daemon.log`, and a couple of traps can be generated simply by running `ngcp-service restart snmpd`.

Note

SNMP version 1 and version 2c are supported.

17.3.2 Details

There are two types of information that can be retrieved from SNMP. The first one is the native Sipwise C5 cluster overview from Sipwise C5 MIBs (Management Information Bases). The second is the legacy ad-hoc information using the Net-SNMP extension OIDs, and detailed information for the node running the SNMP daemon using standard OIDs (Object Identifiers).

17.3.2.1 Sipwise C5 OIDs

The entire Sipwise C5 cluster can be monitored by using the `SIPWISE-NGCP-MIB`, `SIPWISE-NGCP-MONITOR-MIB` and `SIPWISE-NGCP-STATS-MIB`. These OIDs are rooted at Sipwise C5 slot `.1.3.6.1.4.1.34274.1.*`.

The MIBs are self-documented, and can be found as part of the `ngcp-snmp-mibs` package (running `dpkg -S SIPWISE*MIB` will list their pathnames). The Sipwise C5 SNMP Agent is a part of the `ngcp-snmp-agent` package, which is installed by default and works out-of-the-box as long as the `snmpd` has been properly configured.

The `SIPWISE-NGCP-MIB` acts as the root MIB and provides information about the cluster licensing and layout (which is mostly static data about each node, such as node name, its IP address, its roles, etc.) and information required to access the OIDs from the other MIBs.

The `SIPWISE-NGCP-MONITOR-MIB` provides current monitoring information, global health conditions, the number of provisioned and registered subscribers and devices. It also provides per node information (independently of the number of nodes or their names) on their filesystem, processes, databases, system load, memory, HA status, MTA queues, etc.

The `SIPWISE-NGCP-STATS-MIB` provides accumulated statistics on billing, performance and processed SIP messages.

Note

OIDs under the following trees are not yet implemented: `ngcpMonitorFraud`, `ngcpMonitorPerformance.perfCAPSCurTable` and `ngcpStats` (except for `ngcpStats.ngcpStatsBilling.billingCDRGenerated` and `ngcpStats.ngcpStatsBilling.billingCDRGenerated` which are implemented).

Note

The Sipwise C5 SNMP Agent uses `Redis` and `InfluxDB` as data sources. This data is essential for accurate and complete monitoring data in the SNMP OID tree. In addition, the `Redis` database must be available on a shared IP address, so that `ngcp-witnessd` can always write to it.

17.3.2.2 Legacy OIDs

Note

The following OIDs have been superseded by Sipwise C5 OIDs, but they are still provided for backwards compatibility.

All basic system health variables (such as memory, disk, swap, CPU usage, network statistics, process lists, etc.) for the `mgmt` node can be found in standard OID slots from standard MIBs. For example, memory statistics can be found through the `UCD-SNMP-MIB` in OIDs such as `memTotalSwap.0`, `memAvailSwap.0`, `memTotalReal.0`, `memAvailReal.0`, etc., which

translate to numeric OIDs `.1.3.6.1.4.1.2021.4.*`. In fact, `UCD-SNMP-MIB` is the most useful MIB for overall system health checks.

Additionally, there's a list of specially monitored processes, also found through the `UCD-SNMP-MIB`. `UCD-SNMP-MIB::prNames` (`.1.3.6.1.4.1.2021.2.1.2`) gives the list of monitored processes, `prCount` (`.1.3.6.1.4.1.2021.2.1.5`) is how many of each process are running and `prErrorFlag` (`.1.3.6.1.4.1.2021.2.1.100`) gives a 0/1 error indication (with `prErrorMessage` (`.1.3.6.1.4.1.2021.2.1.101`) providing an explanation of any error).

Tip

Some of these processes are not supposed to be running on the standby node, so you'll see the error flag raised there. A possible solution is to run these SNMP checks against the shared service IP of the cluster. See in Section 2.7 below for more information.

Furthermore, `UCD-SNMP-MIB` provides a list of custom external checks. The names of these can be found under the `UCD-SNMP-MIB::(.2)` tree, with `extOutput` (`.101`) providing the output (one line) from each check and `extResult` (`.100`) the exit code from each check.

The first of these external checks called `collective_check` provides a combined and overall system health status indicator. It gathers information from both nodes and returns `0` in `extResult.1` (`.100.1`) if everything is OK and running as it should. If it finds a problem somewhere, but with the system still operational (e.g. a service is stopped on the inactive node), `extResult.1` will return `1` and `extOutput.1` will be set to a string that can be used to diagnose the problem. In case the system is found in a critical and non-operational state, `extResult.1` will return `2`, again with an error message set. If you want to keep it really simple, you can just monitor this one OID and raise an alarm if it ever goes to non-zero.

Note

The 0/1/2 status codes allow for easy integration with *Nagios*.

The remaining external checks simply return statistics on the system, they all return a number in `extOutput` and have `extResult` always set to zero.

The full list of such checks is below. All of these checks have three modes: the first returns the statistics from `sp1` (the first node in Sipwise C5 pair), the second - from `sp2`, and the third - from whichever node is being queried (which is useful when querying the shared service IP). For example, the local SIP response time from `sp1` is in `sip_check_sp1`, from `sp2` - is in `sip_check_sp2`, and from the host itself - is in `sip_check_self`.

The base OID of the Result and Output OIDs is always `.1.3.6.1.4.1.2021.8.1`, so if you read `.100.1`, the full OID is `.1.3.6.1.4.1.2021.8.1.100.1`.

Name in MIB	Result OID	Output OID	Name	Description
UCD-SNMP-MIB::extNames.1	.100.1	.101.1	<code>collective_check</code>	Summarized platform check
UCD-SNMP-MIB::extNames.2	.100.2	.101.2	<code>sip_check_sp1</code>	SIP response time in seconds on <code>sp1</code>
UCD-SNMP-MIB::extNames.3	.100.3	.101.3	<code>sip_check_sp2</code>	SIP response time in seconds on <code>sp2</code>

Name in MIB	Result OID	Output OID	Name	Description
UCD-SNMP-MIB::extNames.4	.100.4	.101.4	mysql_check_sp1	Average number of MySQL queries per second on sp1
UCD-SNMP-MIB::extNames.5	.100.5	.101.5	mysql_check_sp2	Average number of MySQL queries per second on sp2
UCD-SNMP-MIB::extNames.6	.100.6	.101.6	mysql_replication_check_sp1	MySQL replication delay in seconds on sp1
UCD-SNMP-MIB::extNames.7	.100.7	.101.7	mysql_replication_check_sp2	MySQL replication delay in seconds on sp2
UCD-SNMP-MIB::extNames.8	.100.8	.101.8	mpt_check_sp1	RAID status on sp1
UCD-SNMP-MIB::extNames.9	.100.9	.101.9	mpt_check_sp2	RAID status on sp2
UCD-SNMP-MIB::extNames.10	.100.10	.101.10	exim_queue_check_sp1	Number of mails undelivered in MTA queue on sp1
UCD-SNMP-MIB::extNames.11	.100.11	.101.11	exim_queue_check_sp2	Number of mails undelivered in MTA queue on sp2
UCD-SNMP-MIB::extNames.12	.100.12	.101.12	provisioned_subscribers_sp1	Number of subscribers provisioned on sp1
UCD-SNMP-MIB::extNames.13	.100.13	.101.13	provisioned_subscribers_sp2	Number of subscribers provisioned on sp2
UCD-SNMP-MIB::extNames.14	.100.14	.101.14	kam_dialog_active_check_sp1	Number of active calls on sp1
UCD-SNMP-MIB::extNames.15	.100.15	.101.15	kam_dialog_active_check_sp2	Number of active calls on sp2
UCD-SNMP-MIB::extNames.16	.100.16	.101.16	kam_dialog_early_check_sp1	Number of calls in Early Media state on sp1
UCD-SNMP-MIB::extNames.17	.100.17	.101.17	kam_dialog_early_check_sp2	Number of calls in Early Media state on sp2
UCD-SNMP-MIB::extNames.18	.100.18	.101.18	kam_dialog_type_local_sp1	Number of active calls local on sp1
UCD-SNMP-MIB::extNames.19	.100.19	.101.19	kam_dialog_type_local_sp2	Number of active calls local on sp2

Name in MIB	Result OID	Output OID	Name	Description
UCD-SNMP-MIB::extNames.20	.100.20	.101.20	kam_dialog_type_relay	Number of active calls routed via peers on sp1
UCD-SNMP-MIB::extNames.21	.100.21	.101.21	kam_dialog_type_relay	Number of active calls routed via peers on sp2
UCD-SNMP-MIB::extNames.22	.100.22	.101.22	kam_dialog_type_incoming	Number of incoming calls on sp1
UCD-SNMP-MIB::extNames.23	.100.23	.101.23	kam_dialog_type_incoming	Number of incoming calls on sp2
UCD-SNMP-MIB::extNames.24	.100.24	.101.24	kam_dialog_type_outgoing	Number of outgoing calls on sp1
UCD-SNMP-MIB::extNames.25	.100.25	.101.25	kam_dialog_type_outgoing	Number of outgoing calls on sp2
UCD-SNMP-MIB::extNames.26	.100.26	.101.26	kam_usrloc_regusers	Number of subscribers with at least one active registration on sp1
UCD-SNMP-MIB::extNames.27	.100.27	.101.27	kam_usrloc_regusers	Number of subscribers with at least one active registration on sp2
UCD-SNMP-MIB::extNames.28	.100.28	.101.28	kam_usrloc_regdevices	Total number of registered end devices on sp1
UCD-SNMP-MIB::extNames.29	.100.29	.101.29	kam_usrloc_regdevices	Total number of registered end devices on sp2
UCD-SNMP-MIB::extNames.30	.100.30	.101.30	mysql_replication_discrepancy	Number of MySQL tables not in sync between sp1 and sp2
UCD-SNMP-MIB::extNames.31	.100.31	.101.31	mysql_replication_discrepancy	Number of MySQL tables not in sync between sp1 and sp2
UCD-SNMP-MIB::extNames.32	.100.32	.101.32	sip_check_self	Summarized platform check on active node
UCD-SNMP-MIB::extNames.33	.100.33	.101.33	mysql_check_self	Average number of MySQL queries per second on active node
UCD-SNMP-MIB::extNames.34	.100.34	.101.34	mysql_replication_check	MySQL replication delay in seconds on active node

Name in MIB	Result OID	Output OID	Name	Description
UCD-SNMP-MIB::extNames.35	.100.35	.101.35	mpt_check_self	RAID status on active node
UCD-SNMP-MIB::extNames.36	.100.36	.101.36	exim_queue_check_self	Number of mails undelivered in MTA queue on active node
UCD-SNMP-MIB::extNames.37	.100.37	.101.37	provisioned_subscribers	Number of subscribers provisioned on active node
UCD-SNMP-MIB::extNames.38	.100.38	.101.38	kam_dialog_active_check_self	Number of active calls on active node
UCD-SNMP-MIB::extNames.39	.100.39	.101.39	kam_dialog_early_check_self	Number of calls in Early Media state on active node
UCD-SNMP-MIB::extNames.40	.100.40	.101.40	kam_dialog_type_local_check_self	Number of active calls local on active node
UCD-SNMP-MIB::extNames.41	.100.41	.101.41	kam_dialog_type_relay_check_self	Number of active calls routed via peers on active node
UCD-SNMP-MIB::extNames.42	.100.42	.101.42	kam_dialog_type_incoming_check_self	Number of incoming calls on active node
UCD-SNMP-MIB::extNames.43	.100.43	.101.43	kam_dialog_type_outgoing_check_self	Number of outgoing calls on active node
UCD-SNMP-MIB::extNames.44	.100.44	.101.44	kam_usrloc_regusers_check_self	Number of subscribers with at least one active registration on active node
UCD-SNMP-MIB::extNames.45	.100.45	.101.45	kam_usrloc_regdevices_check_self	Number of registered end devices on active node
UCD-SNMP-MIB::extNames.46	.100.46	.101.46	mysql_replication_discrepancy	Number of MySQL tables not in sync between sp1 and sp2
UCD-SNMP-MIB::extNames.47	.100.47	.101.47	kam_dialog_type_local_check_proxy_X	Number of active local calls on active proxy X (CARRIER-only)
UCD-SNMP-MIB::extNames.48	.100.48	.101.48	kam_dialog_type_relay_check_proxy_X	Number of active calls routed via peers on active proxy X (CARRIER-only)

Name in MIB	Result OID	Output OID	Name	Description
UCD-SNMP-MIB::extNames.49	.100.49	.101.49	kam_dialog_type_incoming	Number of incoming calls on active proxy X (CARRIER-only)
UCD-SNMP-MIB::extNames.50	.100.50	.101.50	kam_dialog_type_outgoing	Number of outgoing calls on active proxy X (CARRIER-only)
UCD-SNMP-MIB::extNames.51	.100.51	.101.51	kam_dialog_active_checks	Number of active calls on active proxy X (CARRIER-only)
UCD-SNMP-MIB::extNames.52	.100.52	.101.52	kam_dialog_early_checks	Number of calls in Early Media state on active proxy X (CARRIER-only)

Tip

Some of the data gathering can be disabled (most are enabled by default) through the `config.yml` file, and those data points will then return an error message or an empty string in their `extOutput`. Enable those data points in the config file to get their output in the SNMP OID tree. The enable/disable flags can be found in the `witnessd.gather` section.

18 Extensions and Additional Modules

18.1 Cloud PBX

The Sipwise C5 comes with a commercial Cloud PBX module to provide B2B features for small and medium sized enterprises. The following chapters describe the configuration of the PBX features.

18.1.1 PBX Device Provisioning

18.1.1.1 How it works

A device gets provisioned with the following steps:

- Your customer creates a PBX device for a supported model and inputs a device's MAC address.
- Sipwise C5 sends the provided MAC address to the device vendor (e.g. rps.yealink.com).
- When the corresponding device is connected to the network, the device fetches the provisioning URL from the vendor site.
- The device downloads its specific configuration and the firmware from Sipwise C5.
- The phone updates the firmware and automatically sets the SIP proxy server, username and password and other SIP parameters received from Sipwise C5.

PBX device provisioning requires appropriate device models, firmwares, configurations and profiles to be added to the system.

A *device model* defines a specific hardware device, like the vendor, the model name, the number of keys and their capabilities. For example, a Cisco SPA504G has 4 keys, which can be used for private lines, shared lines (SLA) and busy lamp field (BLF). If you have an additional attendant console, you get 32 more buttons, which can only do BLF. The list of supported devices can be found in Section [18.1.13](#).

A *device firmware* is used to update a potentially outdated factory firmware on a device. The default firmwares included in Sipwise C5 were tested with the provided device configurations and hence guarantee that all the supported features work as expected. That is why we recommend using the default firmwares and device configurations provided by Sipwise.

To make device provisioning easy-to-use for end-users, they do not have to care about firmwares or configurations mentioned above. Instead, you provide a *device profile* for every supported device model and associate such a device profile with a specific device configuration and firmware. When a customer employee with administrative rights provisions PBX devices for the company, he just selects the corresponding device profiles and specifies MAC addresses if necessary. Sipwise C5 will take care of the rest.

Sipwise C5 is supplied with a set of supported device models, their firmwares, configurations and profile. You can just enable them and your customers will be able to use PBX device provisioning immediately.

To perform basic configuration and upload the set for a specific vendor, device model(s) or for all supported devices, execute the steps described in the following section.

18.1.1.2 Initial device provisioning configuration

Execute the following initial steps before your customers can easily and securely provision their PBX devices:

1. Set the certificates and the keys for your HTTPs FQDN
2. Upload the required device models/firmwares/configurations/profiles

18.1.1.3 Set the certificates and the key for your web domain

You can create new ones or use the existing certificate and the key for your web FQDN.

- Put the required files into the `/etc/ngcp-config/ssl` folder.
- Specify the paths to the files and the FQDN in the following config.yml parameters:
 - **server_certfile**
 - **server_keyfile**
 - Specify the FQDN in **autoprov.server.host**
 - Optionally, enable **nginx_debug**

The final configuration should look similar to this one:

```
autoprov:
  hardphone:
    skip_vendor_redirect: no
  server:
    bootstrap_port: '1445'
    ca_certfile: /etc/ngcp-config/ssl/client-auth-ca.crt
    host: portal.yourdomain.com
    nginx_debug: yes
    port: '1444'
    server_certfile: /etc/ngcp-config/ssl/certificate.pem
    server_keyfile: /etc/ngcp-config/ssl/private_key.pem
    ssl_enabled: yes
  softphone:
    config_lockdown: '0'
    webauth: '0'
```

- Apply and push the changes

```
ngcpcfg apply 'PBX device provisioning configuration'
ngcpcfg push all
```

18.1.1.4 Upload the required device items

To upload device models/firmwares/configurations/profiles for devices with ZTP support, you need to obtain credentials from the corresponding vendor or its local distributor in advance. These credentials are required to send information about your devices and their provisioning URLs to the corresponding ZTP/RPS systems.

The `/usr/sbin/ngcp-insert-pbx-devices.pl` script will insert the specified items into the database. For example, to upload items for all supported Yealink devices for the default reseller, execute the script with the following parameters on your management node (standby on PRO; web01a/db01a on CARRIER):

```
/usr/sbin/ngcp-insert-pbx-devices.pl --api-user youruser --api-pass yourpassword --yealink- ↵  
user user --yealink-password password
```

Tip

Execute `/usr/sbin/ngcp-insert-pbx-devices.pl --help` to find other useful parameters, e.g. `--device-models`, `--resellers` and others.

18.1.2 Preparing PBX Rewrite Rules

In a PBX environment, the dial-plans usually looks different than for normal SIP subscribers. PBX subscribers should be able to directly dial internal extensions (e.g. 100) instead of the full number to reach another PBX subscriber in the same PBX segment. Therefore, we need to define specific *Rewrite Rules* to make this work.

The PBX dial plans are different from country to country. In the Central European area, you can directly dial an extension (e.g. 100), and if you want to dial an international number like 0049 1 23456, you have to dial a break-out digit first (e.g. 0), so the number to be dialed is 0 0049 1 23456. Other countries are used to other break-out codes (e.g. 9), which then results in 9 0049 1 23456. If you dial a national number like 01 23456, then the number to actually be dialled is 9 01 23456.

Since all numbers must be normalized to E.164 format via inbound rewrite rules, the rules need to be set up accordingly.

Let's assume that the break-out code for the example customers created below is 0, so we have to create a *Rewrite Rule Set* with the following rules.

18.1.2.1 Inbound Rewrite Rules for Caller

- **Match Pattern:** `^([1-9][0-9]+)$`
- **Replacement Pattern:** `${caller_cloud_pbx_base_cli}\1`
- **Description:** extension to e164
- **Direction:** Inbound
- **Field:** Caller

Logged in as administrator Logout

sip:wise NGCP Dashboard

Home Settings

Rewrite Rules for pbx-at

Back Create Rewrite Rule Expand Groups

Rewrite rule successfully created

Inbound Rewrite Rules for Caller

	Match Pattern	Replacement Pattern	Description	
↑ ↓	<code>^([1-9][0-9]+)\$</code>	<code>\${caller_cloud_pbx_base_cli}\1</code>	extension to e164	

Inbound Rewrite Rules for Callee

Outbound Rewrite Rules for Caller

Outbound Rewrite Rules for Callee

Figure 120: Inbound Rewrite Rule for Caller

18.1.2.2 Inbound Rewrite Rules for Callee

These rules are the most important ones, as they define which number formats the PBX subscribers can dial. For the break-out code of 0, the following rules are necessary e.g. for German dialplans to allow pbx internal extension dialing, local area calls without area codes, national calls with area code, and international calls with country codes.

PBX INTERNAL EXTENSION DIALIN

- **Match Pattern:** `^([1-9][0-9]+)$`
- **Replacement Pattern:** `${caller_cloud_pbx_base_cli}\1`
- **Description:** extension to e164
- **Direction:** Inbound
- **Field:** Callee

LOCAL DIALING WITHOUT AREA CODE (USE BREAK-OUT CODE 0)

- **Match Pattern:** `^0([1-9][0-9]+)$`
- **Replacement Pattern:** `${caller_cc}${caller_ac}\1`
- **Description:** local to e164
- **Direction:** Inbound
- **Field:** Callee

NATIONAL DIALING (USE BREAK-OUT CODE 0 AND PREFIX AREA CODE BY 0)

- **Match Pattern:** `^00([1-9][0-9]+)$`
- **Replacement Pattern:** `${caller_cc}\1`
- **Description:** national to e164
- **Direction:** Inbound
- **Field:** Callee

INTERNATIONAL DIALING (USE BREAK-OUT CODE 0 AND PREFIX COUNTRY CODE BY 00)

- **Match Pattern:** `^000([1-9][0-9]+)$`
- **Replacement Pattern:** `\1`
- **Description:** international to e164
- **Direction:** Inbound
- **Field:** Callee

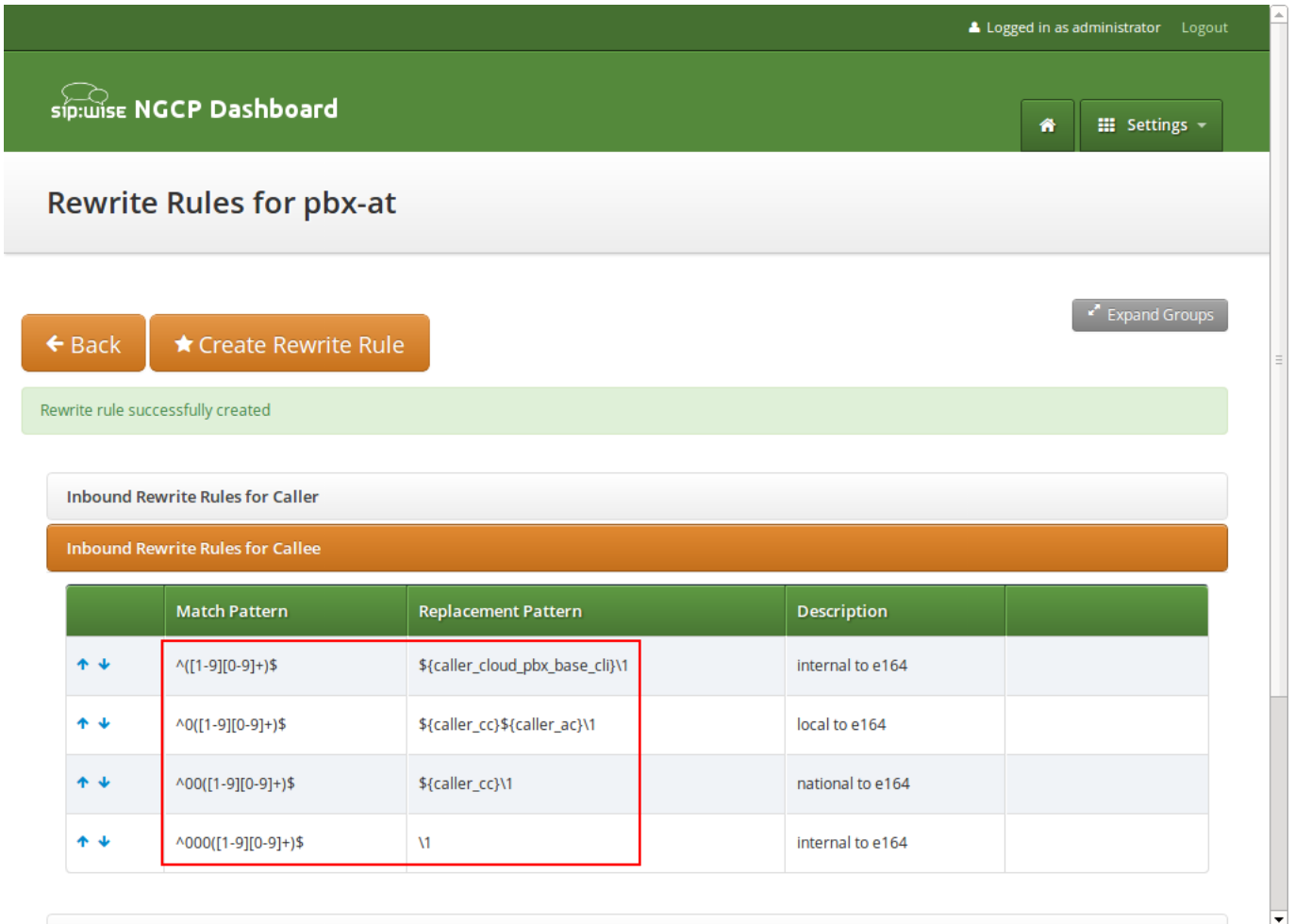

Figure 121: Inbound Rewrite Rule for Callee

18.1.2.3 Outbound Rewrite Rules for Caller

When a call goes to a PBX subscriber, it needs to be normalized in a way that it's call-back-able, which means that it needs to have the break-out code prefixed. We create a rule to show the calling number in international format including the break-out code. For PBX-internal calls, the most common setting is to show the short extension of the caller and caller name that is provisioned to a PBX subscriber (in order to do that just set domain preferences *outbound_from_display* and *outbound_from_user* accordingly, so you don't have to worry about that in rewrite rules).

ADDING A BREAK-OUT CODE (USE BREAK-OUT CODE 0 AND PREFIX COUNTRY CODE BY 00)

- **Match Pattern:** `^([1-9][0-9]+)$`
- **Replacement Pattern:** `000\1`
- **Description:** e164 to full international
- **Direction:** Outbound
- **Field:** Caller

The screenshot shows the 'sip:wise NGCP Dashboard' interface. At the top, there is a navigation bar with a home icon, 'Documentation', 'Monitoring & Statistics', 'Tools', and 'Settings'. The main heading is 'Rewrite Rules for pbx-at'. Below this, there are buttons for 'Back' and 'Create Rewrite Rule', and an 'Expand Groups' button. The interface is divided into three sections: 'Inbound Rewrite Rules for Caller', 'Inbound Rewrite Rules for Callee', and 'Outbound Rewrite Rules for Caller'. The 'Outbound Rewrite Rules for Caller' section contains a table with the following data:

	Match Pattern	Replacement Pattern	Description	Enabled	
↑ ↓	^@{callee_cloud_pbx_account_cli_list}\$	#{caller_cloud_pbx_ext}	Intra-PBX to extension	yes	
↑ ↓	^([1-9][0-9]+)\$	0001	e164 to full international	yes	

Figure 122: Outbound Rewrite Rule for Caller

Create a new *Rewrite Rule Set* for each dial plan you'd like to support. You can later assign it to customer domains and even to subscribers, if a specific subscriber of a PBX customer would like to have his own dial plan.

18.1.3 Creating Customers and Pilot Subscribers

As with a normal SIP Account, you have to create a *Customer* contract per customer, and one *Subscriber*, which the customer can use to log into the web interface and manage his PBX environment.

18.1.3.1 Creating a PBX Customer

Go to *Settings* → *Customers* and click *Create Customer*. We need a *Contact* for the customer, so press *Create Contact*.

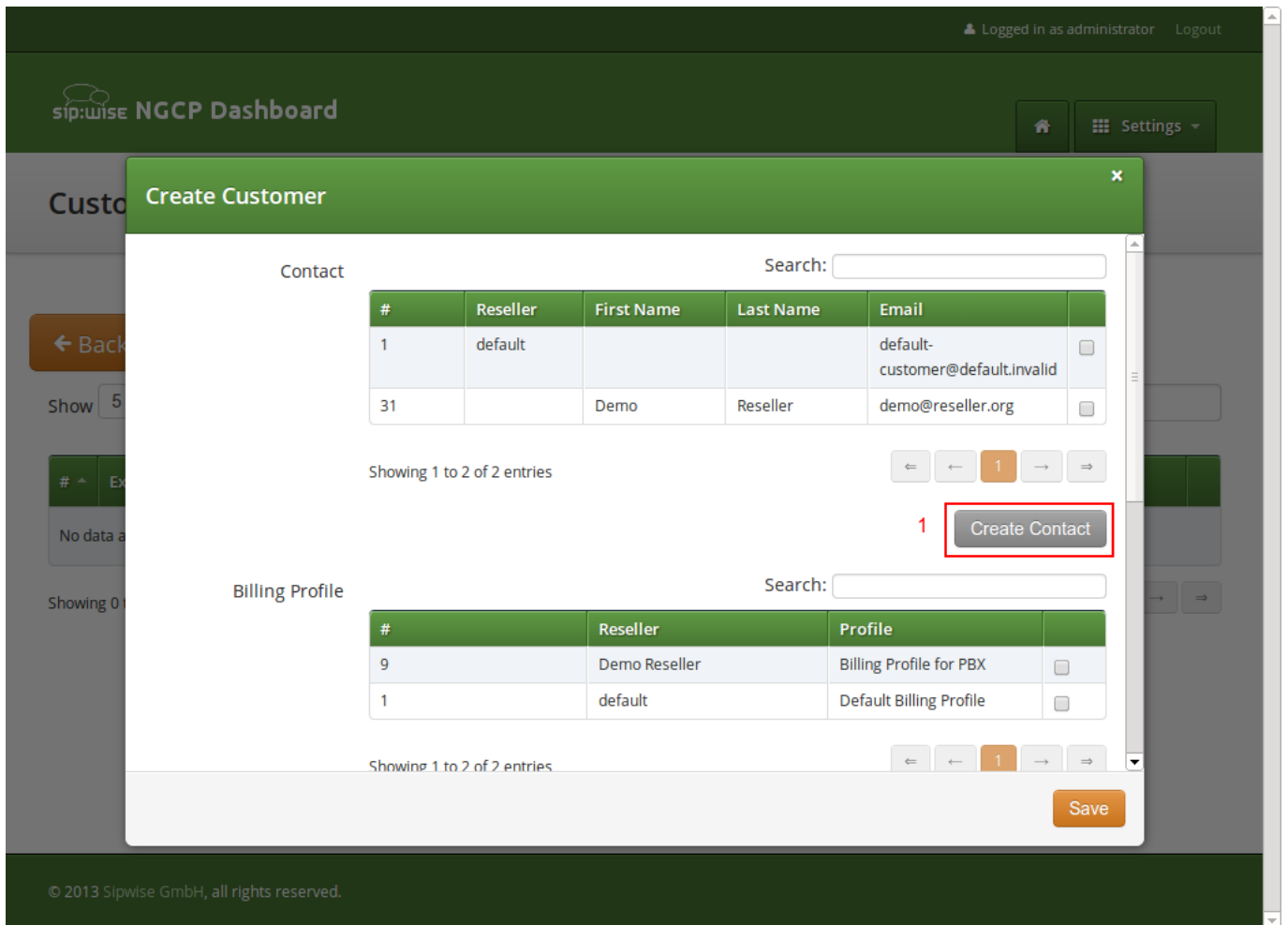

Figure 123: Create PBX Customer Part 1

Fill in the desired fields (you need to provide at least the *Email Address*) and press *Save*.

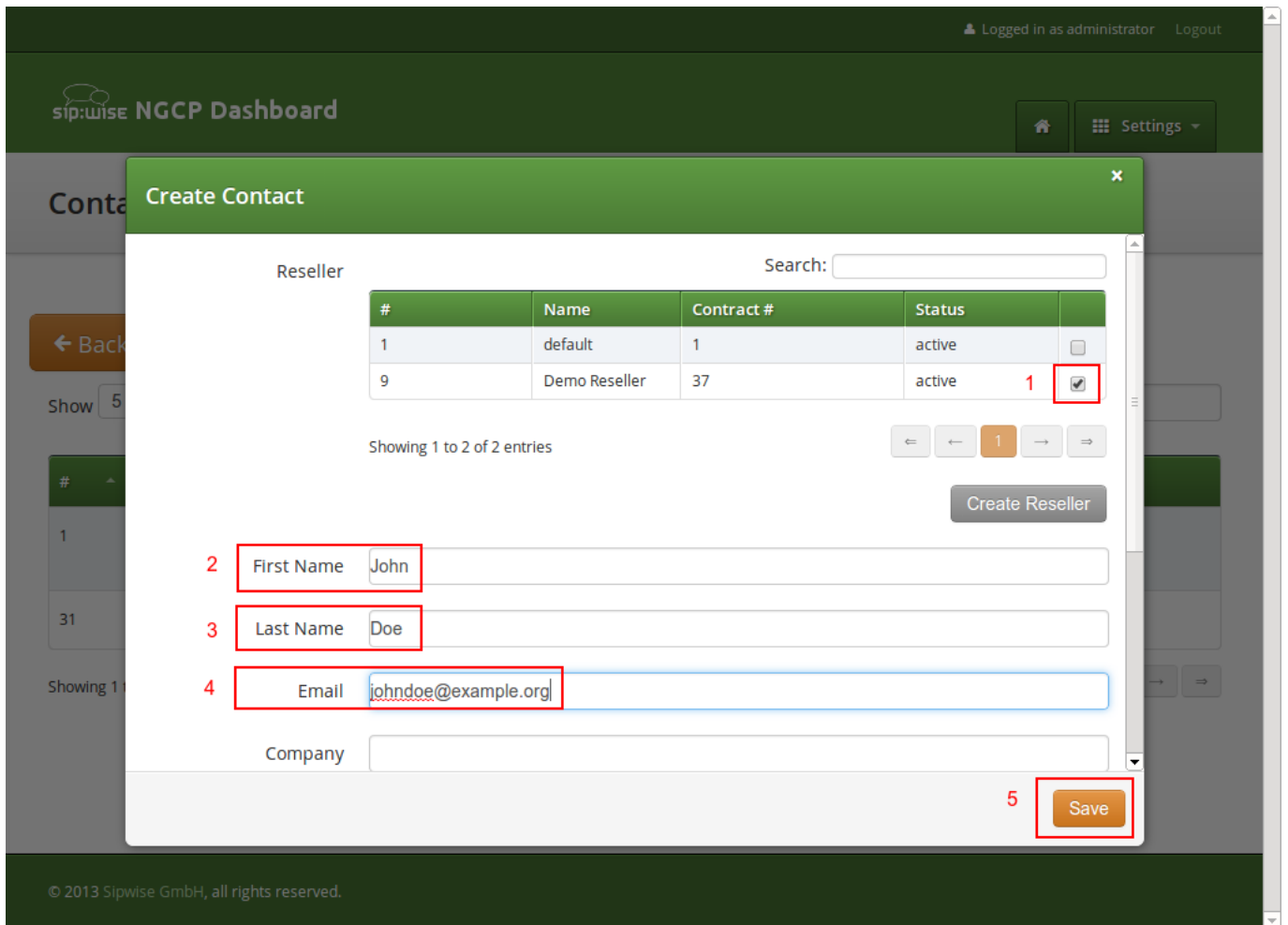

Figure 124: Create PBX Customer Contact

The new *Contact* will be automatically selected now. Also select a *Billing Profile* you want to use for this customer. If you don't have one defined yet, press *Create Billing Profile*, otherwise select the one you want to use.

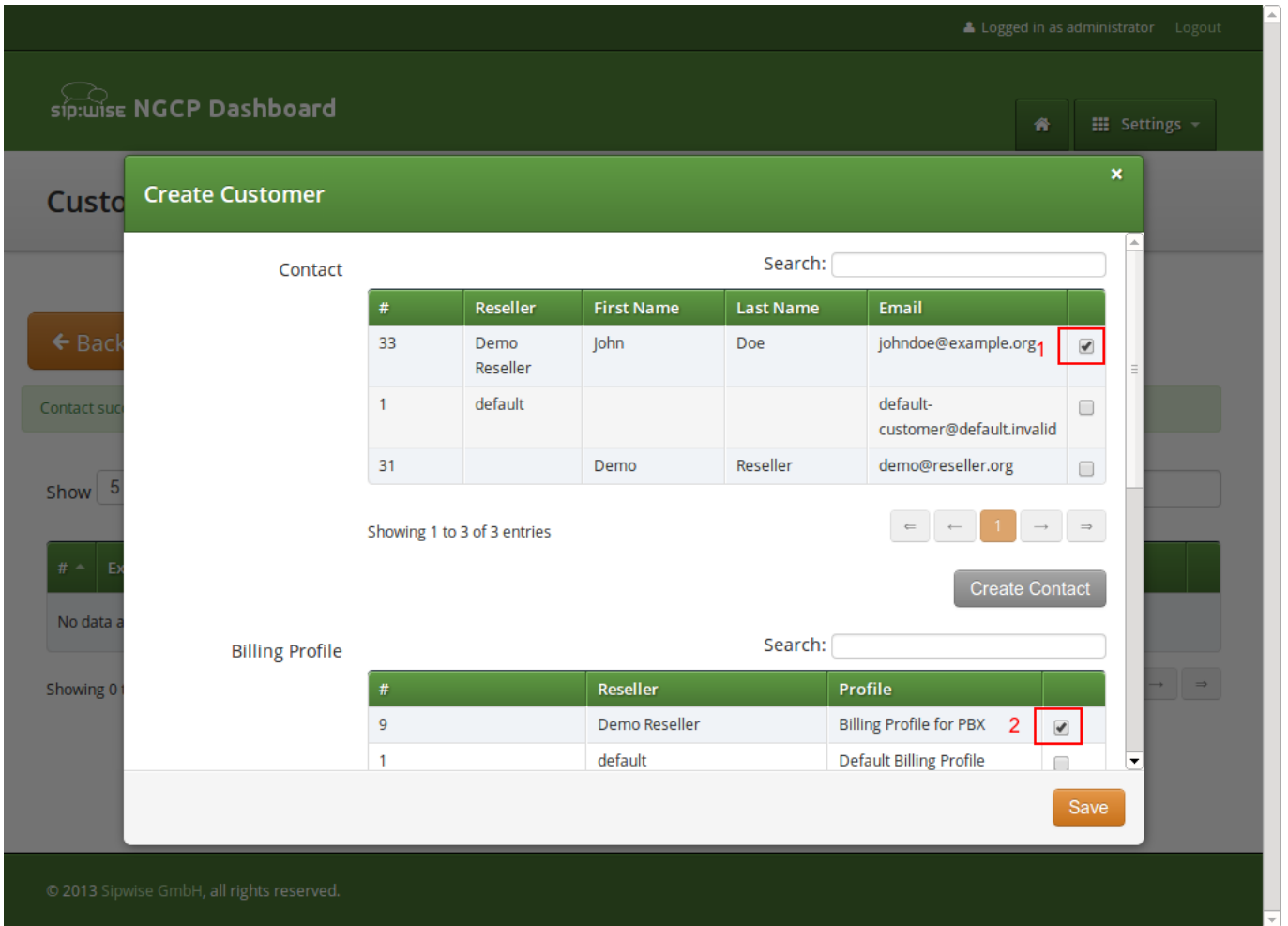

Figure 125: Create PBX Customer Part 2

Next, you need to select the *Product* for the PBX customer. Since it's going to be a PBX customer, select the product *Cloud PBX Account*.

Since PBX customers are supposed to manage their subscribers by themselves, they are able to create them via the web interface. To set an upper limit of subscribers a customer can create, define the value in the *Max Subscribers* field.



Important

As you will see later, both PBX subscribers and PBX groups are normal subscribers, so the value defined here limits the overall amount of subscribers **and** groups. A customer can create an unlimited amount of subscribers if you leave this field empty.

Press *Save* to create the customer.

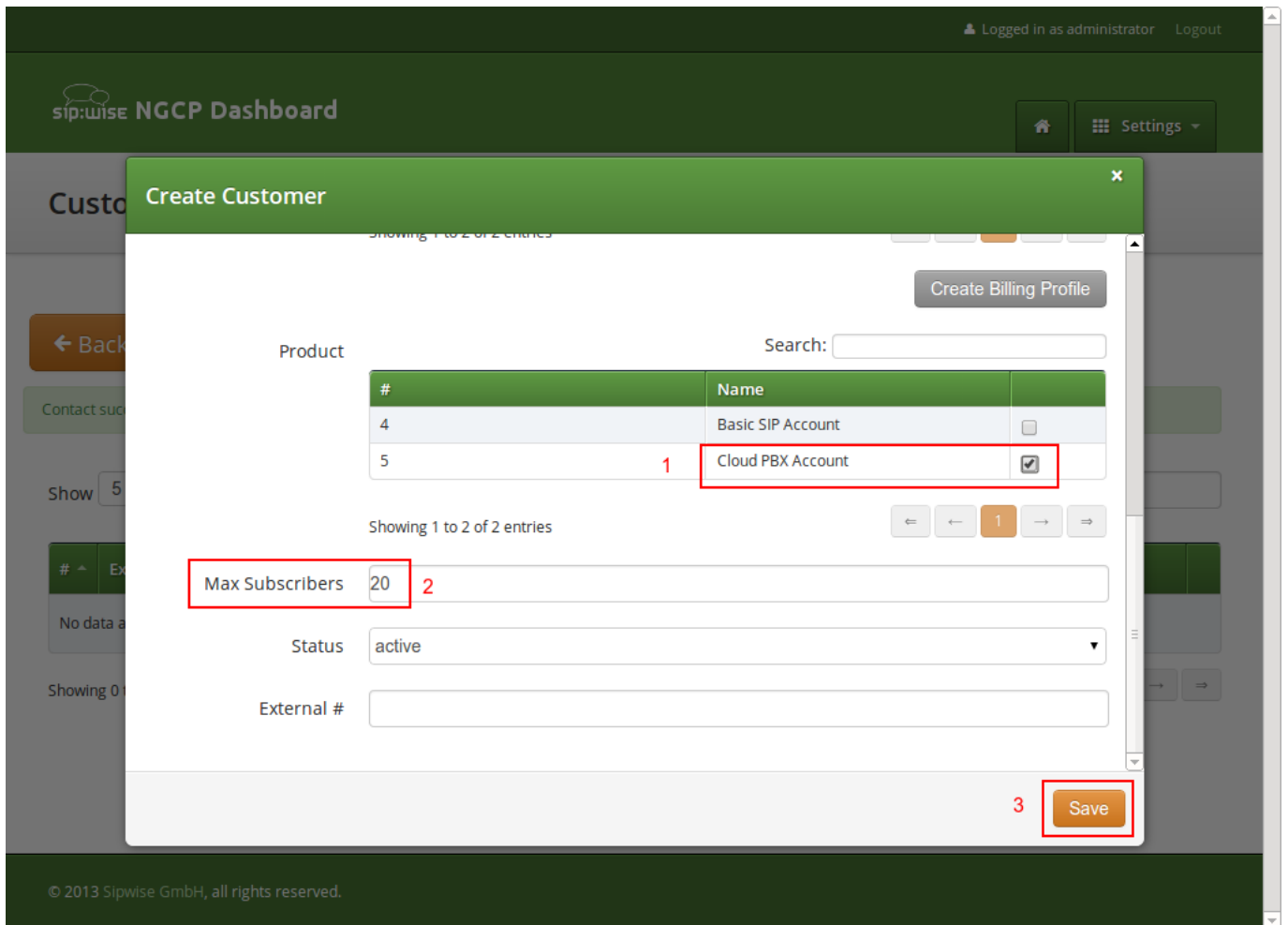

Figure 126: Create PBX Customer Part 3

18.1.3.2 Creating a PBX Pilot Subscriber

Once the customer is created, you need to create at least one *Subscriber* for the customer, so he can log into the web interface and manage the rest by himself.

Click the *Details* button on the newly created customer to enter the detailed view.

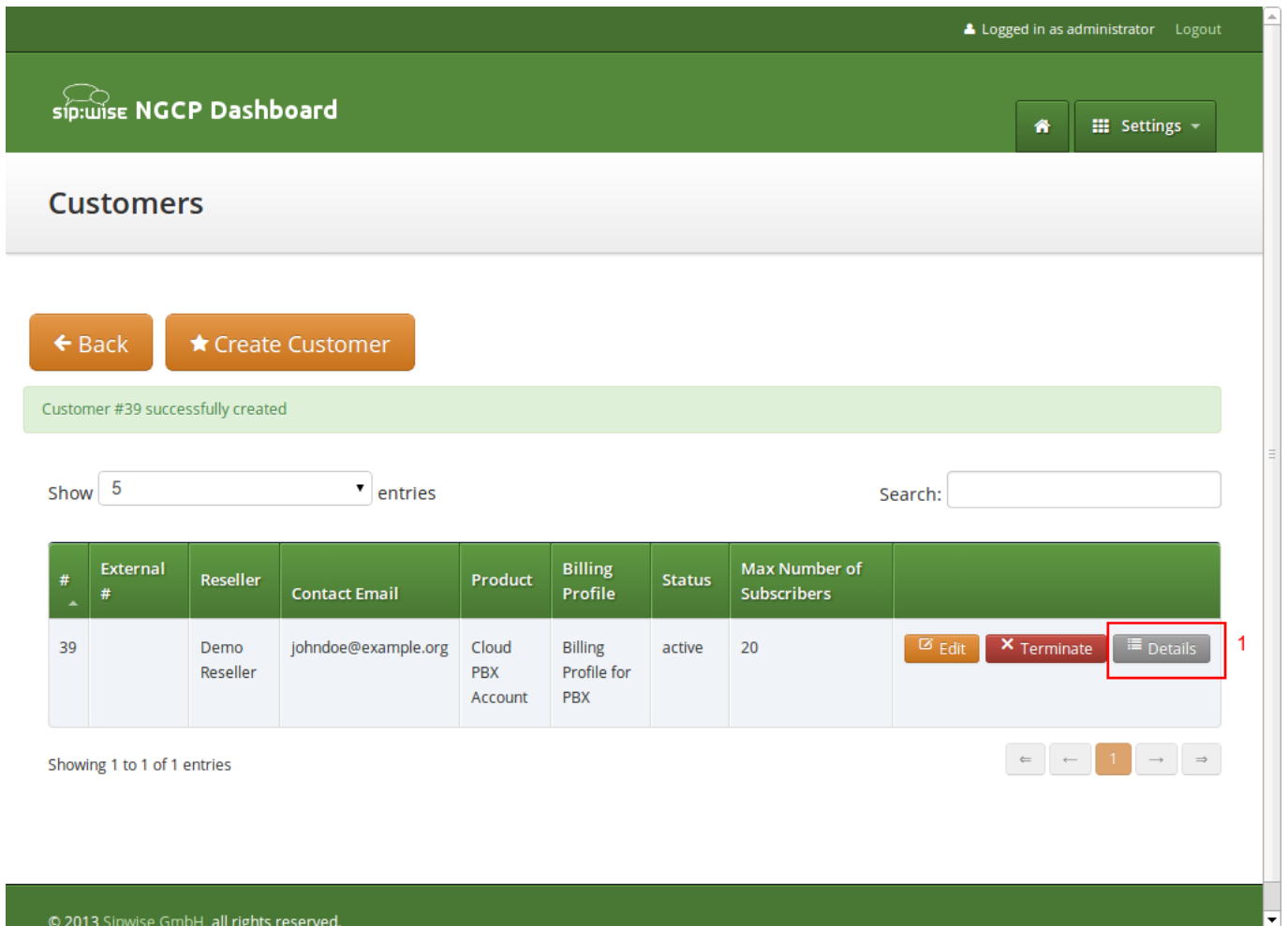

Figure 127: Go to Customer Details

To create the subscriber, open the *Subscribers* row and click *Create Subscriber*.

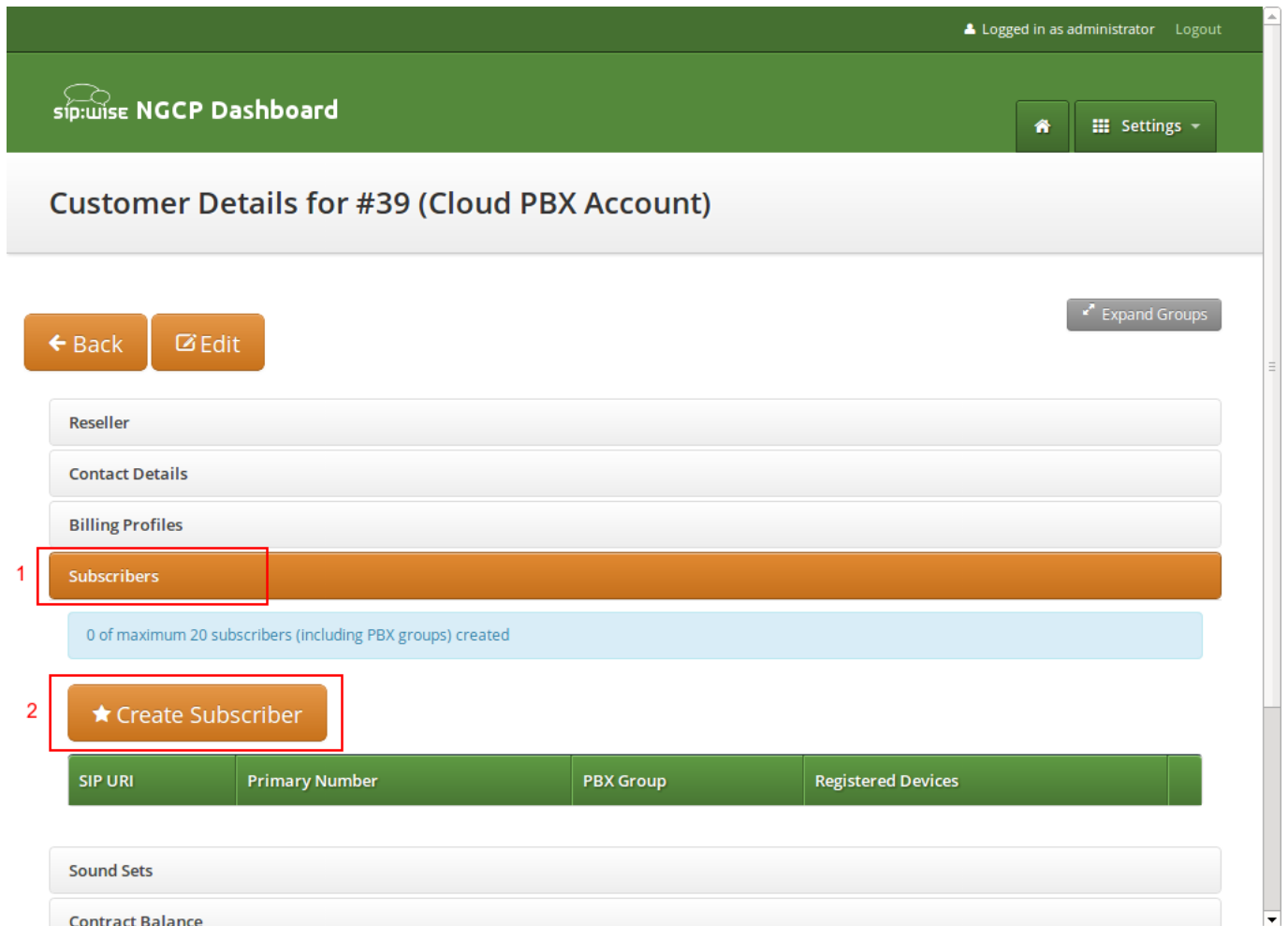

Figure 128: Go to Create Subscriber

For your pilot subscriber, you need a SIP domain, a pilot number (the main number of the customer PBX), the web credentials for the customer to log into the web interfaces, and the SIP credentials to authenticate via a SIP device.

Important



In a PBX environment, customers can create their own subscribers. As a consequence, each PBX customer should have its own SIP domain, in order to not collide with subscribers created by other customers. This is important because two customers are highly likely to create a subscriber (or group, which is also just a subscriber) called *office*. If they are in the same SIP domain, they'd both have the SIP URI *office@pbx.example.org*, which is not allowed, and the an end customer will probably not understand why *office@pbx.example.org* is already taken, because he (for obvious reasons, as it belongs to a different customer) will not see this subscriber in his subscribers list.

Tip

To handle one domain per customer, you should create a wild-card entry into your DNS server like `*.pbx.example.org`, which points to the IP address of `pbx.example.org`, so you can define SIP domains like `customer1.pbx.example.org` or `customer2.pbx.example.org` without having to create a new DNS entry for each of them. For proper secure access to the web interface and to the SIP and XMPP services, you should also obtain a SSL wild-card certificate for `*.pbx.example.org` to avoid certification warnings on customers' web browsers and SIP/XMPP clients.

So to create a new domain for the customer, click *Create Domain*.

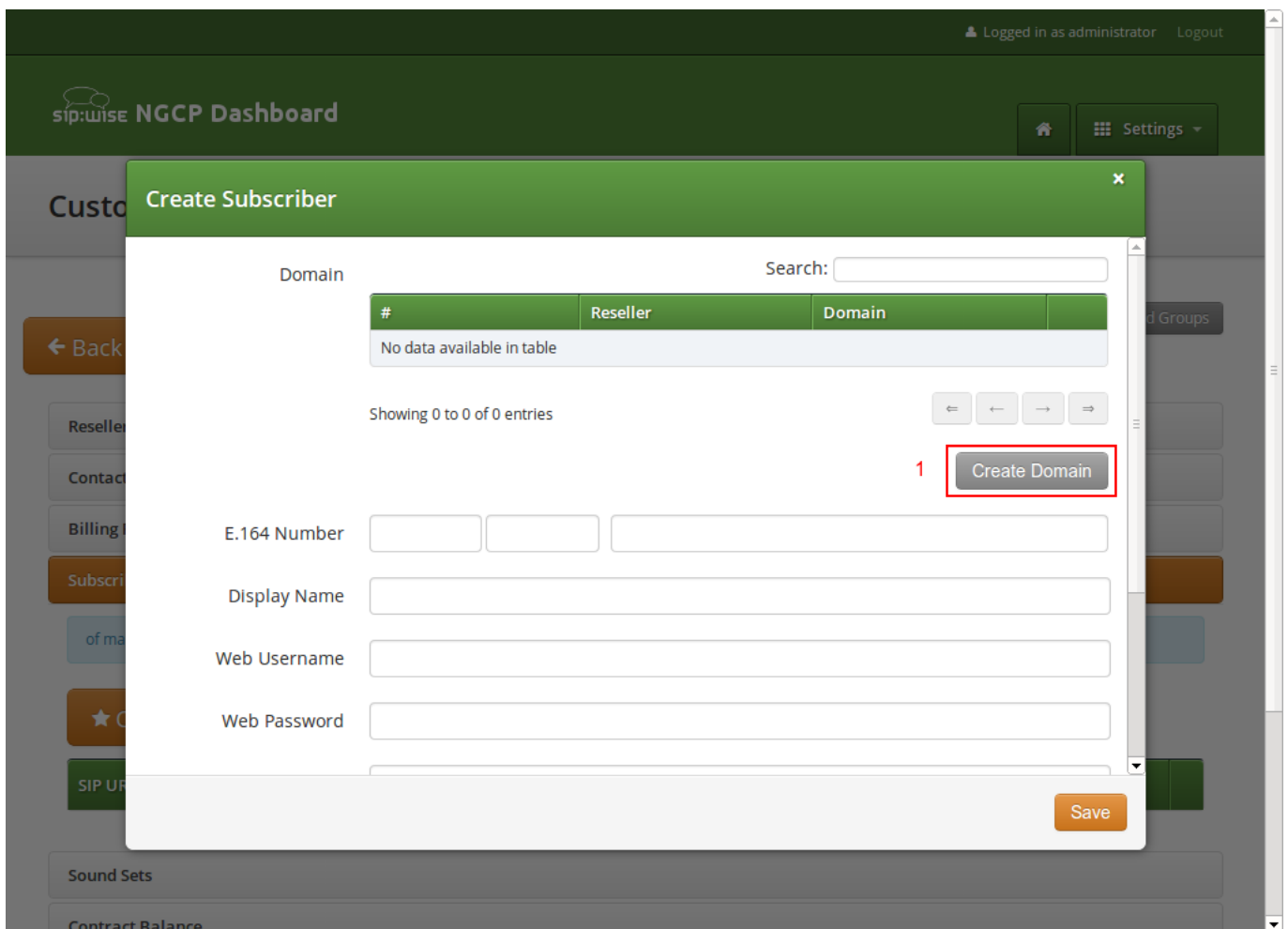

Figure 129: Go to Create Customer Domain

Specify the domain you want to create, and select the PBX *Rewrite Rule Set* which you created in Section 18.1.2, then click *Save*.

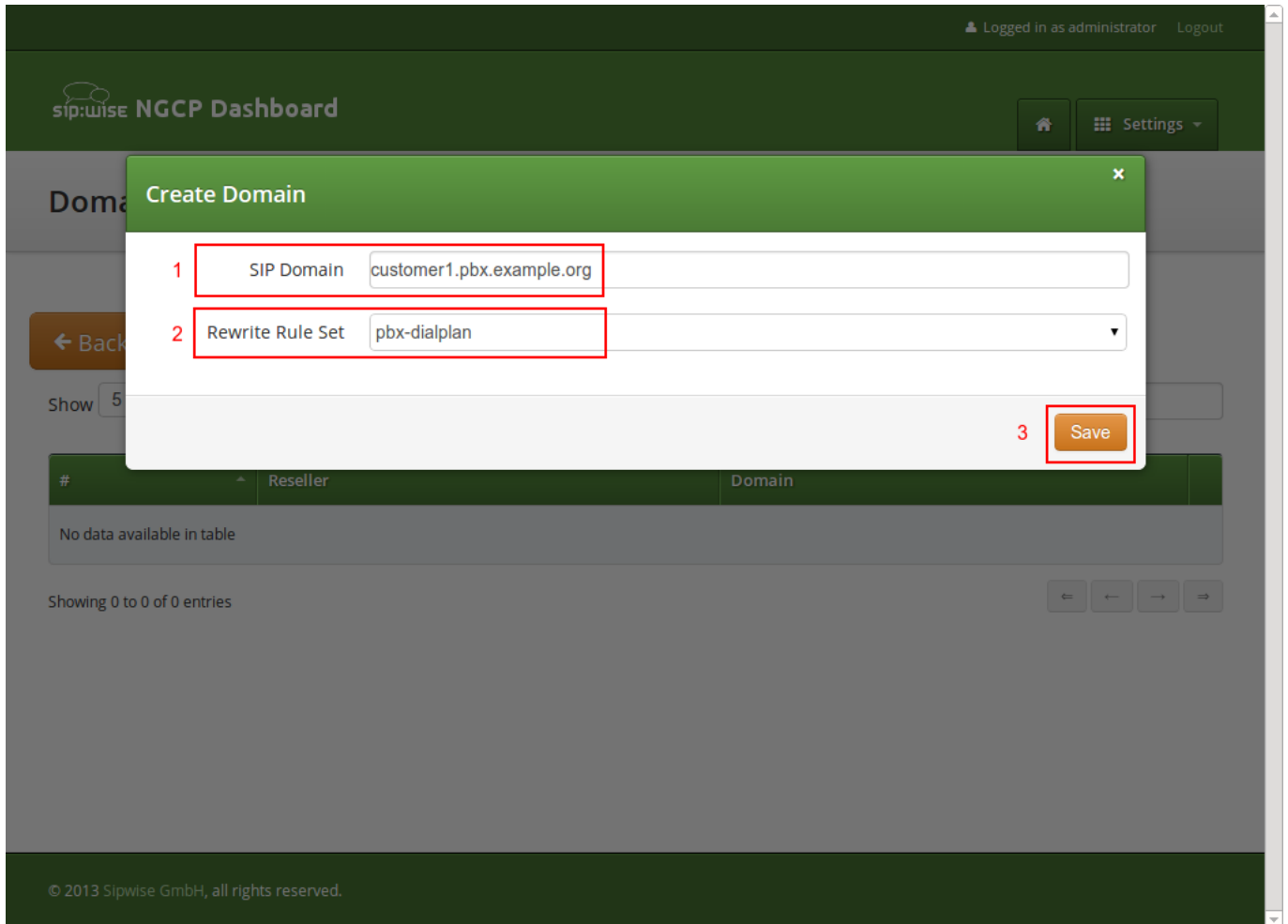

Figure 130: Create Customer Domain

Finish the subscriber creation by providing an E.164 number, which is going to be the base number for all other subscribers within this customer, the web username and password for the pilot subscriber to log into the web interface, and the sip username and password for a SIP device to connect to the PBX.

The parameters are as follows:

- **Domain:** The domain in which to create the pilot subscriber. *Each customer should get his own domain as described above to not collide with SIP usernames between customers.*
- **E.164 Number:** The primary number of the PBX. Calls to this number are routed to the pilot subscriber, and each subsequent subscriber created for this customer will use this number as its base number, suffixed by an individual extension. You can later assign alias numbers also for DID support.
- **Display Name:** This field is used on phones to identify subscribers by their real names instead of their number or extension. On outbound calls, the display name is signalled in the Display-Field of the From header, and it's used as a name in the XMPP contact lists.
- **Web Username:** The username for the subscriber to log into the customer self-care web interface. This is optional, if you don't

want a subscriber to have access to the web interface.

- **Web Password:** The password for the subscriber to log into the customer self-care web interface.
- **SIP Username:** The username for the subscriber to authenticate on the SIP and XMPP service. It is automatically used for devices, which are auto-provisioned via the *Device Management*, or can be used manually by subscribers to sign into the SIP and XMPP service with any arbitrary clients.
- **SIP Password:** The password for the subscriber to authenticate on the SIP and XMPP service.

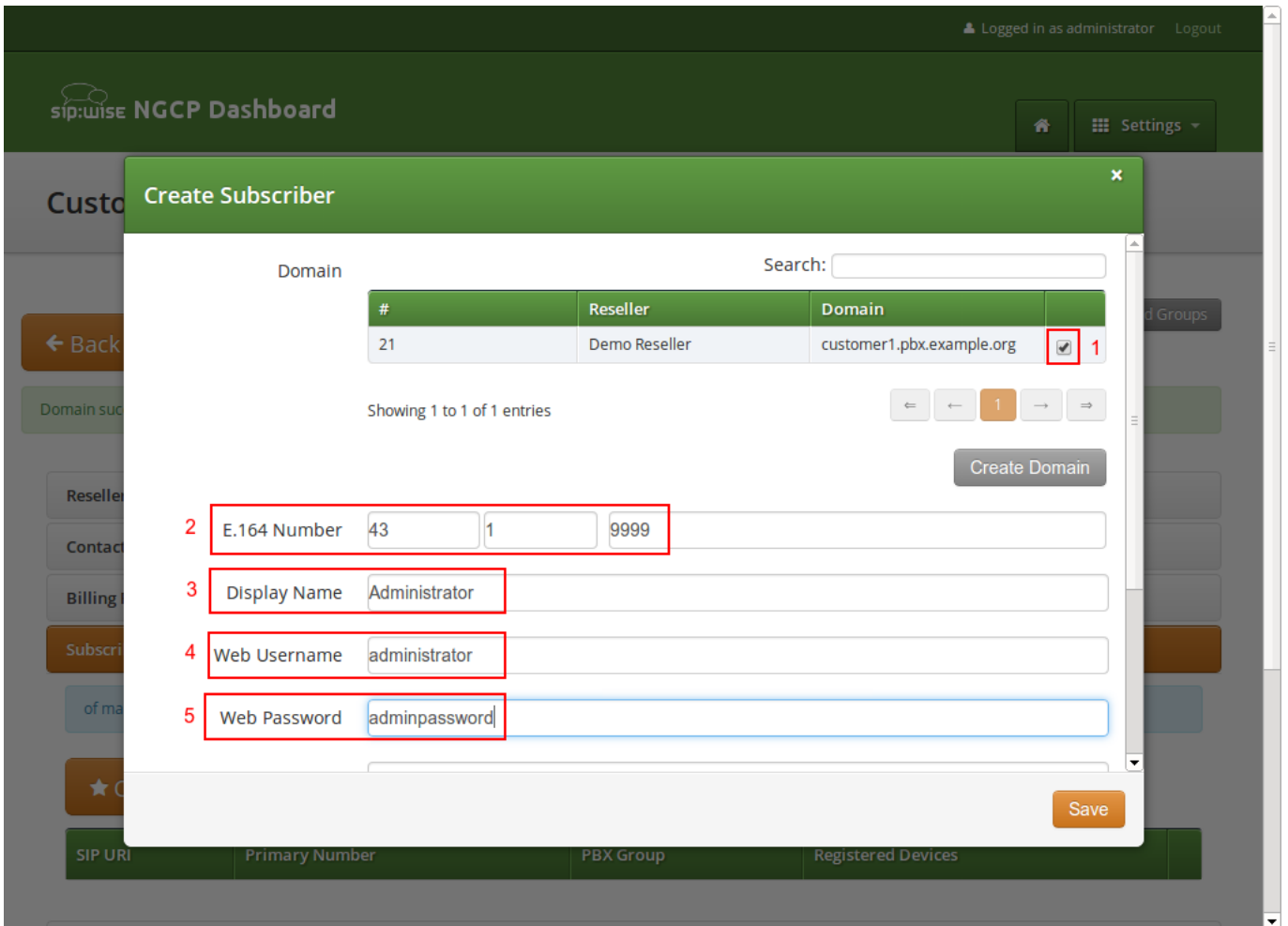

Figure 131: Create Pilot Subscriber Part 1

Customer Details for #39 (Cloud PBX Account)

← Back

Domain sub

Reseller

Contact

Billing

Subscriber

of ma

★ C

SIP UP

Sound S

Contract Balance

Fraud Limits

Groups

Create Subscriber

E.164 Number

Display Name

Web Username

Web Password

1 SIP Username

2 SIP Password

Status

External ID

3 Save

Figure 132: Create Pilot Subscriber Part 2

Once the subscriber is created, he can log into the customer self-care interface at <https://<your-ip>/login/subscriber> and manage his PBX, like creating other users and groups, assigning Devices to subscribers and configure the Auto Attendant and more.

As an administrator, you can also do this for the customer, and we will walk through the typical steps as an administrator to configure the different features.

Go to the *Customer Details* of the PBX customer you want to configure, e.g. by navigating to *Settings*→*Customers* and clicking the *Details* button of the customer you want to configure.

18.1.4 Creating Regular PBX Subscribers

Since we already created a pilot subscriber, more settings now appear on the *Customer Details* view. The sections we are interested in for now are the *Subscribers* and *PBX Groups* sections.

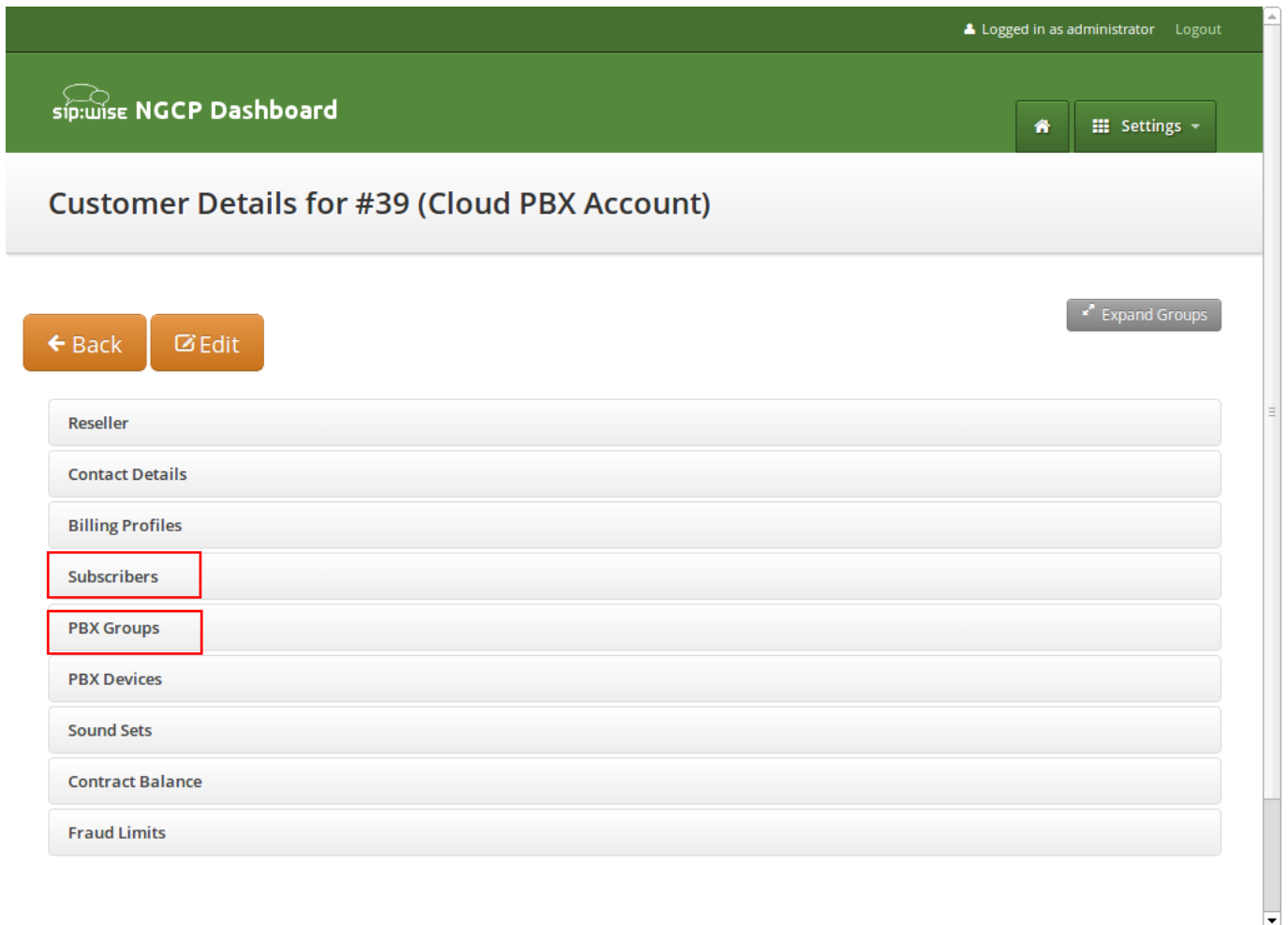
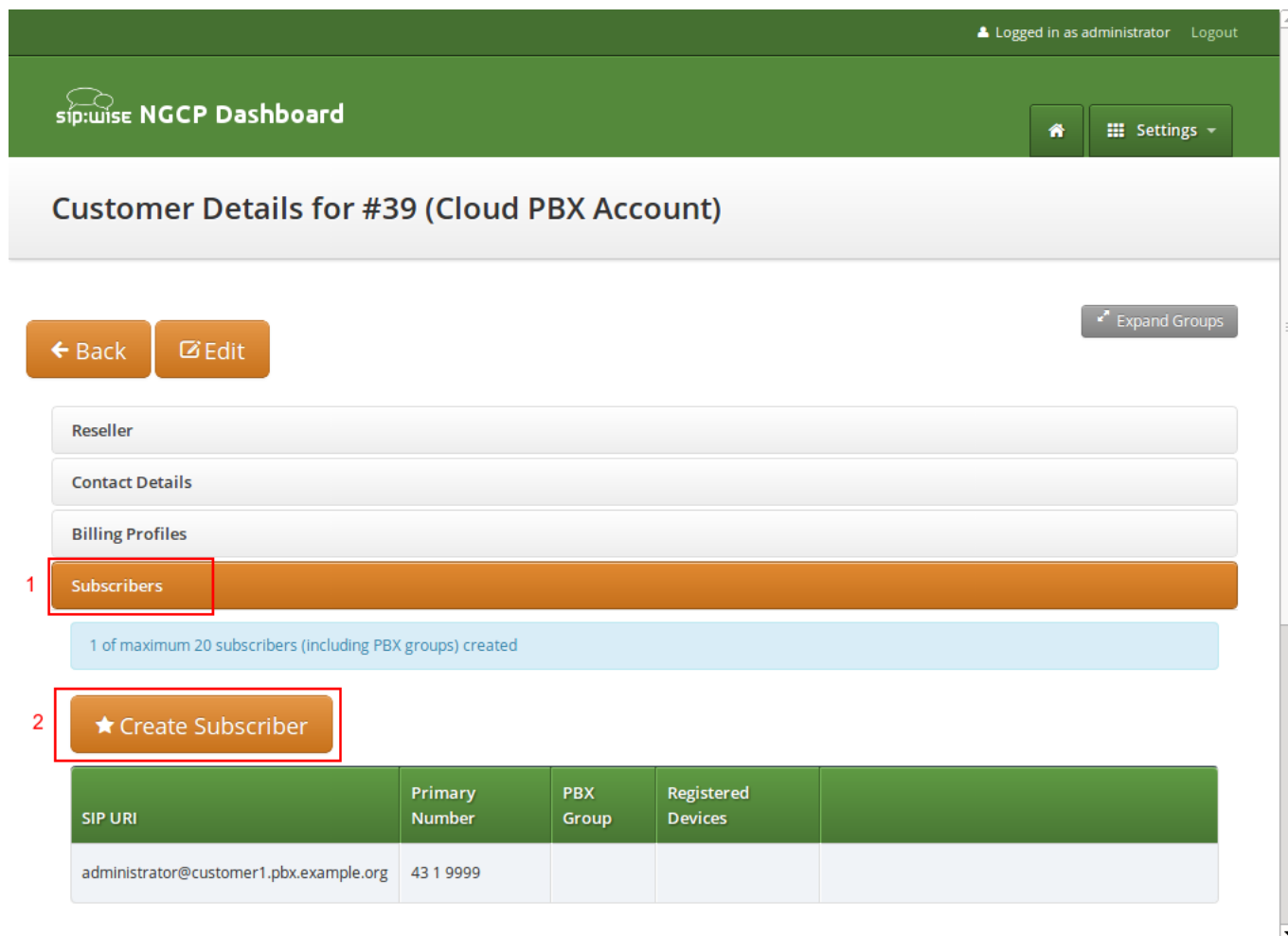

Figure 133: Subscribers and PBX Groups

To create another subscriber for the customer PBX, open the *Subscribers* row and click *Create Subscriber*.



Customer Details for #39 (Cloud PBX Account)

← Back Edit Expand Groups

Reseller

Contact Details

Billing Profiles

1 Subscribers

1 of maximum 20 subscribers (including PBX groups) created

2 ★ Create Subscriber

SIP URI	Primary Number	PBX Group	Registered Devices
administrator@customer1.pbx.example.org	43 1 9999		

Figure 134: Create a Subscriber Extension

When creating another subscriber in the PBX after having the pilot subscriber, some fields are different now, because the *Domain* and *E.164 Number* are already pre-defined at the pilot subscriber level.

What you need to define for a new subscriber is the *Group* the subscriber is supposed to be in. We don't have a group yet, so create one by clicking *Create Group*.

A *PBX Group* has four settings:

- **Name:** The name of the group. This is used to identify a group when assigning it to subscribers on one hand, and also subscribers are pushed as server side contact lists to XMPP clients, where they are logically placed into their corresponding groups.
- **Extension:** The extension of the group, which is appended to the primary number of the pilot subscriber, so you can actually call the group from the outside. If our pilot subscriber number is 43 1 9999 and the extension is 100, you can reach the group from the outside by dialing 43 1 9999 100. Since PBX Groups are actually just normal subscribers in the system, you can assign *Alias Numbers* to it for DID later, e.g. 43 1 9998.
- **Hunting Policy:** If you call a group, then all members in this group are ringing based on the policy you choose. *Serial*

Ringling causes each of the subscribers to be tried one after another, until one of them picks up or all subscribers are tried. Parallel Ringing causes all subscribers in the group to be tried in parallel. Note that a subscriber can have a call-forward configured to some external number (e.g. his mobile phone), which will work as well.

- **Serial Hunting Timeout:** This value defines for how long to ring each member of a group in case of serial hunting until the next subscriber is being tried.

We will only fill in the *Name* and *Extension* for now, as the hunting policy can be changed later if needed. Click *Save* to create the group.

The screenshot shows the 'Create PBX Group' modal in the sip:wise NGCP Dashboard. The form contains the following fields:

- Name:** marketing (highlighted with a red box and labeled '1')
- Extension:** 100 (highlighted with a red box and labeled '2')
- Hunting Policy:** Serial Ringing (dropdown menu)
- Serial Hunting Timeout:** 10
- Save:** A button at the bottom right (highlighted with a red box and labeled '3')

Below the modal, there is a table with the following data:

SIP URI	Primary Number	PBX Group	Registered Devices
administrator@customer1.pbx.example.org	43 1 9999		

Figure 135: Create a PBX Group

Once the group is created and selected, fill out the rest of the form as needed. Instead of the *E.164 Number*, you can now only choose the *Extension*, which is appended to the primary number of the pilot subscriber and is then used as primary number for this particular subscribers. Again, if your pilot number is 43 1 9999 and you choose extension 101 here, the number of this subscriber is going to be 43 1 9999 101. Also, you can again later assign more alias numbers (e.g. 43 1 9997) to this subscriber for DID.

The rest of the fields is as usual, with *Display Name* defining the real name of the user, *Web Username* and *Web Password* allowing the subscriber to log into the customer self-care interface, and the *SIP Username* and *SIP Password* to allow signing into

the SIP and XMPP services.

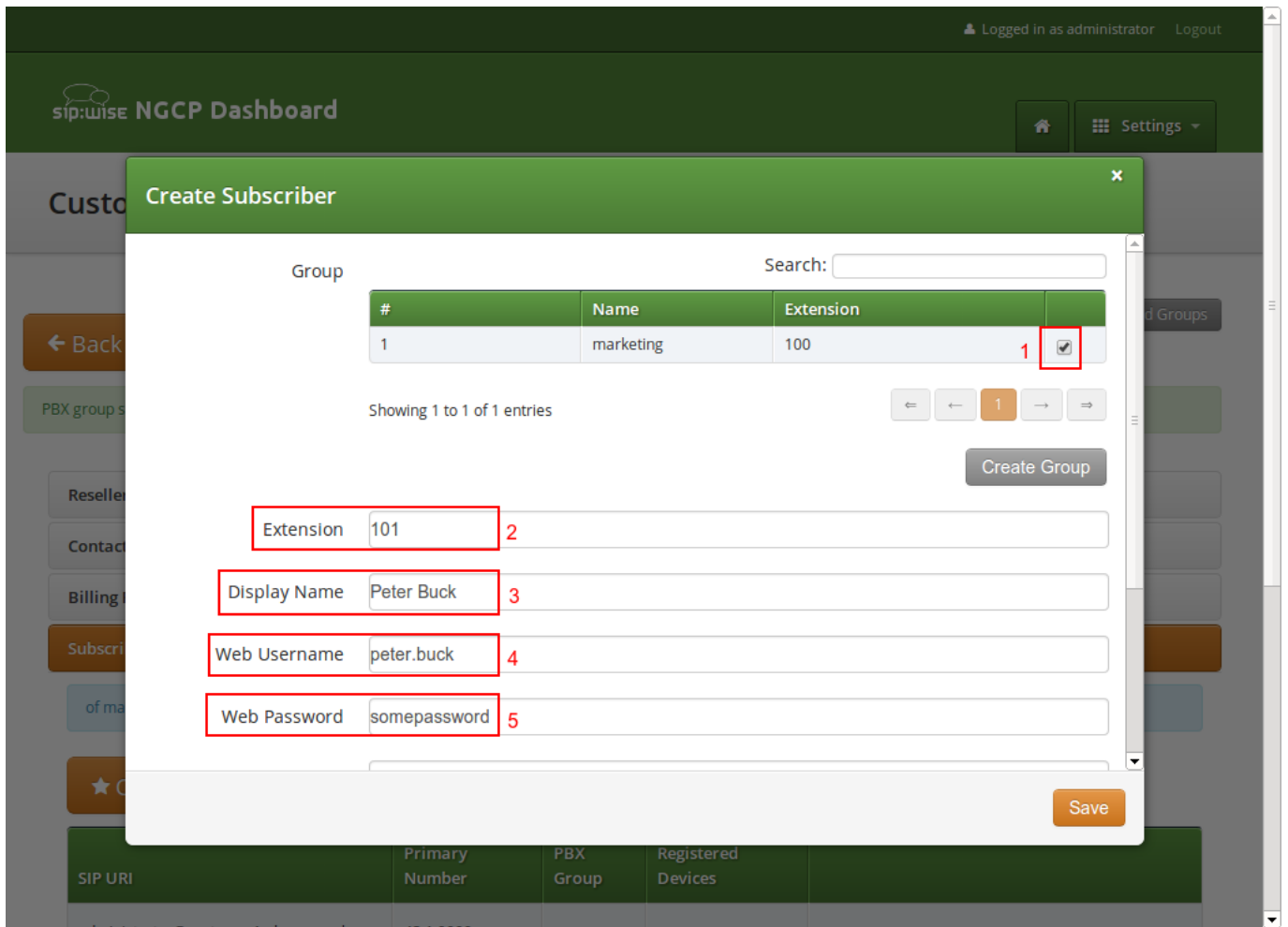

Figure 136: Finish PBX Subscriber Creation Part 1

Click Save to create the subscriber.

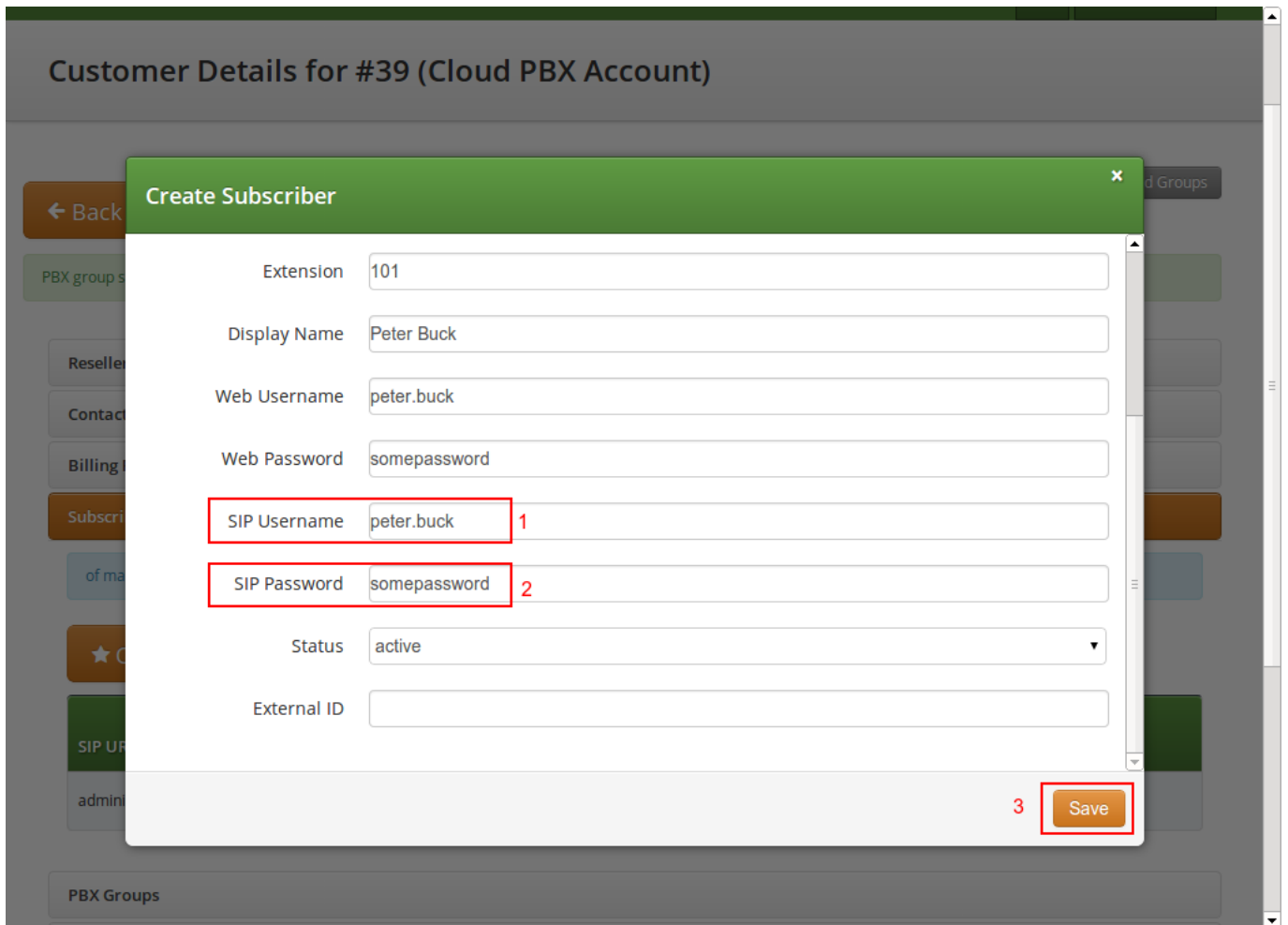

Figure 137: Finish PBX Subscriber Creation Part 2

Repeat the steps to create all the subscribers and groups as needed. An example of a small company configuration in terms of subscribers and groups might look like this:

Reseller

Contact Details

Billing Profiles

Subscribers

7 of maximum 20 subscribers (including PBX groups) created

★ Create Subscriber

SIP URI	Primary Number	PBX Group	Registered Devices
administrator@customer1.pbx.example.org	43 1 9999		
peter.buck@customer1.pbx.example.org	43 1 9999101	marketing	
michelle.miller@customer1.pbx.example.org	43 1 9999102	marketing	
frank.fowler@customer1.pbx.example.org	43 1 9999201	development	
deborah.dane@customer1.pbx.example.org	43 1 9999202	development	

PBX Groups

PBX Devices

Sound Sets

Figure 138: Example of Subscribers List

Tip

The subscribers can be reached via 3 different ways. First, you can call them by their SIP URIs (e.g. by dialing `frank.fowler@customer1.pbx.example.org`) from both inside and outside the PBX. Second, you can dial by the full number (e.g. `43 1 9999 201`; depending on your rewrite rules, you might need to add a leading `\+` or `00` or leave out the country code when dialing from the outside, and adding a `0` as break-out digit when dialing from the inside) from both inside and outside the PBX. Third, you can dial just the extension (e.g. `201`) from inside the PBX. If the subscriber also has an alias number assigned, you can dial that number also, according to your dial-plan in the rewrite rules.

18.1.5 Assigning Subscribers to a Device

Basically, you can register any SIP phone with the system using a SIP subscriber credentials. However, the platform supports *PBX Device Provisioning* of certain vendors and models, as described in Section 18.1.1.

To configure a physical device, expand the *PBX Devices* section in the *Customer Details* page and click *Create Device*.

Set up three general parameters for the new device, which are:

- **Device Profile:** The actual device profile you want to use. This has been pre-configured in the *Device Management* by the administrator or reseller, and the customer can choose from the list of profiles (which is a combination of an actual device plus its corresponding configuration).
- **MAC Address/Identifier:** The MAC address of the phone to be added. The information can usually either be found on the back of the phone, or in the phone menu itself.
- **Station Name:** Since you can (depending on the actual device) configure more lines on a phone, you can give it a station name, like *Reception* or the name of the owner of the device.

In addition to that information, you can configure the lines (subscribers) you want to use on which key, and the mode of operation (e.g. if it's a normal private phone line, or if you want to monitor another subscriber using BLF, or if you want it to act as shared line using SLA).

For example, a *Cisco SPA504G* has 4 keys you can use for private and shared lines as well as BLF on the phone itself, and in our example we have an *Attendant Console* attached to it as well, so you have 32 more keys for BLF.

The settings per key are as follows:

- **Subscriber:** The subscriber to use (for private/shared lines) or to monitor (for BLF).
- **Line/Key:** The key where to configure this subscriber to.
- **Line/Key Type:** The mode of operation for this key, with the following options (depending on which options are enabled in the *Device Model* configuration for this device):
 - **Private Line:** Use the subscriber as a regular SIP phone line. This means that the phone will register the subscriber, and you can place and receive phone calls with/for this subscriber.
 - **Shared Line:** The subscriber is also registered on the system and you can place and receive calls. If another phone has the same subscriber also configured as shared line, both phones will ring on incoming calls, and you can pick the call up on either of them. You cannot place a call with this subscriber though if the line is already in use by another subscriber. However, you can "steal" a running call by pressing the key where the shared line is configured to barge into a running call. The other party (the other phone where the shared line is configured too) will then be removed from the call (but can steal the call back the same way).
 - **BLF Key:** The *Busy Lamp Field* monitors the call state of another subscriber and provides three different functionalities, depending on the actual state:
 - * **Speed Dial:** If the monitored subscriber is on-hook, the user can press the button and directly call the monitored subscriber.
 - * **Call Pickup:** If the monitored subscriber is ringing, the user can press the button to pick up the call on his own phone.
 - * **State Indication:** If the monitored subscriber is on the phone, the key is indicating that the monitored subscriber is currently busy.

In our example, we will configure a private line on the first key, and the BLF for another subscriber on the second key.

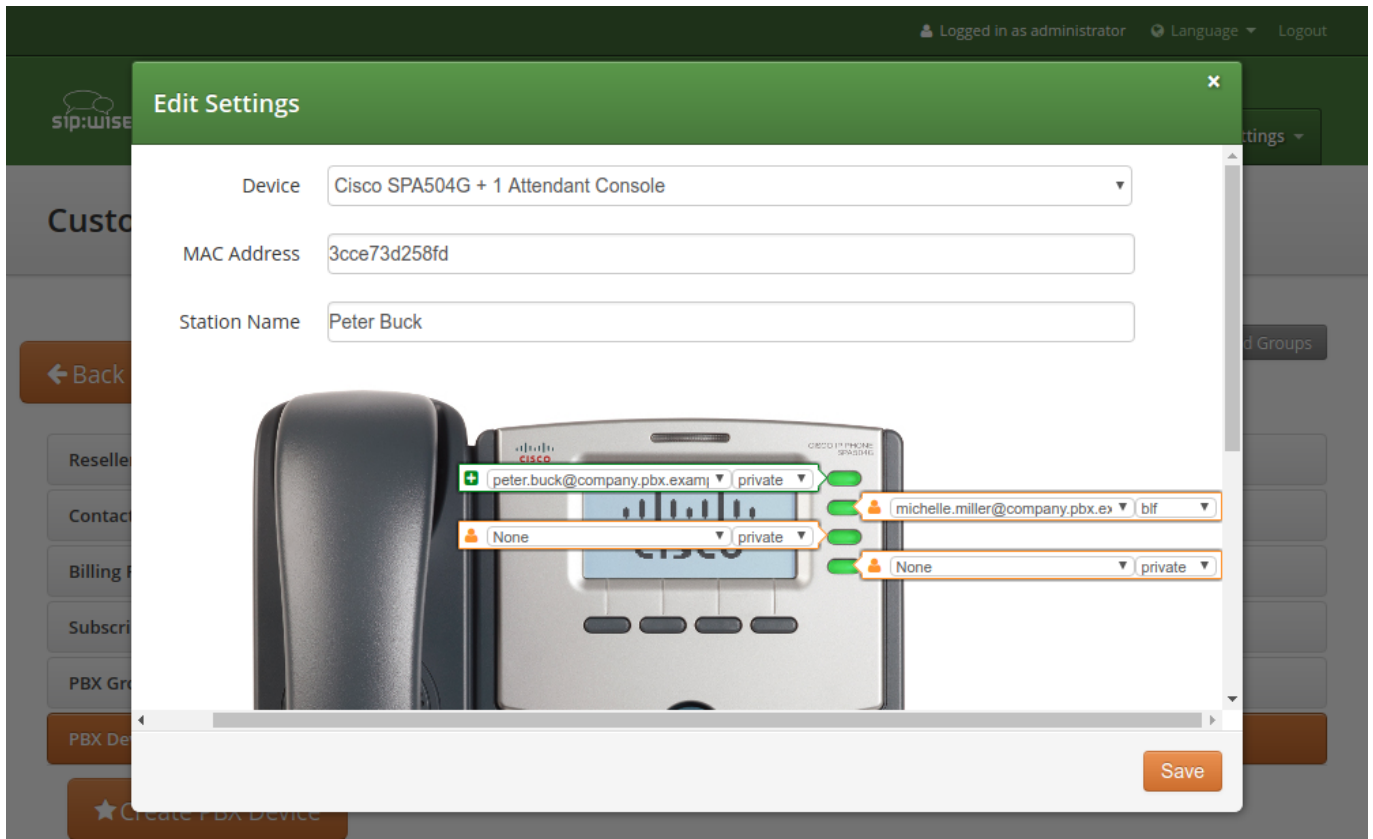

Figure 139: Configuring a PBX Device

Once the PBX device is saved, you will see it in the list of *PBX Devices*.

18.1.5.1 Initial provisioning of a PBX Device

Depending on a manufacturer and the model, there are two ways of provisioning a device:

- putting the provisioning URL directly to the device via a web browser (this option is used e.g. for Cisco devices);
- using the device's Zero Touch Provisioning (ZTP) feature. For Yealink it is called Redirection and Provisioning Service (RPS).

18.1.5.2 Direct device provisioning

Since a stock device obtained from an arbitrary distributor doesn't know anything about your system, it can't fetch its configuration from there. For that to work, you need to push the URL of where the phone can get the configuration to the phone once.

In order to do so, click the *Sync Device* button on the device you want to configure for the very first time.

Contact Details

Billing Profile Schedule

Subscribers

PBX Groups

PBX Devices

★ Create PBX Device

Station Name	Subscriber	MAC Address / Identifier	Device Profile	
	Peter Buck Phone Keys/0: private peter.buck@company.pbx.example.org Phone Keys/1: blf michelle.miller@company.pbx.example.org	3cce73d258fd	Cisco SPA504G + 1 Attendant Console	✕ Delete ✎ Edit ⚙ Config ✎ Sync Device

Sound Sets

Contract Balance

Balance Intervals

Top up Log

Figure 140: Go to Sync Device



Important

As you will see in the next step, you need the actual IP address of the phone to push the provisioning URL onto it. That implies that you need access to the phone to get the IP, and that your browser is in the same network as the phone in order to be able to connect to it, in case the phone is behind NAT.

Enter the IP Address of the phone (on Cisco SPAs, press *Settings* 9, where *Settings* is the paper sheet symbol, and note down the *Current IP setting*), then click *Push Provisioning URL*.

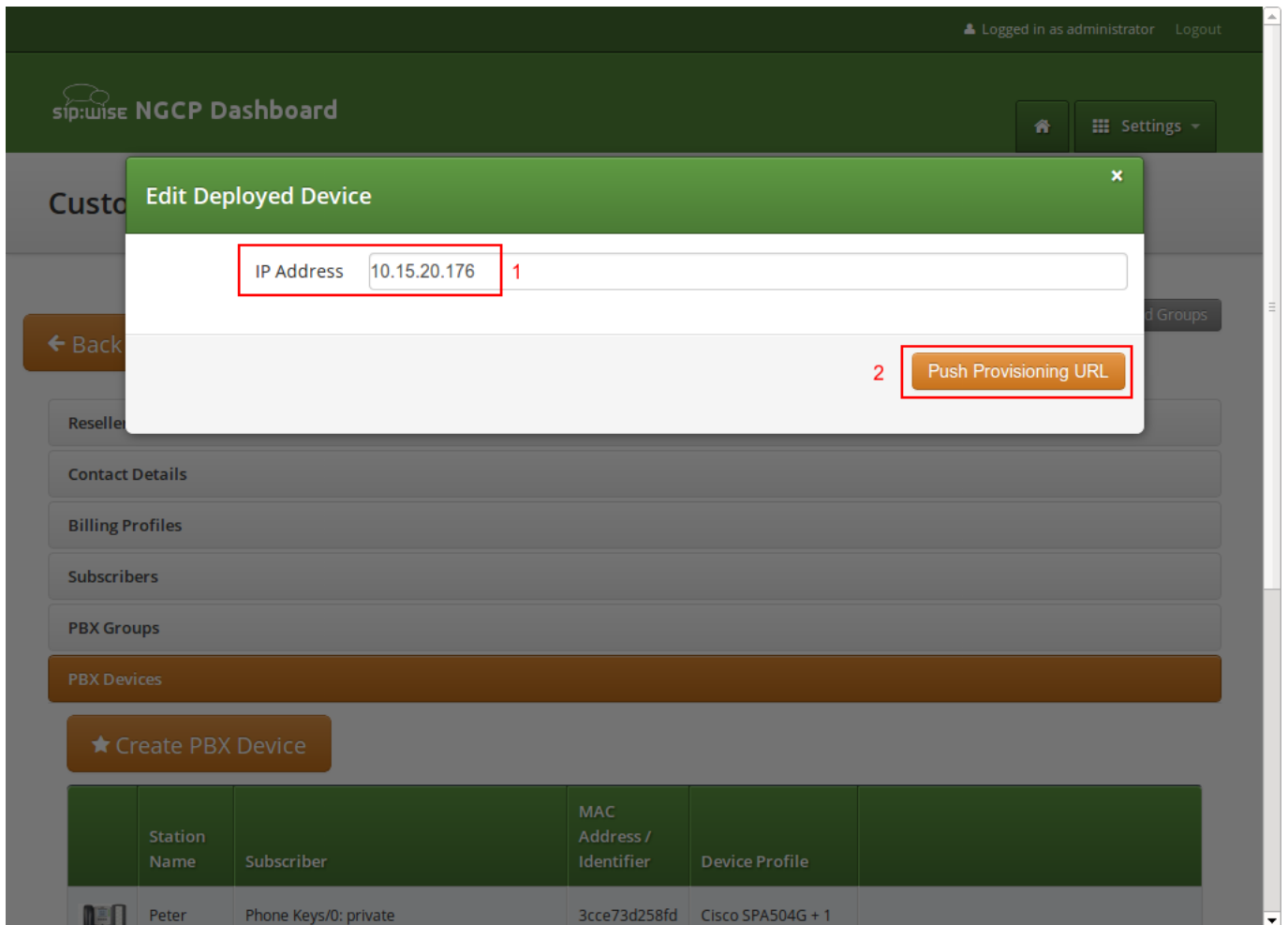



Figure 141: Sync Device

You will be redirected directly to the phone, and the Provisioning URL is automatically set. If everything goes right, you will see a confirmation page from the phone that it's going to reboot.



SPA will resync the profile when it is not in use and reboot.
You can click [here](#) to return to the configuration page.

Figure 142: Device Sync Confirmation from Phone

You can close the browser window/tab and proceed to sync the next subscriber.

Tip

You only have to do this step once per phone to tell it the actual provisioning URL, where it can fetch the configuration from. From there, it will regularly sync with the server automatically to check for configuration changes and apply them automatically.

18.1.5.3 Provisioning a device using ZTP/RPS

All Polycom, Panasonic, Snom, Grandstream and Yealink phones supported by Sipwise C5 can be provisioned using ZTP/RPS service without physically accessing the devices. You only need to input MAC addresses of corresponding devices and associate them with subscribers. Sipwise C5 will then immediately supply this information to the ZTP/RPS system of the corresponding device vendor. When a subscriber unpacks the phone and connects it to the Internet for the first time, the phone will contact the manufacturer's ZTP/RPS service and get its provisioning URL to Sipwise C5. Then, the phone downloads all required items from Sipwise C5 and automatically configures itself. Immediately after that, the subscriber can make the first call.

To prepare a PBX device for ZTP/RPS provisioning, follow these steps:

- Go to the PBX Devices section of the corresponding customer and click *Create PBX Device*.
- Specify the device and its SIP lines parameters:
 - Select the required device model
 - Input the device MAC address
 - Specify the name of this line for your convenience
 - Select a subscriber from the list for the corresponding SIP line. Some devices support multiple lines and you can provision all of them at once.
 - Select the line type: *private*, *shared* or *BLF*.

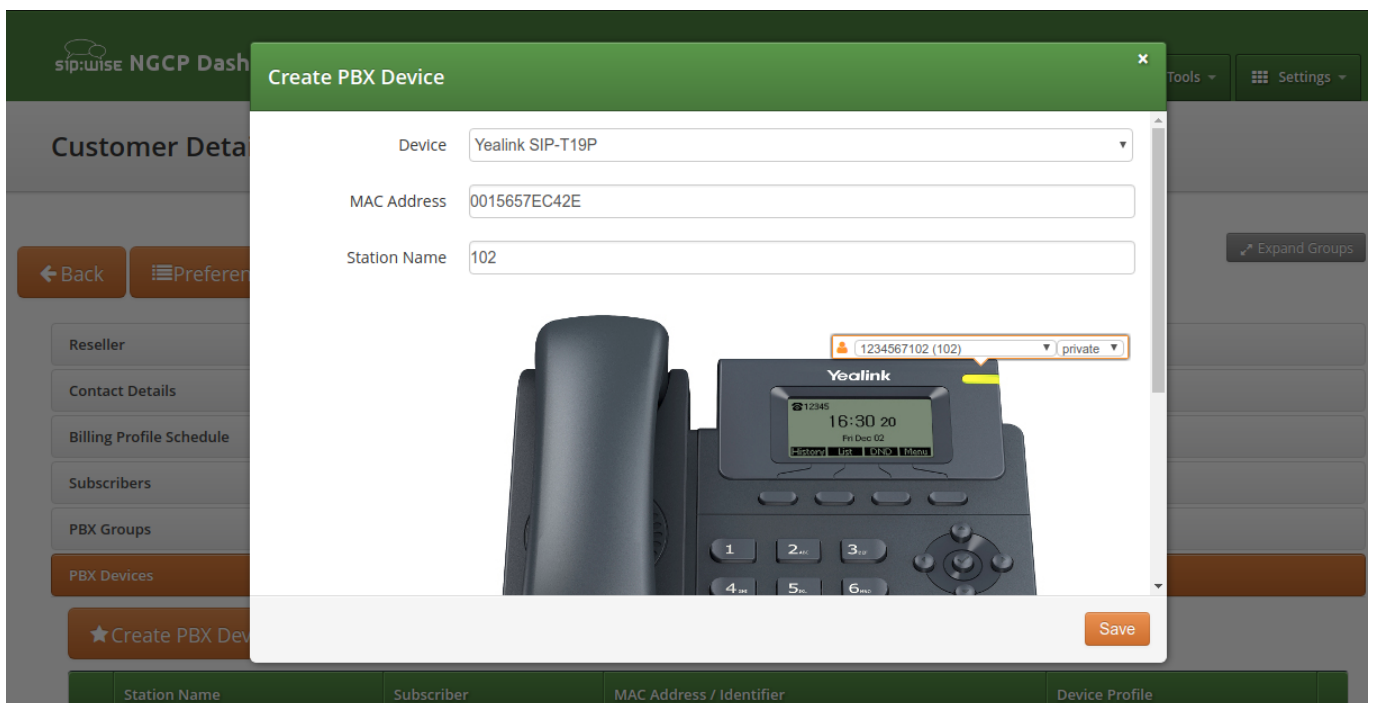

Figure 143: Create a PBX device

- Click *Save*. You will see the device in the list of customer's PBX devices.

PBX Devices					
★ Create PBX Device					
	Station Name	Subscriber	MAC Address / Identifier	Device Profile	
	102	Full Keys/0: private 1234567102@test.mgm.sipwise.com	0015657ec42e	Yealink SIP-T19P	

Figure 144: Created a new PBX device

Tip

If you have already provisioned a specific device on another platform or for another reseller, then you might need to delete that MAC address manually from the ZTP/RPS service.

When the PBX device provisions itself, it will become registered with your SIP proxy server. From then, it will be listed in the subscriber's *Registered Devices* page.

Registered Devices				
★ Create Permanent Registration				
Search: <input type="text"/>				
#	User Agent	Contact	Expires	
191	Yealink SIP-T23 44.80.0.5	sip:1234567102@10.15.16.101:5060;line=058ea33e27ec720	2018-02-01 15:57:16	

Showing 1 to 1 of 1 entries

← ← 1 → →

Figure 145: Registered devices

If you need to troubleshoot the provisioning process, the following logs would help you:

- /var/log/ngcp/nginx (e.g. SSL errors are collected here: autoprov_error.log)
- /var/log/ngcp/panel-debug.log (general provisioning logs)

Tip

In case you would like to edit a device model, firmware, configuration or profile, refer to Section [D.12](#)

18.1.6 Configuring Sound Sets for the Customer PBX

In the *Customer Details* view, there is a row *Sound Sets*, where the customer can define his own sound sets for *Auto Attendant*, *Music on Hold* and the *Office Hours Announcement*.

To create a new sound set, open the *Sound Sets* row and click *Create Sound Set*.

If you do this as administrator or reseller, the Reseller and/or Customer is pre-selected, so keep it as is. If you do this as customer, you don't see any *Reseller* or *Customer* fields.

So the important settings are:

- **Name:** The name of the sound set as it will appear in the *Subscriber Preferences*, where you can assign the sound set to a subscriber.
- **Description:** A more detailed description of the sound set.
- **Default for Subscribers:** If this setting is enabled, then the sound set is automatically assigned to all already existing subscribers which do NOT have a sound set assigned yet, and also for all newly created subscribers.

Fill in the settings and click *Save*.

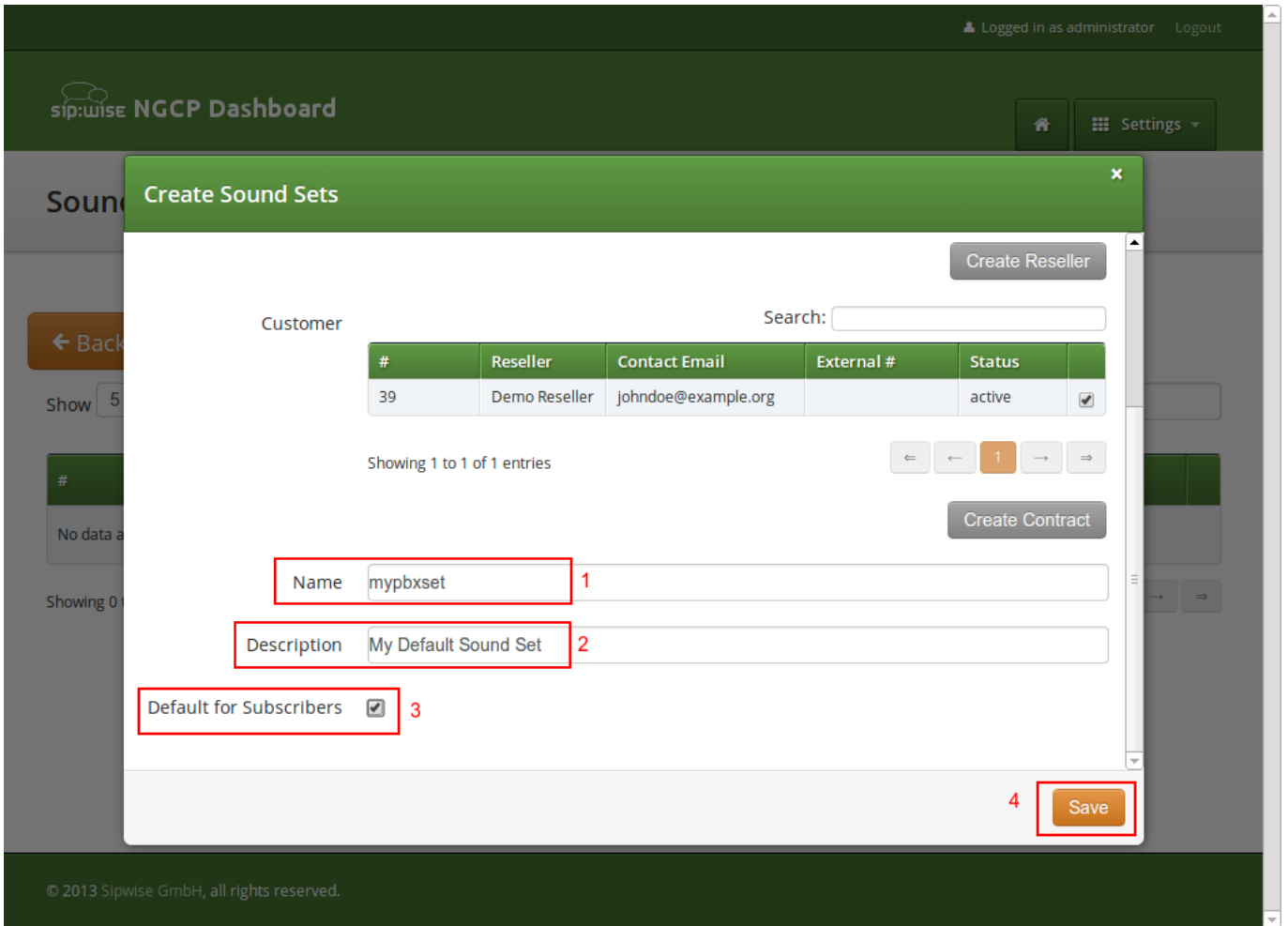

Figure 146: Create Customer Sound Set

To upload files to your Sound Set, click the *Files* button for the Sound Set.

18.1.6.1 Uploading a Music-on-Hold File

Open the *music_on_hold* row and click *Upload* on the *music_on_hold* entry. Choose a WAV file from your file system, and click the *Loopplay* setting if you want to play the file in a loop instead of just once. Click *Save* to upload the file.

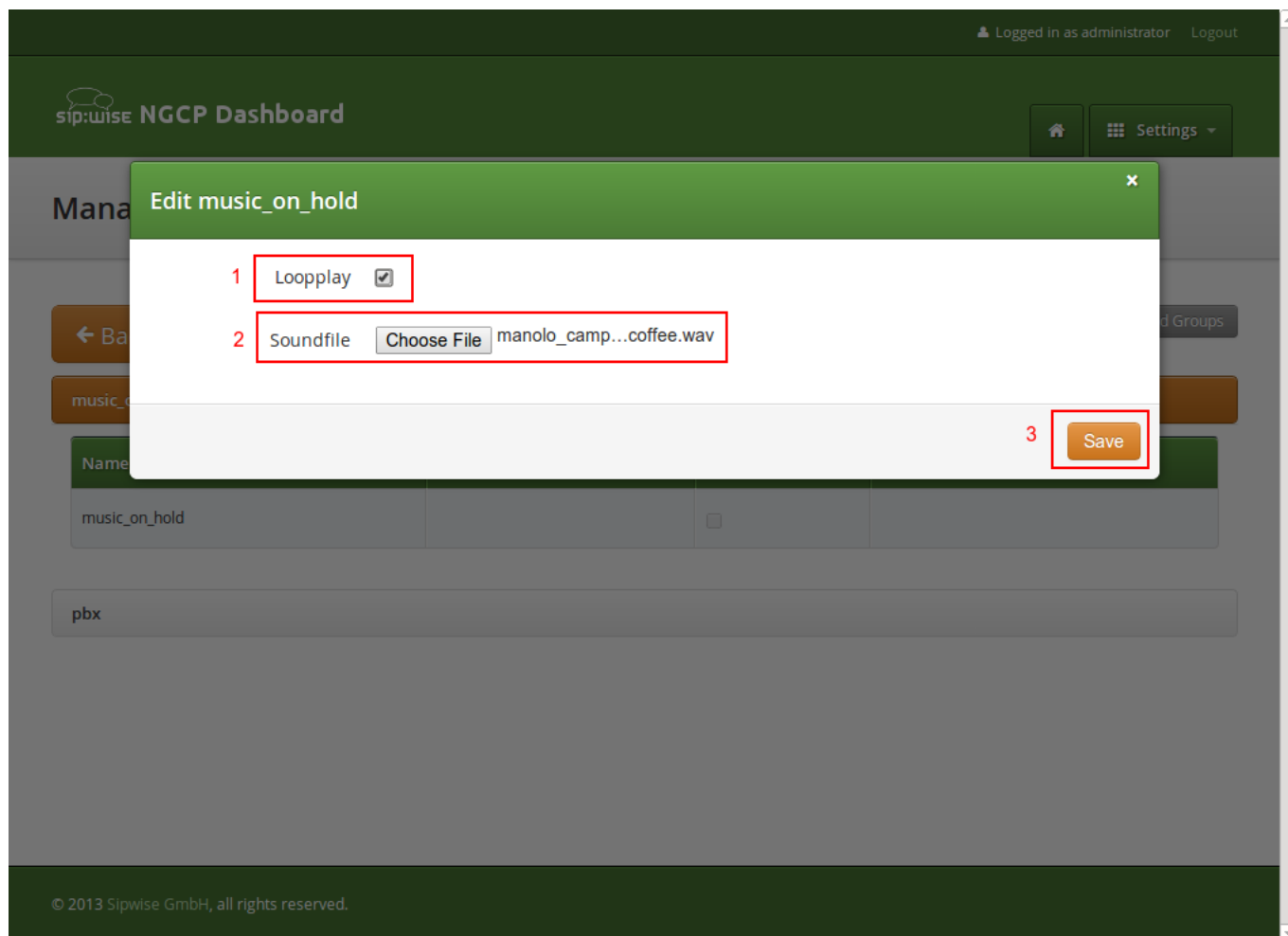

Figure 147: Upload MoH Sound File

18.1.7 Auto-Attendant Function

The *Auto-Attendant* is a built-in IVR feature that is available to Cloud PBX subscribers. It provides an automatic voice menu that enables the caller to select from a number of destinations, which could be other PBX subscribers or groups.

Another typical use case for the *Auto-Attendant* function is when the customer would like to have an "office assistant" that automatically takes incoming calls and routes them to the desired extension (i.e. to a subscriber).

The *Auto-Attendant* offers 2 ways of selecting the final call destination:

- *option selection*: selecting one of the pre-configured destinations by pressing a single digit (0-9)
- *extension dialing*: entering an arbitrary PBX extension number directly

18.1.7.1 Enabling the Auto-Attendant

The Auto-Attendant feature can be activated for any subscriber in the Customer PBX individually. There are three steps involved:

1. You have to prepare a *Sound Set* to have Auto-Attendant sound files.
2. You have to configure the destinations for the various options you provide (e.g. pressing 1 should go to the `marketing` subscriber, 2 to `development` and 3 to some external number).
3. You have to set a Call Forward to the Auto-Attendant.

To do so, go to *Customer Details* and in the *Subscribers* section, click the *Preferences* button of the subscriber, where the Auto-Attendant should be set.

18.1.7.2 Preparing the Sound Set

Create a Sound Set and upload the Sound Files for it as described below. Afterwards in the *Subscriber Preferences* view, set the *Customer Sound Set* preference to the Sound Set to be used. To do so, click *Edit* on the *Customer Sound Set* preference and assign the set to be used.

Uploading Auto-Attendant Sound Files

When configuring a Call Forward to the *Auto-Attendant*, it will play the following files:

- `aa_welcome`: This is the welcome message (the greeting) which is played when someone calls the Auto-Attendant.
- each available pair of `aa_X_for/aa_X_option`: Each menu item in the Auto-Attendant consists of two parts. The `for` part, which plays something like *Press One for*, and the `option` part, which play something like *Marketing*. The Auto-Attendant only plays those menu options where both the `for` part and the `option` part is present, so if you only have 3 destinations you'd like to offer, and you want them to be on keys 1, 2 and 3, you have to upload files for `aa_1_for`, `aa_1_option`, `aa_2_for`, `aa_2_option` and `aa_3_for` and `aa_3_option`.



Important

The sound files only define the general structure of what is being played to the caller. The actual destinations behind your options are configured separately in [Configuring the Auto-Attendant Slots](#).

An example configuration could look like this:

← Back
Expand Groups

Sound handle successfully uploaded

music_on_hold

pbx

Name	Filename	Loop	
aa_welcome	welcome.wav	<input type="checkbox"/>	
aa_1_for	press-1.wav	<input type="checkbox"/>	
aa_1_option	for-sales.wav	<input type="checkbox"/>	
aa_2_for	press-2.wav	<input type="checkbox"/>	
aa_2_option	for-service.wav	<input type="checkbox"/>	
aa_3_for	press-3.wav	<input type="checkbox"/>	
aa_3_option	for-tech-support.wav	<input type="checkbox"/>	
aa_4_for		<input type="checkbox"/>	
aa_4_option		<input type="checkbox"/>	
aa_5_for		<input type="checkbox"/>	

Figure 148: Upload Auto-Attendant Options Sound Files

In order to activate the **extension dialing** function within the Auto-Attendant, you have to upload the following prompt files:

- aa_star_for, aa_star_option: the announcement "Press star for connecting to an extension" (or similar message, depending on customer's needs)
- aa_enter_extension: will instruct the caller to enter the phone number of the extension he wants to connect to
- aa_invalid_extension: will be played when the phone number entered does not match any of the customer's extensions

aa_8_option		<input type="checkbox"/>
aa_9_for		<input type="checkbox"/>
aa_9_option		<input type="checkbox"/>
aa_enter_extension		<input type="checkbox"/>
aa_invalid_extension		<input type="checkbox"/>
aa_star_for		<input type="checkbox"/>
aa_star_option		<input type="checkbox"/>
aa_welcome		<input type="checkbox"/>
office_hours		<input type="checkbox"/>
queue_full		<input type="checkbox"/>

Figure 149: Upload Auto-Attendant Extension Dialing Sound Files

18.1.7.3 Auto-Attendant Flowchart with Voice Prompts

The illustration below shows the sequence of voice prompts played when Auto-Attendant feature is activated and a caller listens the IVR menu.

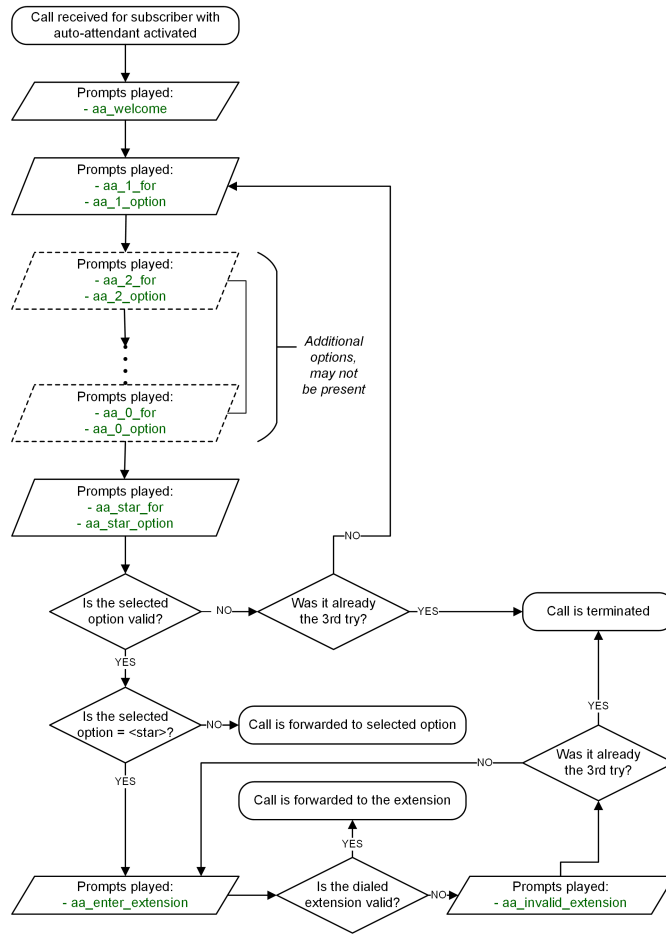

Figure 150: Flowchart of Auto-Attendant

18.1.7.4 Configuring the Auto-Attendant Slots

In the *Auto-Attendant Slots* section, click the *Edit Slots* button to configure the destination options. There are up to 10 available slots to configure, from keys 0 to 9.

Tip

Be aware that only configured slots will be prompted in the Auto-Attendant menu.

Click *Add another Slot* to add a destination option, select the Key the destination should be assigned to, and enter a Destination. The destination can be a subscriber username (e.g. marketing), a full SIP URI (e.g. sip:michelle.miller@customer1.pbx) or any external SIP URI) or a number or extension (e.g. 491234567 or 101).

Repeat the step for every option you want to add, then press *Save*.

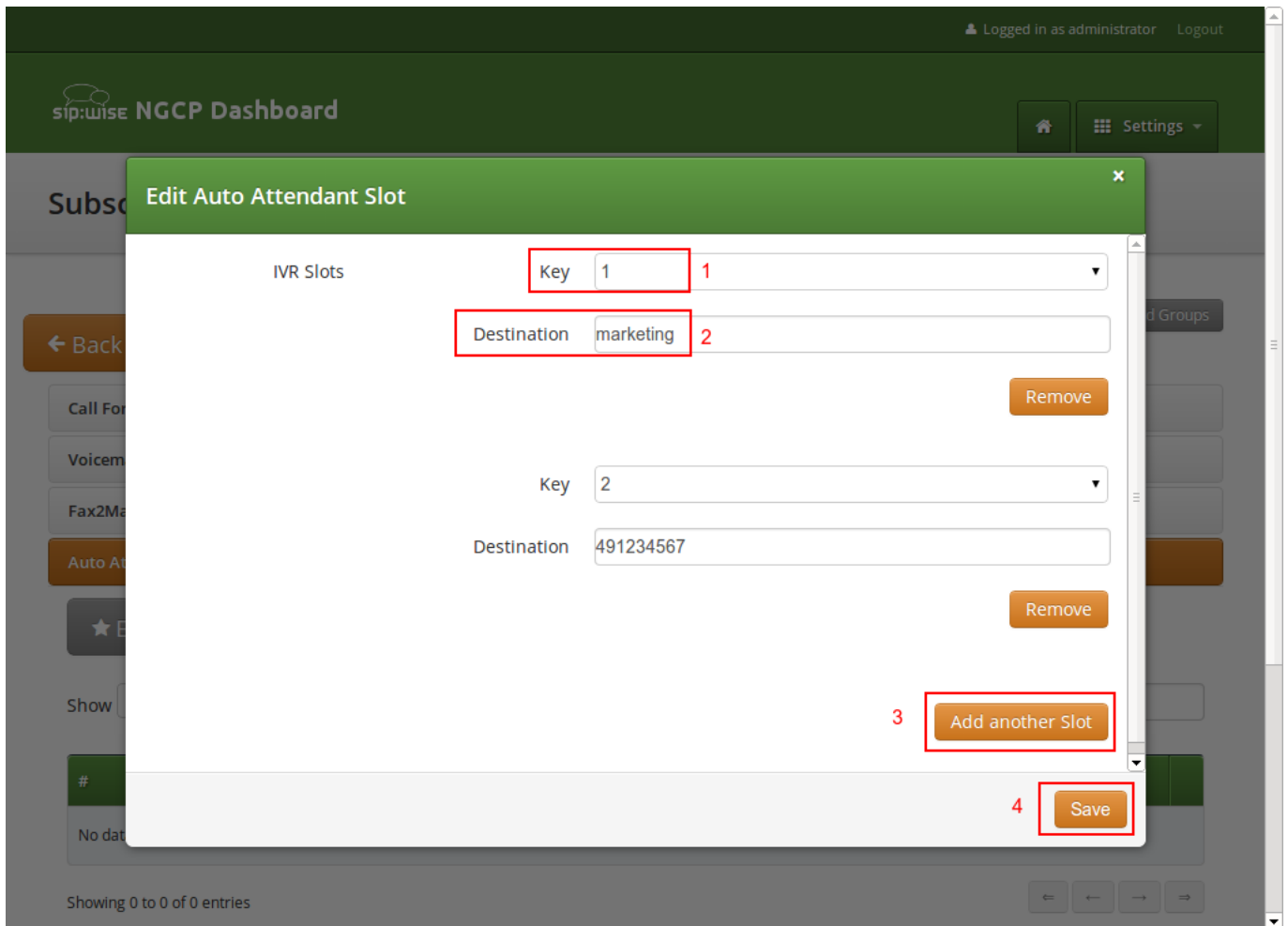

Figure 151: Define the Auto-Attendant Slots

18.1.7.5 Activating the Auto-Attendant

Once the Sound Set and the Slots are configured, activate the Auto-Attendant by setting a Call Forward to Auto-Attendant.

To do so, open the *Call Forwards* section in the *Subscriber Preferences* view and press *Edit* on the Call Forward type (e.g. *Call Forward Unconditional* if you want to redirect callers unconditionally to the Auto-Attendant).

Select *Auto-Attendant* and click *Save* to activate the Auto-Attendant.

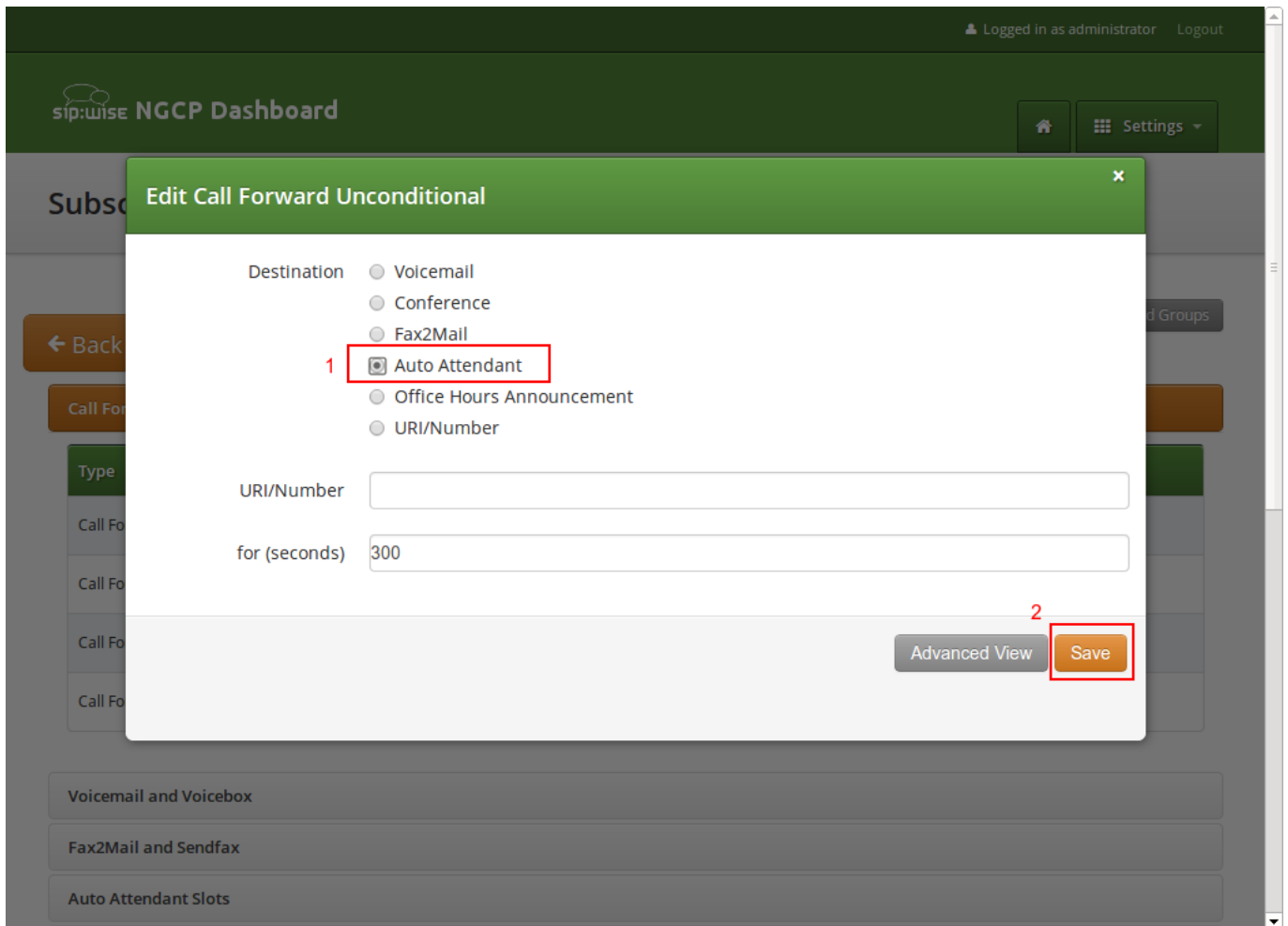

Figure 152: Set a Call Forward to Auto-Attendant

Tip

As with any other Call Forward, you can define more complex forwarding rules in the *Advanced View* to only forward the call to the Auto-Attendant during specific time periods, or as a fallback if no one picks up the office number.

18.1.8 Cloud PBX Groups with Busy Members

A *huntgroup* or a *PBX Group* is a Cloud PBX feature that distributes the calls between members of the group according to the configured hunt policy and timeout. The PBX group belongs to a customer and one Cloud PBX subscriber can be a member of one or more of the huntgroups of the customer. *Call Waiting* is a CPE (phone) feature that allows you to take another call while you're already on the phone.

Multiple incoming calls to the huntgroup may result in multiple calls delivered to the same subscriber if the Call Waiting feature is enabled on his phone, regardless whether the huntgroup members are busy at this time. Hence, busy subscribers may get a second incoming call. It may be an expected behavior (since one subscriber may have multiple devices and/or clients that all ring in parallel) or not, depending on the setup.

Therefore, Sipwise C5 Cloud PBX module offers *Skip busy huntgroup members* feature to check the busy status of individual huntgroup members before routing a call to them. This will leave subscribers on active phone calls undisturbed by calls to huntgroup.

The configuration of the *Skip busy huntgroup members* feature is done via the main configuration file: `/etc/ngcp-config/config`. The relevant section is: `kamailio.proxy.pbx.skip_busy_hg_members`, the example below shows the default values of the parameters.

```
skip_busy_hg_members:
  enable: no
  redis_key_name: 'totaluser'
```

Option `kamailio.proxy.pbx.skip_busy_hg_members.enable` determines if call destined to a huntgroup is routed to subscribers that have busy status. When enabled and huntgroup member is busy according to the active calls information in internal Redis storage the huntgroup call is not offered to this huntgroup member. The Sipwise C5 platform tries the other available HG members.

**Important**

This option does not present an extended server-side Call Waiting functionality. It concerns only the huntgroups' behavior. Hence subscriber would still be able to receive multiple calls when called directly (not via huntgroup) with Call Waiting enabled on his phone.

The option `redis_key_name` may take the following values:

- *totaluser*: The callee is busy when involved in one or more incoming or outgoing calls in active or alerting phase.
- *activeuser*: The callee is busy when involved in one or more incoming or outgoing calls in active or alerting phase but NOT busy for the calls that are forwarded.

When the feature is enabled with `redis_key_name` set to *totaluser*:

```
skip_busy_hg_members:
  enable: yes
  redis_key_name: 'totaluser'
```

The behavior when calling the huntgroup is the following:

- The callee is busy when involved in one or more incoming or outgoing calls in active or alerting phase.
- The callee is busy for incoming calls that are forwarded.

This can be better illustrated by the following use cases:

Use Case 1

Subscriber receives an incoming call. A second call is made to the HG. The subscriber should NOT receive this call via HG extension.

Use Case 2

Subscriber makes an outgoing call. A second call is made to the HG. The subscriber should NOT receive this call via HG extension.

Use Case 3

Subscriber with call forwards (CFU, CFB, CFNA, CFT) receives a call to his extension (not extension of HG) which is then forwarded. A second call is made to the HG. The subscriber should NOT receive the call via HG extension.

In order to prevent the forwarded calls from keeping the subscriber as "busy" for the purpose of this feature the platform administrator should set the `kamailio.proxy.pbx.skip_busy_hg_members.redis_key_name` parameter to value `activeuser`:

```
skip_busy_hg_members:
  enable: yes
  redis_key_name: 'activeuser'
```

While User Cases 1 and 2 will behave in the same way as described above, the change of behavior happens in Use Case 3:

Use Case 3

Subscriber with call forwards (CFU, CFB, CFNA, CFT) receives a call to his extension (not extension of HG) which is then forwarded. A second call is made to the HG. The subscriber should receive the call as normal.

There is a possibility to fine-tune when callee is considered busy and exclude, for example, intra-PBX calls or calls to voicemail from keeping subscriber as "busy". Please contact Sipwise support if you'd like to do that.

18.1.9 Configuring Call Queues

The Sipwise C5 platform offers call queueing feature for Cloud PBX subscribers. For any subscriber within the PBX Sipwise C5 system administrator or the subscriber himself may activate the *Call Queue*. This is done individually for each subscriber on demand.

If call queue activation has been done and the subscriber receives more than 1 call at a time, then the second and all further callers will be queued until the subscriber finishes his call with the first caller and gets free.

18.1.9.1 Activating the Call Queue

The call queue configuration is available at the path: *Subscribers* → *select one* → *Details* → *Preferences* → *Cloud PBX*.

Following configuration parameters may be set for call queueing:

- `cloud_pbx_callqueue` : shows the status of call queueing (enabled / disabled); by default it is disabled

- `max_queue_length` : the length of call queue, i.e. the maximum number of callers in a queue; the default is 5
- `queue_wrap_up_time` : the delay in seconds between the ending of the previous call and the connection of the next queued caller with the subscriber; the default is 10

In order to change the actual setting, press the *Edit* button in the relevant row.

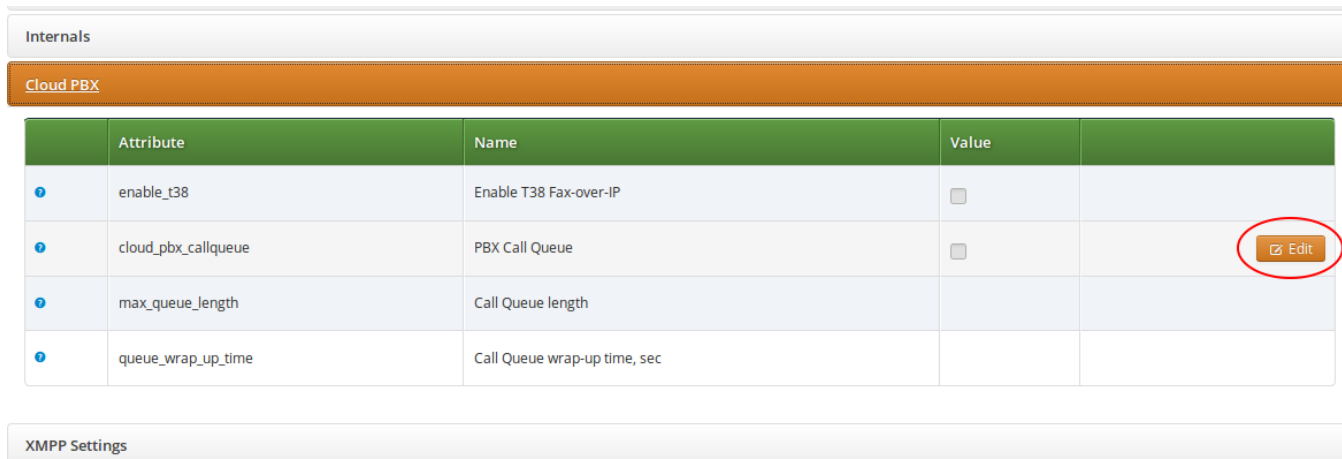

Figure 153: Call Queue Configuration

18.1.9.2 Call Queue Voice Prompts

Queued callers first hear a greeting message then information about their position in the queue and finally a waiting music / signal.

Table 25: Call Queue Voice Prompts

Prompt handle	Prompt content
<code>queue_greeting</code>	All lines are busy at the moment, you are being queued.
<code>queue_prefix</code>	You are currently number. . .
<code>queue_suffix</code>	. . . in the queue, please hold the line.
<code>queue_full</code>	All lines are busy at the moment, please try again later.
<code>queue_waiting_music</code>	<waiting music>

18.1.9.3 Call Queue Flowchart with Voice Prompts

The following illustration shows which voice prompts are played to the caller when the call gets into a queue.

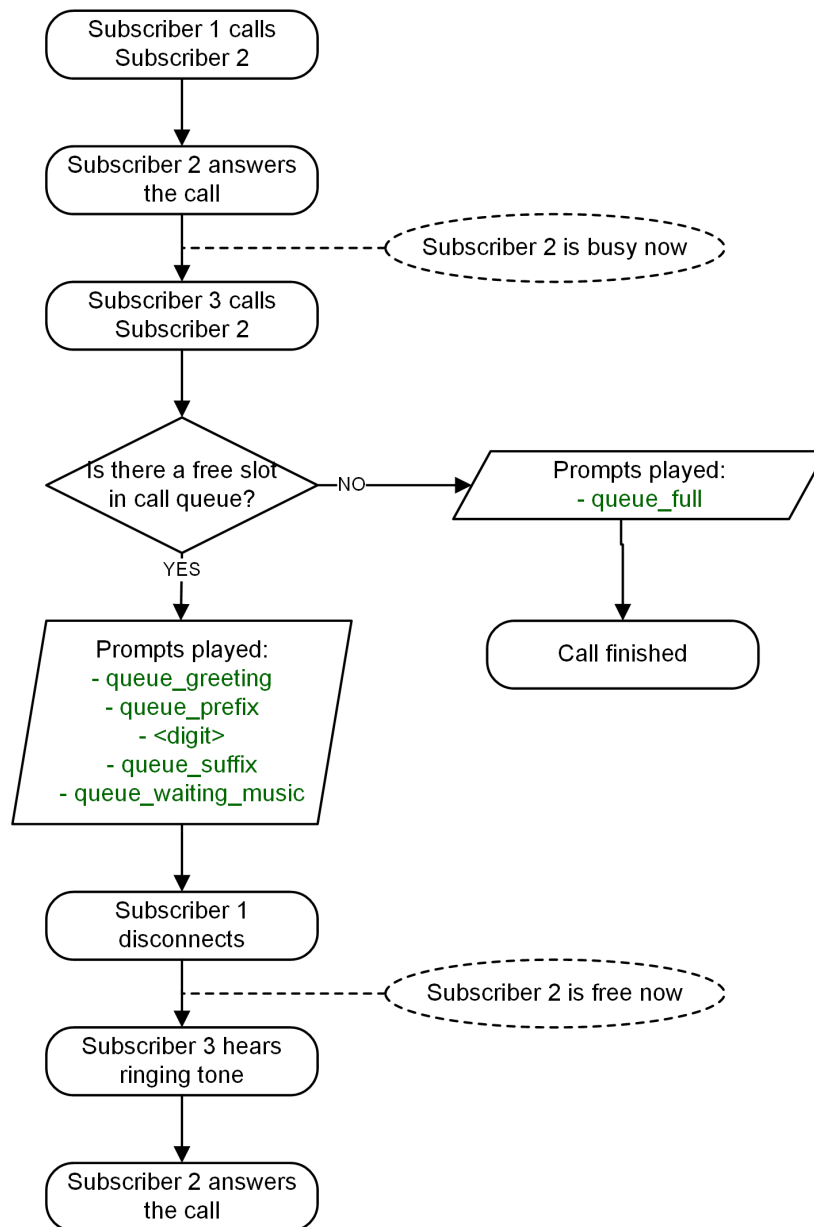

Figure 154: Flowchart of Call Queue

18.1.10 Device Auto-Provisioning Security

18.1.10.1 Server Certificate Authentication

The Cisco SPA phones can connect to the provisioning interface of the PBX via HTTP and HTTPS. When perform secure provisioning over HTTPS, the phones validate the server certificate to check if its a legitimate Cisco provisioning server. To pass this check, the provisioning interface must provide a certificate signed by Cisco for that exact purpose.

The following steps describe how to obtain such a certificate.

First, a new SSL key needs to be generated:

```
$ openssl genrsa -out provisioning.key 2048
Generating RSA private key, 2048 bit long modulus
...+++
.....+++
e is 65537 (0x10001)
```

Next, a certificate signing request needs to be generated as follows. Provide your company details.



Important

The **Common Name (e.g. server FQDN or YOUR name)** field is crucial here. Provide an FQDN which the phones will later use via DNS to connect to the provisioning interface, for example *pbx.example.org*. Cisco does **NOT** support wild-card certificates.



Important

Leave the password empty when asked for it (press Enter without entering anything).

```
$ openssl req -new -key provisioning.key -out provisioning.csr
You are about to be asked to enter information that will be incorporated
into your certificate request.
What you are about to enter is what is called a Distinguished Name or a DN.
There are quite a few fields but you can leave some blank
For some fields there will be a default value,
If you enter '.', the field will be left blank.
```

```
Country Name (2 letter code) [AU]:AT
State or Province Name (full name) [Some-State]:Vienna
Locality Name (eg, city) []:Vienna
Organization Name (eg, company) [Internet Widgits Pty Ltd]:Sipwise GmbH
Organizational Unit Name (eg, section) []:Operations
Common Name (e.g. server FQDN or YOUR name) []:pbx.example.org
Email Address []:office@sipwise.com
```

```
Please enter the following 'extra' attributes
to be sent with your certificate request
A challenge password []:
An optional company name []:
```

Finally, compress the `provisioning.csr` file via ZIP and send it to our Cisco sales representative. If in doubt, you can try to send it directly to `ciscosb-certadmin@cisco.com` asking them to sign it.

**Important**

Only send the CSR file. **Do NOT send the key file, as this is your private key!**

**Important**

Ask for both the signed certificate AND a so-called *combinedca.crt* which is needed to perform client authentication via SSL. Otherwise you can not restrict access to Cisco SPAs only.

You will receive a signed CRT file, which Sipwise can use to configure the PBX provisioning interface.

18.1.10.2 Client Certificate Authentication

If a client connects via HTTPS, the server also checks for the client certificate in order to validate that the device requesting the configuration is indeed a legitimate Cisco phone, and not a fraudulent user with a browser trying to fetch user credentials.

Cisco Client Root Certificate can be obtained from [Download Client Certificates](#) website.

18.1.11 Device Bootstrap and Resync Workflows

The IP phones supported by the PBX need to initially be configured to fetch their configuration from the system. Since the phones have no initial information about the system and its provisioning URL, they need to be boot-strapped. Furthermore, changes for a specific device might have to be pushed to the device immediately instead of waiting for it to re-fetch the configuration automatically.

The following sections describe the work-flows how this is accomplished without having the customer directly accessing the phone.

18.1.11.1 Cisco SPA Device Bootstrap

Initial Bootstrapping

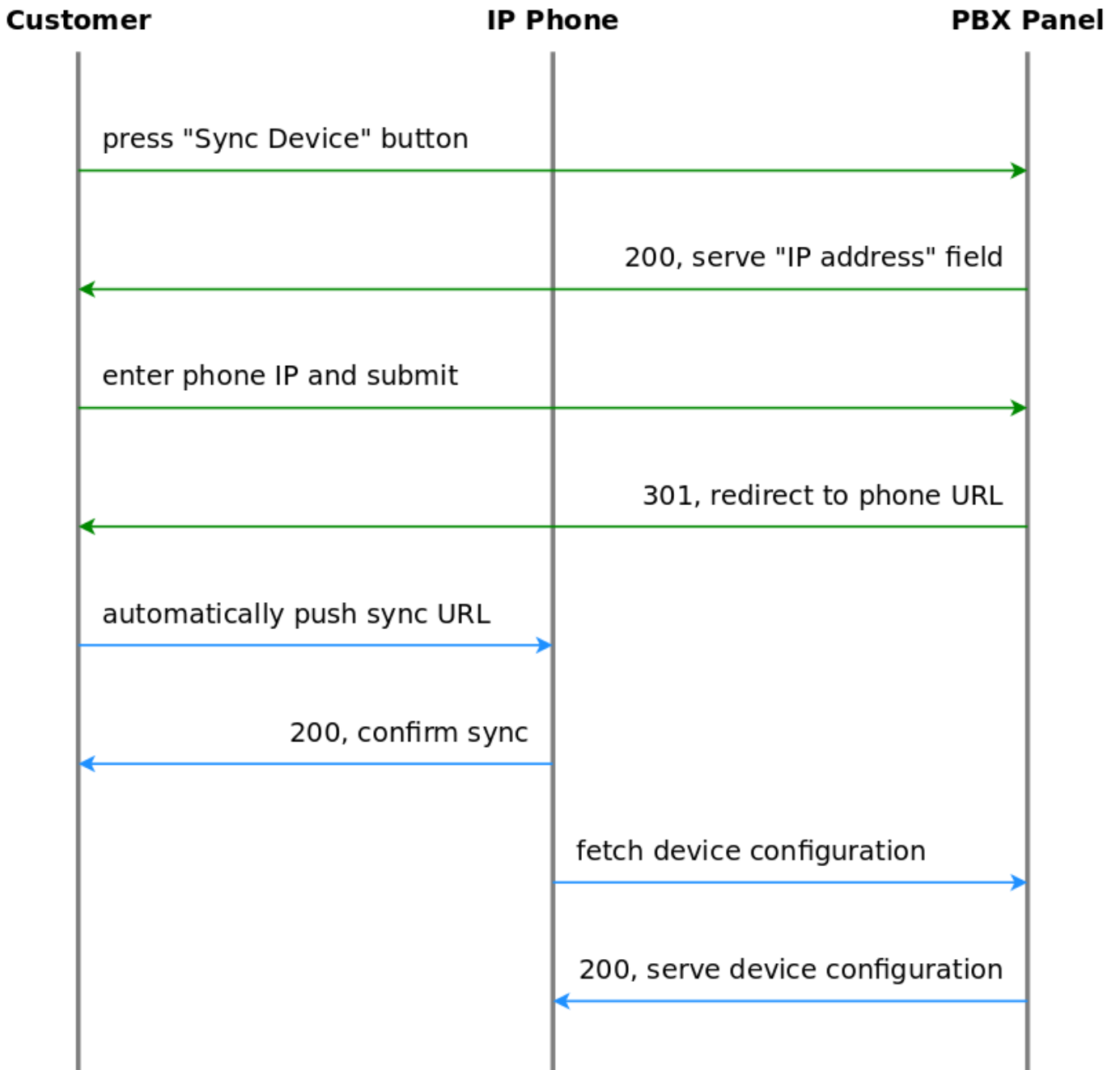

Figure 155: Initially bootstrap a PBX device

Subsequent Device Resyncs

If one of the subscribers configured on a PBX device is registered via SIP, the system can trigger a re-sync of the phone directly via SIP without having the customer enter the IP of the phone again. This is accomplished by sending a special NOTIFY message to the subscriber:

```
NOTIFY sip:subscriber@domain SIP/2.0
```

```
To: <sip:subscriber@domain>
From: <sip:subscriber@domain>;tag=some-random-tag
Call-ID: some-random-call-id
CSeq: 1 NOTIFY
Subscription-State: active
Event: check-sync
Content-Length: 0
```

In order to prevent unauthorized re-syncs, the IP phone challenges the request with its own SIP credentials, so the NOTIFY is sent twice, once without authentication, and the second time with the subscriber's own SIP credentials.

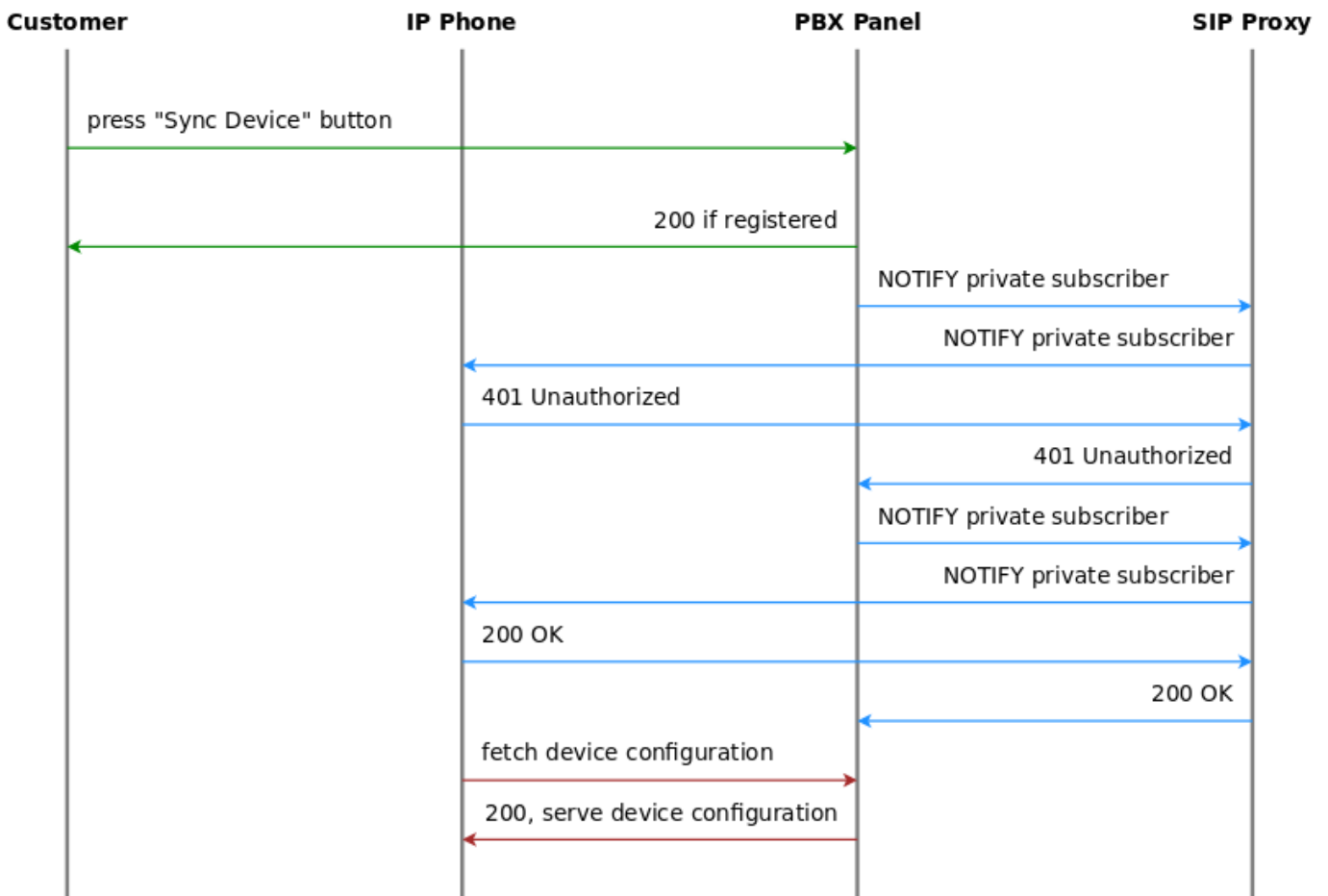

Figure 156: Resync a registered PBX device

18.1.11.2 Panasonic Device Bootstrap

Initial Bootstrapping

Panasonic provides a zero-touch provisioning mechanism in their firmwares, which causes the factory-reset phones to connect to a Panasonic web service at <https://provisioning.e-connecting.net> to check if a custom provisioning URL is configured for the MAC address of the phone. If an association between the MAC and a provisioning URL is found, the web service redirects the phone to the provisioning URL, where the phone connects to in order to obtain the configuration file.

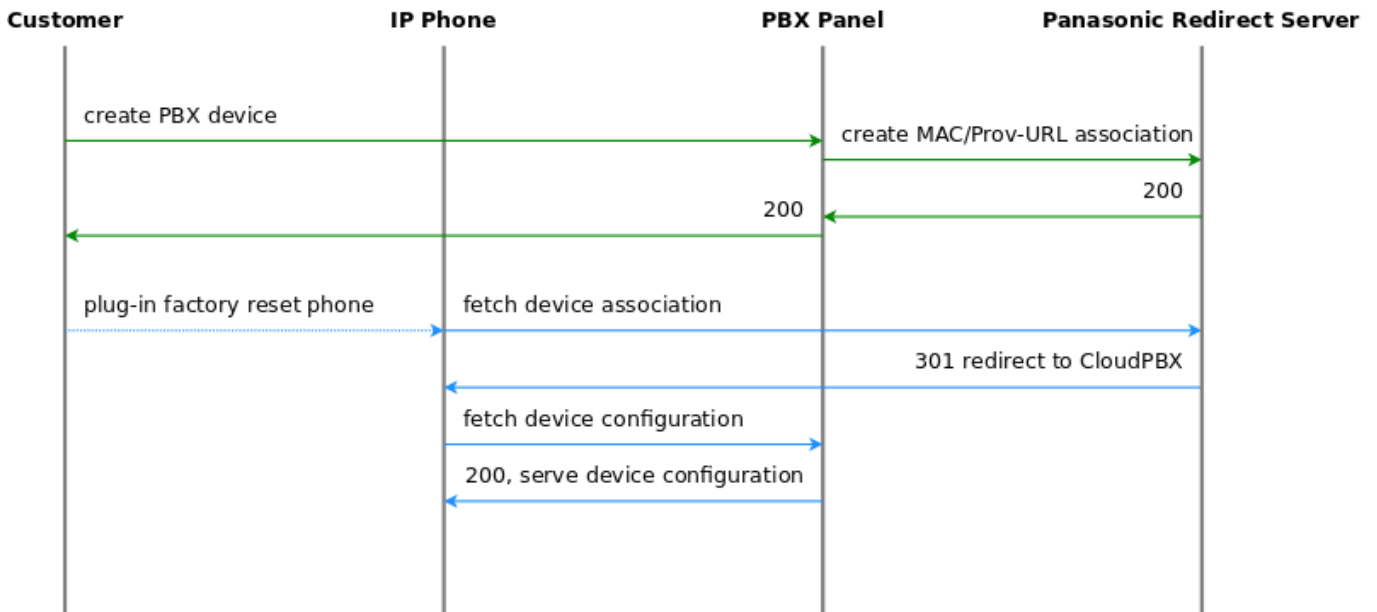

Figure 157: Initially bootstrap a Panasonic phone

The CloudPBX module ensures that when an end customer creates a Panasonic device, the MAC address is automatically provisioned on the Panasonic web service via an API call, so the customer's phone can use the correct provisioning URL to connect to the auto-provisioning server of the CloudPBX.

As a result, no customer interaction is required to bootstrap Panasonic phones, other than just creating the phone with the proper MAC on the CloudPBX web interface.

Factory Reset

For already provisioned phones, the end customer might need to perform a factory reset:

- Press *Settings* or *Setup*
- Enter *#136*
- Select *Factory Setting* and press *Enter*
- Select *Yes* and press *Enter*
- Select *Yes* and press *Enter*

The default username for factory-reset phones is *admin* with password *adminpass*.

Subsequent Device Resyncs

The same procedure as with Cisco SPA phones applies, once a subscriber configured on the phone is registered.

18.1.11.3 Yealink Device Bootstrap

Initial Bootstrapping

Yealink provides a zero-touch provisioning mechanism in their firmwares, which causes the factory-reset phones to connect to a Yealink web service at <https://rps.yealink.com> to check if a custom provisioning URL is configured for the MAC address of the phone. If an association between the MAC and a provisioning URL is found, the web service redirects the phone to the provisioning URL, where the phone connects to in order to obtain the configuration file.

If both Cisco SPA and Yealink phones are used, an issue with the Cisco-signed server certificate configured on the provisioning port (1444 by default) of the CloudPBX provisioning server arises. Yealink phones by default only connect to trusted server certificates, and the Cisco CA certificate used to sign the server certificate is not trusted by Yealink. Therefore, a two-step approach is used to disable the trusted check via a plain insecure http port (1445 by default) first, where only device-generic config options are served. No user credentials are provided in this case, because no SSL client authentication can be performed. The generic configuration disables the trusted check, and at the same time changes the provisioning URL to the secure port, where the Yealink phone is now able to connect to.

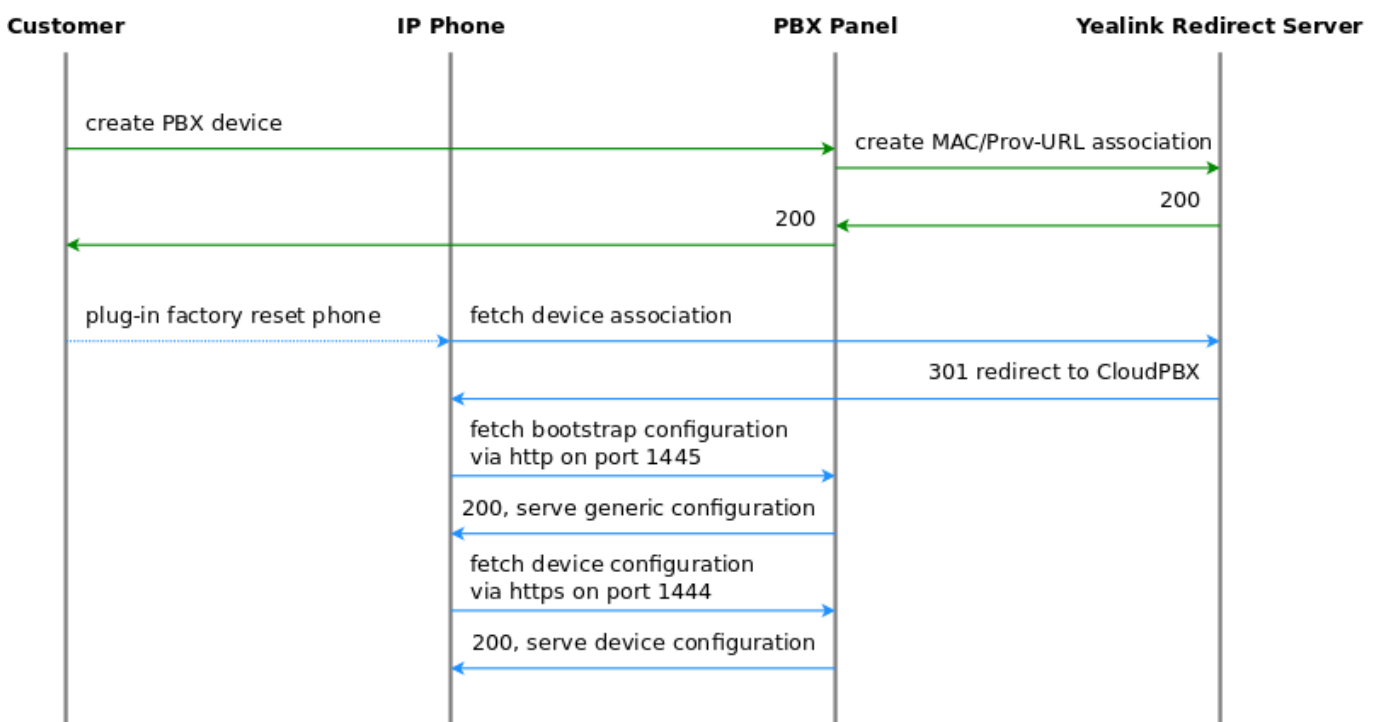

Figure 158: Initially bootstrap a Yealink phone

The CloudPBX module ensures that when an end customer creates a Yealink device, the MAC address is automatically provisioned on the Yealink web service via an API call, so the customer’s phone can use the correct insecure bootstrap provisioning URL to connect to the auto-provisioning server of the CloudPBX for the generic configuration, which in turn provides the information on where to connect to for the secure, full configuration.

As a result, no customer interaction is required to bootstrap Yealink phones, other than just creating the phone with the proper MAC on the CloudPBX web interface.

Factory Enable Yealink Auto-Provisioning

Older Yealink firmwares don’t automatically connect to the Yealink auto-provisioning server on initial boot, so it needs to be enabled manually by the end customer.

- Log in to `http://phone-ip/servlet?p=hidden&q=load` using `admin` and `admin` as user/password when prompted
- Change `Redirect Active` to `Enabled`
- Press `Confirm` and power-cycle phone

Subsequent Device Resyncs

The same procedure as with Cisco SPA phones applies, once a subscriber configured on the phone is registered.

18.1.11.4 Audiocodes Mediant Device Bootstrap and Configuration

Initial Bootstrapping

An Audiocodes device provides a zero-touch provisioning mechanism in its firmware which causes a factory-reset device to connect to the URL built into the firmware. This URL is pointing to Sipwise C5 provisioning server (in case of Sipwise C5 Carrier: `web01` node) listening on TCP port 1444 for HTTPS sessions.

The prerequisites for the device provisioning are that the device has a routable IP address and can reach the IP address of Sipwise C5 provisioning interface.

The Audiocodes device should request the firmware file or CLI configuration file from Sipwise C5 platform. The firmware versions and CLI config versions are decoupled from each other; Sipwise C5 can not enforce specific version of the firmware on the device. Instead, it should be requested by the device itself. In other words, provisioning is a *pull* and not a *push* process.

Sipwise C5 expects the provisioning request from the Audiocodes device after SSL handshake and serves the requested file to the device if the device provides valid MAC address as the part of the URL. The MAC address is used to identify the device to Sipwise C5 platform. The firmware and CLI config files are provided at the following URLs:

- the base URL to download firmwares: `https://<NGCP_IP>:1444/device/autoprov/firmware/001122334455/fro`
- the base URL to download CLI config: `https://<NGCP_IP>:1444/device/autoprov/config/001122334455`

where 001122334455 should be replaced with the actual device's MAC address and `<NGCP_IP>` with IP address of Sipwise C5 provisioning interface.

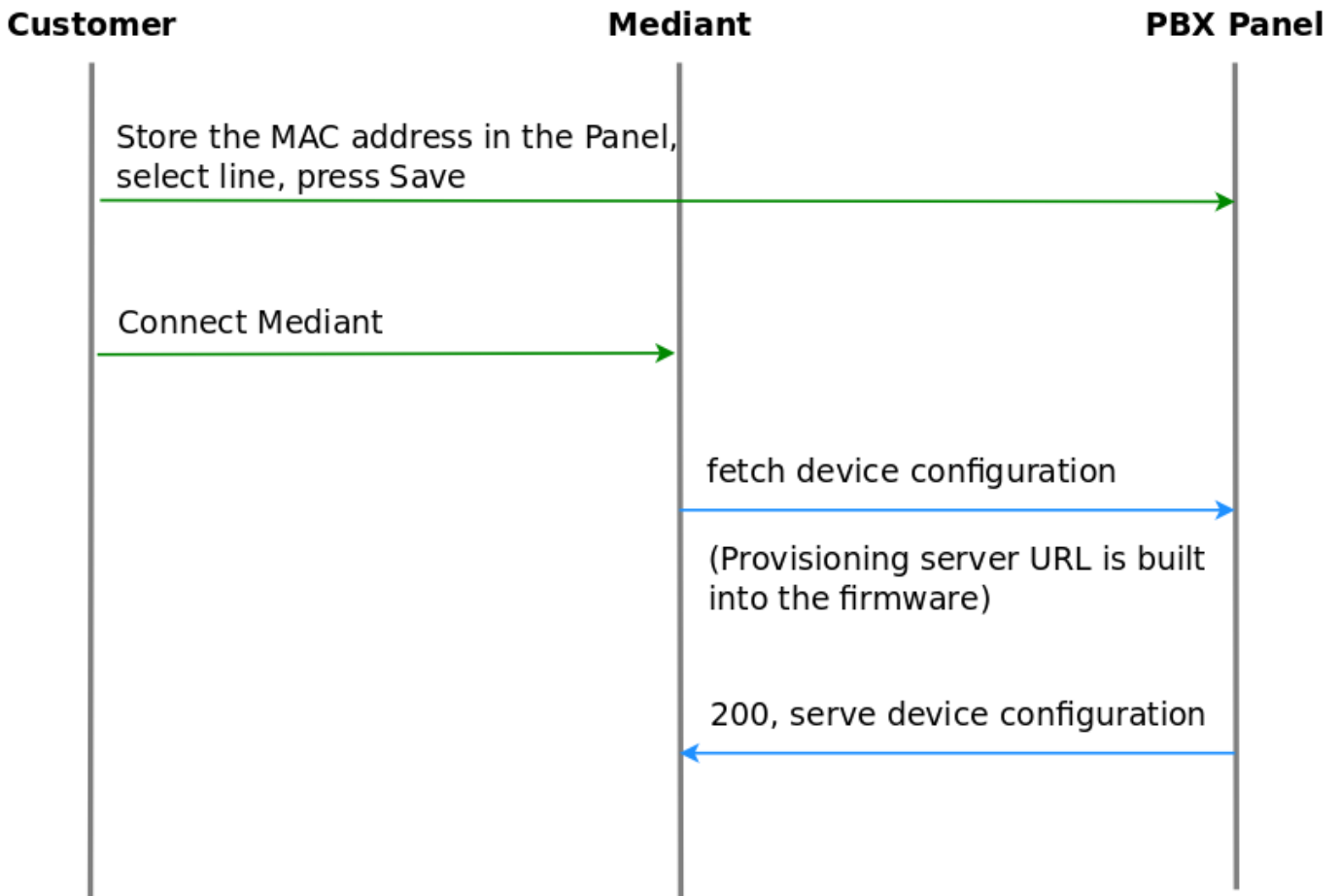

Figure 159: Initially bootstrap a Mediant gateway

Device management basics

The list of device models, firmwares and configurations are global to a reseller and are available for end customer. This data is initially provided by Sipwise as bulk upload of all supported phone models. The firmwares and settings are stored in the database on the DB node pair(s). The Sipwise C5 leverages the Cloud PBX module with its template system to generate the configurations and firmware files from database on the fly. Please refer to the following chapters in Sipwise C5 handbook for the current information on how to perform device management:

- [Uploading device firmwares](#)
- [Creating device configuration](#)
- [Creating device profiles](#)

Parameterizing the Device Configuration Template

The device-specific parameters are filled in by the system individually when a physical device fetches its configuration file. Parameters from Sipwise C5 panel:

- `username`: Subscriber Details → Master Data → SIP Username

- `password`: Subscriber Details → Master Data → SIP Password
- `domain`: Subscriber Details → Master Data → Domain
- `extension`: Subscriber Details → Master Data → Extension
- `area code`: Subscriber Preferences → Number Manipulations → ac
- `country code`: Subscriber Preferences → Number Manipulations → cc

The produced **CLI config file** has the following structure:

1. SIP account credentials:

```
"sip-definition account 0"
```

- `user-name` [username]
- `password` [password]
- `host-name` [domain]
- `register` reg
- `contact-user` "[country code][area code][extension]"

2. IP Groups:

```
"voip-network ip-group 1" and "voip-network ip-group 2"
```

- `sip-group-name` [domain]

3. Proxy and registration settings:

```
"sip-definition proxy-and-registration"
```

- `set gw-name` [domain]

4. Manipulations:

- `manipulation-name` "from trunk domain":

```
"sbc manipulations message-manipulations 3"
```

```
- action-value "[% line.domain %]"
```

- `manipulation-name` "clip no screening":

```
"sbc manipulations message-manipulations 8"
```

```
- action-value "'< sip:[country code][area code][extension]@' + param.ipg.dst.host + '>'"
```

Specific CLI parameters are:

- [IPPBX_Hostname]
- [IPPBX_server_IP]

which are used at the following configuration parameters:

- Proxy settings:

```
"voip-network proxy-ip 1"
```

```
- proxy-address [IPPBX_Hostname]
```

- Manipulations:

```
"sbc manipulations message-manipulations 1"
```

```
- action-value [IPPBX_Hostname]
```

18.1.12 Device Provisioning and Deployment Workflows

This chapter provides information and hints for preparing and performing the deployment of certain VoIP devices at customer sites, that have a customer-facing interface which also needs customisation.

18.1.12.1 Audiocodes Mediant Device Provisioning Workflow

Audiocodes ISDN gateways and eSBCs are devices used to connect legacy (ISDN) PBX and IP-PBX to Sipwise C5 platform and maintain their operations within the Operator's network. Sipwise C5 offers a *SipConnect 1.1* compliant signaling and media interface to connect SIP trunks to the platform. In addition to this interface, Sipwise C5 provides an auto-provisioning mechanism to configure SIP endpoints like IP phones, media gateways and eSBCs.

Provisioning URL

An Audiocodes device needs to obtain the provisioning URL of Sipwise C5 in one way or the other to request its device configuration and subsequently download specific firmwares, obtain SIP credentials to connect to the network facing side, and configure the customer facing side for customer devices to connect either via ISDN or SIP. Typical ways of obtaining the provisioning URL for a SIP endpoint are:

- using DHCP option-66 (in a pre-staging environment or directly at the customer premise) where vendor-specific Redirect Servers are configured in the default configuration or firmware
- getting pre-configured per deployment from the SIP endpoint vendor
- getting pre-configured per deployment by a 3rd party distributor

The assumption is that Audiocodes devices are supplied with a firmware (and all required SSL certificates) being pre-configured and the provisioning URL pointing to an Operator URL Sipwise C5 is serving, before handing the devices over to field service engineers doing the truck rolls.

Field Configuration

The Sipwise C5 provides a SipConnect 1.1 compliant interface on the network side for the Audiocodes devices. This interface clearly defines the numbering formats of the calling and called party, the SIP header mechanisms to provide CLI restriction, the RTP codecs, etc.

On the customer facing side, however, those variables might be different from deployment to deployment:

- An IP-PBX might choose to only send its extension as calling party number, or might choose to send the full number in national format.
- It might choose to use the SIP From-header mechanisms to suppress displaying of the CLI, or use the SIP Privacy header.
- The same uncertainty exists to some extent for a legacy PBX connecting via ISDN to the Audiocodes device.

The assumption here is that a field service engineer is NOT supposed to change the Audiocodes configuration in order to make the customer interface work, as this will lead to big issues in maintaining those local changes, especially if a replacement of the device is necessary. Instead, the Audiocodes configuration must ensure that all different kinds of variants in terms of SIP headers, codecs and number formats are translated correctly to the network side and vice versa. If it turns out that there are scenarios in the field which are not handled correctly, temporary local changes might be performed to finish a truck roll, but those changes MUST be communicated to the platform operator, and the server-side configuration templates must be adapted to handle those scenarios gracefully as well.

For deployments with ISDN interfaces on the customer facing side of the Audiocodes, different *Device Profiles* with specific *Device Configurations* per *Device Model* must exist to handle certain scenarios, specifically whether the ISDN interface is operating in Point-to-Point or Point-to-Multipoint mode. Configuration options like which side is providing the clock-rate are to be defined up-front, and the PBX must be reconfigured to adhere to the configuration.

Network Configuration

On the network facing side, both the ISDN and eSBC style deployments have to be designed to obtain an IP address via DHCP. The definition of the IP address ranges is up to the Operator. It may or may not be NAT-ed, but it is advised to use a private IP range directly routed in the back-bone to avoid NAT.

On the customer facing side, networking is only relevant for the eSBC deployment. In order to make the IP-PBX configuration as stream-lined as possible, a pre-defined network should be established on the customer interface of the Audiocodes device.

Tip

The proposal is to define a network 192.168.255.0/24 with the Audiocodes device using the IP 192.168.255.2 (leaving the 192.168.255.1 to a possible gateway). The IP-PBX could obtain its IP address via DHCP from a DHCP server running on the Audiocodes device (e.g. serving IP addresses in the range of 192.168.255.100-254), or could have it configured manually (e.g. in the range of 192.168.255.3-99). Since the Audiocodes device IP on the customer side is always fixed at 192.168.255.2, the IP-PBX for each customer can be configured the same way, pointing the SIP proxy/registrar or outbound proxy always to this IP.

The customer facing side is outside the Sipwise demarcation line, that's why the network configuration mentioned above only serves as proposal and any feedback is highly welcome. However, it must be clearly communicated how the customer facing network is going to be configured, because Sipwise C5 needs to incorporate this configuration into the Audiocodes configuration templates.

18.1.12.2 Audiocodes Mediant Device Deployment Workflow

Pre-Configuration on Sipwise C5 platform

1. Before connecting a customer to a SIP trunk, it must be clear which Audiocodes *Device Model* is going to be used (depending on if, which and how many ISDN ports are necessary) and which *Device Profile* for the *Device Model* is required (eSBC mode, ISDN P-to-P or P-to-MP mode). Based on that, the correct physical device must be picked.
2. Next, the customer has to be created on Sipwise C5 . This step requires the creation of the customer, and the creation of a subscriber within this customer. For the subscriber, the proper E.164 numbers or number blocks must be assigned, and the correct subscriber preferences must be set for the network interface to adhere to the SipConnect 1.1 interface. This step is automated by a script provided by Sipwise until the provisioning work-flow is fully integrated with Operator's OSS/BSS systems. *Required parameters are:*
 - an external customer id to relate the customer entity on Sipwise C5 with a customer identifier in Operator's IT systems
 - a billing profile name
 - a subscriber username and password, the domain the subscriber is configured for
 - the numbers or number blocks assigned to the subscriber, and the network provided number of the subscriber
 - optional information is geographic location information and IP network information to properly map emergency calls
3. Finally, the association between the MAC address of the Audiocodes device and the SIP subscriber to be used on the SIP trunk must be established. This step is also automated by a script provided by Sipwise. *Required parameters are:*
 - the subscriber id
 - the Device Profile to be used
 - and the MAC address of the Audiocodes device

Installation

Once the above requirements are fulfilled and the customer is created on Sipwise C5 , the Audiocodes device can be installed at the customer premise.

When the Audiocodes device boots, it requests the configuration file from Sipwise C5 by issuing a GET request via HTTPS.

For **authentication and authorization** purposes, Sipwise C5 requests an SSL client certificate from the device and will check whether it's signed by a Certificate Authority known to Sipwise C5 . Therefore, Audiocodes must provide the CA certificate used to sign the devices' client certificates to Sipwise to allow for this process. Also, Sipwise C5 will provide an SSL server certificate to the device. The device must validate this certificate in order to prevent man-in-the-middle attacks. Options here are to have:

- Sipwise provide a self-signed certificate to Audiocodes for Audiocodes or a 3rd party distribution partner to configure it as trusted CA in the pre-staging process
- the Operator provide a certificate signed by a CA which is already in the trust store of the Audiocodes devices.

Once the secured HTTPS connection is established, Sipwise C5 will provide a CLI style configuration file, with its content depending on the pre-configured *Device Profile* and subscriber association to the device's MAC address.

The configuration includes the firmware version of the latest available firmware configured for the *Device Model*, and a URL defining from where to obtain it. The configuration details on how the Audiocodes devices manage the scheduling of firmware updates are to be provided by Audiocodes or its partners, since this is out of scope for Sipwise. Ideally, firmware updates should only be performed if the device is idle (no calls running), and within a specific time-frame (e.g. between 1 a.m. and 5 a.m. once a certain firmware version is reached, including some random variation to prevent all devices to download a new firmware version at the same time).

Device Replacement

If a customer requires the replacement of a device, e.g. due to hardware issues or due to changing the number or type of ISDN interfaces, a new association of the new device MAC, its *Device Profile* and the subscriber must be established.

In order to make the change as seamless as possible for the customer, a new device is created for the customer with the new MAC, a proper *Device Profile*, but the same subscriber as used on the old device. Once the new device boots at the customer premise, it will obtain its configuration and will register with the same subscriber as the old device (in case it's still operational). For inbound calls to the customer, this will cause parallel ringing to take place, and it's up to the customer or the field engineer when to re-configure or re-cable the PBX to connect to one or the other device.

Once the old device is decommissioned, the old MAC association can be deleted on Sipwise C5 .

18.1.13 List of available pre-configured devices

Vendor	Model	Available from release
ALE	8008	mr7.0.1.1
ALE	8018	mr7.0.1.1
ALE	8028	mr7.0.1.1
ALE	8058	mr7.0.1.1
ALE	8068	mr7.0.1.1
ALE	8078	mr7.0.1.1
ALE	AOM10	mr7.0.1.1
ALE	AOM40	mr7.0.1.1

Vendor	Model	Available from release
ALE	AOMEL	mr7.0.1.1
Audiocodes	Mediant800	mr4.1.1.1
Cisco	ATA112	mr3.4.1.1
Cisco	ATA122	mr3.4.1.1
Cisco	SPA232D	mr3.4.1.1
Cisco	SPA301	mr3.4.1.1
Cisco	SPA303	mr3.4.1.1
Cisco	SPA501G	mr3.4.1.1
Cisco	SPA502G	mr3.4.1.1
Cisco	SPA512G	mr3.4.1.1
Cisco	SPA504G	mr3.4.1.1
Cisco	SPA504G + SPA500S	mr3.7.1.4
Cisco	SPA504G + two SPA500S	mr3.7.1.4
Cisco	SPA514G	mr3.4.1.1
Cisco	SPA508G	mr3.4.1.1
Cisco	SPA509G	mr3.4.1.1
Cisco	SPA525G	mr3.4.1.1
Grandstream	HT814	mr5.1.1.1
Grandstream	GXW-4008	mr5.1.1.1
Grandstream	GXW-4216	mr5.1.1.1
Innovaphone	IP2X2X	mr3.8.3.3
Innovaphone	IP230-X	mr3.8.3.3
Innovaphone	IP232	mr3.8.3.3
Innovaphone	IP222	mr3.8.3.3
Innovaphone	IP240	mr3.8.3.3
Innovaphone	IP22	mr3.8.3.3
Innovaphone	IP111	mr3.8.3.3
Panasonic	KX-UT113	mr3.7.1.1
Panasonic	KX-UT123	mr3.7.1.1
Panasonic	KX-UT133	mr3.7.1.1
Panasonic	KX-UT136	mr3.7.1.1
Panasonic	KX-UT248	mr3.7.1.1
Panasonic	KX-TGP600	mr5.1.1.1
Panasonic	KX-HDV330	mr5.1.1.1
Panasonic	KX-HDV230	mr5.1.1.1
Panasonic	KX-HDV130	mr5.1.1.1
Polycom	VVX300	mr5.4.1.1
Polycom	VVX400	mr5.4.1.1
Polycom	VVX500	mr5.4.1.1
Yealink	CP860	mr5.2.1.1
Yealink	SIP-T19P	mr3.7.1.1
Yealink	SIP-T20P	mr3.7.1.1
Yealink	SIP-T21P	mr3.7.1.1

Vendor	Model	Available from release
Yealink	SIP-T22P	mr3.7.1.1
Yealink	SIP-T23P	mr3.7.1.1
Yealink	SIP-T23G	mr3.7.1.1
Yealink	SIP-T26P	mr3.7.1.1
Yealink	SIP-T28P	mr3.7.1.1
Yealink	SIP-T28P + EXP39	mr3.8.1.1
Yealink	SIP-T28P + two EXP39	mr3.8.1.1
Yealink	SIP-T32G	mr3.7.1.1
Yealink	SIP-T38G	mr3.7.1.1
Yealink	SIP-T41P	mr3.7.1.1
Yealink	SIP-T42G	mr3.7.1.1
Yealink	SIP-T46G	mr3.7.1.1
Yealink	SIP-T48G	mr3.7.1.1
Yealink	SIP-T53	mr8.5.1.1
Yealink	SIP-T54W	mr8.5.1.1
Yealink	SIP-T57W	mr8.5.1.1
Yealink	W52P	mr3.7.1.6

18.1.13.1 Alcatel-Lucent Enterprise (ALE) Devices

Model	IPv6	TLS	SRTP	Auto provisioning	Private Line	Shared Line	Busy Lamp	Speed Dial	Extension Boards
8008	Y	Y	Y	redirect	1	0	0	N	N
8018	Y	Y	Y	redirect	1	0	0	N	N
8028	Y	Y	Y	redirect	1	0	0	N	N
8058	Y	Y	Y	redirect	1	1	1	N	Y
8068	Y	Y	Y	redirect	1	1	1	N	Y
8078	Y	Y	Y	redirect	1	1	1	N	Y
AOM10	N	N	N	device	1	0	1	Y	Y
AOM40	N	N	N	device	1	0	1	Y	Y
AOMEL	N	N	N	device	1	0	1	Y	Y

18.1.13.2 Audiocodes Devices

Model	IPv6	TLS	SRTP	Auto provisioning	Private Line	Shared Line	Busy Lamp	Speed Dial
Mediant800	Y	Y	Y	dhcp	1	0	0	N

18.1.13.3 Cisco Devices

IP Phones

Model	IPv6	TLS	SRTP	Auto provisioning	Private Line	Shared Line	Busy Lamp	Extension Boards
SPA301	N	Y	Y	http	1	1	0	N
SPA303	N	Y	Y	http	1-3	1-3	1-2	N
SPA501G	N	Y	Y	http	1-8	1-8	1-7	N
SPA502G	N	Y	Y	http	1	1	0	N
SPA512G	N	N	Y	http	1	1	0	N
SPA504G	N	Y	Y	http	1-4	1-4	1-3	2
SPA514G	N	N	Y	http	1-4	1-4	1-3	N
SPA508G	N	Y	Y	http	1-8	1-8	1-7	N
SPA509G	N	Y	Y	http	1-12	1-12	1-11	N
SPA525G	N	Y	N	http	1-5	1-5	1-4	N

Analog Adapters

Model	IPv6	TLS	SRTP	Auto provisioning	Private Line	Shared Line	Busy Lamp
SPA232D	N	Y	Y	http	1-6	0	0
ATA112	Y	Y	Y	http	1-2	0	0
ATA122	Y	Y	Y	http	1-2	0	0

Extension Boards

Model	Ports	Buttons	Busy Lamp	Supported phones
SPA500S	2	32	1-32	SPA500

18.1.13.4 Grandstream Devices

Analog Adapters

Model	IPv6	TLS	SRTP	Auto provisioning	Private Line	Shared Line	Busy Lamp
HT814	N	Y	Y	redirect	4	N	N
GXW-4008	N	Y	Y	redirect	8	N	N
GXW-4216	N	Y	Y	redirect	16	N	N

18.1.13.5 Innovaphone Devices

IP Phones

Model	IPv6	TLS	SRTP	Auto provisioning	Private Line	Shared Line	Busy Lamp	Extension Boards
IP232	N	Y	Y	dhcp	1	0	1-16	2

Model	IPv6	TLS	S RTP	Auto provisioning	Private Line	Shared Line	Busy Lamp	Extension Boards
IP222	N	Y	Y	dhcp	1	0	1-16	2
IP240	N	N	N	dhcp	1	0	1-15	2
IP111	N	Y	Y	dhcp	1	0	1-16	0

Analog Adapters

Model	IPv6	TLS	S RTP	Auto provisioning	Private Line	Shared Line	Busy Lamp
IP22	N	Y	Y	dhcp	1	0	0

Extension Boards

Model	Ports	Buttons	Busy Lamp	Supported phones
IP2X2X	2	64	1-32	IP2x2
IP230-X	2	30	1-30	IP230

18.1.13.6 Panasonic Devices

IP Phones

Model	IPv6	TLS	S RTP	Auto provisioning	Private Line	Shared Line	Busy Lamp	Extension Boards
KX-UT113	N	N	N	redirect	1-2	1-2	0	N
KX-UT123	N	N	N	redirect	1-2	1-2	0	N
KX-UT133	N	N	N	redirect	1-4	1-4	1-23	N
KX-UT136	N	N	N	redirect	1-4	1-4	1-23	N
KX-UT248	N	N	Y	redirect	1-6	1-6	1-23	N
KX-TGP600	Y	Y	Y	redirect	1-8	N	N	N
KX-HDV330	Y	Y	Y	redirect	1-12	Y	Y	N
KX-HDV230	Y	Y	Y	redirect	1-6	Y	Y	N
KX-HDV130	Y	Y	Y	redirect	1-2	Y	Y	N

18.1.13.7 Polycom Devices

IP Phones

Model	IPv6	TLS	S RTP	Auto provisioning	Private Line	Shared Line	Busy Lamp	Extension Boards
VVX300	N	N	Y	redirect	1-6	1-6	Y	N
VVX400	N	N	Y	redirect	1-12	1-12	Y	N
VVX500	N	N	Y	redirect	1-12	1-12	Y	N

18.1.13.8 Yealink Devices**IP Phones**

Model	IPv6	TLS	SRTP	Auto provisioning	Private Line	Shared Line	Busy Lamp	Extension Boards
CP860	Y	Y	Y	redirect	1	N	N	N
SIP-T19P	Y	Y	Y	redirect	1	1	0	N
SIP-T20P	Y	Y	Y	redirect	1	1	0	N
SIP-T21P	Y	Y	Y	redirect	1-2	1-2	1	N
SIP-T22P	Y	Y	Y	redirect	1-3	1-3	1-2	N
SIP-T23P	Y	Y	Y	redirect	1-3	1-3	1-2	N
SIP-T23G	Y	Y	Y	redirect	1-3	1-3	1-2	N
SIP-T26P	Y	Y	Y	redirect	1-3	1-3	1-12	N
SIP-T28P	Y	Y	Y	redirect	1-6	1-6	1-15	2
SIP-T32G	Y	Y	Y	redirect	1-3	1-3	1-2	N
SIP-T38G	Y	Y	Y	redirect	1-6	1-6	1-15	N
SIP-T41P	Y	Y	Y	redirect	1-3	1-3	1-14	N
SIP-T42G	Y	Y	Y	redirect	1-3	1-3	1-14	N
SIP-T46G	Y	Y	Y	redirect	1-6	1-6	1-26	N
SIP-T48G	Y	Y	Y	redirect	1-6	1-6	1-28	N
W52P	N	Y	Y	redirect	1-5	1-5	0	N

18.1.14 Phone features**18.1.14.1 Cisco phones****SPA301****1) Soft keys**

Not available.

2) Hard keys

- vm
- hold/unhold

3) Line keys

Not available.

4) VSC

- directed pickup

- park/unpark

SPA303

1) Soft keys

Idle:

redial	lcr	dir	dnd >
< cfwd	unpark		

Idle with missed calls:

lcr			miss
-----	--	--	------

Call:

hold	endCall	conf	xfer >
< bxfer	park		

Call on hold:

resume	endCall	newCall	redial >
< dir	cfwd	dnd	

Ringling:

answer	ignore		
--------	--------	--	--

2) Hard keys

- vm
- hold/unhold

3) Line keys

- BLF monitoring
- directed pickup

4) VSC

- directed pickup

SPA501G**1) Soft keys****Idle:**

redial	lcr	dir	dnd >
< cfwd	unpark		

Idle with missed calls:

lcr			miss
-----	--	--	------

Call:

hold/resume	endCall	conf	xfer >
< bxfer	park		

Call on hold:

resume	endCall	newCall	redial >
< dir	cfwd	dnd	

Ringing:

answer	reject		
--------	--------	--	--

2) Hard keys

- vm
- hold/unhold

3) Line keys

- BLF monitoring
- directed pickup

4) VSC

- directed pickup

SPA502G**1) Soft keys**

Idle:

redial	lcr	dir	dnd >
< cfwd	unpark		

Idle with missed calls:

lcr			miss
-----	--	--	------

Call:

hold/resume	endCall	conf	xfer >
< bxfer	park		

Call on hold:

resume	endCall	newCall	redial >
< dir	cfwd	dnd	

Ringling:

answer	reject		
--------	--------	--	--

2) Hard keys

- vm
- hold/unhold

3) Line keys

Not available.

4) VSC

- directed pickup

SPA504G**1) Soft keys****Idle:**

redial	lcr	dir	dnd >
< cfwd	unpark		

Idle with missed calls:

lcr			miss
-----	--	--	------

Call:

hold/resume	endCall	conf	xfer >
< bxfer	park		

Call on hold:

resume	endCall	newCall	redial >
< dir	cfwd	dnd	

Ringing:

answer	reject		
--------	--------	--	--

2) Hard keys

- vm
- hold/unhold

3) Line keys

- BLF monitoring
- directed pickup

4) VSC

- directed pickup

SPA512G**1) Soft keys****Idle:**

redial	lcr	dir	dnd >
< cfwd	unpark		

Idle with missed calls:

lcr			miss
-----	--	--	------

Call:

hold/resume	endCall	conf	xfer >
< bxfer	park		

Call on hold:

resume	endCall	newCall	redial >
< dir	cfwd	dnd	

Ringing:

answer	reject		
--------	--------	--	--

2) Hard keys

- vm
- hold/unhold

3) Line keys

Not available.

4) VSC

- directed pickup

SPA514G**1) Soft keys****Idle:**

redial	lcr	dir	dnd >
< cfwd	unpark		

Idle with missed calls:

lcr			miss
-----	--	--	------

Call:

hold/resume	endCall	conf	xfer >
< bxfer	park		

Call on hold:

resume	endCall	newCall	redial >
< dir	cfwd	dnd	

Ringing:

answer	reject		
--------	--------	--	--

2) Hard keys

- vm
- hold/unhold

3) Line keys

- BLF monitoring
- directed pickup

4) VSC

- directed pickup

SPA509G**1) Soft keys****Idle:**

redial	lcr	dir	dnd >
< cfwd	unpark		

Idle with missed calls:

lcr			miss
-----	--	--	------

Call:

hold/resume	endCall	conf	xfer >
-------------	---------	------	--------

< bxfer	park		
---------	------	--	--

Call on hold:

resume	endCall	newCall	redial >
< dir	cfwd	dnd	

Ringing:

answer	reject		
--------	--------	--	--

2) Hard keys

- vm
- hold/unhold

3) Line keys

- BLF monitoring
- directed pickup

4) VSC

- directed pickup

SPA508G**1) Soft keys****Idle:**

redial	lcr	dir	dnd >
< cfwd	unpark		

Idle with missed calls:

lcr			miss
-----	--	--	------

Call:

hold/resume	endCall	conf	xfer >
< bxfer	park		

Call on hold:

resume	endCall	newCall	redial >
< dir	cfwd	dnd	

Ringing:

answer	reject		
--------	--------	--	--

2) Hard keys

- vm
- hold/unhold

3) Line keys

- BLF monitoring
- directed pickup

4) VSC

- directed pickup

SPA525G

1) Soft keys

Idle:

Redial	call Rtn	Directory	DND >
< Forward	Unpark		

Idle with missed calls:

Call Rtn			Miss
----------	--	--	------

Call:

Hold	End Call	Conf	Transfer >
BlindXfer	Park		

Call on hold:

Resume	EndCall	EewCall	Redial >
< Directory	Forward	DND	

Ringing:

Answer	Ignore		
--------	--------	--	--

2) Hard keys

- vm
- hold/unhold

3) Line keys

- BLF monitoring
- directed pickup

4) VSC

- directed pickup

18.1.14.2 Yealink phones

T19P

1) Soft keys

Idle:

History		DND	Menu
---------	--	-----	------

Idle with missed calls:

Exit			View
------	--	--	------

Call:

Tran	Hold	Conf	Cancel
------	------	------	--------

Call on hold:

Tran	Resume	NewCall	Cancel
------	--------	---------	--------

Ringling:

Answer	FWD	Silence	Reject
--------	-----	---------	--------

2) Hard keys

- vm
- redial
- transfer

3) Line keys

Not available.

4) VSC

- transfer park
- directed pick up
- park/unpark

T20P**1) Soft keys****Idle:**

History		DND	Menu
---------	--	-----	------

Idle with missed calls:

Exit			View
------	--	--	------

Call:

Tran	Hold	Conf	Cancel
------	------	------	--------

Call on hold:

Tran	Resume	NewCall	Cancel
------	--------	---------	--------

Ringling:

Answer	FWD	Silence	Reject
--------	-----	---------	--------

2) Hard keys

- vm
- redial
- transfer

3) Line keys

- BLF monitoring
- directed pickup

4) VSC

- transfer park
- park/unpark

T21P**1) Soft keys****Idle:**

History		DND	Menu
---------	--	-----	------

Idle with missed calls:

Exit			View
------	--	--	------

Call:

Tran	Hold	Conf	Cancel
------	------	------	--------

Call on hold:

Tran	Resume	NewCall	Cancel
------	--------	---------	--------

Ringling:

Answer	FWD	Silence	Reject
--------	-----	---------	--------

2) Hard keys

- vm
- redial
- transfer

3) Line keys

- BLF monitoring
- directed pickup

4) VSC

- transfer park
- park/unpark

T22P

1) Soft keys

Idle:

History		DND	Menu
---------	--	-----	------

Idle with missed calls:

Exit			View
------	--	--	------

Call:

Tran	Hold	Conf	Cancel
------	------	------	--------

Call on hold:

Tran	Resume	NewCall	Cancel
------	--------	---------	--------

Ringling:

Answer	FWD	Silence	Reject
--------	-----	---------	--------

2) Hard keys

- vm
- redial

- transfer

3) Line keys

- BLF monitoring
- directed pickup

4) VSC

- park/unpark
- transfer park

T23P

1) Soft keys

Idle:

History		DND	Menu
---------	--	-----	------

Idle with missed calls:

Exit			View
------	--	--	------

Call:

Tran	Hold	Conf	Cancel
------	------	------	--------

Call on hold:

Tran	Resume	NewCall	Cancel
------	--------	---------	--------

Ringling:

Answer	FWD	Silence	Reject
--------	-----	---------	--------

2) Hard keys

- vm
- redial
- transfer

3) Line keys

- BLF monitoring
- directed pickup

4) VSC

- park/unpark
- transfer park

T23G**1) Soft keys****Idle:**

History	Dir	DND	Menu
---------	-----	-----	------

Idle with missed calls:

Exit			View
------	--	--	------

Call:

Tran	Hold	Conf	EndCall
------	------	------	---------

Call on hold:

Tran	Resume	NewCall	EndCall
------	--------	---------	---------

Ringng:

Answer	FWD		Reject
--------	-----	--	--------

2) Hard keys

- vm
- redial
- transfer

3) Line keys

- BLF monitoring
- directed pickup

4) VSC

- unpark
- transfer park

T26P

1) Soft keys

Idle:

History		DND	Menu
---------	--	-----	------

Idle with missed calls:

Exit			View
------	--	--	------

Call:

Tran	Hold	Conf	Cancel
------	------	------	--------

Call on hold:

Tran	Resume	NewCall	Cancel
------	--------	---------	--------

Ringling:

Answer	FWD	Silence	Reject
--------	-----	---------	--------

2) Hard keys

- vm
- redial
- transfer

3) Line keys

- BLF monitoring
- directed pickup

4) VSC

- unpark
- transfer park

T28P**1) Soft keys****Idle:**

History		DND	Menu
---------	--	-----	------

Idle with missed calls:

Exit			View
------	--	--	------

Call:

Tran	Hold	Conf	Cancel
------	------	------	--------

Call on hold:

Tran	Resume	NewCall	Cancel
------	--------	---------	--------

Ringing:

Answer	FWD	Silence	Reject
--------	-----	---------	--------

2) Hard keys

- vm
- redial
- transfer

3) Line keys

- BLF monitoring
- directed pickup

4) VSC

- park/unpark
- transfer park

T32G

1) Soft keys

Idle:

History		DND	Menu
---------	--	-----	------

Idle with missed calls:

Exit			View
------	--	--	------

Call:

Tran	Hold	Conf	Cancel
------	------	------	--------

Call on hold:

Tran	Resume	NewCall	Cancel
------	--------	---------	--------

Ringling:

Answer	FWD	Silence	Reject
--------	-----	---------	--------

2) Hard keys

- vm
- redial
- transfer

3) Line keys

- BLF monitoring
- directed pickup

4) VSC

- unpark
- transfer park

T38G**1) Soft keys****Idle:**

History		DND	Menu
---------	--	-----	------

Idle with missed calls:

Exit			View
------	--	--	------

Call:

Tran	Hold	Conf	Cancel
------	------	------	--------

Call on hold:

Tran	Resume	NewCall	Cancel
------	--------	---------	--------

Ringling:

Answer	FWD	Silence	Reject
--------	-----	---------	--------

2) Hard keys

- vm
- redial
- transfer

3) Line keys

- BLF monitoring
- directed pickup

4) VSC

- unpark
- transfer park

T41P**1) Soft keys**

Idle:

History		DND	Menu
---------	--	-----	------

Idle with missed calls:

Exit			View
------	--	--	------

Call:

Tran	Hold	Conf	Cancel
------	------	------	--------

Call on hold:

Tran	Resume	NewCall	Cancel
------	--------	---------	--------

Ringing:

Answer	FWD	Silence	Reject
--------	-----	---------	--------

2) Hard keys

- vm
- redial
- transfer

3) Line keys

- BLF monitoring
- directed pickup

4) VSC

- park/unpark
- transfer park

T42G**1) Soft keys****Idle:**

History		DND	Menu
---------	--	-----	------

Idle with missed calls:

Exit			View
------	--	--	------

Call:

Tran	Hold	Conf	Cancel
------	------	------	--------

Call on hold:

Tran	Resume	NewCall	Cancel
------	--------	---------	--------

Ringling:

Answer	FWD	Silence	Reject
--------	-----	---------	--------

2) Hard keys

- vm
- redial
- transfer

3) Line keys

- BLF monitoring
- directed pickup

4) VSC

- park/unpark
- transfer park

T46G**1) Soft keys****Idle:**

History		DND	Menu
---------	--	-----	------

Idle with missed calls:

Exit			View
------	--	--	------

Call:

Tran	Hold	Conf	Cancel
------	------	------	--------

Call on hold:

Tran	Resume	NewCall	Cancel
------	--------	---------	--------

Ringling:

Answer	FWD	Silence	Reject
--------	-----	---------	--------

2) Hard keys

- vm
- redial
- transfer

3) Line keys

- BLF monitoring
- directed pickup

4) VSC

- park/unpark
- transfer park

T48G**1) Soft keys****Idle:**

History		DND	Menu
---------	--	-----	------

Idle with missed calls:

Exit			View
------	--	--	------

Call:

Tran	Hold	Conf	Cancel
------	------	------	--------

Call on hold:

Tran	Resume	NewCall	Cancel
------	--------	---------	--------

Ringing:

Answer	FWD	Silence	Reject
--------	-----	---------	--------

2) Hard keys

- vm
- redial
- transfer

3) Line keys

- BLF monitoring
- directed pickup

4) VSC

- park/unpark
- transfer park

W52P**1) Soft keys****Idle:**

History	Line
---------	------

Idle with missed calls:

Exit	View
------	------

Call:

Ext. Call	Options
-----------	---------

Call on hold:

Resume	Line
--------	------

Ringing:

Accept	
--------	--

2) Hard keys

- vm
- redirect

3) VSC

- park/unpark
- transfer park

18.1.14.3 Panasonic phones

KX-UT113

1) Soft keys

Idle:

Settings	Call Log	Phone book	
----------	----------	------------	--

Call:

Blind		Phone book	
-------	--	------------	--

Call on hold:

	Call Log	Phone book	
--	----------	------------	--

Ringing:

Answer		Reject	
--------	--	--------	--

2) Hard keys

- vm
- forward/dnd
- hold/unhold
- redial
- recall
- transfer
- conf

3) Line keys

Not available.

4) VSC

- park/unpark
- transfer park

KX-UT123

1) Soft keys

Idle:

Settings	Call Log	Phone book	
----------	----------	------------	--

Call:

Blind		Phone book	
-------	--	------------	--

Call on hold:

	Call Log	Phone book	
--	----------	------------	--

Ringling:

Answer		Reject	
--------	--	--------	--

2) Hard keys

- vm
- forward/dnd
- hold/unhold
- redial
- recall
- transfer
- conf

3) Line keys

Not available.

4) VSC

- park/unpark
- transfer park

KX-UT133

1) Soft keys

Idle:

Settings	Call Log	Phone book	
----------	----------	------------	--

Call:

Blind		Phone book	
-------	--	------------	--

Call on hold:

	Call Log	Phone book	
--	----------	------------	--

Ringling:

Answer		Reject	
--------	--	--------	--

2) Hard keys

- vm
- forward/dnd

- hold/unhold
- redial
- recall
- transfer
- conf

3) Line keys

- BLF monitoring
- directed pickup

4) VSC

- unpark
- transfer park

KX-UT136

1) Soft keys

Idle:

Settings	Call Log	Phone book	
----------	----------	------------	--

Call:

Blind		Phone book	
-------	--	------------	--

Call on hold:

	Call Log	Phone book	
--	----------	------------	--

Ringling:

Answer		Reject	
--------	--	--------	--

2) Hard keys

- vm
- forward/dnd

- hold/unhold
- redial
- recall
- transfer
- conf

3) Line keys

- BLF monitoring
- directed pickup

4) VSC

- park/unpark
- transfer park

KX-UT248

1) Soft keys

Idle:

Settings	Call Log	Phone book	
----------	----------	------------	--

Call:

Blind		Phone book	
-------	--	------------	--

Call on hold:

	Call Log	Phone book	
--	----------	------------	--

Ringling:

Answer		Reject	
--------	--	--------	--

2) Hard keys

- vm
- forward/dnd

- hold/unhold
- redial
- recall
- transfer
- conf

3) Line keys

- BLF monitoring
- directed pickup

4) VSC

- park/unpark
- transfer park

18.1.14.4 Innovaphone

IP222

1) Soft keys

Idle:

Setup	All Calls	Home	Calls	My favorites	Phonebook
-------	-----------	------	-------	--------------	-----------

Call:

Hold	Transfer	Park	Cancel
------	----------	------	--------

Call on hold:

Resume	Transfer	Park	Cancel
--------	----------	------	--------

Ringling:

Answer	Transfer	Silence	Reject
--------	----------	---------	--------

2) Hard keys

- hold

- redial

3) Line keys

- BLF monitoring

4) VSC

- unpark
- transfer park

IP232

1) Soft keys

Idle:

Setup	All Calls	Home	Calls	My favorites	Phonebook
-------	-----------	------	-------	--------------	-----------

Call:

Hold	Transfer	Park	Cancel
------	----------	------	--------

Call on hold:

Resume	Transfer	Park	Cancel
--------	----------	------	--------

Ringling:

Answer	Transfer	Silence	Reject
--------	----------	---------	--------

2) Hard keys

- hold
- redial

3) Line keys

- BLF monitoring

4) VSC

- unpark

- transfer park

IP111

1) Soft keys

Idle:

Setup	All Calls	Home	Calls	My favorites	Phonebook
-------	-----------	------	-------	--------------	-----------

Call:

Hold	Transfer	Park	Cancel
------	----------	------	--------

Call on hold:

Resume	Transfer	Park	Cancel
--------	----------	------	--------

Ringling:

Answer	Transfer	Silence	Reject
--------	----------	---------	--------

2) Hard keys

- hold
- redial

3) Line keys

- BLF monitoring

4) VSC

- unpark
- transfer park

IP240

1) Soft keys

Not available.

2) Hard keys

- hold

- redial
- conference
- dnd
- forward

3) Line keys

- BLF monitoring

4) VSC

- transfer park
- unpark

18.1.15 Shared line appearance

In PBX environment, shared line appearance is supported for PBX subscribers. In comparison to the private line, subscriber registering for the shared line will, immediately after the successful registration, subscribe for Call-Info event. This subscribe is challenged for authentication and if the credentials are provided, subscriber is notified that the subscription is active. In the respective NOTIFY message, this is reflected in Subscription-State header set to active. NOTIFY also contains information about the status of the shared line in Call-Info header. If the appearance is not used, Call-Info header will describe the state as idle. In the NOTIFY message, this is reflected as “appearance-index=*;appearance-state=idle”.

If there is incoming call to the subscriber, the appearance index is created after the call is accepted and state will be set to active. Call-Info header will contain “appearance-index=1; appearance-state=active”. After call is finished and appearance is not used elsewhere, appearance index is removed and state is set to idle. In the case of outgoing call, subscription to line-seize event is required to be able to dial. Before dialing can be started, SUBSCRIBE to line-seize is sent. Consequently, subscriber receives NOTIFY for line-seize with active subscription state. Call-info subscription is updated accordingly, appearance is created and its state is set to seized. As soon as the call starts ringing, Call-Info status is updated to progressing and line-seize subscription is set to terminated with “reason=noresource” in Subscription-State header. When the call is accepted, Call-Info status is changed to active and set again to idle when call is finished. Also, the appearance index is removed.

18.2 Sipwise sip:phone App (SIP client)

Sipwise provides a commercial Unified Communication Client for full end-to-end integration of voice, video, chat and presence features. The application is called sip:phone and is a mobile app for iOS and Android.

The clients are fully brandable to the customer’s corporate identity. They are not part of the standard delivery and need to be licensed separately. This handbook discusses the mobile client in details.

18.2.1 Zero Config Launcher

Part of the mobile apps is a mechanism to sign up to the service via a 3rd party website, which is initiated on the login screen and rendered within the app. During the sign-up process, the 3rd party service is supposed to create a new account and subscriber in Sipwise C5 (e.g. automatically via the API) and provide the end user with the access credentials.

The mobile apps come with a zero config mechanism to simplify the end-customer log in using these credentials (especially ruling out the need to manually enter them). It makes it possible to deliver the access credentials via a side channel (e.g. Email, SMS) packed into a URL. The user just clicks the URL, and it automatically launches the app with the correct credentials. The following picture shows the overall workflow.

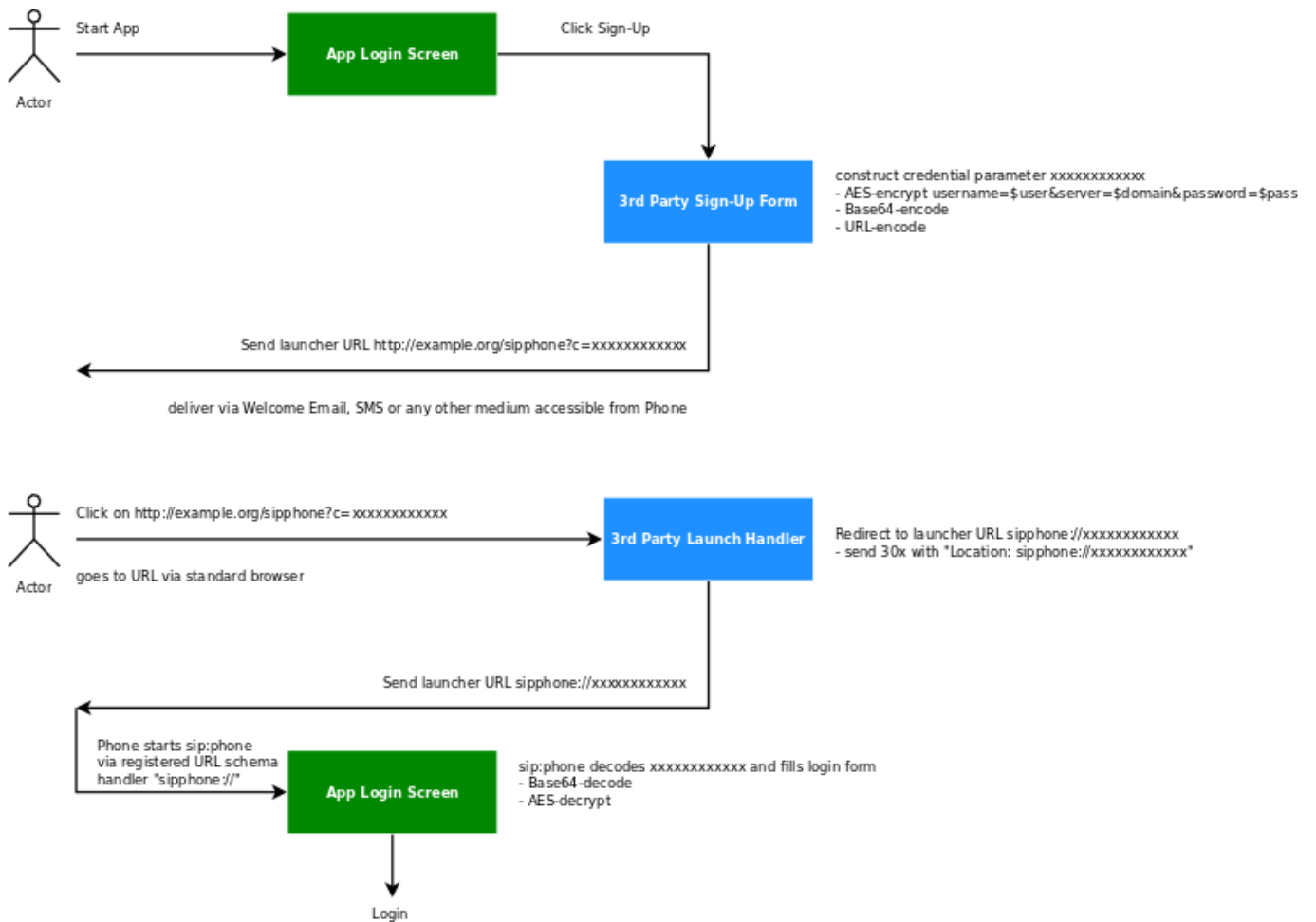

Figure 160: Provisioning Push Workflow

There are two components provided by a 3rd party system. One is the *3rd Party Sign-Up Form*, and the other is the *3rd Party Launch Handler*. The purpose of these components is to allow an end customer to open a link with the access credentials via the sip:phone app.

18.2.1.1 3rd Party Sign-Up Form

The 3rd Party Sign-Up Form is a website the app shows to the end user when he taps the sign-up link on the app *Login Screen*. There, the end customer usually provides his contact details like name, address, phone number and email address, etc. After validation, the website creates an account and a subscriber in Sipwise C5 via the API.

After successfully creating the account and the subscriber, this site needs to construct a specially crafted URL, which is sent back to the end customer via a side channel. Ideally, this channel would be an SMS if you want to verify the end customer's mobile number, or an email if you want to check the email address.

The sip:phone app registers a URL schema handler for URLs starting with `sipphone://`. If you start such a link, the app performs a Base64 decoding of the string right after the `sipphone://` prefix and then decrypts the resulting binary string via AES using the keys defined during the branding step. The resulting string is supposed to be

```
username=$user&server=$domain&password=$password&fsurl=$fsurl&fsttl=$fsttl&country=$country.
```

Therefore, the *3rd Party Sign-Up Form* needs to construct this string using the credentials defined while creating the subscriber via Sipwise C5 API, then encrypt it via AES, and finally perform a Base64 encoding of the result.

The parameters of the string are as follows:

- username: The SIP username for the login (e.g. *testuser*)
- password: The SIP password for the login (e.g. *testpass*)
- server: The server string containing either the IP address or a domain resolving via DNS SRV or A records to the load-balancer IP of the deployment (e.g. *sip.example.org*)
- fsurl: The filesharing URL for the apps to upload data (e.g. *https://sip.example.org:1446/rtc/fileshare/uploads*)
- fsttl: The number of seconds a shared file is valid by default (e.g. *1209600* for 14 days)
- country: The ISO country code for the app to normalize phone numbers (e.g. *de* for Germany)

An example Perl code performs encoding of such a string. The AES key and initialization vector (`$key` and `$iv`) are the standard values of the sip:phone app and should work until you specified other values during the branding process.

```
#!/usr/bin/perl -w
use strict;
use Crypt::Rijndael;
use MIME::Base64;
use URI::Escape;

my $key = 'iBmTдавJ8joPW3HO';
my $iv = 'tww211Qe6cmywrp3';

my $plain = do { local $/; <> };
# pkcs#5 padding to 16 bytes blocksize
my $pad = 16 - (length $plain) % 16;
```

```

$plain .= pack('C', $pad) x $pad;

my $cipher = Crypt::Rijndael->new(
    $key,
    Crypt::Rijndael::MODE_CBC()
);
$cipher->set_iv($iv);
my $encrypted = $cipher->encrypt($plain);
# store b64-encoded string and print to STDOUT
my $b64 = encode_base64($encrypted, '');
print $b64, "\n";
# print to STDOUT using URL escaping also
print uri_escape($b64), "\n";

```

This snippet takes a string from STDIN, encrypts it via AES, encodes it via Base64 and sends the result to STDOUT. It also writes the second line with the same string, but this time, the URL is escaped. To test it, you would run it as follows on a shell, granted it's stored at /path/to/encrypt.pl.

```

echo -n 'username=testuser&server=example.org&password=testpass&furl=https://example.org ↵
:1446/rtc/fileshare/uploads&fsttl=3600&country=at' \
| /path/to/encrypt.pl

```

This command would result in the output strings like `CI8VN8toaE40w8E4OH2rAuFj3Qev9QdLI/Wv/VaBCVK2yNkBZjxE9eafXkkrQfmYdeu01PquS5P40zhUq` and like `CI8VN8toaE40w8E4OH2rAuFj3Qev9QdLI%2FWv%2FVaBCVK2yNkBZjxE9eafXkkrQfmYdeu01PquS5P40zhUq`. The sip:phone can use the former string to automatically fill in the login form of the Login Screen if started via a Link like `sipphone://CI8VN8toaE40w8E4OH2rAuFj3Qev9QdLI/Wv/VaBCVK2yNkBZjxE9eafXkkrQfmYdeu01PquS5P40zhUq`.

Here is the same code in PHP.

```

#!/usr/bin/php
<?php
$key = "iBmTдавJ8joPW3HO";
$iv = "tww21lQe6cmwvrp3";

$clear = fgets(STDIN);
$cipher = fnEncrypt($clear, $key, $iv);

echo $cipher, "\n";
echo urlencode($cipher), "\n";

function fnEncrypt($clear, $key, $iv) {
    $pad = 16 - strlen($clear) % 16;
    $clear .= str_repeat(pack('C', $pad), $pad);
    return rtrim(base64_encode(mcrypt_encrypt(
        MCRYPT_RIJNDAEL_128, $key, $clear,

```



```

        MCRYPT_MODE_CBC, $iv)), "\0");
    }
    ?>

```

Similar to the Perl code, you can call it like this:

```

echo -n 'username=testuser&server=example.org&password=testpass&furl=https://example.org ↵
:1446/rtc/fileshare/uploads&fsttl=3600&country=at' \
| /path/to/encrypt.php

```

However, a URL with the `sipphone://` schema is not displayed as a link in an SMS or an Email client and thus can not be clicked by the end customer, so you need to make a detour via a regular `http://` URL. To do so, you need a *3rd Party Launch Handler* to trick the phone to open such a link.

Therefore, that the *3rd Party Sign-Up Form* needs to return a link containing a URL pointing to the *3rd Party Launch Handler* and pass the URL escaped string gathered above to the client via an SMS or an Email. Since it is the regular `http://` link, it is clickable on the phone and can be launched from virtually any client (SMS, Email, etc.), which correctly renders an HTML link.

A possible SMS sent to the end customer (via the phone number entered in the sign-up form) could, therefore, look as follows (trying to stay below 140 chars).

```

http://example.org/p?c=CI8VN8toaE40w8E4OH2rAuFj3Qev9QdLI
%2FWv%2FVaBCVK2yNkBZjxE9eafXkkrQfmYdeu01PquS5P40zhUq8Mfjg%3D%3D to launch sipphone

```

An HTML Email could look like this:

```

Welcome to Example.org,
<a href="http://www.example.org/sipphone?c=CI8VN8toaE40w8E4OH2rAuFj3Qev9QdLI
%2FWv%2FVaBCVK2yNkBZjxE9eafXkkrQfmYdeu01PquS5P40zhUq8Mfjg%3D%3D">
click here
</a> to log in.

```

That way, you can do both: verify the contact details of the end customer, and send the end customer the login credentials in a secure manner.

18.2.1.2 3rd Party Launch Handler

The URL `http://www.example.org/sipphone` mentioned above can be any simple script, and its sole purpose is to send back a 301 Moved Permanently or 302 Moved Temporarily with a `Location: sipphone://xxxxxxxxxxxx` header to tell the phone to open this link via the sip:phone app. The `xxxxxxxxxxxx` is the plain (non-URL-escaped) string generated by the above script.

An example CGI script performing this task follows.

```
#!/usr/bin/perl -w
use strict;
use CGI;

my $q = CGI->new;
my $c = $q->param('c');
print CGI::redirect("sipphone://$c");
```

The script simply takes the URL parameter `c` from the URL `http://www.example.org/sipphone?c=CI8VN8toaE40w8E40H` crafted above and puts its content into a `Location` header using the `sipphone://` schema, and finally sends a `301 Moved Permanently` back to the phone.

The phone follows the redirect by opening the URL using the `sip:phone` app, which in turn decrypts the content and fills in the login form.

Note

Future versions of Sipwise C5 will be shipped with this launch handler integrated into the system. Up until and including the version mr8.5.9, this script needs to be installed on any webserver manually.

18.2.2 Mobile Push Notification

The *mobile push* functionality provides the remote start of a mobile application on incoming calls via the Google FCM or the Apple APNS notification services. It enables you to offer your subscribers a modern and convenient service on mobile devices.

**Caution**

Although suspending an application on a phone and waking it up via the mobile push notification service extends battery life, the whole mobile push notification concept is the best effort framework provided by Apple and Google for iOS and Android respectively, and therefore does not guarantee 100% reliability.

18.2.2.1 Architecture

If the *mobile push* functionality is enabled and there are no devices registered for a subscriber, the call-flow looks as follows.

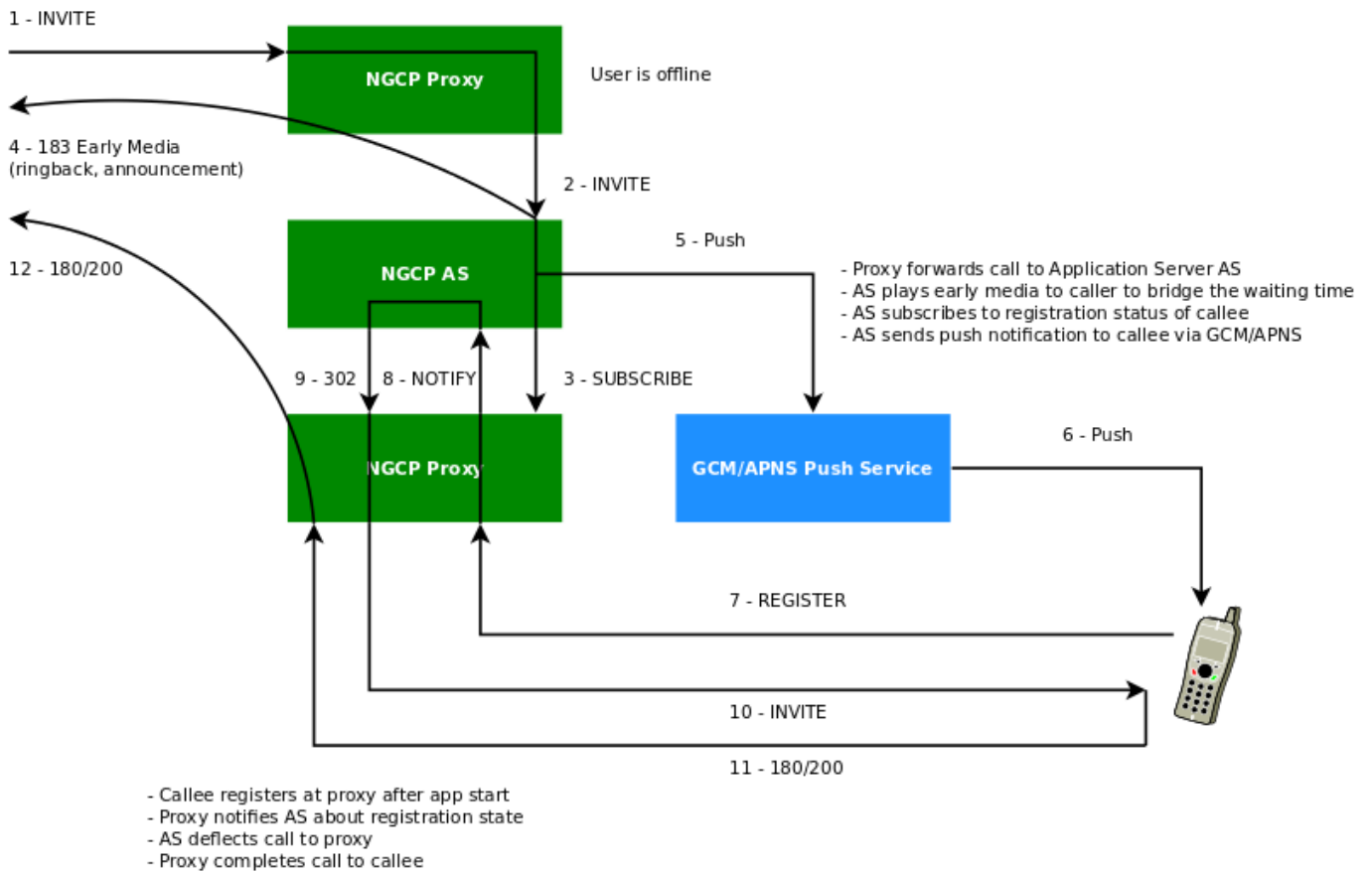

Figure 161: Mobile Push Workflow

1. The caller sends INVITE to proxy
2. The callee is offline, proxy forwards the call to AS (application server)
3. AS subscribes to the callee's registration events on proxy
4. AS sends early media to the caller as a feedback, as the call initiation process might take a while
5. AS sends the push request to FCM/APNS service
6. FCM/APNS service delivers the push request to the callee
7. The callee accepts the push request and confirms the mobile application start (unattended on Android), then the mobile application registers to proxy
8. Proxy sends registration notification to AS
9. AS deflects the call back to proxy
10. Proxy sends INVITE to the callee
11. The callee accepts the call
12. The response is sent back to the caller. Hence, the call setup is completed

In the case of a time-out (no registration notification within a particular time), the application server rejects the call request with an error.

18.2.2.2 The Configuration Checklist

Follow this checklist to make sure you've completed all the steps. If you miss anything, the service may not work as expected.

Name	Description	Link
Obtain a trusted SSL certificate from a CA	Required for either application	Section 18.2.2.3
Create an Apple developer account and enable the push notification service	For iOS mobile application	Section 18.2.2.4
Obtain the Apple certificate for the app	For iOS mobile application	Section 18.2.2.5
Obtain the API key for the app from Google	For Android mobile application	Section 18.2.2.6
Provide the required information to developers	It is required to make beta builds and publish the apps	Section 18.2.2.7
Adjust the configuration	Adjust the config.yml file and apply the changes (usually performed by Sipwise)	Section 18.2.2.8
Recheck your DNS Zone configuration	Check that the DNS Zone is correctly configured	Section 18.2.2.9
Add DNS SRV records	Create specific DNS SRV records for SIP and XMPP services	Section 18.2.2.10
Check NTP configuration	Ensure that all your servers show exact time	Section 18.2.2.11
Enable Apple/Google Mobile Push in the Admin Panel	It can be enabled for a domain or separate subscribers	Section 18.2.2.12
Configure a mobile application	Check that subscribers can easily install and use your application	Section 18.2.2.13

18.2.2.3 Obtain the Trusted SSL Certificate

A *trusted* SSL certificate is required, and we suggest obtaining it before starting the configuration.

The mobile application uses respective iOS/Android libraries to establish a secure TLS connection with certain Sipwise C5 services, such as SIP/XMPP/pushd(https). A *signed* SSL certificate is required to guarantee the security of this connection.

Any Certificate Authority (CA) such as Verisign and others can provide you with the required trusted SSL certificate (a certificate and the key files) which you will use in the configuration below.

18.2.2.4 Create an Apple Account and Enable the Push Notification Service

Below is a brief instruction on how to create an Apple account and enable the Push Notification Service in it. You may need to perform additional steps depending on your project.

Note

You may only create an Apple account (step 1 below) and enroll into the Apple Developer Program (step 2 below) and Sipwise developers will do the rest. Still, you can perform all the steps by yourself.

1. Create an Apple developer account to get the Apple ID for your company. For this, go to <https://developer.apple.com/account>
2. Enroll in the Apple Developer Program. It is required to configure push notifications as you will need a push notification certificate for your App ID, which requires the Apple Developer Program membership. Go to <https://developer.apple.com/programs> for more details.
3. Register an App ID:
 - Sign into <https://developer.apple.com/account>.

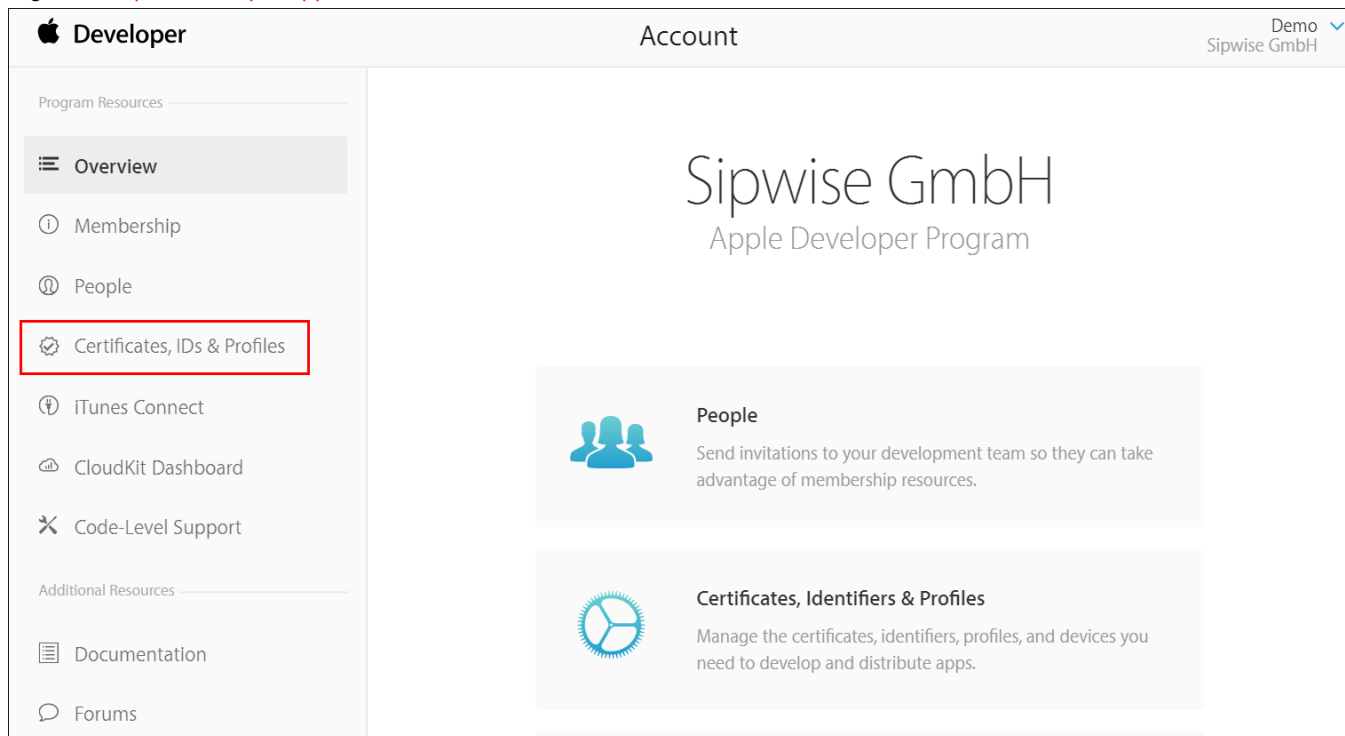

- Click *Certificates, IDs & Profiles*.

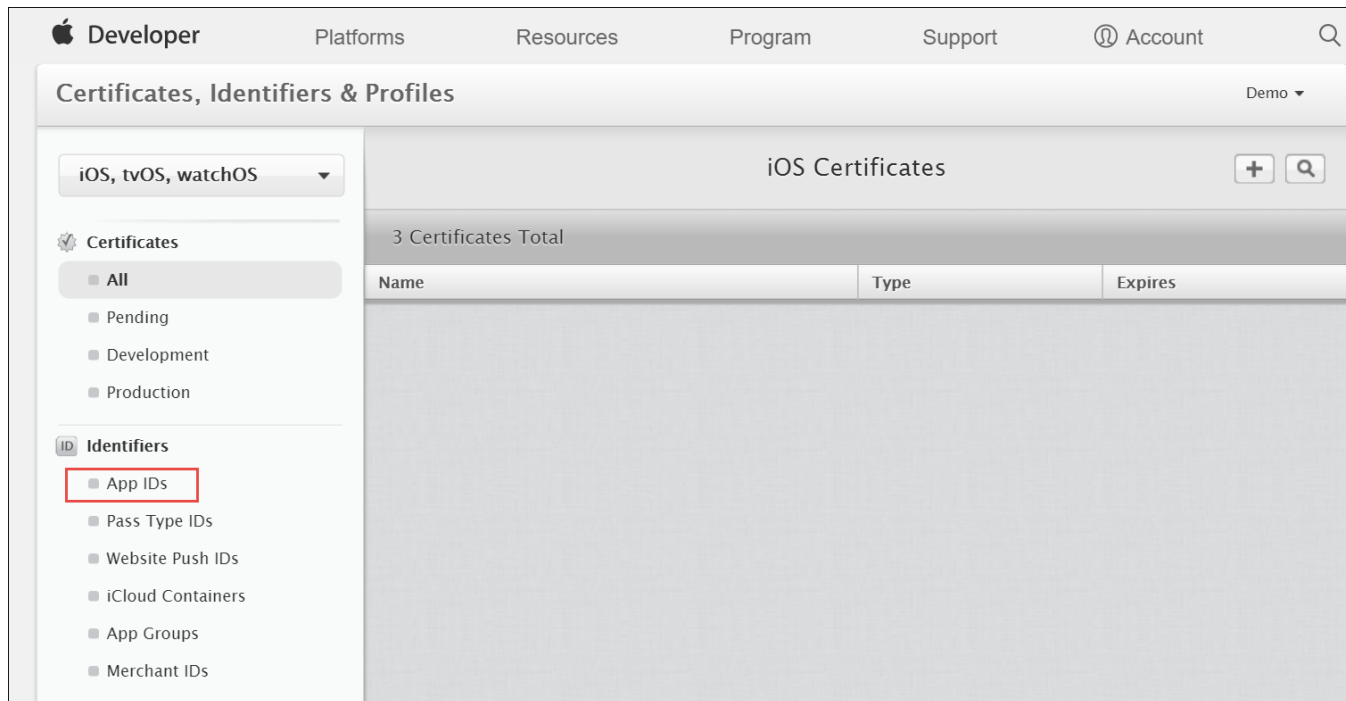

- Under *Identifiers*, select *App IDs*.

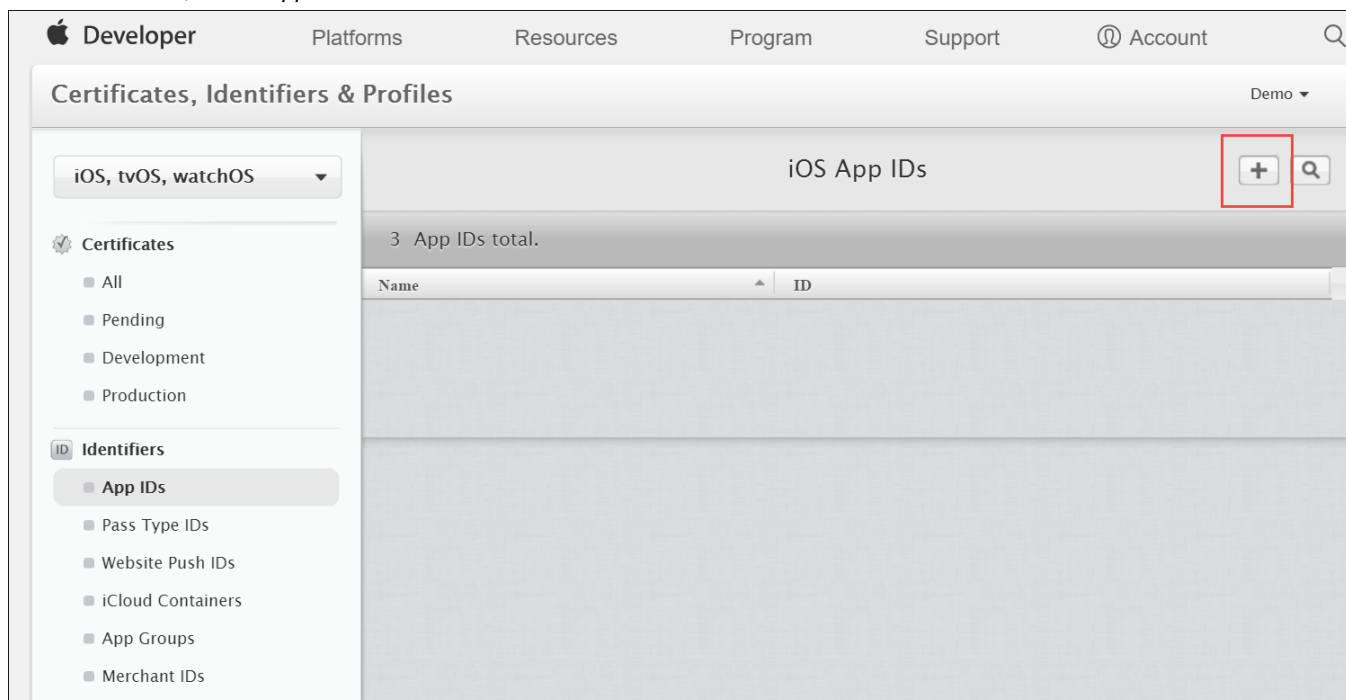

- Click the *Add* button (+) in the upper-right corner.

ID

Registering an App ID

The App ID string contains two parts separated by a period (.) — an App ID Prefix that is defined as your Team ID by default and an App ID Suffix that is defined as a Bundle ID search string. Each part of an App ID has different and important uses for your app. [Learn More](#)

App ID Description

Name:

You cannot use special characters such as @, &, *, ', "

- Enter a name for the App ID in the *App ID Description* block. This helps you identify the App ID later.

- Apple TV
- Apple Watch
- iPad
- iPhone
- iPod Touch

Provisioning Profiles

- All
- Development
- Distribution

App ID Prefix

Value: XD7GAT4I26 (Team ID)

App ID Suffix

Explicit App ID

If you plan to incorporate app services such as Game Center, In-App Purchase, Data Protection, and iCloud, or want a provisioning profile unique to a single app, you must register an explicit App ID for your app.

To create an explicit App ID, enter a unique string in the Bundle ID field. This string should match the Bundle ID of your app.

Bundle ID:

We recommend using a reverse-domain name style string (i.e., com.domainname.appname). It cannot contain an asterisk (*).

Wildcard App ID

This allows you to use a single App ID to match multiple apps. To create a wildcard App ID, enter an asterisk (*) as the last digit in the Bundle ID field.

- Select *Explicit App ID* and enter the app's bundle ID in the *Bundle ID* field. Note that an explicit App ID exactly matches the bundle ID of an app you are building — for example, com.example.push. An explicit App ID can *not* contain an asterisk (*).

App Services

Select the services you would like to enable in your app. You can edit your choices after this App ID has been registered.

Enable Services:

- App Groups
- Associated Domains
- Game Center
- In-App Purchase
- Inter-App Audio
- Wallet
- Push Notifications
- Personal VPN

- In the App Services section enable Push Notifications. Click *Continue* to submit the form

ID Confirm your App ID.

To complete the registration of this App ID, make sure your App ID information is correct, and click the submit button.

App ID Description: **com example push**

Identifier: **XD7GAT4I26**

Data Protection: ● Disabled

Game Center: ● **Enabled**

iCloud: ● Disabled

In-App Purchase: ● **Enabled**

Inter-App Audio: ● Disabled

Passbook: ● Disabled

Push Notifications: ● **Enabled**

- Click *Submit* to create the App ID.

18.2.2.5 Obtain an Apple SSL Certificate and a Private Key

1. Create a CSR (Certificate Signing Request):

- Sign into <https://developer.apple.com/account/ios/certificate>.

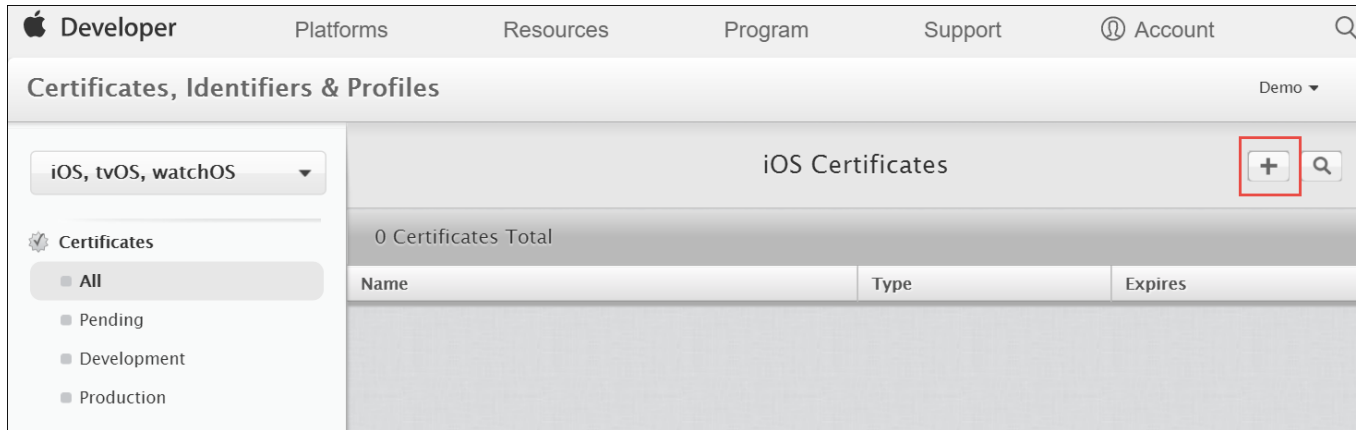

- Click the *Add* button (+) in the upper-right corner.

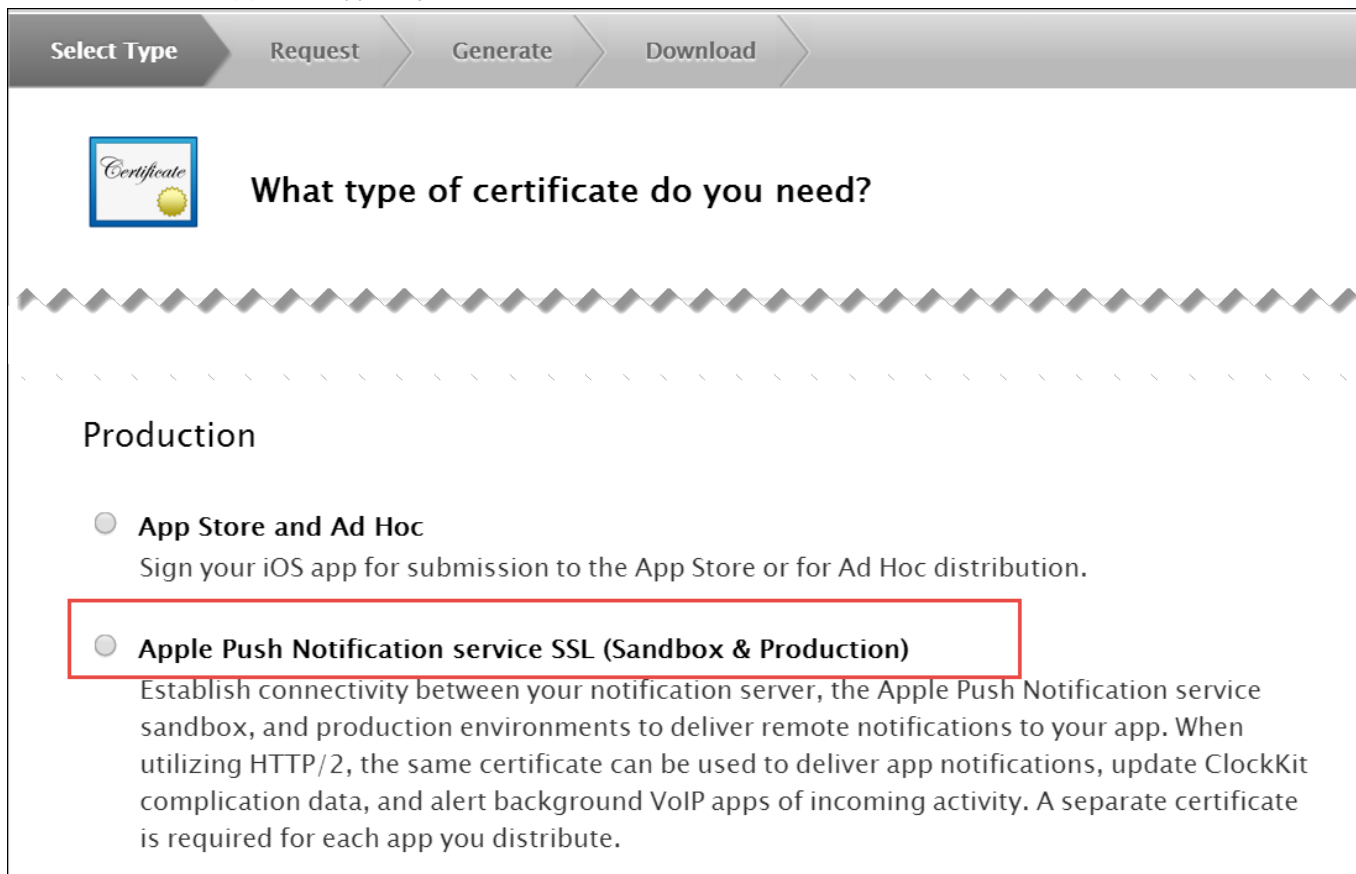

- Select *Apple Push Notification service SSL (Sandbox & Production)* as the certificate type and click *Continue*.

Select Type Request Generate Download



Which App ID would you like to use?

All App IDs that you want to enable for remote notifications require their own Apple Push Notification service SSL certificate. The App ID-specific SSL certificate allows your server to connect to the Apple Push Notification service. Note that only explicit App IDs with a specific Bundle Identifier can be used to create an Apple Push Notification service SSL certificate.

Select an App ID for your Apple Push Notification service SSL Certificate (Sandbox & Production)

App ID:

- Select your App ID and click *Continue*.

Select Type Request Generate Download



About Creating a Certificate Signing Request (CSR)

To manually generate a Certificate, you need a Certificate Signing Request (CSR) file from your Mac. To create a CSR file, follow the instructions below to create one using Keychain Access.

Create a CSR file.

In the Applications folder on your Mac, open the Utilities folder and launch Keychain Access.

Within the Keychain Access drop down menu, select Keychain Access > Certificate Assistant > Request a Certificate from a Certificate Authority.

- In the Certificate Information window, enter the following information:
 - In the User Email Address field, enter your email address.
 - In the Common Name field, create a name for your private key (e.g., John Doe Dev Key).
 - The CA Email Address field should be left empty.
 - In the "Request is" group, select the "Saved to disk" option.
- Click Continue within Keychain Access to complete the CSR generating process.

- Read the information about creating a CSR.
- Follow the instructions to create a CSR using Keychain Access in MAC.

Note

If you do not have access to a Mac, you can still create a CSR in Linux or Windows using OpenSSL, for example.

2. Get the Certificate and Private Key

- When you have the CSR file return to the browser and click *Continue*.

Select TypeRequestGenerateDownload



Generate your certificate.

When your CSR file is created, a public and private key pair is automatically generated. Your private key is stored on your computer. On a Mac, it is stored in the login Keychain by default and can be viewed in the Keychain Access app under the "Keys" category. Your requested certificate is the public half of your key pair.

Upload CSR file.
Select .certSigningRequest file saved on your Mac.

Choose File...

- Click *Choose File...* in your browser.

Select Type Request Generate Download



Generate your certificate.

When your CSR file is created, a public and private key pair is automatically generated. Your private key is stored on your computer. On a Mac, it is stored in the login Keychain by default and can be viewed in the Keychain Access app under the "Keys" category. Your requested certificate is the public half of your key pair.

Upload CSR file.
Select .certSigningRequest file saved on your Mac.

CertificateSigningRequest.certSigningRequest

- Select the CSR file you just created and saved and click *Continue*.

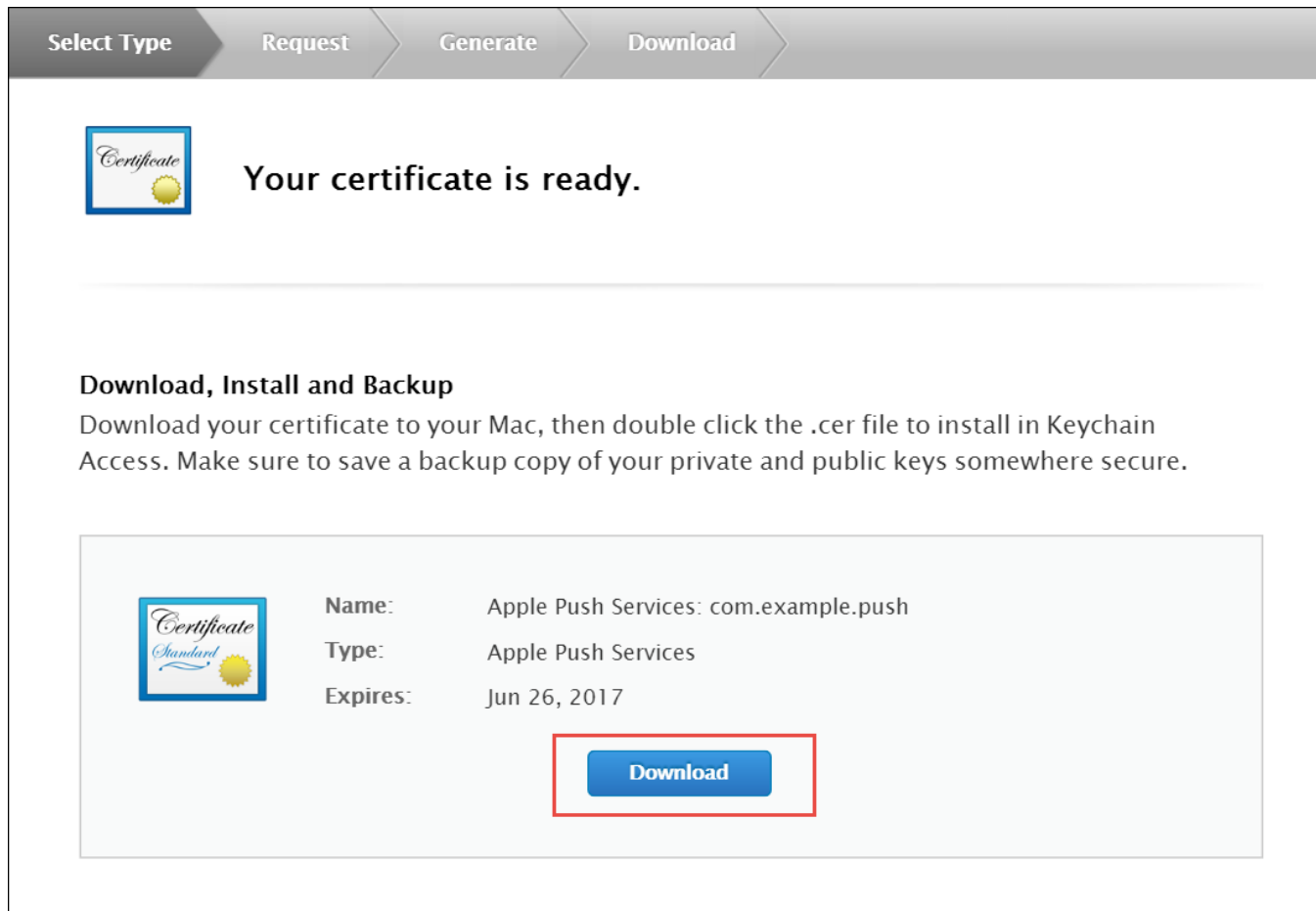

Select Type Request Generate Download

 **Your certificate is ready.**

Download, Install and Backup
Download your certificate to your Mac, then double click the .cer file to install in Keychain Access. Make sure to save a backup copy of your private and public keys somewhere secure.

 **Name:** Apple Push Services: com.example.push
Type: Apple Push Services
Expires: Jun 26, 2017

[Download](#)

- Click *Download* to download the certificate (give it the **aps.cer** name).
- Open the downloaded certificate file (it should automatically be opened in Keychain Access, otherwise open it manually in Keychain Access).
- Find the certificate you just opened/imported in Keychain Access.
- Expand the certificate to show the Private Key.
- Select only the Private Key portion of the certificate, right-click on it and select *Export "Common Name"...* from the menu.
- Choose a location (e.g. Desktop) and filename to export the .p12 file to and click *Save*.
- **Optionally** pick a password for the .p12 file to protect its private key contents and click *OK*. (You will then need to enter your log-in password to permit the export).

3. Generate a PEM file from the p12 file:

- Open up your terminal and run the following commands to create a PEM file from the p12 file (If you input a password for the p12 file, you will need to enter it here):

```
cd ~/Desktop
openssl x509 -in aps.cer -inform der -out PushChatCert.pem
openssl pkcs12 -in PushChatCert.p12 -out PushCertificate.pem -nodes -clcerts
openssl pkcs12 -nocerts -out PushChatKey.pem -in PushChatKey.p12
```

18.2.2.6 Obtain the API Key for the App from Google

You can use Google Firebase Cloud Messaging (FCM) to send push notifications to your subscribers with Android-based mobile devices. Google Cloud Messaging is a free service that acts as an intermediary between Sipwise C5 and devices of your subscribers. Google's Cloud Connection Server (CCS), a part of GCP, manages the persistent connections with mobile devices to deliver your push notifications.

While communicating with CCS, Sipwise C5 identifies itself using an API key. To get it, follow the steps below.

1. Create a new project in the Google APIs Console page. For this go to code.google.com/apis/console.

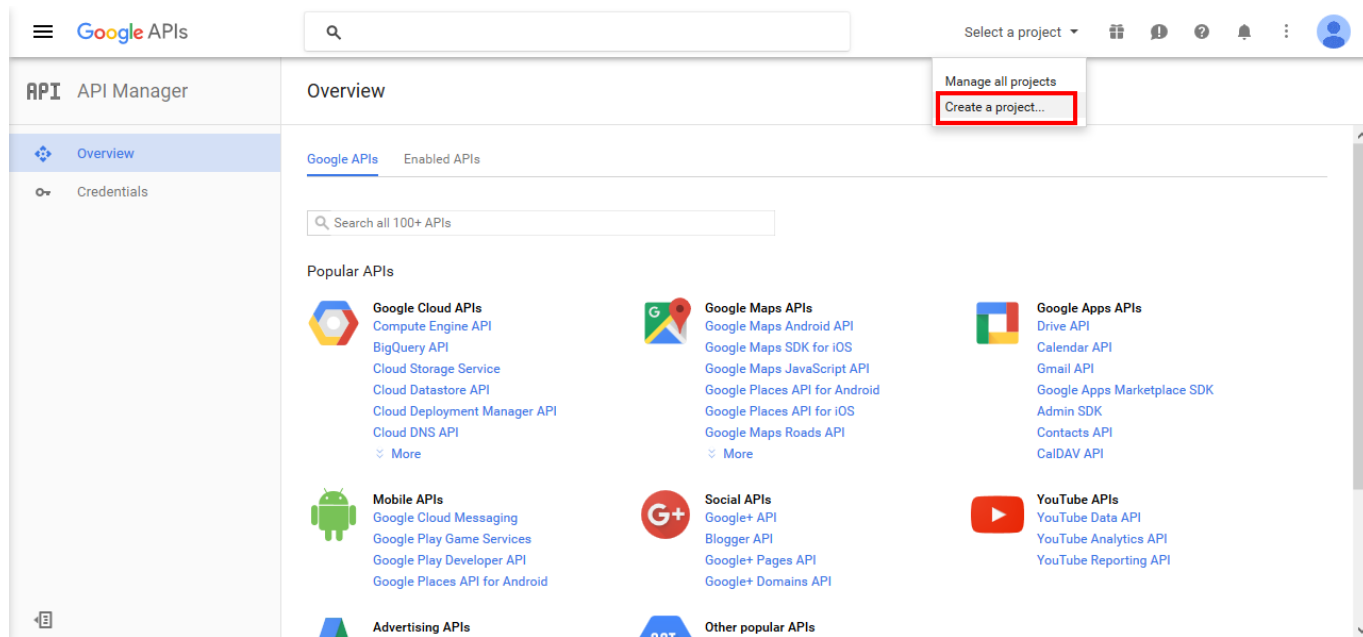

2. Click *Create a Project*.

review

le APIs Enab

Search all 100+ A

ilar APIs

- Google Cl
- Compute
- BigQuery
- Cloud Sto
- Cloud Dat
- Cloud Dep
- Cloud DNS
- More

New Project

Project name ?

Your project ID will be mychat-1320 ? [Edit](#)

[Show advanced options...](#)

Please email me updates regarding feature announcements, performance suggestions, feedback surveys and special offers.

Yes No

I agree that my use of any services and related APIs is subject to my compliance with the applicable [Terms of Service](#).

Yes No

[Create](#) [Cancel](#)

 **Mobile APIs**
Google Cloud Messaging

 **Social APIs**
Google+ API

3. Input the project name, agree with the *Terms of Service* and click *Create*.







API Manager

- Overview
- Credentials

Overview

Google APIs Enabled APIs (0)

Popular APIs

 Google Cloud APIs Compute Engine API BigQuery API Cloud Storage Service Cloud Datastore API Cloud Deployment Manager API Cloud DNS API More	 Google Maps APIs Google Maps Android API Google Maps SDK for iOS Google Maps JavaScript API Google Places API for Android Google Places API for iOS Google Maps Roads API More	 Google Apps APIs Drive API Calendar API Gmail API Google Apps Marketplace SDK Admin SDK Contacts API CalDAV API
 Mobile APIs Google Cloud Messaging Google Play Game Services Google Play Developer API Google Places API for Android	 Social APIs Google+ API Blogger API Google+ Pages API Google+ Domains API	 YouTube APIs YouTube Data API YouTube Analytics API YouTube Reporting API

4. Click *Google Cloud Messaging* on the Overview page.

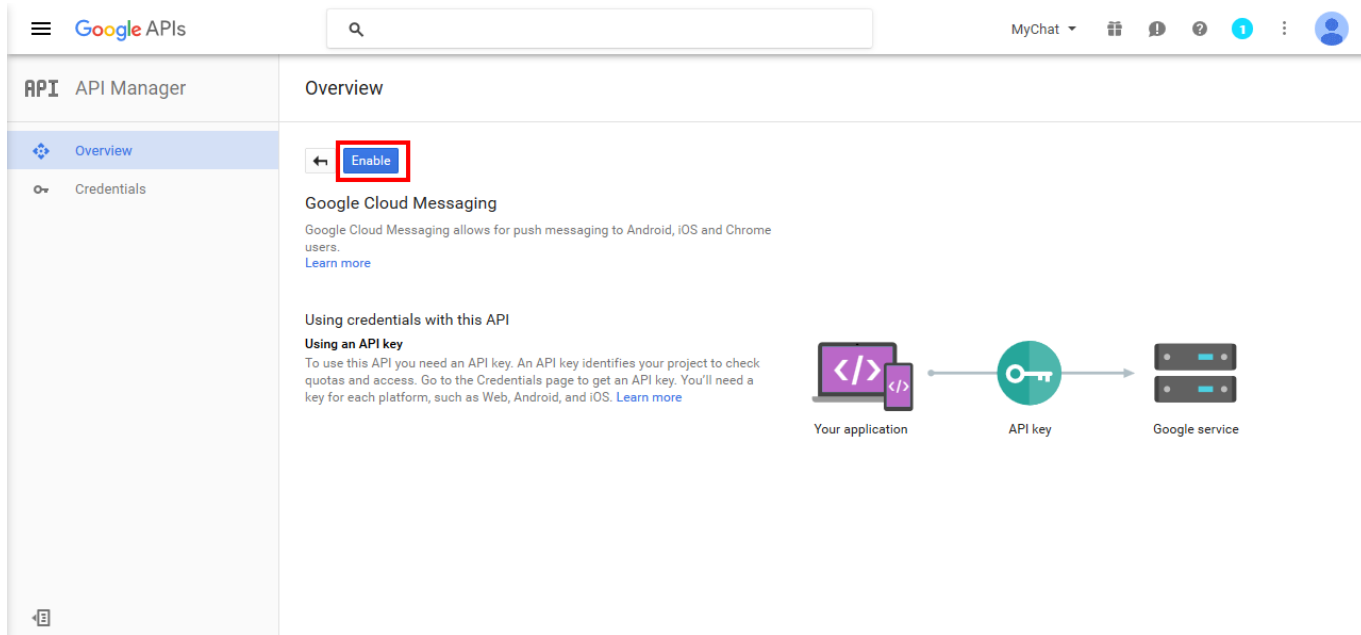

5. Click *Enable* for the Google Cloud Messaging.

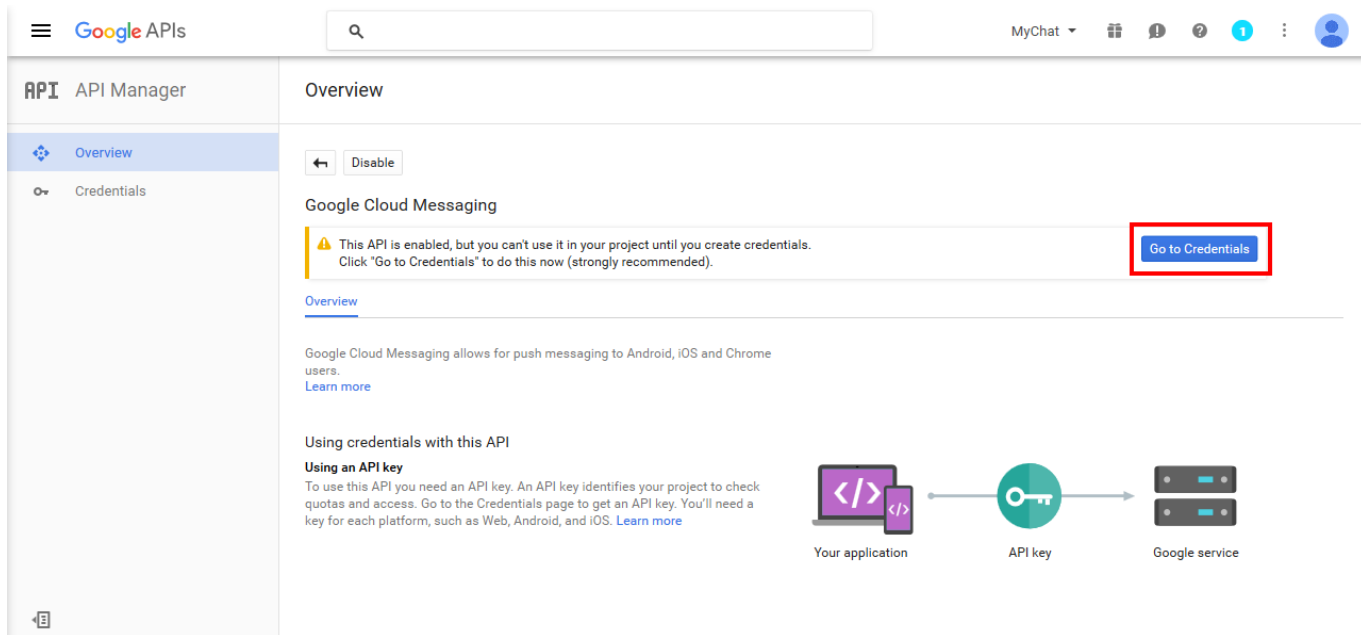

6. Click *Go to Credentials*.

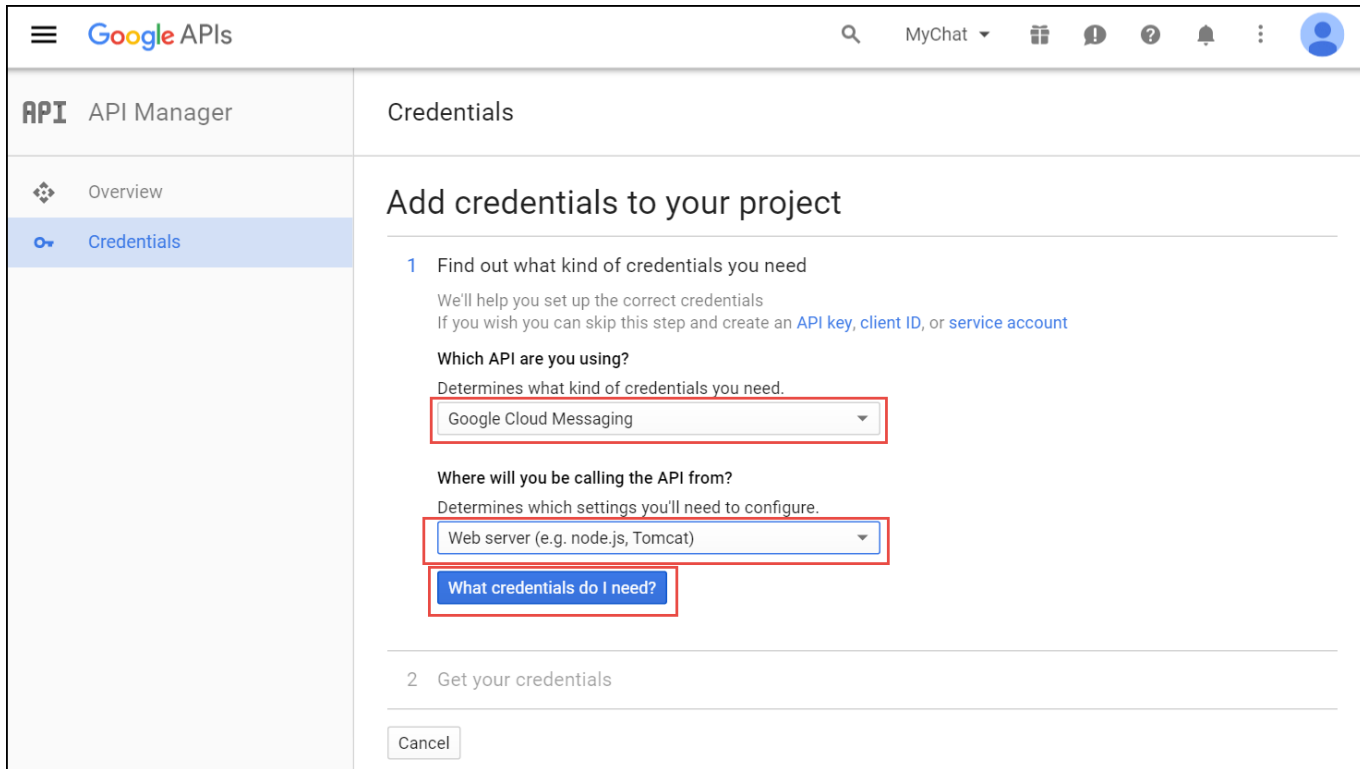

7. Select Google Cloud Messaging and Web Server from the corresponding lists and click *What credentials do I need?*

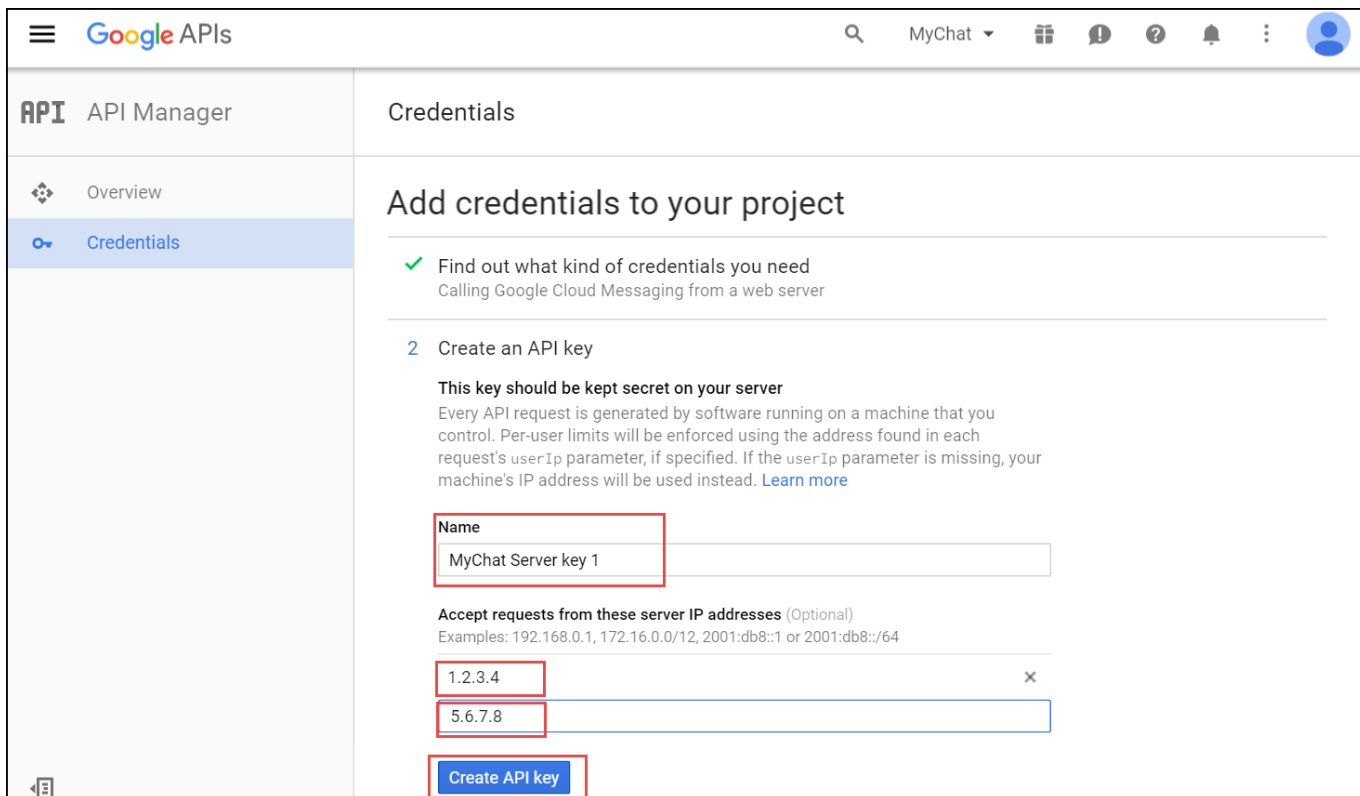

8. Adjust the API Key name and input the IP addresses of *all* your load balancers under *Accept requests from these server IP addresses*. Click *Create API key*.

Note

You may skip adding the IP addresses, otherwise list *ALL* your load balancers.

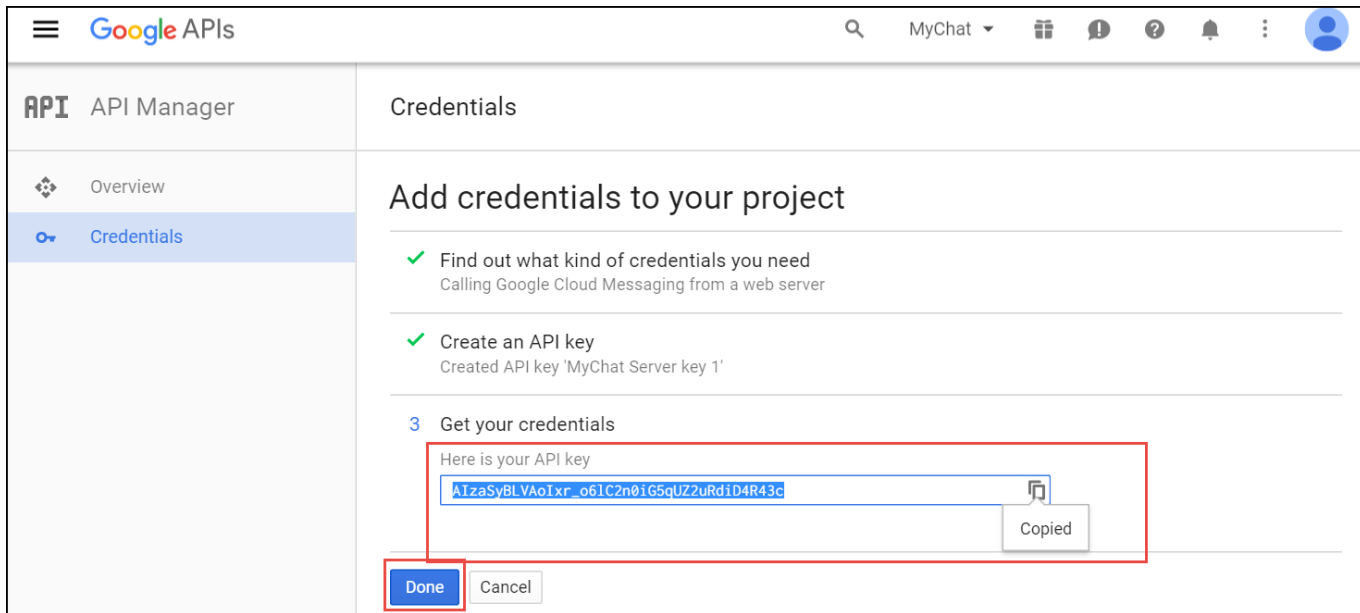

9. Copy your API key and click *Done*. Save the API key for future use.

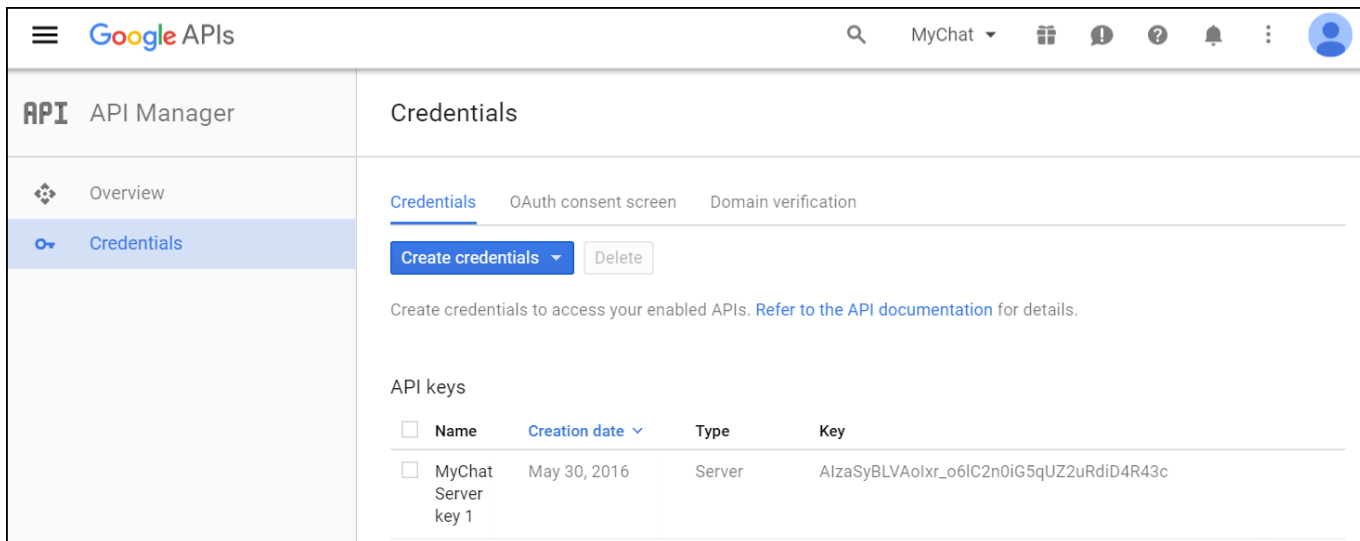

18.2.2.7 Provide the Required Information to Developers

Please, provide Sipwise developers with the following files and information so that they can make beta builds and submit the application to the App Store:

- Access to your Apple developer account
- The trusted SSL certificate and its private key
- The Apple SSL certificate and its private key

For the Android application, provide the following:

- Access to your Google developer account
- Google application API key

18.2.2.8 Adjust Sipwise C5 Configuration (Usually Performed by Sipwise)

1. Upload the Apple SSL certificate (**PushChatCert.pem**) and the private key (**PushChatKey.pem**) to `/etc/ngcp-config/ssl/`
2. Upload the trusted SSL certificate (**CAsigned.crt**) and the private key (**CAsigned.key**) to `/etc/ngcp-config/ssl/`
3. Specify the corresponding paths and names in the pushd section of the config.yml file:

- apns: section (For iOS mobile application)
 - certificate: `'/etc/ngcp-config/ssl/PushChatCert.pem'`
 - enable: yes
 - key: `'/etc/ngcp-config/ssl/PushChatKey.pem'`
- enable: yes
- android: section (for Android mobile application)
 - enable: yes
 - key: `'google_server_api_key_here'`
- ssl: yes
- sslcertfile: `/etc/ngcp-config/ssl/CAsigned.crt`
- sslcertkeyfile: `/etc/ngcp-config/ssl/CAsigned.key`

You can find an example of `/etc/ngcp-config/config.yml` configuration in the [config.yml overview section](#).

4. Apply your changes:

```
ngcpcfg apply 'enabled the backup feature.'  
ngcpcfg push all
```

18.2.2.9 Recheck Your DNS Zone Configuration

Check that your **NS** and **A** DNS records are correctly configured.

Let's consider the following example: * the load-balancers have the `lb01a.example.com` and the `lb01b.example.com` names * the shared name is `lb01.example.com` and the shared IP address is `1.1.1.1` * the service name is `voipservice.example.com`

The following DNS records must be present:

Server Name	Record type	IP Address
lb01a.example.com	A	1.2.3.4
lb01b.example.com	A	5.6.7.8
lb01.example.com	A	1.1.1.1
voipservice.example.com	A	1.1.1.1

18.2.2.10 Add SRV Records to DNS

Add at least one record for each service: **xmpp-server**, **xmpp-client**, **sips**.

A regular SRV record has the following form:

```
_service._proto.name. TTL class SRV priority weight port target
```

- **service**: the symbolic name of the service (xmpp-server, xmpp-client, sips).
- **proto**: the transport protocol of the desired service (TCP).
- **name**: the domain name (ending in a dot).
- **TTL**: standard DNS time to live field.
- **class**: the standard DNS class field (this is always IN).
- **priority**: the priority of the target host (lower value means more preferred).
- **weight**: a relative weight for records with the same priority (the higher the value, the more requests will be sent).
- **port**: the TCP or UDP port of the service.
- **target**: the canonical hostname of the machine providing the service (ending in a dot).

Here are examples of the SRV records:

```
_xmpp-server._tcp.voipservice.example.com. 18000 IN SRV 10 50 5269 voipservice.example.com.  
_xmpp-client._tcp.voipservice.example.com. 18000 IN SRV 10 50 5222 voipservice.example.com.  
_sips._tcp.voipservice.example.com. 18000 IN SRV 10 100 5061 voipservice.example.com.
```

You can always check whether the required SRV records are configured by executing the following commands:

```
dig SRV _xmpp-client._tcp.voipservice.example.net  
dig SRV _xmpp-server._tcp.voipservice.example.net  
dig SRV _sips._tcp.voipservice.example.net
```

18.2.2.11 Check NTP Configuration

We strongly suggest that the clocks of all the nodes within the platform are synchronized. To ensure this, check that the NTP service is correctly configured on all your Sipwise C5 servers and works reliably. Execute the following command for quick test of time synchronization:

```
timedatectl
```

If the current node synchronizes with an NTP server, this server will be marked by *NTP service: active*.

Execute the following command to get the NTP service status:

```
timedatectl timesync-status
```

18.2.2.12 Enable Apple/Google Mobile Push

It can be enabled for a domain or separate subscribers in the Admin Panel.

To enable the service for a domain:

1. Go to *Settings*→*Domains* and click on the *Preferences* button of the domain you want to enable Apple/Google Mobile Push for.
2. Go to the *Internals* group and enable the **mobile_push_enable** parameter.

Internals				
	Attribute	Name	Value	
?	force_inbound_calls_to_peer	Force inbound calls to peer	<input type="checkbox"/>	✎ Edit
?	mobile_push_enable	Enable Apple/Google Mobile Push	<input checked="" type="checkbox"/>	✎ Edit
?	ip_header	IP Header Field		

18.2.2.13 Perform Tests

Perform tests when the application is available:

1. Download and install the application.
2. Open the application and input your registration username in the `username@domain.name` format and password.
3. Review the quality of application branding.

4. Make test calls.
5. Test the presence functionality.
6. Test the chat and group chat.
7. Test messaging.
8. Test the sharing functionality (e.g. pictures, video and voice messages and maps).
9. Check the application phone book integration with the phone's one

Make sure that the subscribers can start using your services in the easiest possible way.

18.3 Lawful Interception

18.3.1 Introduction

The Sipwise C5, as a communications platform carrying voice, fax and messaging data has to provide means for lawful interception of the content of communication by third party entities. Those Law Enforcement Agencies (LEAs) have to be able to connect to Sipwise C5 platform in a standardized way—ETSI, 3GPP and other organisations define the interface (and data exchange) between telecommunication operators and LEAs.

High level overview of lawful interception is shown in the following figure:

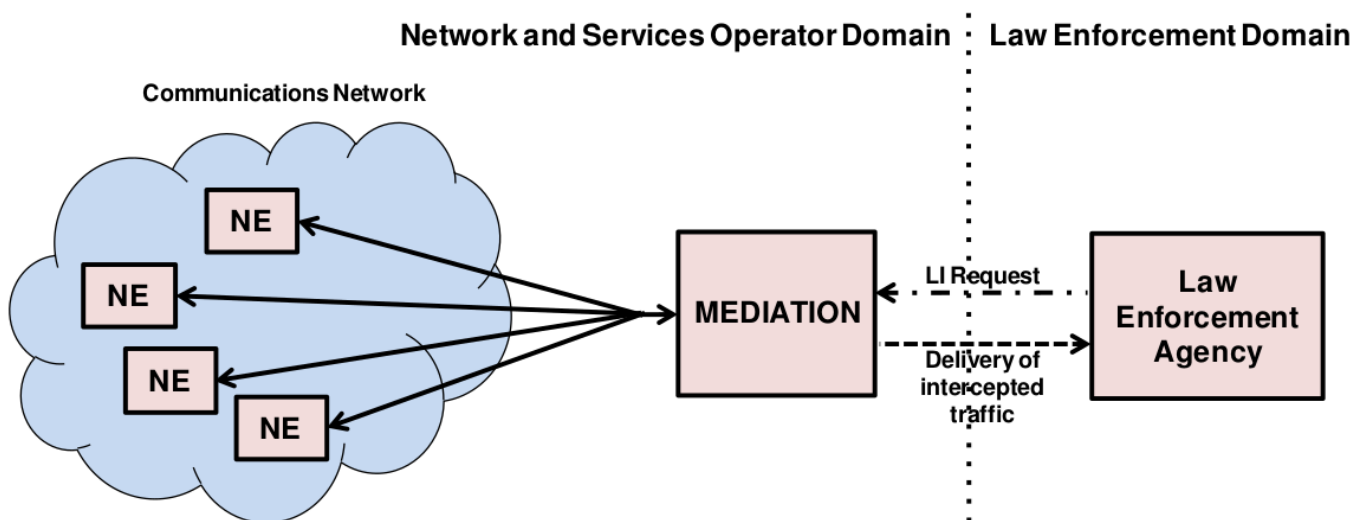

Figure 162: LI: High Level Overview

Main interfaces of lawful interception according to ETSI standard:

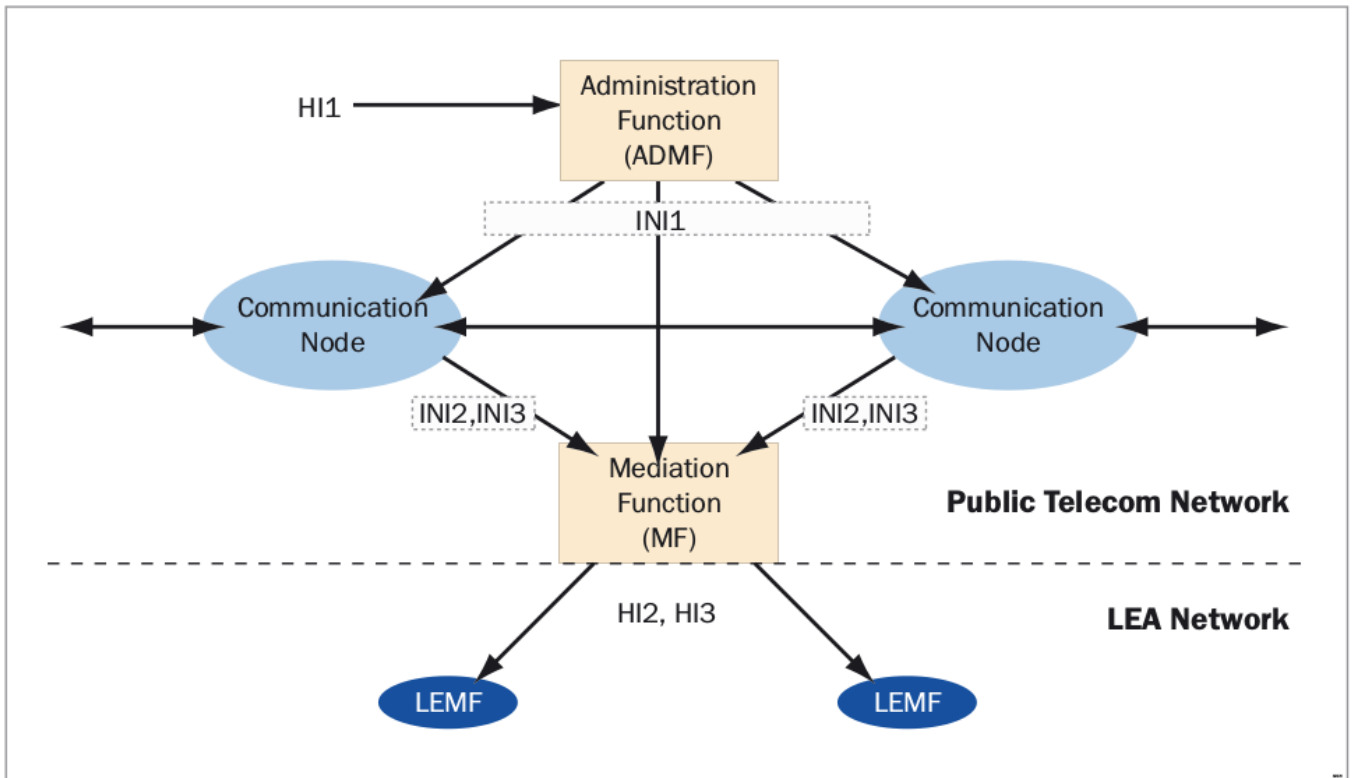

Figure 163: LI: ETSI Interfaces

18.3.1.1 Terms and Abbreviations

Content of Communication (CC)

Information exchanged between two or more users of a telecommunications service, excluding Intercept Related Information.

Note

This includes information which may, as part of some telecommunications service, be stored by one user for subsequent retrieval by another.

CC Internal Interception Function (CC-IIF)

The CC-IIF shall cause the CC, specified by the CCTF, via the CCCI to be duplicated and passed to the MF.

Content of Communication Control Interface (CCCI)

Carries controls information from the CCTF to the CC-IIF.

CC Trigger Function (CCTF)

The purpose of the CCTF is to determine the location of the CC-IIF device associated to the target CC traffic, and to control the CC-IIF via the CCCI interface.

Content of Communication Trigger Interface (CCTI)

Carries trigger information from the IRI-IIF to the CCTF.

Handover Interface (HI)

Physical and logical interface across which the interception measures are requested from an operator, and the results of interception are delivered from an operator to an LEMF.

Intercept Related Information (IRI)

Collection of information or data associated with telecommunication services involving the target identity, specifically call or service associated information or data (e.g. call identifier, unsuccessful call attempts) and location information.

Intercept Related Information Internal Interception Function (IRI-IIF)

The purpose of the IRI-IIF is to generate IRI information associated with sessions, calls, connections and any other information involving interception targets identified by Law Enforcement Agency (LEA) sessions.

Internal Network Interface (INI)

Network's internal interface between the Internal Intercepting Function and a mediation function.

Law Enforcement Agency (LEA)

Organization authorized, by a lawful authorization based on a national law, to request interception measures and to receive the results of telecommunications interceptions.

Law Enforcement Monitoring Facility (LEMF)

Law enforcement facility designated as the transmission destination for the results of interception relating to a particular interception subject.

Lawful Interception Administration Function (AF)

The AF ensures that an intercept request from a LEA for IRI or CC or both is provisioned for collection from the network, and subsequent delivery to the LEMF.

Lawful Interception Mediation Function (MF)

Mechanism which passes information between an access provider or network operator or service provider and a handover interface.

1. Firstly it receives information related to active intercepts from the IRI-IIF(s) and CC-IIF(s) within the service provider network.
2. Secondly correlates and formats that IRI and CC information in real time for delivery to the LEMF over the HI2 and HI3 handover Interfaces.

X1, X2 and X3 Interfaces

The 3GPP standard for Lawful Interception defines the handover interfaces with different names compared to the ETSI standard. The X n interface corresponds to the INI n interface and is functionally identical to the INI n interface.

18.3.2 Architecture and Configuration of LI Service

Sipwise C5 platform implements the functions defined by LI requirements in a way that it relies on a third party provider for the Lawful Interception Mediation Function (MF).

Regarding other LI functions that are defined by ETSI / 3GPP standards there are 2 possible implementations:

1. Sipwise C5 behaves as the Administration Function (AF) but the actual call data capturing is carried out by other SIP endpoints. In this case Sipwise C5 forwards the calls to be intercepted to its **SIP peers dedicated for LI service**. Within the scope of SIP peer based solution there are still 2 modes of operation:
 - *Call loopback to NGCP*: the LI peer receives the call, extracts IRI and CC data and then routes the call back to NGCP. Sipwise C5 handles the looped back call as if that was initiated from Sipwise C5 and sets up the second call leg to the destination.
 - *Call forwarded by peer directly to destination*: in this case Sipwise C5 will handle the call to LI peer as an ordinary second call leg to the destination.
2. Sipwise **Sipwise C5 itself provides** the required LI functions: AF and call data capturing; IRI and CC of intercepted calls are forwarded to the third party MF from NGCP. Sipwise C5 can be configured in two modes:
 - *Non-Distributed*: The LI roles are hosted on the PROXY nodes. The REST API endpoint to LEA will be the usual MGMT nodes.
 - *Distributed*: The LI roles are hosted on geographically distributed LB+RTP nodes, for example one pair of LB+RTP nodes per country, each of which has different law enforcement authorities. The LB+RTP nodes will provide an *ngcp-panel* instance, which due to privacy laws is specially configured to store intercepts locally (the node will operate on its own set of data), and the external party (law enforcement, LI integration, etc.) interacts with the pertinent LB+RTP nodes via the REST API (or SOAP for older installations).

This handbook will discuss the second setup in detail in the following sections.

The below figure illustrates the logical connection of LI functions on Sipwise C5.

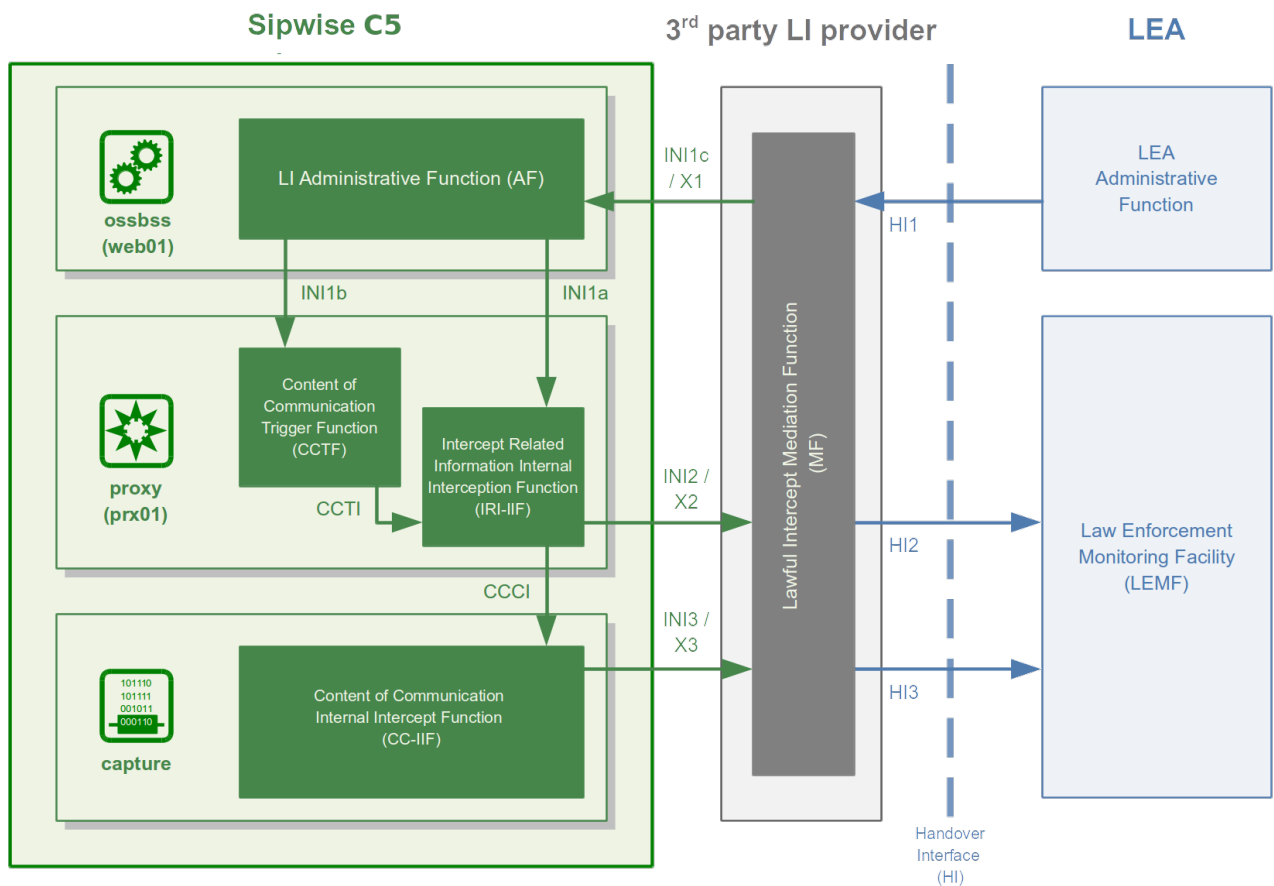

Figure 164: LI with 3rd Party Provider

18.3.2.1 Architecture Based on NGCP Voisniff Module

The implementation of LI services with `captagent` is no longer available and configurable on Sipwise C5, Sipwise requires deploying a revised solution with its `ngcp-voisniff` software module. This newer implementation also relies on a 3rd party LI provider representing the LI Mediation Function (MF), where Sipwise currently (as of Sipwise C5 version mr4.5.2) cooperates with Group2000, Pine and Utimaco.

Sipwise C5 components providing LI functions:

- **ngcp-panel:** this module is responsible for managing REST API for the whole NGCP in general
 - *runs on:* the active node with `web` role (`sp` on PRO; `web01` on CARRIER) on a Sipwise C5 platform
 - *LI functions:* AF; INI1 / X1 interface towards the MF
- **kamailio-proxy:** this module serves as a generic call control function on the NGCP
 - *runs on:* the active node typically with `proxy` role (`sp` on PRO; `prx01` on CARRIER) on a Sipwise C5 platform
 - *LI functions:* CCTF and IRI-IIF; INI2 / X2 interface towards the MF

- **ngcp-voisniff**: this module is a generic element for capturing SIP and RTP traffic on the NGCP
 - *runs on*: the active node typically with lb role (*sp* on PRO; *lb01* on CARRIER) on a Sipwise C5 platform
 - *LI functions*: CC-IIF; INI3 / X3 interface towards the MF

Note

The `ngcp-voisniff` module is installed by default but not activated on the Sipwise C5. It provides the possibility to get call statistics through the Admin web interface, and is not readily configured for LI services. Please contact Sipwise if you need to activate LI services on the platform.

Authentication and Confidentiality

It is required that the communication between the telecommunication operator's network element (that is: Sipwise C5) and the MF be authenticated and confidential, since the intercepted session related data and content of communication must not be disclosed to any 3rd party. For this purpose NGCP's LI service applies authentication and LI session data encryption based on public key cryptography mechanism (TLS).

Both Sipwise C5 and the MF must authenticate themselves by certificates, for this reason Sipwise C5 operator must ensure that valid certificates are deployed on the system. There is a need to contact the 3rd party LI provider, so that he can provide the necessary client certificates that Sipwise C5 will use to setup secured connection to the MF on X2 and X3 interfaces.

Similarly, the MF provider must contact Sipwise C5 operator to offer him valid client certificates that the MF element will use to establish secured connection to the Sipwise C5 on X1 interface.

18.3.2.2 Configuration of LI Service

To enable LI services on Sipwise C5 the platform administrator has to enable lawful interception through the main configuration file (`config.yml`).

For a distributed setup, the `cluster_sets.type` variable has to be set to `distributed` (see Section B.1.8 for more information), and the `lb` nodes need to be assigned the `li` role. For a non-distributed setup, the `proxy` nodes need to be assigned the `li` role.

From the user and program point of view, the `li` role will only be visible in a node if the `intercept.enable` setting is set to `yes`. When the cluster is set up in a distributed mode (that is `cluster_sets.type` is set to `distributed`), the nodes will also have the `li_dist` virtual role visible, so that these can check for a single condition instead of multiple.

Here below is a sample configuration, which shows parameters of `intercept` and `voisniff` sections.

On a CARRIER it would look like:

```
intercept:
  enable: yes
  local: no
  peer:
    acc: no
    inbound_prefix: LI_
```

```
    outbound_prefix: intercept_
    type: voisniff
voisniff:
  admin_panel: no
  daemon:
    custom_bpf: ''
    filter:
      exclude:
        - active: '0'
          case_insensitive: '1'
          pattern: '\ncseq: *\d+ +(register|notify|options)'
      include: []
    sip_ports:
      - 5060
      - 5062
  interfaces:
    extra: []
    types:
      - sip_int
      - sip_ext
      - rtp_ext
  li_x1x2x3:
    call_id:
      del_patterns:
        - _pbx\-1(?:_[0-9]{1,10})?$$
        - _b2b\-1(?:_[0-9]{1,10})?$$
        - _xfer\-1(?:_[0-9]{1,10})?$$
    captagent:
      cin_max: '3000'
      cin_min: '0'
      x2:
        threads: 20
    client_certificate: /etc/ngcp-config/ssl/li/x23_client/x23_client_cert.pem
    enable: yes
    fix_checksums: no
    fragmented: no
    interface:
      excludes: []
    local_name: sipwise
    private_key: /etc/ngcp-config/ssl/li/x23_client/x23_client_cert_priv_key.pem
    split_intercept: no
    x1:
      port: '18090'
    x23:
      protocol: sipwise
  mysql_dump:
    enable: no
```

```

max_query_len: 67108864
num_threads: '4'
rtp_filter: yes
start: yes
threads_per_interface: '10'
partitions:
increment: '700000'
keep: '10'

```

On a PRO it would look like:

```

intercept:
enable: no
local: no
peer:
acc: no
inbound_prefix: LI_
outbound_prefix: intercept_
type: none

voisniff:
admin_panel: yes
daemon:
custom_bpf: ''
filter:
exclude:
- active: '0'
case_insensitive: '1'
pattern: '\ncseq: *\d+ +(register|notify|options)'
include: []
sip_ports:
- 5060
- 5062
interfaces:
extra: []
types:
- sip_int
- sip_ext
- rtp_ext
li_x1x2x3:
call_id:
del_patterns:
- _pbx\ -1(?:_[0-9]{1,10})?$
- _b2b\ -1(?:_[0-9]{1,10})?$
- _xfer\ -1(?:_[0-9]{1,10})?$
captagent:

```

```

    cin_max: '3000'
    cin_min: '0'
    x2:
      threads: 20
    client_certificate: ''
    enable: no
    fix_checksums: no
    fragmented: no
    interface:
      excludes: []
    local_name: sipwise
    split_intercept: no
    x1:
      port: '18090'
    x23:
      protocol: sipwise
mysql_dump:
  enable: yes
  max_query_len: 67108864
  num_threads: '4'
rtp_filter: yes
start: yes
threads_per_interface: '2'
partitions:
  increment: '700000'
  keep: '10'

```

Configuration Parameters

intercept.enable

Set it to `yes` if you want to activate LI service. Default: `no`

intercept.local

On CARRIER systems, if set to `yes`, intercept data will be stored on the local system instead of the central database node.

intercept.peer.acc

Calls to be intercepted may be forwarded to LI peers. The LI peer may forward the call to the original destination, without looping the call back to NGCP. Set this parameter to `yes` if you want to enable billing for such calls. Default: `no`

intercept.peer.inbound_prefix

Calls to be intercepted may be forwarded to LI peers. This parameter specifies the prefix that is prepended to SIP usernames when the call is looped back to NGCP, in order to avoid sending the call again to any LI peer. Used by Sipwise C5 internally. Default: `LI_`

intercept.peer.outbound_prefix

Calls to be intercepted may be forwarded to LI peers. This parameter specifies the prefix that is prepended to SIP usernames when the call is routed to an LI peer. It will be stripped off by rewrite rules of the peer, before sending the call effectively to the peer. Used by Sipwise C5 internally. Default: `intercept_`

intercept.type

The LI service provider module; allowed values are:

- `none`: LI service is not activated
- `peer`: LI service is activated and call data capturing is performed by SIP peers
- `voisniff`: LI service is activated and call data capturing is performed by the `voisniff` module

Default: `none`

voisniff.admin_panel, voisniff.daemon.mysql_dump.*, voisniff.partitions.*

These parameters are not used in LI configuration, but only for call statistics which can be retrieved through the Admin web interface.

voisniff.daemon.custom_bpf

Allows the operator to set a custom packet filter to be used when capturing packets on the network interfaces, overriding the default packet filter generated by the system based on other configuration settings (port ranges, etc). It's not normally necessary to set this. Default: empty

voisniff.daemon.filter.exclude

Additional filter to determine packets that need to be excluded from capturing. This configuration parameter is a list of items, each of them has 3 components:

- `active`: Determines whether the filter is active or not. Allowed values are: 0 (false/inactive; this is the default) or 1 (true/active).
- `case_insensitive`: Determines whether the `pattern` is case-insensitive (1; this is the default) or not (0).
- `pattern`: A regular expression providing the matching pattern for packets that have to be filtered.

voisniff.daemon.filter.include

Additional filter to determine packets that need to be included in capturing. The parameter has the same syntax as `voisniff.daemon.filter.exclude`.

voisniff.daemon.filter.sip_ports

A list of ports that should be considered to carry SIP traffic. Intercepted packets that do not involve one of these ports will not be attempted to be parsed as SIP packets. This filter can be disabled by having this list empty. Default: 5060 and 5062

voisniff.daemon.interfaces.extra

This is a list of additional network interfaces (typically VLAN IDs) where `ngcp-voisniff` should listen for and capture packets. These interfaces are in addition to the list of interfaces generated by the system based on the interface types (see below).

Tip

VLAN interfaces have to be listed when they are used for intercepted calls. On the other hand virtual interfaces for additional IP addresses (e.g. `eth0:1`) do not have to be listed separately, because the base interface (e.g. `eth0`) will be used to capture packets.

voisniff.daemon.interfaces.types

A list of network interface types that should be activated for interception. All interfaces that match the given types will be activated. Default: `sip_int`, `sip_ext`, and `rtp_ext`

voisniff.daemon.li_x1x2x3.call_id.del_patterns

List of NGCP-internal Call-ID suffix patterns that should be ignored when determining the original SIP Call-ID of an intercepted call.

**Caution**

Please do not change these patterns unless instructed to do so by a Sipwise engineer! Changing the patterns may result in falsely recognised Call-IDs and eventually missed SIP messages during an intercepted call.

voisniff.daemon.li_x1x2x3.captagent.cin_min, voisniff.daemon.li_x1x2x3.captagent.cin_max

When using the captagent-compatible protocol, this specifies the range of intercept ID numbers (CIN) to be generated. Default: 0 through 3000

voisniff.daemon.li_x1x2x3.captagent.x2.threads

When using the captagent-compatible protocol, this specifies the number of threads to be used for sending outgoing X2 (SIP) captures. Interception may stall if this number is set too low. Default: 20

voisniff.daemon.li_x1x2x3.client_certificate

The client certificate that Sipwise C5 uses to connect over TLS to a 3rd party LI provider. Relevant only when using the `sipwise` outbound protocol.

voisniff.daemon.li_x1x2x3.enable

Set it to `yes` to enable LI services via X1, X2 and X3 interfaces. Default: `no`

voisniff.daemon.li_x1x2x3.fix_checksums

When enabled (= `yes`), Sipwise C5 will calculate UDP header checksum for packets sent out on X2 and X3 interfaces. This is necessary when the checksum calculation is normally left to the network interface hardware and therefore the UDP header checksum is inherently incorrect on application level. Also the UDP checksum must be calculated by `ngcp-voisniff` on re-assembled packets, so enable this option if there are fragmented packets in intercepted call traffic. Default: disabled (= `no`)

voisniff.daemon.li_x1x2x3.fragmented

When disabled (= `no`), `ngcp-voisniff` defragments all packets and sends out only reassembled packets via X2 and X3 interfaces. If the option is enabled (= `yes`), `ngcp-voisniff` will instead send out the original fragments via X2 and X3. Default: `no`

voisniff.daemon.li_x1x2x3.instant_intercept

When disabled (= `no`), creating a new interception object does not affect already running calls. In other words, if a call that is already running matches the parameters by a newly created interception object, that call will not start to be intercepted, only new calls established afterwards will. Enabling this option changes this behaviour so that already running calls will also start to be intercepted at the moment when a new interception object is created. Doing so creates additional processing overhead within `ngcp-voisniff`. Default: `no`

voisniff.daemon.li_x1x2x3.interface.excludes

This is a list of interfaces that must be excluded from the interception procedures. The list contains regular expressions that describe the to-be-excluded interfaces, for example: – `^lo$` to exclude the loopback interface. Default: empty list

voisniff.daemon.li_x1x2x3.local_name

This parameter maps to the `header.source` field of the X2 protocol. It's an arbitrary string and can be used to identify the sending Sipwise C5 system. Default: `sipwise`

Note

As of Sipwise C5 version mr4.5.2, this is currently not used.

voisniff.daemon.li_x1x2x3.private_key

The private key that Sipwise C5 uses to connect over TLS to a 3rd party LI provider. Only necessary if the client certificate file does not include the private key.

voisniff.daemon.li_x1x2x3.split_intercept

When enabled (= `yes`), `ngcp-voisniff` uses the Split-LI algorithm to detect which calls have to be intercepted. This algorithm should be enabled only on CARRIER systems with a central core and local satellites architecture and `ngcp-voisniff` running on LB nodes. Default: `no`

voisniff.daemon.li_x1x2x3.x1.port

The port number on which `ngcp-voisniff` listens for incoming X1 messages. Default: 18090

**Caution**

You should leave the parameter set to the default value, unless there is a good reason to change it.

voisniff.daemon.li_x1x2x3.x23.protocol

Specified the outbound protocol to speak when delivering X2 (SIP) or X3 (RTP) data. This can be either the `sipwise` protocol using TLS connections, or the `captagent` compatible protocol using HTTP and UDP. Default: `sipwise`

voisniff.daemon.mysql_dump.enable

Master switch for call statistics collection. Default: `yes`

voisniff.daemon.mysql_dump.max_query_len

Determines how much data should be gathered into a single statement for insertion into the database. This should not normally be changed. Default: 67108864

voisniff.daemon.mysql_dump.num_threads

The number of threads dedicated to inserting data into the database. Default: 4

voisniff.daemon.rtp_filter

Determined whether to intercept RTP packets or not. Enabling the filter (set to `yes`) suppresses interception of RTP packets. Disabling it (`no`) enabled interception of RTP packets. Default: `yes`

voisniff.daemon.start

Determines whether `voisniff` service must be started on the platform. Set it to `yes` if you'd like to activate `voisniff` that is needed for LI service too. Default: `no` (on CARRIER), `yes` (on PRO)

voisniff.daemon.threads_per_interface

This is a performance tuning option and controls how many threads per enabled sniffing interface should be launched. Example: if it's set to 10 and 3 interfaces are enabled for sniffing, a total of 30 threads will be launched. Default: 2

**Caution**

Do not set it to a high number, or simply leave it at its default value, unless there is a performance problem with `voisniff` service. Please keep in mind that a high number of threads might also decrease the overall system performance of NGCP!

18.3.3 X1, X2 and X3 Interface Specification

Short description of X_n interfaces:

- The **X1** interface is used by an LI provider to create, modify, delete and list interceptions on Sipwise C5 . It is designed as RESTful HTTP interface using JSON (with JSON-HAL in responses from the NGCP) as content type to provision interceptions.
- The **X2** interface is a TLV based interface with JSON payload with a simple request/response mechanism over a secure TLS connection, used to pass intercepted signaling data towards an LI provider.
- The **X3** interface is also a TLV based interface with a binary payload encapsulating the intercepted RTP data.

18.3.3.1 X1 Interface

The resource used to work with interceptions is always `https://ngcp-ip:1443/api/interceptions/`

Authentication

Authentication and authorization on Sipwise C5 API is performed via HTTP Basic Auth or SSL Client certificates.

- **HTTP Basic Auth:** With `cURL` use `--user username:password` option to specify your access credentials.

```
curl -i -X GET --user myuser:mypassword https://example.org:1443/api/interceptions/
```

Additionally use the `--insecure` option if you are testing against a self-signed server certificate.

- **SSL Client Authentication:** You can generate and download client certificates for administrators and resellers via Sipwise C5 Panel in the Administrators view.

For the actual client authentication, you will need two files which you can download from the panel after creating the client certificates:

1. The client certificate generated via Sipwise C5 Panel. This is usually labelled `NGCP-API-client-certificate-xxxxx.pem`.
2. The CA certificate used to sign the server certificate, in case it as been self-signed or the CA is not recognized by the client host environment.

With *cURL* use `--cert /path/to/NGCPAPIclientcertificatexxxxxx.pem` to specify the client certificate, and `--cacert /path/to/cacert.pem` to specify the CA certificate in case of a self-signed server certificate.

```
curl -i -X GET --cert /path/to/NGCPAPIclientcertificatexxxxxx.pem \  
--cacert /path/to/cacert.pem https://example.org:1443/api/interceptions/
```

Additionally use the `--insecure` option if you are testing against a self-signed server certificate.

API Description

Collection Actions

Allowed methods for the collection as in `METHOD /api/interceptions/`

- OPTIONS
- POST
- GET
- HEAD

Item Actions

Allowed methods for a collection item as in `METHOD /api/interceptions/id`

- PATCH
- OPTIONS
- DELETE
- PUT
- GET
- HEAD

Properties

- `liid` (Number): The LI ID for this interception.
- `number` (String): The number to intercept.
- `x2_host` (String): The IP address of the X2 interface.
- `x2_password` (null, String): The password for authenticating on the X2 interface.
- `x2_port` (Number): The port of the X2 interface.
- `x2_user` (null, String): The username for authenticating on the X2 interface.
- `x3_host` (null, String): The IP address of the X3 interface.
- `x3_port` (null, Number): The port of the X3 interface.
- `x3_required` (null, Boolean): Whether to also intercept call content via X3 interface (`false` by default).

Query Parameters

- `liid`: Filter for interceptions of a specific interception ID

- **number:** Filter for interceptions of a specific number (in E.164 format)
- **order_by:** Order collection by a specific attribute. Possible values are: `id`, `reseller_id`, `liid`, `number`, `cc_required`, `delivery_host`, `delivery_port`, `delivery_user`, `delivery_pass`, `modify_times`, `create_timestamp`, `deleted`, `uuid`, `sip_username`, `sip_domain`, `cc_delivery_host`, `cc_delivery`
- **order_by_direction:** Direction which the collection should be ordered by. Possible values are: `asc` (default), `desc`

API Examples

Get a specific interception

- Request:

```
curl -i --insecure --user administrator:administrator -X GET
https://localhost:1443/api/interceptions/528
```

- Response:

```
HTTP/1.1 200 OK
Server: nginx
Date: Tue, 01 Dec 2015 09:43:41 GMT
ContentType: application/hal+json; profile="http://purl.org/sipwise/ngcpapi/";
  charset=utf8
ContentLength: 634
Connection: keepalive
Link: </api/interceptions/>; rel=collection
Link: <http://purl.org/sipwise/ngcpapi/>; rel=profile
Link: </api/interceptions/528>; rel="item self"
SetCookie: ngcp_panel_session=35b56d921c36c1fc6edb8fcd0a86dd9af61ec62a; path=/;
  expires=Tue, 01 Dec 2015 10:43:41 GMT; HttpOnly
StrictTransportSecurity: maxage=15768000
{
  "_links" : {
    "collection" : {
      "href" : "/api/interceptions/"
    },
    "curies" : {
      "href" : "http://purl.org/sipwise/ngcpapi/#rel{rel}",
      "name" : "ngcp",
      "templated" : true
    },
    "profile" : {
      "href" : "http://purl.org/sipwise/ngcpapi/"
    },
    "self" : {
```

```

    "href" : "/api/interceptions/528"
  }
},
"id" : 528,
"liid" : 918273,
"number" : "0014155550132",
"x2_host" : "192.168.42.42",
"x2_password" : null,
"x2_port" : 3002,
"x2_user" : null,
"x3_host" : "192.168.42.42",
"x3_port" : 3003,
"x3_required" : true
}

```

Get all interceptions for a number

- Request:

```

curl -i --insecure --user administrator:administrator -X GET \
https://localhost:1443/api/interceptions/?number=0014155550132

```

- Response:

```

HTTP/1.1 200 OK
Server: nginx
Date: Tue, 01 Dec 2015 09:47:36 GMT
ContentType: application/hal+json; profile="http://purl.org/sipwise/ngcpapi/";
  charset=utf8
ContentLength: 1283
Connection: keepalive
SetCookie: ngcp_panel_session=238550c5737058db619b183d925b5f9a61261cfe; path=/;
  expires=Tue, 01 Dec 2015 10:47:36 GMT; HttpOnly
StrictTransportSecurity: maxage=15768000
{
  "_embedded" : {
    "ngcp:interceptions" : {
      "_links" : {
        "collection" : {
          "href" : "/api/interceptions/"
        },
      },
      "curies" : {
        "href" : "http://purl.org/sipwise/ngcpapi/#rel{rel}",
        "name" : "ngcp",
        "templated" : true
      }
    }
  }
}

```

```
    },
    "profile" : {
      "href" : "http://purl.org/sipwise/ngcpapi/"
    },
    "self" : {
      "href" : "/api/interceptions/520"
    }
  },
  "id" : 520,
  "liid" : 1,
  "number" : "0014155550132",
  "x2_host" : "192.168.42.42",
  "x2_password" : null,
  "x2_port" : 3002,
  "x2_user" : null,
  "x3_host" : "192.168.42.42",
  "x3_port" : 3003,
  "x3_required" : true
}
},
"_links" : {
  "curies" : {
    "href" : "http://purl.org/sipwise/ngcpapi/#rel{rel}",
    "name" : "ngcp",
    "templated" : true
  },
  "ngcp:interceptions" : {
    "href" : "/api/interceptions/520"
  },
  "profile" : {
    "href" : "http://purl.org/sipwise/ngcpapi/"
  },
  "self" : {
    "href" : "/api/interceptions/?page=1&rows=10"
  }
},
"total_count" : 1
}
```

Get all interceptions for all numbers

- Request:

```
curl -i --insecure --user administrator:administrator -X GET \
https://localhost:1443/api/interceptions/
```

• Response:

```
HTTP/1.1 200 OK
Server: nginx
Date: Tue, 01 Dec 2015 09:43:18 GMT
ContentType: application/hal+json; profile="http://purl.org/sipwise/ngcpapi/";
  charset=utf8
ContentLength: 2364
Connection: keepalive
SetCookie: ngcp_panel_session=68398eea5bdd3885ad0517e1f6d367ccc80111fa; path=/;
  expires=Tue, 01 Dec 2015 10:43:18 GMT; HttpOnly
StrictTransportSecurity: maxage=15768000
{
  "_embedded" : {
    "ngcp:interceptions" : [
      {
        "_links" : {
          "collection" : {
            "href" : "/api/interceptions/"
          },
          "curies" : {
            "href" : "http://purl.org/sipwise/ngcpapi/#rel{rel}",
            "name" : "ngcp",
            "templated" : true
          },
          "profile" : {
            "href" : "http://purl.org/sipwise/ngcpapi/"
          },
          "self" : {
            "href" : "/api/interceptions/520"
          }
        },
        "id" : 520,
        "liid" : 1,
        "number" : "0014155550132",
        "x2_host" : "192.168.42.42",
        "x2_password" : null,
        "x2_port" : 3002,
        "x2_user" : null,
        "x3_host" : "192.168.42.42",
        "x3_port" : 3003,
        "x3_required" : true
      },
      {
        "_links" : {
          "collection" : {
            "href" : "/api/interceptions/"
          }
        }
      }
    ]
  }
}
```



```
    },
    "curies" : {
      "href" : "http://purl.org/sipwise/ngcpapi/#rel{rel}",
      "name" : "ngcp",
      "templated" : true
    },
    "profile" : {
      "href" : "http://purl.org/sipwise/ngcpapi/"
    },
    "self" : {
      "href" : "/api/interceptions/528"
    }
  },
  "id" : 528,
  "liid" : 918273,
  "number" : "0014155550132",
  "x2_host" : "192.168.42.42",
  "x2_password" : null,
  "x2_port" : 3002,          "x2_user" : null,
  "x3_host" : "192.168.42.42",
  "x3_port" : 3003,
  "x3_required" : true
}
]
},
"_links" : {
  "curies" : {
    "href" : "http://purl.org/sipwise/ngcpapi/#rel{rel}",
    "name" : "ngcp",
    "templated" : true
  },
  "ngcp:interceptions" : [
    {
      "href" : "/api/interceptions/520"
    },
    {
      "href" : "/api/interceptions/528"
    }
  ],
  "profile" : {
    "href" : "http://purl.org/sipwise/ngcpapi/"
  },
  "self" : {
    "href" : "/api/interceptions/?page=1&rows=10"
  }
},
"total_count" : 2
```

```
}
```

Get interception for specific LIID

- Request:

```
curl -i --insecure --user administrator:administrator -X GET \  
https://localhost:1443/api/interceptions/?liid=9876
```

- Response:

```
HTTP/1.1 200 OK  
Server: nginx  
Date: Tue, 01 Dec 2015 09:50:41 GMT  
ContentType: application/hal+json; profile="http://purl.org/sipwise/ngcpapi/";  
  charset=utf8  
ContentLength: 1283  
Connection: keepalive  
SetCookie: ngcp_panel_session=23960dde6bb90f0c5c84575890194c53cce120ce; path=/  
  expires=Tue, 01 Dec 2015 10:50:40 GMT; HttpOnly  
StrictTransportSecurity: maxage=15768000  
{  
  "_embedded" : {  
    "ngcp:interceptions" : {  
      "_links" : {  
        "collection" : {  
          "href" : "/api/interceptions/"  
        },  
        "curies" : {  
          "href" : "http://purl.org/sipwise/ngcpapi/#rel{rel}",  
          "name" : "ngcp",  
          "templated" : true  
        },  
        "profile" : {  
          "href" : "http://purl.org/sipwise/ngcpapi/"  
        },  
        "self" : {  
          "href" : "/api/interceptions/520"  
        }  
      },  
      "id" : 520,  
      "liid" : 1,  
      "number" : "0014155550132",  
      "x2_host" : "192.168.42.42",  
      "x2_password" : null,  
    }  
  }  
}
```

```

    "x2_port" : 3002,
    "x2_user" : null,
    "x3_host" : "192.168.42.42",
    "x3_port" : 3003,
    "x3_required" : true
  }
},
"_links" : {
  "curies" : {
    "href" : "http://purl.org/sipwise/ngcpapi/#rel{rel}",
    "name" : "ngcp",
    "templated" : true
  },
  "ngcp:interceptions" : {
    "href" : "/api/interceptions/520"
  },
  "profile" : {
    "href" : "http://purl.org/sipwise/ngcpapi/"
  },
  "self" : {
    "href" : "/api/interceptions/?page=1&rows=10"
  }
},
"total_count" : 1
}

```

Create interception for a specific number

- Request:

```

curl -i --insecure --user administrator:administrator -X POST \
-H "ContentType: application/json" --data \
'{"liid":123, "number":"31032222203", "x2_host":"127.0.0.1", "x2_port":12345,
  "x3_required":true, "x3_host":"127.0.0.2", "x3_port":23456}' \
https://localhost:1443/api/interceptions/

```

- Response:

```

HTTP/1.1 201 Created
TransferEncoding: chunked
Connection: close
Location: /api/interceptions/528
SetCookie: ngcp_panel_session=e7817079d121fae4d86448b10e1fa21d0201c526; path=/;
  expires=Tue, 01 Dec 2015 10:43:18 GMT; HttpOnly
StrictTransportSecurity: maxage=15768000

```

The path to the newly created interception is found in the *Location* header of the response.

Update specific interception

- Request:

```
curl -i --insecure --user administrator:administrator -X PUT \  
-H "ContentType: application/json" -H 'Prefer: return=representation' --data \  
'{"liid":918273, "number":"0014155550132", "x2_host":"192.168.42.42", "x2_port":5000, \  
  "x3_required":false}' \  
https://localhost:1443/api/interceptions/123
```

- Response:

```
HTTP/1.1 200 OK  
ContentType: application/hal+json; profile="http://purl.org/sipwise/ngcpapi/";  
  charset=utf8  
ContentLength: 621  
Link: </api/interceptions/>; rel=collection  
Link: <http://purl.org/sipwise/ngcpapi/>; rel=profile  
Link: </api/interceptions/530>; rel=self  
PreferenceApplied: return=representation  
SetCookie: ngcp_panel_session=0b56e4a197b0e9f6e22a998e85473a0184770740; path=/  
  expires=Tue, 01 Dec 2015 10:56:17 GMT; HttpOnly  
{  
  "_links" : {  
    "collection" : {  
      "href" : "/api/interceptions/"  
    },  
    "curies" : {  
      "href" : "http://purl.org/sipwise/ngcpapi/#rel{rel}",  
      "name" : "ngcp",  
      "templated" : true  
    },  
    "profile" : {  
      "href" : "http://purl.org/sipwise/ngcpapi/"  
    },  
    "self" : {  
      "href" : "/api/interceptions/530"  
    }  
  },  
  "id" : 530,  
  "liid" : 918273,  
  "number" : "0014155550132",  
  "x2_host" : "192.168.42.42",  
  "x2_password" : null,
```

```

    "x2_port" : 5000,
    "x2_user" : null,
    "x3_host" : null,
    "x3_port" : null,
    "x3_required" : false
}

```

The *Prefer: return=representation* header forces the API to return the content, otherwise status 201 with no content is returned.

Update only certain items for a specific interception

- Request:

```

curl -i --insecure --user administrator:administrator -X PATCH \
-H "Content-Type: application/jsonpatch+json" -H 'Prefer: return=representation' \
--data '[{"op":"replace", "path":"/x2_host", "value":"192.168.42.42"}, {"op":"replace",
"path":"/x2_port", "value":4000}]' \
https://localhost:1443/api/interceptions/530

```

- Response:

```

HTTP/1.1 200 OK
Server: nginx
Date: Tue, 01 Dec 2015 10:06:06 GMT
Content-Type: application/hal+json; profile="http://purl.org/sipwise/ngcpapi/";
charset=utf8
Content-Length: 620
Connection: close
Link: </api/interceptions/>; rel=collection
Link: <http://purl.org/sipwise/ngcpapi/>; rel=profile
Link: </api/interceptions/530>; rel=self
Preference-Applied: return=representation
Set-Cookie: ngcp_panel_session=0693129d63d543a85f96d464ff9a8f807cfc4d18; path=/;
expires=Tue, 01 Dec 2015 11:06:06 GMT; HttpOnly
Strict-Transport-Security: max-age=15768000
{
  "_links" : {
    "collection" : {
      "href" : "/api/interceptions/"
    },
    "curies" : {
      "href" : "http://purl.org/sipwise/ngcpapi/#rel{rel}",
      "name" : "ngcp",
      "templated" : true
    },
    "profile" : {

```

```

    "href" : "http://purl.org/sipwise/ngcpapi/"
  },
  "self" : {
    "href" : "/api/interceptions/530"
  }
},
"id" : 530,
"liid" : 918273,
"number" : "0014155550132",
"x2_host" : "192.168.42.42",
"x2_password" : null,
"x2_port" : 4000,
"x2_user" : null,
"x3_host" : null,
"x3_port" : null,
"x3_required" : false
}

```

Delete specific interception

- Request:

```

curl -i --insecure --user administrator:administrator -X DELETE \
https://localhost:1443/api/interceptions/123

```

- Response:

```

HTTP/1.1 204 No Content
Server: nginx
Date: Tue, 01 Dec 2015 10:08:49 GMT
Connection: keepalive
Set-Cookie: ngcp_panel_session=570c66b66732629766f86b8ed9bd0d64902ae73e; path=/;
    expires=Tue, 01 Dec 2015 11:08:49 GMT; HttpOnly
XCatalyst: 5.90042
StrictTransportSecurity: maxage=15768000

```

18.3.3.2 X2 Interface

The communication via the X2 interface consists of request-response pairs.

Request

The request is formatted as: X2/<bodylength>/<body>

Body part has the following items:

Table 26: X2 Message Body Items

Element	Type	Length	Description
/x2/header/source	String	arbitrary length	identifier of Sipwise node which captured the data
/x2/header/destination	String	arbitrary length	identifier of LI mediation system
/x2/header/type	String	arbitrary length	always "sip" (but later potentially "xmpp" and others too)
/x2/header/version	PosInteger	arbitrary length	always "1"
/x2/header/timestamp	String	27 chars	format: YYYY-MM-DDThh:mm:ss.ffffffZ; timestamp in UTC when the X2 package is sent to mediation
/x2/body/dialogid	PosInteger	arbitrary length	globally increasing counter for each new communication dialog (e.g. call)
/x2/body/messageid	PosInteger	arbitrary length	increasing counter for each new x2 message within a dialog, starting from 0
/x2/body/timestamp	String	27 chars	format: YYYY-MM-DDThh:mm:ss.ffffffZ; timestamp in UTC when the package has been captured on the wire
/x2/body/interceptions			one or more elements containing the following information, one element per intercepted target:
/x2/body/interceptions/liid	PosInteger	arbitrary length	interception id ("liid") as set via X1 interface
/x2/body/interceptions/direction	String	arbitrary length	either "totarget" or "fromtarget" from the soft-switch perspective (if target is the called party, it is "totarget", if target is the calling party, it is "fromtarget").
/x2/body/data	Base64 encoded	arbitrary	content of full IP frame and up on the OSI layer; packets fragmented on the wire are provided in fully assembled format

Example of full message:

```
x2/418/
{
  "header": {
    "source": "prx01a.example.com",
    "destination": "x2destination.example.com",
    "type": "sip",
    "version": 1,
    "timestamp": "2015 03 11T09:18:04.729803Z"
  },

```

```

"body": {
  "dialogid": 4,
  "messageid": 0,
  "timestamp": "2015 03 11T09:18:04.729123Z",
  "interceptions": [
    { "liid": 174, "direction": "fromtarget" },
    { "liid": 175, "direction": "totarget" }
  ],
  "data": "<base64 encoded ip,udp/tcp,sip frame>"
}
}

```

Response

- Success: X2-ACK/0/
- Error: X2-ERR/<length>/<error string>

Keep-Alive Mechanism

A regular keep-alive mechanism with a default value of 10s is used on the connection if it is re-used across multiple messages.

- Request: X2/0/
- Response: X2-ACK/0/

18.3.3.3 X3 Interface

On the X3 interface TLV based packets are sent via secured (TLS) connection on a pre-established stream. X3 messages do not need to be acknowledged, except for keep-alive messages.

X3 Message Structure

Table 27: X3 Message Structure

Field	Length
Header	arbitrary
CCCID	4 bytes
MessageId	4 bytes
Timestamp	8 bytes
Payload	arbitrary

Header Details

Table 28: X3: Header Details

Field	Length	Content
type	2 bytes	always "X3"
delimiter	1 byte	always "/"
length	arbitrary	ASCII string
delimiter	1 byte	always "/"

CCCID Details

`dialogid` (32 bit in network byte order, reset to 0 after $2^{32}-1$)

The `dialogid` is referencing the `/x2/body/dialogid` field in order to correlate an X3 packet to an X2 call.

MessageId Details

`messageid` (32 bit in network byte order, reset to 0 after $2^{32}-1$)

The `messageid` is a counter within a dialog sequencing the X3 packets sent from the NGCP. This counter is not correlated in any way with X2, rather than starting at 0 with the first RTP packet captured within a dialog.

Timestamp Details

- `seconds` (32 bit in network byte order)
- `fraction` (32 bit in network byte order)

The timestamp represents the Unix epoch starting from 1970-01-01.

Payload Details

Table 29: X3: Payload Details

Field	Length
original ip header	20 bytes for v4, 40 bytes for v6
original udp header	8 bytes
original rtp header	variable, 12-72 bytes
original rtp payload	arbitrary

Keep-Alive Mechanism

A regular keep-alive mechanism with a default value of 10s is used on the connection if it is re-used across multiple messages.

- Request: X3/0/
- Response: X3-ACK/0/

18.4 3rd Party Call Control

18.4.1 Introduction

The Sipwise C5 offers the possibility to perform call control through 3rd party applications. This functionality, called **Party Call Control** and referred to as "**PCC**" throughout this handbook, is available since mr5.1.1 release.

Incoming calls to local subscribers may be signalled to a 3rd party CAC (Call Admission Control) server. Before accepting (that is: sending the SIP *INVITE* request to the called subscriber) or rejecting the call, Sipwise C5 will wait for an explicit reply from the CAC / PCC server, or a timeout.

Short Messages received by Sipwise C5 for a local subscriber may also be signalled to the PCC server. After an explicit reply with "accepted" status from the PCC server, Sipwise C5 will forward the SM to the final recipient.



Important

Sipwise C5 does not support delivering SMs to the local subscribers directly. Local subscribers can define a *Call Forward for SMS* instead, thus allowing themselves to receive SMs on their mobile phones.

3rd party call control may be implemented in many ways, such as by server-side or client-side applications (e.g. smartphone app).

Note

Please note that Sipwise C5 implements a proprietary protocol for PCC deployments and adapting the protocol to customer needs requires software development from Sipwise.

18.4.2 Details of Call Processing with PCC

18.4.2.1 Overview

The following figure presents the schema of incoming call processing when PCC is involved:

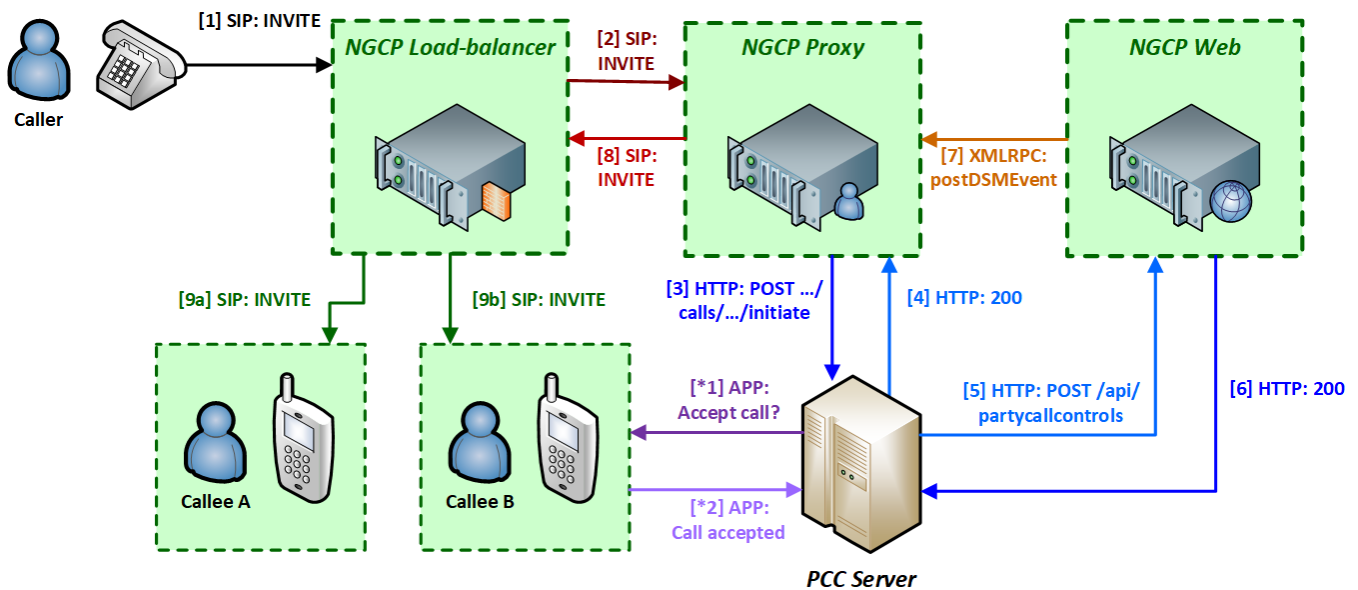

Figure 165: Overview of Party Call Control

The messages / interactions of PCC call processing are:

1. Sipwise C5 Load-Balancer receives a SIP *INVITE* message from the caller.
2. The LB forwards the *INVITE* to the PROXY component as usual with every incoming call.
3. The PROXY (*kamailio-proxy* module) checks whether the called subscriber has the PCC feature activated. If this is the case, it will send an HTTP *POST* or *GET* request (configurable) to the PCC server with the most important details of the call (such as calling and called party numbers, call-ID, a token for internal identification of the session).
4. The PCC server replies with *200 OK* HTTP status in order to indicate that it understood the request and will provide the final status (such as *ACCEPTED* or *REJECTED*) of the call later.
- *Optional:*
 - *1) The PCC server requests the subscriber's confirmation to accept the call for instance via a smartphone app.
 - *2) The subscriber indicates accepting the call to the PCC server.
5. The PCC server send an HTTP *POST* request to the WEB component of NGCP, using Sipwise C5 REST API, to signal accepting the call.
6. The WEB will reply with *200 OK* HTTP status.
7. The WEB sends an internal XMLRPC request to PROXY indicating that the incoming call can be accepted.
8. The PROXY sends the SIP *INVITE* message to the LB, i.e. it continues the call setup as usual.
9. The LB sends the *INVITE* to the subscriber.

There are more software modules within NGCP's components and those are shown separately on the diagrams in following sections of the handbook. For instance the PROXY component has the *kamailio-proxy* and *ngcp-sems* modules.

18.4.2.2 Successful Call Initiation at PCC Server

A subscriber with PCC activated will not receive the SIP *INVITE* request directly, but only after a series of intermediate CAC (Call Admission Control) steps, involving Sipwise C5 Proxy and the PCC server. First of those steps is the call initiation at the PCC server:

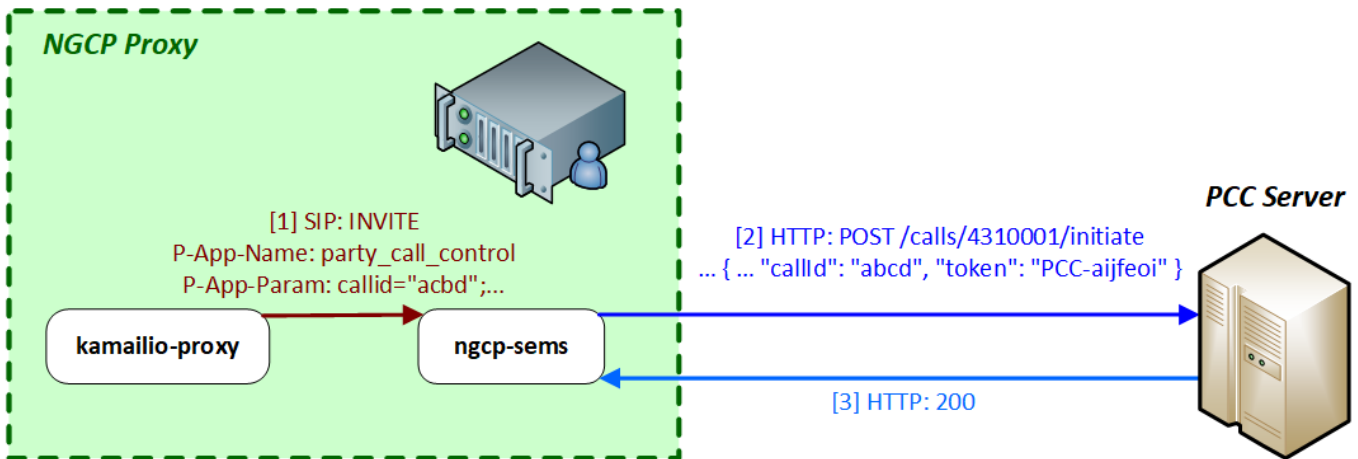

Figure 166: Successful Call Initiation with PCC

1. When *kamailio-proxy* receives the *INVITE* request from Sipwise C5 LB, it will forward the message to *ngcp-sems* module with 2 private SIP headers:

```
P-App-Name: party_call_control
P-App-Param: callid="acbd";caller="4369912345";callee="4310001";caller_clir="0";
```

2. These headers will activate the PCC function in *ngcp-sems* and it will send an HTTP *POST* request to the PCC server, instead of creating the second call leg directly towards Sipwise C5 LB. An example of such a request (not all details included):

```
POST /calls/4310001/initiate HTTP/1.1
Content-Type: application/json

{
  "actualMsisdn": 4369912345,
  "callingMsisdn": 4310001,
  "actualClir": 0,
  "callId": "abcd",
  "token": "PCC-aijfeoi"
}
```

where:

- `actualMsisdn`: calling party number

- `callingMsisdn`: called party number
- `actualClir`: non-0 if CLIR is active
- `callid`: the SIP Call-ID
- `token`: a generated token that identifies the session between Sipwise C5 and the PCC server

The target URL has the format: `/calls/<called_party_num>/initiate`

3. The PCC server replies with HTTP `200 OK` if it understood the request and can proceed with working on that.

18.4.2.3 Call Initiation at PCC Server with Error

The `ngcp-sems` module on Sipwise C5 Proxy will wait for a response from PCC server, once it has sent the "initiate" request to it. If the PCC server responds with an HTTP error status, such as any `4xx`, then `ngcp-sems` reports the error condition of PCC server with a SIP `487 Request Terminated` reply to `kamailio-proxy`.

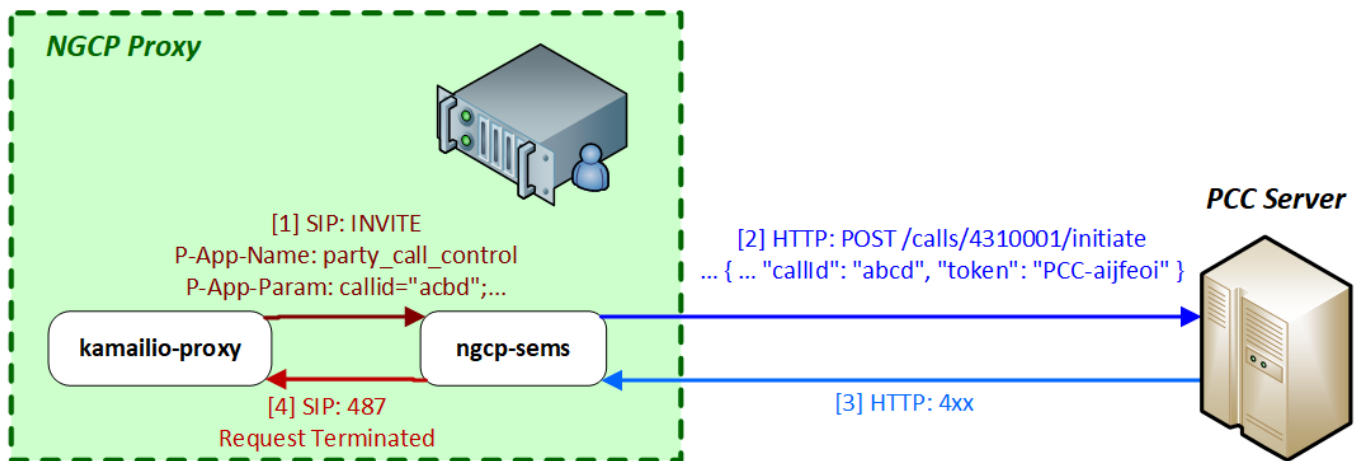

Figure 167: Call Initiation Error with PCC

18.4.2.4 Call Initiation at PCC Server with Timeout

The `ngcp-sems` module on Sipwise C5 Proxy will wait for a response from PCC server, once it has sent the "initiate" request to it. If the PCC server does not respond with HTTP `200 OK` within 30 seconds (configurable) then `ngcp-sems` considers the PCC is not available. In such a case `ngcp-sems` sends a SIP `408 Timeout` reply to `kamailio-proxy`.

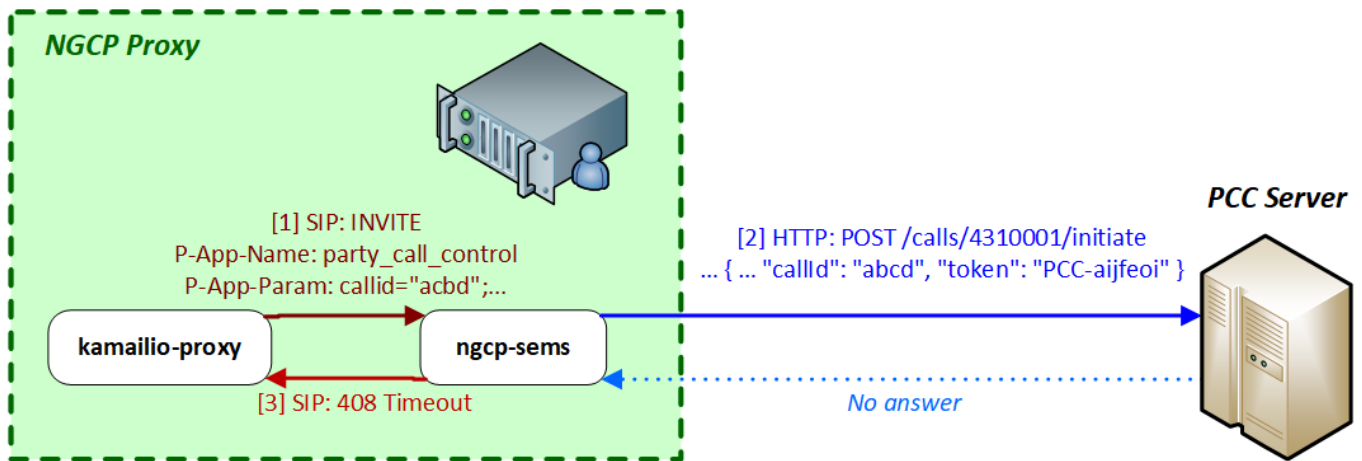

Figure 168: Call Initiation Timeout with PCC

18.4.2.5 Call Accepted by PCC Server

If the PCC server (eventually this may also be the called subscriber) accepts the call, the PCC server will send an HTTP *POST* request to the REST API interface of Sipwise C5 (Web/Management component). This request must contain a `status` field with the content `ACCEPT` (configurable) so that Sipwise C5 continues the call setup towards called party. Example:

```
POST /api/partycallcontrols HTTP/1.1
Content-Type: application/json

{
  "type": "pcc",
  "caller": 4369912345,
  "callee": 4310001,
  "status": "ACCEPT",
  "callId": "abcd",
  "token": "PCC-aijfeoi"
}
```

The target URL of the request: `/api/partycallcontrols`. The `type` parameter must have a value of `pcc`.

You can see the flow of messages in the diagram below:

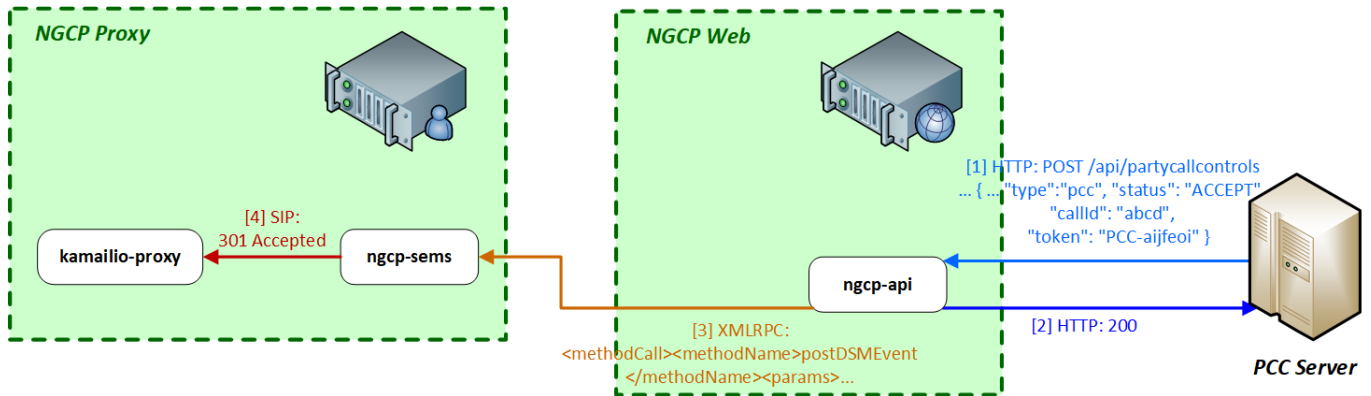

Figure 169: Call Accepted by PCC

1. The PCC server sends an HTTP *POST* request to NGCP's REST API.
2. Sipwise C5 Web will reply with *200 OK* HTTP status once the request is validated.
3. The *ngcp-panel* module generates an XMLRPC call to the *ngcp-sems* module on the PROXY. An example is shown here:

```
<?xml version="1.0"?>
<methodCall>
  <methodName>postDSMEvent</methodName>
  <params>
    <param>
      <value><string>PCC-aijfeoi</string></value>
    </param>
    <param>
      <value><array><data>
        <value><array><data>
          <value><string>cmd</string></value>
          <value><string>handleCall</string></value>
        </data></array></value>
        <value><array><data>
          <value><string>callid</string></value>
          <value><string>abcd</string></value>
        </data></array></value>
        <value><array><data>
          <value><string>caller</string></value>
          <value><string>4369912345</string></value>
        </data></array></value>
        <value><array><data>
          <value><string>callee</string></value>
          <value><string>4310001</string></value>
        </data></array></value>
        <value><array><data>
          <value><string>status</string></value>
        </data></array></value>
      </value>
    </param>
  </params>
</methodCall>
```

```

    <value><string>ACCEPT</string></value>
  </data></array></value>
</data></array></value>
</param>
</params>
</methodCall>

```

At this point *ngcp-sems* examines the following:

- whether the token (listed as first `param` parameter of `postDSMEvent`) matches any of the saved session tokens
- whether the `callid` parameter's value matches the session's SIP Call-ID
- whether the `status` parameter's value is `ACCEPT` (configurable)

and if all those conditions are valid it will indicate to *kamailio-proxy* module that the call can be accepted (i.e. call setup towards the callee may continue).

4. *ngcp-sems* module sends `301 Accepted` SIP response to *kamailio-proxy* and the latter can forward the SIP `INVITE` message to Sipwise C5 LB. If the `status` parameter's value is not `ACCEPT` (configurable), *ngcp-sems* will reply `487 Request Terminated` to *kamailio-proxy*.

18.4.2.6 Indicating Call Termination at PCC Server

In the same manner as call initiation happens, call termination is also reported by Sipwise C5 towards the PCC server.

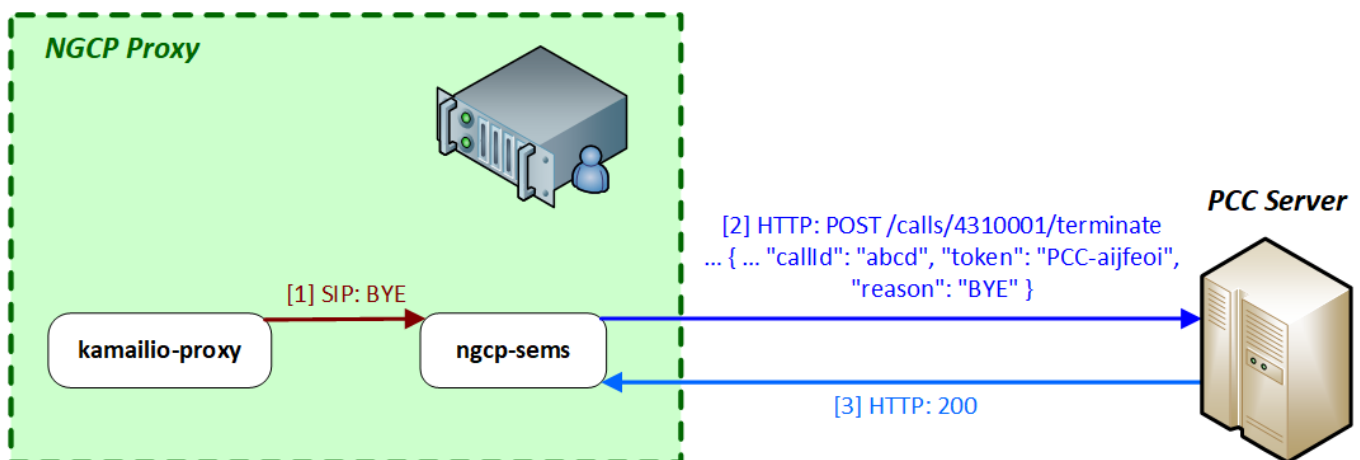

Figure 170: Call Termination with PCC

The target URL of the HTTP `POST` request for the call termination case looks like: `/calls/<called_party_num>/terminate`

The body of the request must contain the following element: `"reason": "BYE"`, where the reason can be one of `BYE`, `CANCEL`, `NOANSWER` and `REJECT`. An example of a call termination request:

```

POST /calls/4310001/terminate HTTP/1.1
Content-Type: application/json

```



```
{
  "actualMsisdn": 4369912345,
  "callingMsisdn": 4310001,
  "actualClir": 0,
  "callId": "abcd",
  "token": "PCC-aijfeoi",
  "reason": "BYE"
}
```

Sipwise C5 will not take the response of PCC server into consideration, because the call has already been terminated at SIP protocol level.

18.4.3 Voicemail Notification

18.4.3.1 Using the PCC Framework

The PCC call control framework may also be used for voicemail notifications. The Sipwise C5 involves its elements: *asterisk* (Voicemail server) and *ngcp-vmnotify* in the process of the notification.

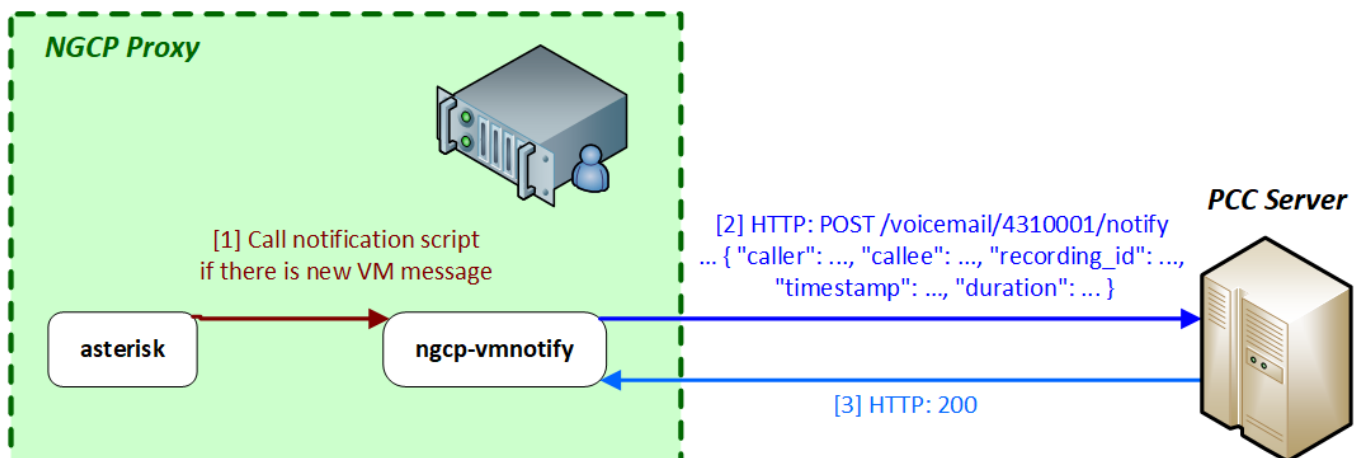

Figure 171: Voicemail Notification with PCC

1. The *asterisk* voicemail server triggers the *ngcp-vmnotify* script when a caller leaves a voicemail message in the callee's voicebox.
2. *ngcp-vmnotify* sends an HTTP *POST* request to the PCC server, as given in the example below:

```
POST /voicemail/4310001/notify HTTP/1.1
Content-Type: application/json

{
  "caller": 4369912345,
```

```

    "callee": 4310001,
    "recording_id": 45235 ,
    "timestamp": "2017-06-13T14:21:17T+01:00",
    "duration": 17
  }

```

The target URL is: **/voicemail/<called_party_num>/notify**

- The PCC server replies with *200 OK* if it properly processed the request.

18.4.3.2 Using SMS

The Sipwise C5 also supports voicemail notifications in form of short messages, using the built-in SMS modules. In such a case the *ngcp-vmnotify* module will send an HTTP *POST* request to the REST API (Sipwise C5 Web), that will contain the short message and finally be stored in the central database. Afterwards the short message will be sent to the recipient by Sipwise C5 Proxy.

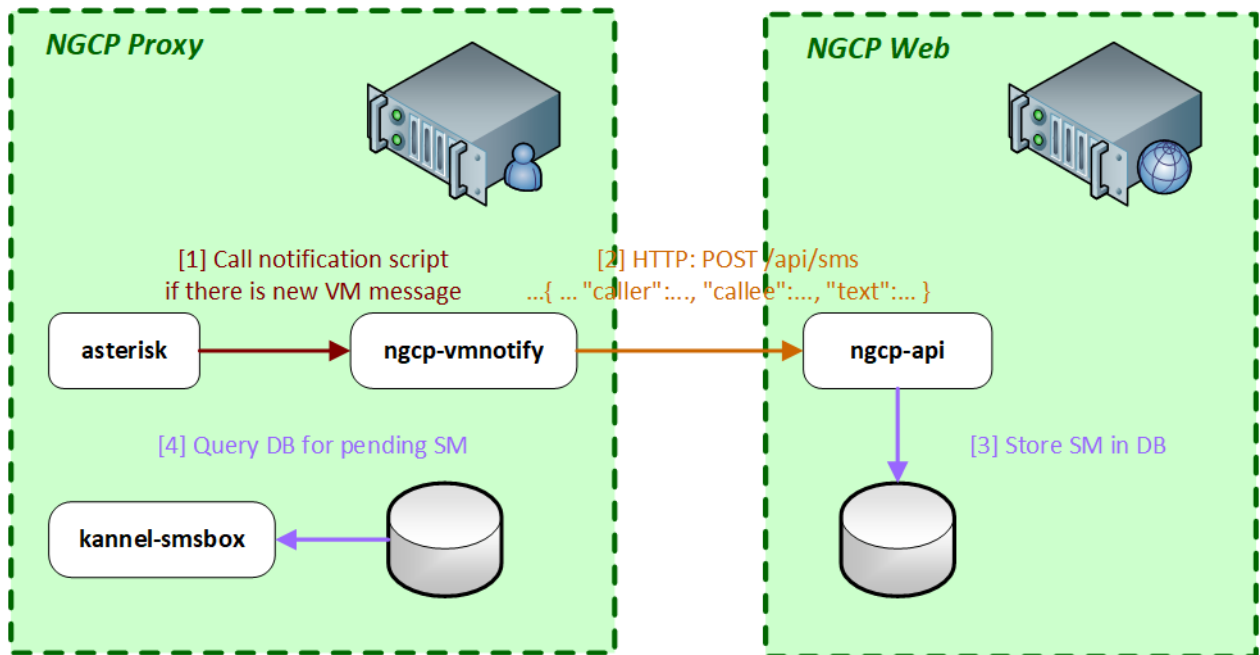

Figure 172: Voicemail Notification with SMS

- The *asterisk* voicemail server triggers the *ngcp-vmnotify* script when a caller leaves a voicemail message in the callee's voicebox.
- ngcp-vmnotify* sends an API request to *ngcp-api* module, as given in the example below:

```

POST /api/sms/?skip_checks=true&skip_journal=false HTTP/1.1
Content-Type: application/json

{

```

```

"subscriber_id": 90
"caller": 4369912345,
"callee" : 4310001,
"text": "user1 4310001 17 Tue 13 Jun 2017 14:21:17 +01:00"
}

```

The target URL is: `/api/sms`

3. The `ngcp-api` stores the message in the database.
4. The `kannel-smsbox` module of Sipwise C5 Proxy will query the database for messages waiting for delivery and send the SM to its recipient through Sipwise C5 LB.

18.4.4 Incoming Short Message Acceptance

18.4.4.1 Indicating Incoming SM to PCC Server

The PCC server may also serve as a control point for incoming short messages. The Sipwise C5 may indicate an incoming SM to the PCC server, which in turn must explicitly accept the message, so that the message will be forwarded to the recipient.

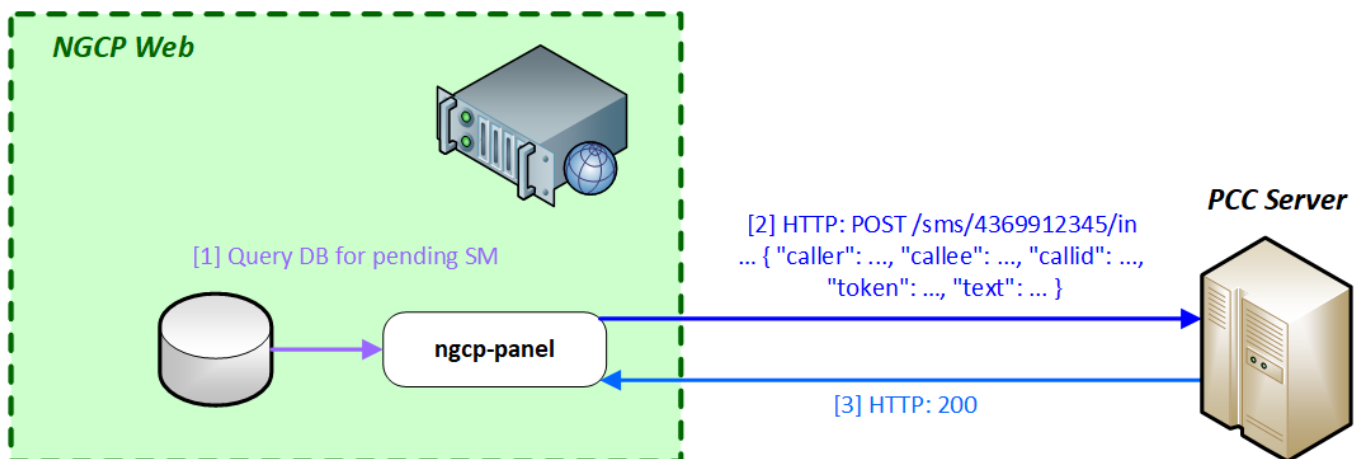

Figure 173: Short Message Notification with PCC

1. The `ngcp-panel` module on Sipwise C5 Web component will query the central database for pending incoming SMs.
2. The `ngcp-panel` will send an HTTP `POST` request to the PCC server if there is a message waiting for a subscriber. An example of such request is shown here:

```

POST /sms/4310001/in HTTP/1.1
Content-Type: application/json

{
  "caller": 4369912345,
  "callee": 4310001,

```

```

    "token": "PCC-aijfeoi",
    "callId": "abcd",
    "text": "This is the SM text"
  }

```

The target URL in this case is: `/sms/<called_party_num>/in`

- The PCC server replies with `200 OK` HTTP status if it properly understood the request.

18.4.4.2 Incoming SM Accepted by PCC Server

As in the case of an incoming call, the PCC server will send an HTTP `POST` request to the REST API of NGCP, in order to signal the acceptance of the SM.

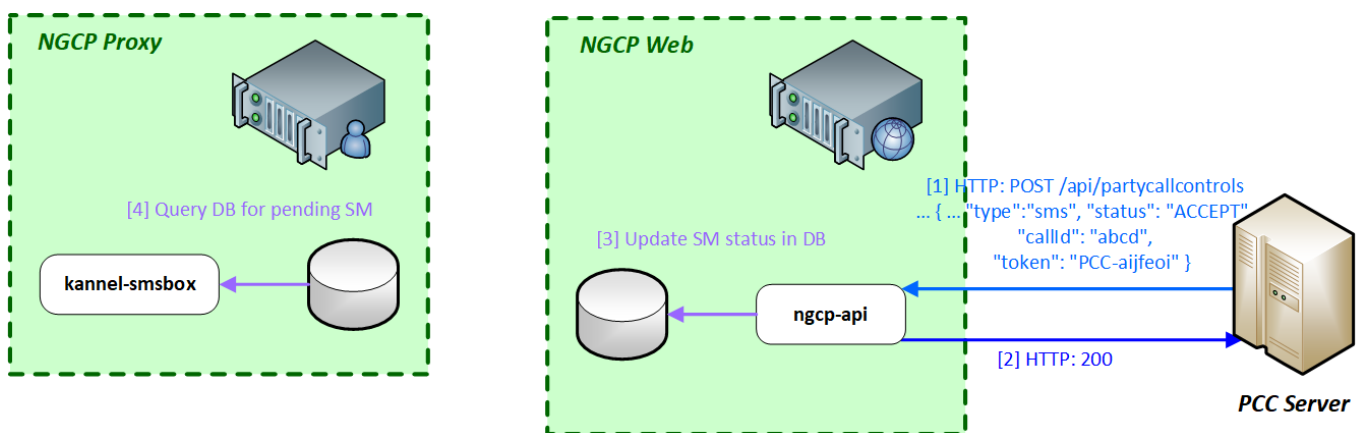

Figure 174: Short Message Accepted by PCC

- The PCC server sends the request to Sipwise C5 Web component, where `ngcp-api` module will process it. An example:

```

POST /api/partycallcontrols HTTP/1.1
Content-Type: application/json

{
  "type": "sms",
  "caller": 4369912345,
  "callee": 4310001,
  "status": "ACCEPT",
  "callId": "abcd",
  "token": "PCC-aijfeoi"
}

```

The target URL of the request: `/api/partycallcontrols`. The `type` parameter must have a value of `sms`.

- The `ngcp-api` module responds with `200 OK` HTTP status if it properly understood the request.

3. The *ngcp-api* updates the status of the SM in the database so that the SM may be forwarded to the recipient.
4. The *kannel-smsbox* module on Sipwise C5 Proxy will query the central database for SMs to be delivered and will forward the SM towards an SMSC, via Sipwise C5 LB.

18.4.5 Configuration of PCC

The configuration of the PCC feature is done via the main configuration file: `/etc/ngcp-config/config.yml`. The relevant section is: `apps.party_call_control`, the example below shows the default values of the parameters.

```
apps:
  party_call_control:
    accepted_reply: 200*
    enable: no
    pcc_server_url: https://127.0.0.1:9090/pcc/${prefix}${callee}${suffix}
    request_timeout: '30'
    trigger_on_hangup: yes
```

The configuration parameters are:

- `accepted_reply`: defines the value of `status` data element (in the PCC server's `POST` request sent to `/api/partycallcont` API resource) that means the "accepted" status of the call. For instance the handbook showed the value `ACCEPT` in previous sections, instead of the default `200*`
- `enable`: must be set to `yes` in order to enable the PCC feature
- `pcc_server_url`: the URL, pointing to the PCC server, where HTTP `POST` requests must be sent. The variables `${prefix}`, `${callee}` and `${suffix}` will be replaced with actual values when a request is sent. *Please do not change* this part of the URL! Possible values are:
 - `prefix = calls, suffix = initiate`
 - `prefix = calls, suffix = terminate`
 - `prefix = voicemail, suffix = notify`
 - `prefix = sms, suffix = in`
 - `callee = <called_party_num>`
- `request_timeout`: time in seconds until Sipwise C5 will wait for an HTTP reply from the PCC server, once Sipwise C5 has sent a request to it
- `trigger_on_hangup`: if set to `yes`, Sipwise C5 will send a "terminate" request to the PCC server at the end of the call

18.4.6 Troubleshooting of PCC

The Sipwise C5 will provide logs of its activities that are very useful for troubleshooting the call processing with PCC feature. This section will provide examples from various log files that can help to find potential problems in call setup.

18.4.6.1 Kamailio Proxy Log

PCC activation at *ngcp-sems* module

```
Oct 17 17:00:45 prx01a proxy[3206]: NOTICE: <script>: Call to PCC (Party Call Control) - R= ←
sip:2133339@192.168.10.11:5060;user=phone ID=1849964028_125696279@10.0.0.121 UA='<null>'
```

Call accepted by PCC server

```
Oct 17 17:00:16 prx01a proxy[3210]: NOTICE: <script>: NAT-Reply - S=301 - Accepted M=INVITE ←
IP=192.168.10.12:5080 (192.168.10.12:5080) ID=1850250074_83465152@10.0.0.121 UA='<null>' ←
'
Oct 17 17:00:16 prx01a proxy[3210]: INFO: <script>: Received 200 OK (Accepted) from PCC ←
Server, routing the call to its original callee - ID=1850250074_83465152@10.0.0.121 UA=' ←
<null>'
```

18.4.6.2 SEMS Log

Initiate call at PCC

```
Oct 17 17:10:47 prx01a sems[5059]: [#7f73237f7700] [mod_py_log, PyDSM.cpp:42] INFO: PCC ←
http request to http://example.com/pcc/calls/4366811112222/initiate - callid 1851794724 ←
_134068006@10.0.0.121
Oct 17 17:10:47 prx01a sems[5059]: [#7f73237f7700] [mod_py_log, PyDSM.cpp:42] INFO: PCC ←
form data: {'actualMsisdn': '4369933334444', 'actualClir': '0', 'token': 'PCC-12DBBD25 ←
-59E61D770001841C-237F7700', 'callingMsisdn': '4366811112222', 'callId': '1851794724 ←
_134068006@10.0.0.121'} - callid 1851794724_134068006@10.0.0.121
Oct 17 17:10:47 prx01a sems[5059]: [#7f73237f7700] [mod_py_log, PyDSM.cpp:42] INFO: PCC ret ←
: 0 num_handles: 1
Oct 17 17:10:47 prx01a sems[5059]: [#7f73237f7700] [mod_py_log, PyDSM.cpp:42] INFO: RT: 0 1 ←
0 [] []
...
Oct 17 17:10:47 prx01a sems[5059]: [#7f73237f7700] [mod_py_log, PyDSM.cpp:42] INFO: RT: 0 0 ←
0 [<pycurl.Curl object at 0x7f7378067c50>] []
Oct 17 17:10:47 prx01a sems[5059]: [#7f73237f7700] [mod_py_log, PyDSM.cpp:42] INFO: PCC ←
reply for callid 1851794724_134068006@10.0.0.121: 200
```

Call accepted by PCC server

```
Oct 17 17:10:51 prx01a sems[5059]: [#7f7323efe700] [execute, XMLRPC2DI.cpp:714] INFO: ←
XMLRPC2DI 'postDSMEvent': function 'postDSMEvent'
```

```

Oct 17 17:10:51 prx01a sems[5059]: [#7f7323efe700] [execute, XMLRPC2DI.cpp:718] INFO: ←
params: <['PCC-12DBBD25-59E61D770001841C-237F7700', [['cmd', 'handleCall'], ['callid', ←
'1851794724_134068006@10.0.0.121'], ['caller', '4369933334444'], ['callee', ←
'4366811112222'], ['status', 'ACCEPT']]>
Oct 17 17:10:51 prx01a sems[5059]: [#7f7323efe700] [execute, XMLRPC2DI.cpp:724] INFO: ←
result: <[200, 'OK']>
Oct 17 17:10:51 prx01a sems[5059]: [#7f73237f7700] [execute, DSMCoreModule.cpp:521] INFO: ←
FSM: 'PCC RESULT -- ACCEPT'

```

Terminate call at PCC

```

Oct 17 17:10:53 prx01a sems[5059]: [#7f73235f5700] [mod_py_log, PyDSM.cpp:42] INFO: PCC ←
http request to http://example.com/pcc/calls/4366811112222/terminate - callid 1851794724 ←
_134068006@10.0.0.121
Oct 17 17:10:53 prx01a sems[5059]: [#7f73235f5700] [mod_py_log, PyDSM.cpp:42] INFO: PCC ←
form data: {'actualMsisdn': '4369933334444', 'callId': '1851794724_134068006@10 ←
.0.0.121', 'callingMsisdn': '4366811112222', 'reason': 'CANCEL', 'token': 'PCC-12DBBD25 ←
-59E61D770001841C-237F7700', 'actualClir': '0'} - callid 1851794724_134068006@10.0.0.121

```

18.4.6.3 Sipwise C5 Panel Log

SM notification at PCC server

```

Oct 18 09:10:16 web01a ngcp-panel: INFO: pcc is set to 1 for prov subscriber id 18451
Oct 18 09:10:16 web01a ngcp-panel: INFO: >>>> source check for booking.com passed, continue ←
with time check
Oct 18 09:10:16 web01a ngcp-panel: INFO: >>>> time check for 1508310615 passed, use ←
destination set
Oct 18 09:10:16 web01a ngcp-panel: INFO: >>>> proceed sms forwarding
Oct 18 09:10:16 web01a ngcp-panel: INFO: >>>> forward sms to 4369933334444
Oct 18 09:10:16 web01a ngcp-panel: INFO: sending pcc request for sms with id 305125 to http ←
://example.com/pcc/sms/4366811112222/in
Oct 18 09:10:16 web01a ngcp-panel: INFO: sending pcc request succeeded
Oct 18 09:10:16 web01a ngcp-panel: INFO: status for pcc sms of 305125 is BUSY, don't ←
forward sms

```

In the last line the status is BUSY. The purpose of this is to prevent forwarding the SM to the mobile phone of the recipient. Otherwise, in order to let Sipwise C5 forward the message to the recipient, the status is ACCEPT.

18.4.6.4 REST API Log

Call accepted by PCC server

```
Oct 18 10:19:39 web01a ngcp-panel: INFO: IP=192.168.10.20 CALLED=API[POST]/api/ ↔
partycallcontrols/ TX=14EE9C4CD2599A70 USER=username DATA={} MSG="" LOG="{\"type\":\"pcc\", \"
caller\":\"4365033334444\", \"callee\":\"4366811112222\", \"status\":\"ACCEPT\", \"token\":\"PCC-273C2CDA
-59E70E96000BE0C4-231F1700\", \"callid\":\"406885946_117428858@10.0.0.121\"}"
Oct 18 10:19:39 web01a ngcp-panel: INFO: IP=192.168.10.20 CALLED=API[POST 200]/api/ ↔
partycallcontrols/ TX=14EE9C4CD2599A70 USER=username DATA={} MSG="" LOG=""
```

SM accepted by PCC server

```
Oct 18 10:20:30 web01a ngcp-panel: INFO: IP=192.168.10.20 CALLED=API[POST]/api/ ↔
partycallcontrols/ TX=14EE9C58CEA4D960 USER=username DATA={} MSG="" LOG="{\"type\":\"sms\", \"
caller\":\"155566666\", \"callee\":\"4366811112222\", \"status\":\"ACCEPT\", \"token\":\"1482d9e2-a9fc-40
ee-bdaf-de6f7fc239f8\", \"callid\":\"305175\"}"
Oct 18 10:20:30 web01a ngcp-panel: INFO: IP=192.168.10.20 CALLED=API[POST 200]/api/ ↔
partycallcontrols/ TX=14EE9C58CEA4D960 USER=username DATA={} MSG="" LOG=""
```

18.4.6.5 Voicemail Notification Log

The voicemail notifier program (`ngcp-vmnotify`) writes its log messages into the system log (`/var/log/syslog`). An example:

```
Oct 18 09:53:34 prx01a vmnotify[20072]: Arguments: default 4366811112222 1 0 0 0 ↔
4365033334444 2017-10-18T09:53:34+0200 8
```

Where the *Arguments* are:

- default: Asterisk voicemail context
- the voicemail box owner
- 1: number of new messages
- 0: number of old messages
- 0: number of urgent messages
- 0: message ID of the latest message
- who left the message (caller)
- date and time of the message
- 8: duration of the message in seconds

A Basic Call Flows

A.1 General Call Setup

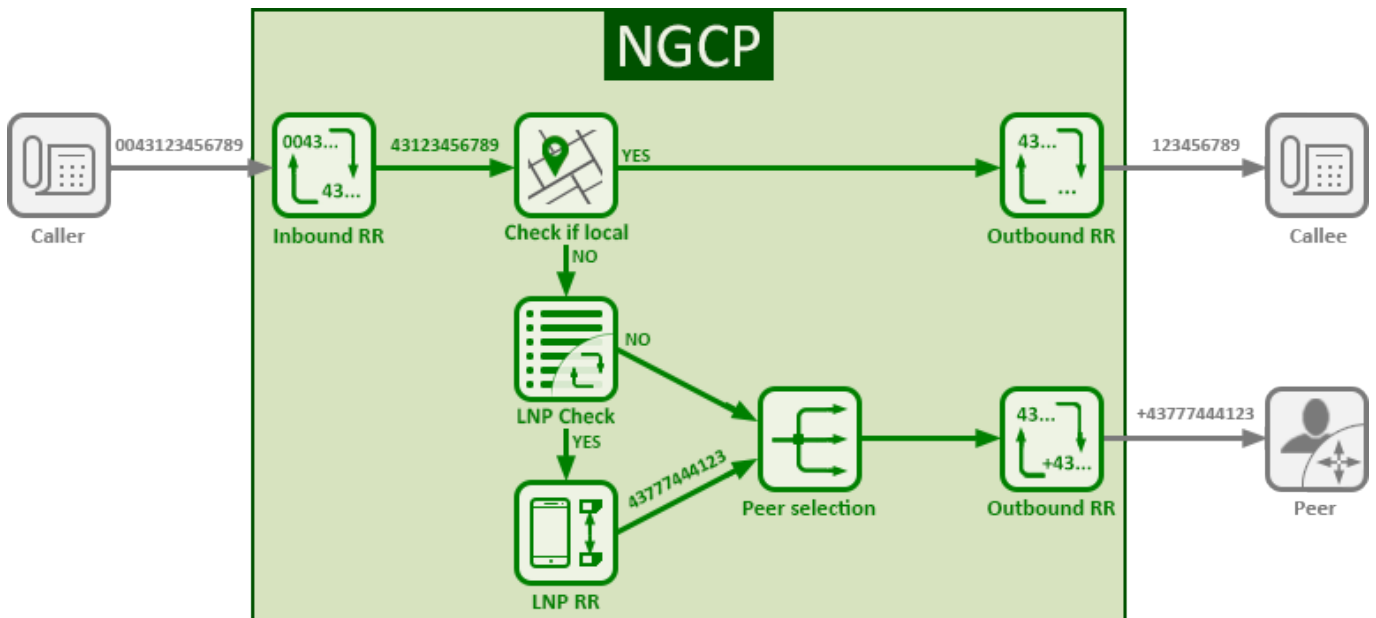

Figure 175: General Call Setup

Sipwise C5 performs the following checks when processing a call coming from a subscriber and terminated at a peer:

- Checks if the IP address where the request came from is in the list of trusted IP addresses. If yes, this IP address is taken as the identity for authentication. Otherwise, Sipwise C5 performs the digest authentication.
- When the subscriber is authorized to make the call, Sipwise C5 applies the Inbound Rewrite Rules for the caller and the callee assigned to the subscriber (if any). If there are no Rewrite Rules assigned to the subscriber, the ones assigned to the subscriber's domain are applied. On this stage the platform normalises the numbers from the subscriber's format to E.164.
- Matches the callee (called number) with local subscribers.
 - If it finds a matching subscriber, the call is routed internally. In this case, Sipwise C5 applies the Outbound Rewrite Rules associated with the callee (if any). If there are no Rewrite Rules assigned to the callee, the ones assigned to the callee's domain are applied.
 - If it does not find a matching subscriber, the call goes to a peer as described below.
- Queries the LNP database to find out if the number was ported or not. For details of LNP queries refer to the [Local Number Porting](#) chapter.
 - If it was ported, Sipwise C5 applies the LNP Rewrite Rules to the called number.
- Based on the priorities of peering groups and peering rules (see Section [5.6.2.3](#) for details), Sipwise C5 selects peering groups for call termination and defines their precedence.

- Within every peering group the weight of a peering server defines its probability to receive the call for termination. Thus, the bigger the weight of a server, the higher the probability that Sipwise C5 will send the call to it.
- Applies the Outbound Rewrite Rules for the caller and the callee assigned to a peering server when sending the call to it.

A.2 Endpoint Registration

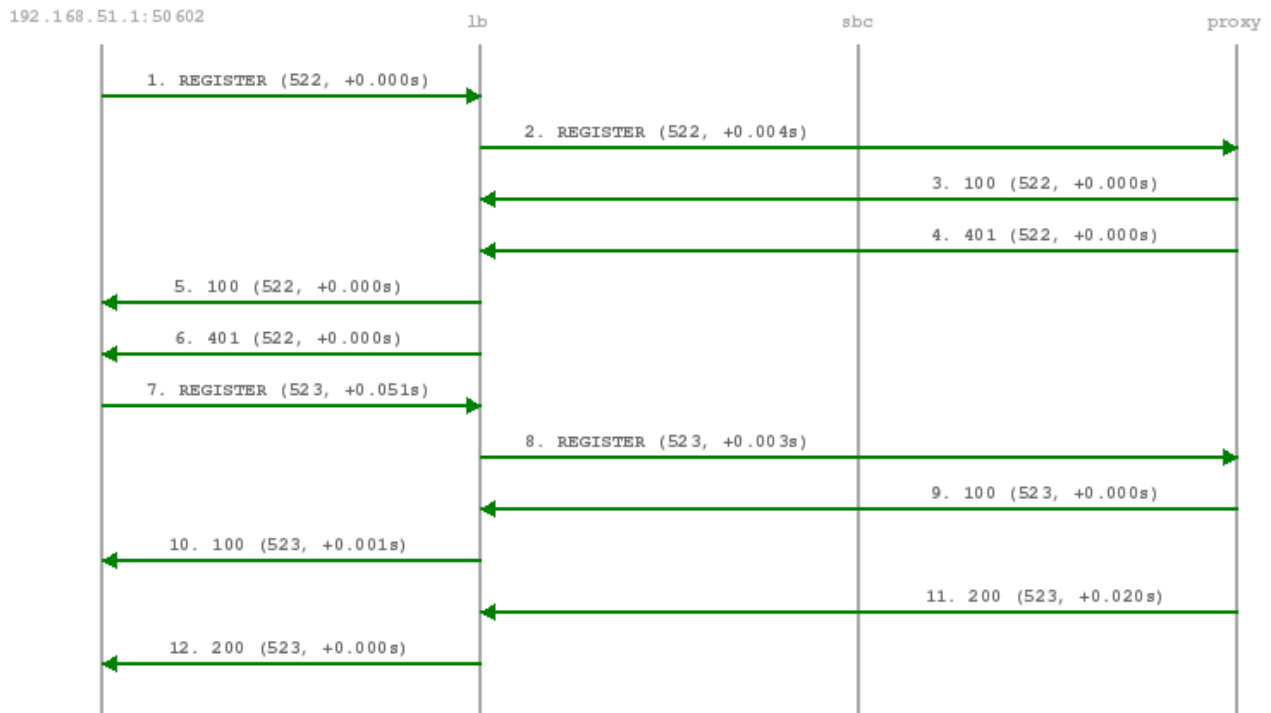

Figure 176: Registration Call-Flow

The subscriber endpoint starts sending a REGISTER request, which gets challenged by a 401. After calculating the response of the authentication challenge, it sends the REGISTER again, including the authentication response. The SIP proxy looks up the credentials of the subscriber in the database, does the same calculation, and if the result matches the one from the subscriber, the registration is granted.

The SIP proxy writes the content of the Contact header (e.g. sip:me@1.2.3.4:1234;transport=UDP) into its location table (in case of NAT the content is changed by the SIP load-balancer to the IP/port from where the request was received), so it knows where to reach a subscriber in case of an inbound call to this subscriber (e.g. sip:someuser@example.org is mapped to sip:me@1.2.3.4:1234;transport=UDP and sent out to this address).

If NAT is detected, the SIP proxy sends a OPTION message to the registered contact every 30 seconds, in order to keep the NAT binding on the NAT device open. Otherwise, for subsequent calls to this contact, Sipwise C5 wouldn't be able to reach the endpoint behind NAT (NAT devices usually drop a UDP binding after not receiving any traffic for ~30-60 seconds).

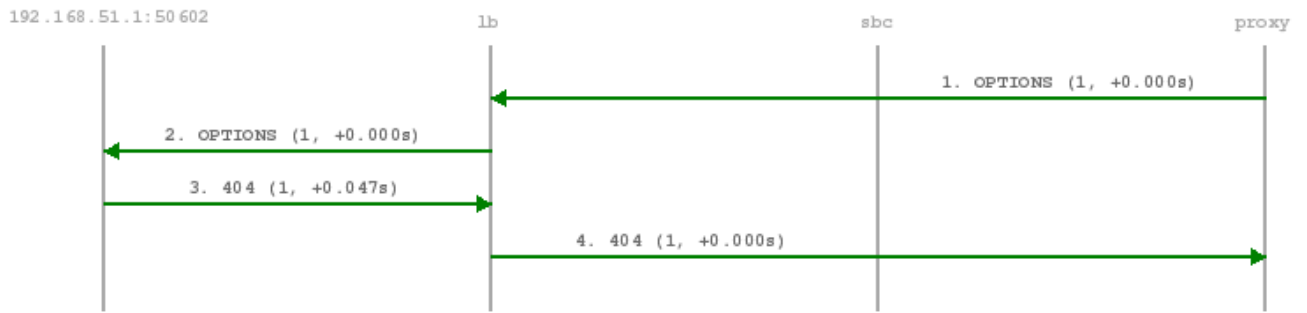

Figure 177: NAT-Ping Call-Flow

By default, a subscriber can register 5 contacts for an Address of Record (AoR, e.g. sip:someuser@example.org).

A.3 Basic Call

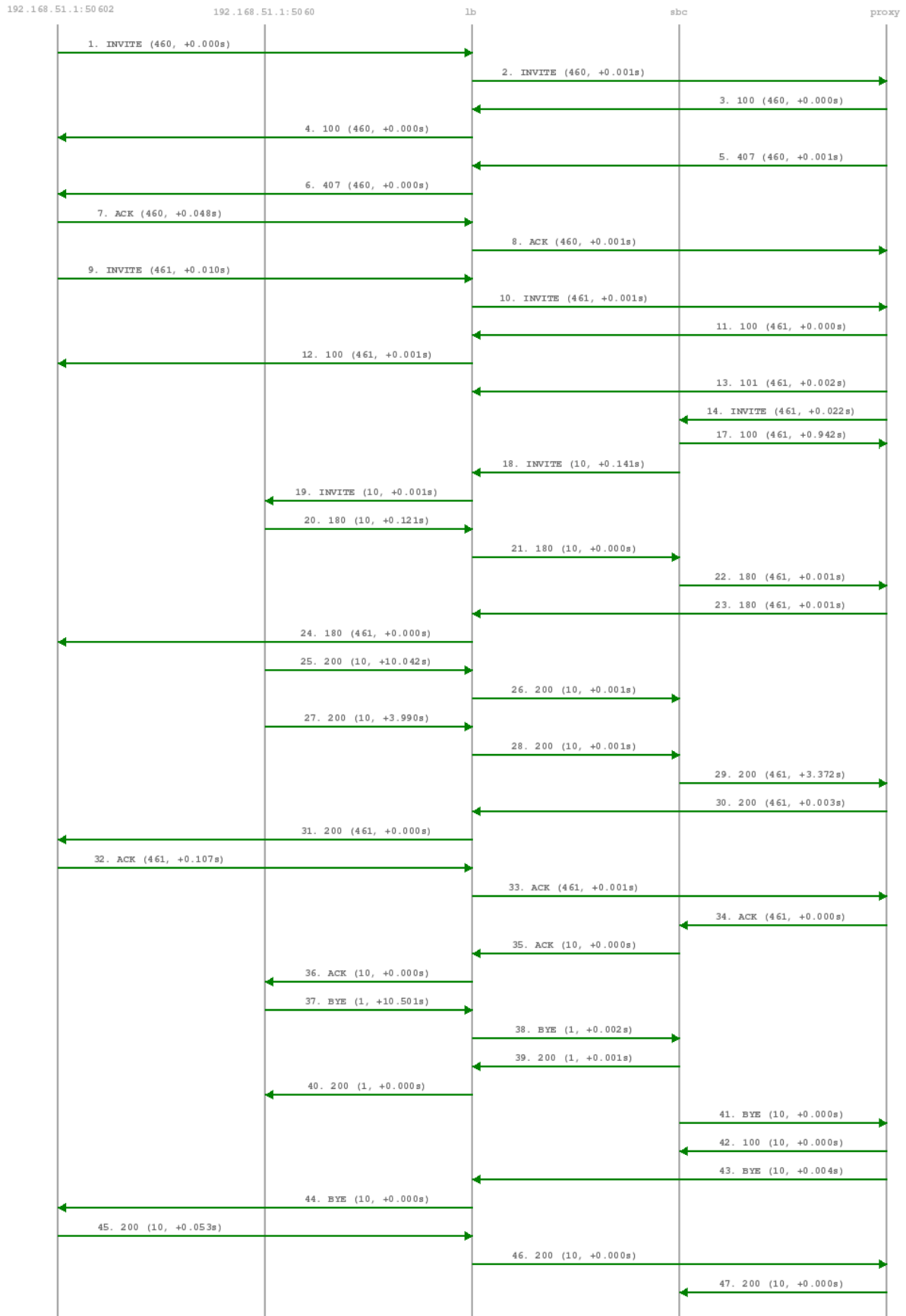

Figure 178: Basic Call Call-Flow

The calling party sends an INVITE (e.g. `sip:someuser@example.org`) via the SIP load-balancer to the SIP proxy. The proxy replies with an authorization challenge in the 407 response, and the calling party sends the INVITE again with authentication credentials. The SIP proxy checks if the called party is a local user. If it is, and if there is a registered contact found for this user, then (after various feature-related tasks for both the caller and the callee) the Request-URI is replaced by the URI of the registered contact (e.g. `sip:me@1.2.3.4:1234;transport=UDP`). If it's not a local user but a numeric user, a proper PSTN gateway is being selected by the SIP proxy, and the Request-URI is rewritten accordingly (e.g. `sip:+43123456789@2.3.4.5:5060`).

Once the proxy has finished working through the call features of both parties involved and has selected the final destination for the call, and - optionally - has invoked the Media Relay for this call, the INVITE is sent to the SIP B2BUA. The B2BUA creates a new INVITE message from scratch (using a new Call-ID and a new From-Tag), copies only various and explicitly allowed SIP headers from the old message to the new one, filters out unwanted media capabilities from the SDP body (e.g. to force audio calls to use G.711 as a codec) and then sends the new message via the SIP load-balancer to the called party.

SIP replies from the called party are passed through the elements back to the calling party (replacing various fields on the B2BUA to match the first call leg again). If a reply with an SDP body is received by the SIP proxy (e.g. a 183 or a 200), the Media Relay is invoked again to prepare the ports for the media stream.

Once the 200 is routed from the called party to the calling party, the media stream is fully negotiated, and the endpoints can start sending traffic to each other (either end-to-end or via the Media Relay). Upon reception of the 200, the SIP proxy writes a start record for the accounting process. The 200 is also acknowledged with an ACK message from the calling party to the called party, according to the SIP 3-way handshake.

Either of the parties can tear down the media session at any time by sending a BYE, which is passed through to the other party. Once the BYE reaches the SIP proxy, it instructs the Media Relay to close the media ports, and it writes a stop record for accounting purposes. Both the start- and the stop-records are picked up by the *ngcp-mediator* service in a regular interval and are converted into a Call Detail Record (CDR), which will be rated by the *ngcp-rate-o-mat* process and can be billed to the calling party. For calls made by subscribers on a prepaid plan, rating occurs at call runtime and is actually done by the B2BUA (which is necessary to properly support multiple parallel calls by the same subscriber). The final rating data is then passed on to *ngcp-rate-o-mat* which will update the CDRs accordingly.

A.4 Session Keep-Alive

The SIP B2BUA acts as refresher for the Session-Timer mechanism as defined in RFC 4028. If the endpoints indicate support for the UPDATE method during call-setup, then the SIP B2BUA will use an UPDATE message if enabled per peer, domain or subscriber via Provisioning to check if the endpoints are still alive and responsive. Both endpoints can renegotiate the timer within a configurable range. All values can be tuned using the Admin Panel or the APIs using Peer-, Domain- and Subscriber-Preferences.

Tip

Keep in mind that the values being used in the signaling are always half the value being configured. So if you want to send a keep-alive every 300 seconds, you need to provision *sst_expires* to 600.

If one of the endpoints doesn't respond to the keep-alive messages or answers with `481 Call/Transaction Does Not Exist`, then the call is torn down on both sides. This mechanism prevents excessive over-billing of calls if one of the endpoints

is not reachable anymore or "forgets" about the call. The BYE message sent by the B2BUA triggers a stop-record for accounting and also closes the media ports on the Media Relay to stop the call.

Beside the Session-Timer mechanism to prevent calls from being lost or kept open, there is a **maximum call length** of 21600 seconds per default defined in the B2BUA. This is a security/anti-fraud mechanism to prevent overly long calls causing excessive costs.

A.5 Voicebox Calls

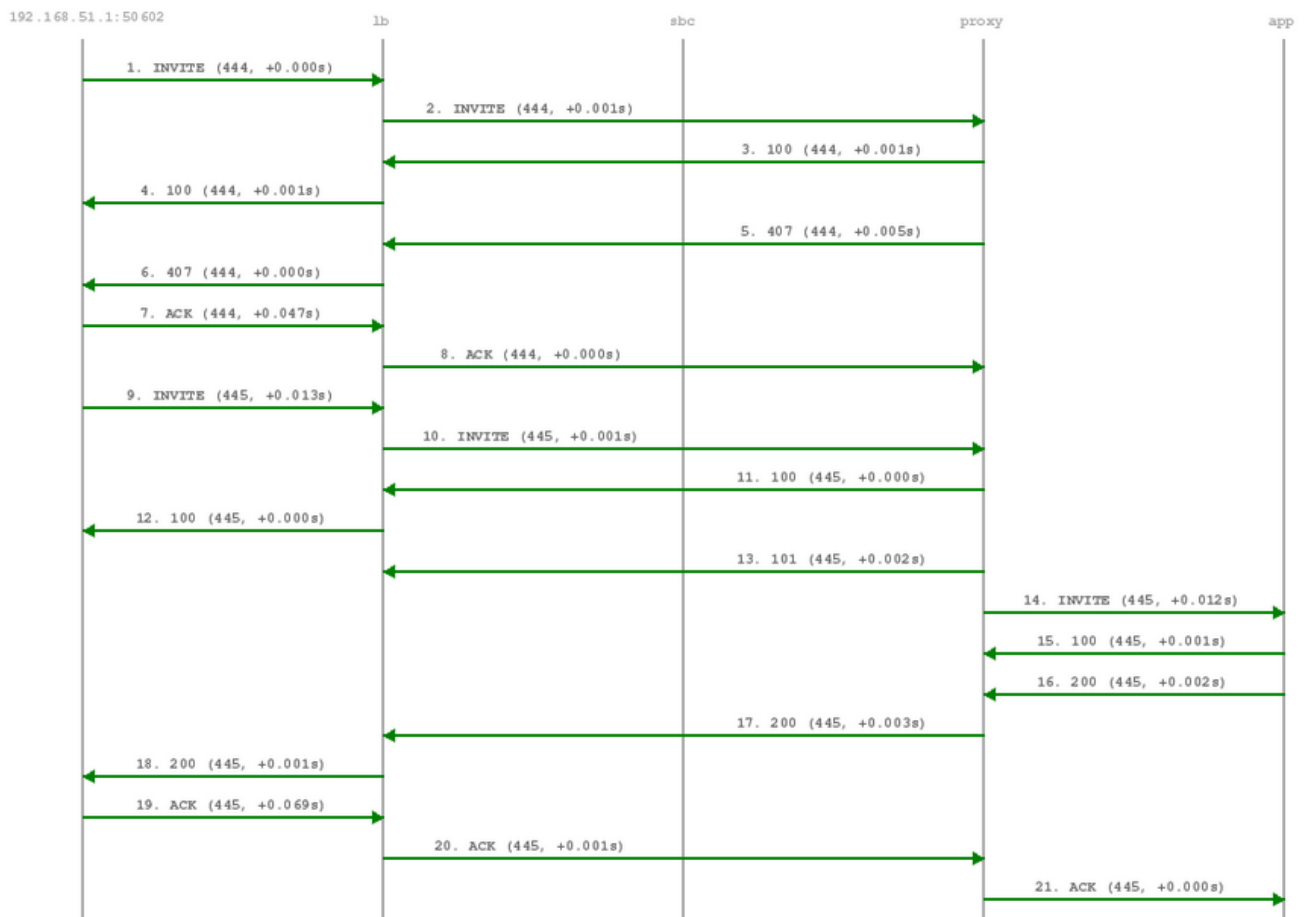

Figure 179: Voicebox Call-Flow

Calls to the Voicebox (both for callers leaving a voicemail message and for voicebox owners managing it via the IVR menu) are passed directly from the SIP proxy to the App-Server without a B2BUA. The App-Server maintains its own timers, so there is no risk of over-billing or overly long calls.

In such a case where an endpoint talks via the Media Relay to a system-internal endpoint, the Media Relay bridges the media streams between the public in the system-internal network.

In case of an endpoint leaving a new message on the voicebox, the Message-Waiting-Indication (MWI) mechanism triggers the sending of a unsolicited NOTIFY message, passing the number of new messages in the body. As soon as the voicebox owner

dials into his voicebox (e.g. by calling `sip:voicebox@example.org` from his SIP account), another NOTIFY message is sent to his devices, resetting the number of new messages.

**Important**

The Sipwise C5 does not require your device to subscribe to the MWI service by sending a SUBSCRIBE (it would rather reject it). On the other hand, the endpoints need to accept unsolicited NOTIFY messages (that is, a NOTIFY without a valid subscription), otherwise the MWI service will not work with these endpoints.

B Sipwise C5 configs overview

B.1 config.yml Overview

`/etc/ngcp-config/config.yml` is the main configuration YAML file used by Sipwise C5. After every changes it need to run the command `ngcpcfg apply "my commit message"` to apply changes (followed by `ngcpcfg push` in the PRO version to apply changes to sp2). The following is a brief description of the main variables contained into `/etc/ngcp-config/config.yml` file.

B.1.1 apps

This section contains parameters for the additional applications that may be activated on Sipwise C5.

```
apps:
  malicious_call: no
  party_call_control:
    accepted_reply: 200*
    enable: no
    pcc_server_url: https://127.0.0.1:9090/pcc/${prefix}${callee}${suffix}
    request_timeout: '30'
    trigger_on_hangup: yes
```

- `malicious_call`: If set to `yes`, the Malicious Call Identification (MCID) application will be enabled.
- `party_call_control.accepted_reply`: Defines the value of `status` data element that means the "accepted" status of the call.
- `party_call_control.enable`: Must be set to `yes` in order to enable the PCC feature.
- `party_call_control.pcc_server_url`: The URL, pointing to the PCC server, where HTTP `POST` requests must be sent. Do not change the variable references `${prefix}`, `${callee}` and `${suffix}`!
- `party_call_control.request_timeout`: Time in seconds until Sipwise C5 will wait for an HTTP reply from the PCC server, once Sipwise C5 has sent a request to it.
- `party_call_control.trigger_on_hangup`: If set to `yes`, Sipwise C5 will send a "terminate" request to the PCC server at the end of the call.

Tip

See the Section [18.4.5](#) section of the handbook for more details on PCC configuration.

B.1.2 asterisk

The following is the asterisk section:

```

asterisk:
  log:
    facility: local6
  rtp:
    maxport: 20000
    minport: 10000
  sip:
    bindport: 5070
    dtmfmode: rfc2833
  voicemail:
    enable: no
    fromstring: 'Voicemail server'
    greeting:
      busy_custom_greeting: '/home/user/file_no_extension'
      busy_overwrite_default: no
      busy_overwrite_subscriber: no
      unavail_custom_greeting: '/home/user/file_no_extension'
      unavail_overwrite_default: no
      unavail_overwrite_subscriber: no
    mailbody: 'You have received a new message from ${VM_CALLERID} in voicebox ${VM_MAILBOX} ←
      } on ${VM_DATE}.'
    mailsubject: '[Voicebox] New message ${VM_MSGNUM} in voicebox ${VM_MAILBOX}'
    max_msg_length: 180
    maxgreet: 60
    maxmsg: 30
    maxsilence: 0
    min_msg_length: 3
    normalize_match: '^00|\+([1-9][0-9]+)$'
    normalize_replace: '$1'
    serveremail: voicebox@sip.sipwise.com

```

- `log.facility`: rsyslog facility for asterisk log, defined in `/etc/asterisk/logger.conf`.
- `rtp.maxport`: RTP maximum port used by asterisk.
- `rtp.minport`: RTP minimum port used by asterisk.
- `sip.bindport`: SIP asterisk internal bindport.
- `voicemail.greetings.*`: set the audio file path for voicemail custom unavailable/busy greetings
- `voicemail.mailbody`: Mail body for incoming voicemail.
- `voicemail.mailsubject`: Mail subject for incoming voicemail.
- `voicemail.max_msg_length`: Sets the maximum length of a voicemail message, in seconds.
- `voicemail.maxgreet`: Sets the maximum length of voicemail greetings, in seconds.

- `voicemail.maxmsg`: Sets the maximum number of messages that may be kept in any voicemail folder.
- `voicemail.min_msg_length`: Sets the minimum length of a voicemail message, in seconds.
- `voicemail.maxsilence`: Maxsilence defines how long Asterisk will wait for a contiguous period of silence before terminating an incoming call to voice mail. The default value is 0, which means the silence detector is disabled and the wait time is infinite.
- `voicemail.serveremail`: Provides the email address from which voicemail notifications should be sent.
- `voicemail.normalize_match`: Regular expression to match the From number for calls to voicebox.
- `voicemail.normalize_replace`: Replacement string to return, in order to match an existing voicebox.

B.1.3 autoprov

The following is the autoprovisioning section:

```
autoprov:
  hardphone:
    skip_vendor_redirect: no
  server:
    bootstrap_port: 1445
    ca_certfile: '/etc/ngcp-config/ssl/client-auth-ca.crt'
    host: localhost
    port: 1444
    server_certfile: '/etc/ngcp-config/ssl/myserver.crt'
    server_keyfile: '/etc/ngcp-config/ssl/myserver.key'
    ssl_enabled: yes
  softphone:
    config_lockdown: 0
    webauth: 0
```

- `autoprov.skip_vendor_redirect`: Skip phone vendor redirection to the vendor provisioning web site.

B.1.4 backuptools

The following is the backup tools section:

```
backuptools:
  cdrexport_backup:
    enable: no
  etc_backup:
    enable: no
  mail:
    address: noc@company.org
```

```

error_subject: '[ngcp-backup] Problems detected during daily backup'
log_subject: '[ngcp-backup] Daily backup report'
send_errors: no
send_log: no
mysql_backup:
  enable: no
  exclude_dbs: 'syslog sipstats information_schema'
rotate_days: 7
storage_dir: '/ngcp-data/backup/ngcp_backup'
temp_backup_dir: '/ngcp-data/backup/ngcp_backup/tmp'

```

- `backuptools.cdrexport_backup.enable`: Enable backup of `cdrexport (.csv)` directory.
- `backuptools.etc_backup.enable`: Enable backup of `/etc/*` directory.
- `backuptools.mail.address`: Destination email address for backup emails.
- `backuptools.mail.error_subject`: Subject for error emails.
- `backuptools.mail.log_subject`: Subject for daily backup report.
- `backuptools.mail.send_error`: Send daily backup error report.
- `backuptools.mail.send_log`: Send daily backup log report.
- `backuptools.mysql_backup.enable`: Enable daily mysql backup.
- `backuptools.mysql_backup.exclude_dbs`: exclude mysql databases from backup.
- `backuptools.rotate_days`: Number of days backup files should be kept. All files older than specified number of days are deleted from the storage directory.
- `backuptools.storage_dir`: Storage directory of backups.
- `backuptools.storage_group`: Name of the group that backup files should be owned by.
- `backuptools.storage_user`: Name of the user that backup files should be owned by.
- `backuptools.temp_backup_dir`: Temporary storage directory of backups.

B.1.5 bootenv

The following is the `bootenv` section:

```

bootenv:
  dhcp:
    boot: '/srv/tftp/pxelinux.0'
    enable: yes
    end: 192.168.1.199

```

```
expire: 12h
start: 192.168.1.101
http_port: 3000
http_proxy: ''
https_proxy: ''
ro_port: 9998
rw_port: 9999
tftp:
  enable: yes
  root: '/srv/tftp'
```

- `bootenv.dhcp.enable`: enable dnsmasq DHCP server
- `bootenv.dhcp.boot`: PXE image boot location
- `bootenv.dhcp.start`: first IP of DHCP scope
- `bootenv.dhcp.end`: last IP of DHCP scope
- `bootenv.dhcp.expire`: DHCP leasing expiration
- `bootenv.http_port`: HTTP port for iPXE boot files/configs
- `bootenv.http_proxy`: HTTP proxy to access Sipwise Debian repositories
- `bootenv.https_proxy`: HTTPS proxy to access Sipwise Debian repositories
- `bootenv.ro_port`: HTTP port for read-only access to Approx cache
- `bootenv.rw_port`: HTTP port for read-write access to Approx cache
- `bootenv.tftp.enable`: enable tftp server for PXE boot
- `bootenv.tftp.root`: root folder for tftp server

B.1.6 cdrexpert

The following is the cdr export section:

```
cdrexpert:
  daily_folder: yes
  export_failed: no
  export_incoming: no
  exportpath: '/home/jail/home/cdrexpert'
  full_names: yes
  monthly_folder: yes
```

- `cdrexpert.daily_folder`: Set yes if you want to create a daily folder for CDRs under the configured path.

- `cdrexport.export_failed`: Export CDR for failed calls.
- `cdrexport.export_incoming`: Export CDR for incoming calls.
- `cdrexport.exportpath`: The path to store CDRs in .csv format.
- `cdrexport.full_names`: Use full namen for CDRs instead of short ones.
- `cdrexport.monthly_folder`: Set `yes` if you want to create a monthly folder (ex. 201301 for January 2013) for CDRs under configured path.

B.1.7 cleanuptools

The following is the cleanup tools section:

```
cleanuptools:
  acc_cleanup_days: 90
  archive_targetdir: '/ngcp-data/backups/cdr'
  binlog_days: 15
  cdr_archive_months: 2
  cdr_backup_months: 2
  cdr_backup_retro: 3
  compress: gzip
  delete_old_cdr_files:
    enable: no
    max_age_days: 30
    paths:
      -
        max_age_days: ~
        path: '/home/jail/home/*/20[0-9][0-9][0-9][0-9]/[0-9][0-9]'
        remove_empty_directories: yes
        wildcard: yes
      -
        max_age_days: ~
        path: '/home/jail/home/cdreexport/resellers/*/20[0-9][0-9][0-9][0-9]/[0-9][0-9]'
        remove_empty_directories: yes
        wildcard: yes
      -
        max_age_days: ~
        path: '/home/jail/home/cdreexport/system/20[0-9][0-9][0-9][0-9]/[0-9][0-9]'
        remove_empty_directories: yes
        wildcard: yes
  sql_batch: 10000
  trash_cleanup_days: 30
```

- `cleanuptools.acc_cleanup_days`: CDR records in `acc` table in `kamailio` database will be deleted after this time

- `cleantools.binlog_days`: Time after MySQL binlogs will be deleted.
- `cleantools.cdr_archive_months`: How many months worth of records to keep in monthly CDR backup tables, instead of dumping them into archive files and dropping them from database.
- `cleantools.cdr_backup_months`: How many months worth of records to keep in the current `cdr` table, instead of moving them into the monthly CDR backup tables.
- `cleantools.cdr_backup_retro`: How many months to process for backups, going backwards in time and skipping `cdr_backup_months` months first, and store them in backup tables. Any older record will be left untouched.
- `cleantools.delete_old_cdr_files`:
 - `enable`: Enable (`yes`) or disable (`no`) exported CDR cleanup.
 - `max_age_days`: Gives the expiration time of the exported CDR files in days. There is a general value which may be overridden by a local value provided at a specific path. The local value is valid for the particular path only.
 - `paths`: an array of path definitions
 - * `path`: a path where CDR files are to be found and deleted; this may contain wildcard characters
 - * `wildcard`: Enable (`yes`) or disable (`no`) using wildcards in the `path`
 - * `remove_empty_directories`: Enable (`yes`) or disable (`no`) removing empty directories if those are found in the given `path`
 - * `max_age_days`: the local expiration time value for files in the particular `path`
- `cleantools.sql_batch`: How many records to process within a single SQL statement.
- `cleantools.trash_cleanup_days`: Time after CDRs from `acc_trash` and `acc_backup` tables in `kamailio` database will be deleted.

For the description of `cleantools` please visit [Cleanuptools Description](#) section of the handbook.

B.1.8 cluster_sets

The following is the cluster sets section:

```
cluster_sets:
  default:
    dispatcher_id: 50
    default_set: default
    type: central
```

- `cluster_sets.<label>`: an arbitrary label of the cluster set; in the above example we have `default`
- `cluster_sets.<label>.dispatcher_id`: a unique, numeric value that identifies a particular cluster set
- `cluster_sets.default_set`: selects the default cluster set
- `cluster_sets.type`: the type of cluster set; can be `central` or `distributed`

B.1.9 database

The following is the database section:

```
database:
  bufferpoolsize: 24768M
```

- `database.bufferpoolsize`: InnoDB `buffer_pool_size` value in `/etc/mysql/my.cnf`

B.1.10 faxserver

The following is the fax server section:

```
faxserver:
  enable: yes
  fail_attempts: '3'
  fail_retry_secs: '60'
  mail_from: 'Sipwise C5 FaxServer <voipfax@ngcp.sipwise.local>'
```

- `faxserver.enable`: *yes/no* to enable or disable `ngcp-faxserver` on the platform respectively.
- `faxserver.fail_attempts`: Amount of attempts to send a fax after which it is marked as *failed*.
- `faxserver.fail_retry_secs`: Amount of seconds to wait between "fail_attempts".
- `faxserver.mail_from`: Sets the e-mail From Header for incoming fax.

B.1.11 general

The following is the general section:

```
general:
  adminmail: adjust@example.org
  companyname: sipwise
  lang: en
  maintenance: no
  production: yes
  timezone: localtime
```

- `general.adminmail`: Email address used by `monit` to send notifications to.

- `general.companyname`: Label used in SNMPd configuration.
- `general.lang`: Sets sounds language (e.g: *de* for German)
- `general.production`: Label to hint self-check scripts about installation mode.
- `general.maintenance`: maintenance mode necessary for safe upgrades.
- `general.timezone`: Sipwise C5 Timezone

B.1.12 ha

The following is the High Availability (ha) section:

```
ha:
  gcs: heartbeat-2
  crm: heartbeat-2
  pingnodes:
    - 10.60.1.1
    - 192.168.3.4
  pingnodes_add_gw: yes
  pingnodes_add_dns: yes
  monitor_services: none
```

- `ha.crs`: Group Communication System (GCS). Either *heartbeat-2* or *corosync*.
- `ha.crm`: Cluster Resource Manager (CRM). Either *heartbeat-2* or *pacemaker*.
- `ha.pingnodes`: List of HA pingnodes. Minimum 2 entries, otherwise by default Sipwise C5 will set the default gateway and DNS servers as pingnodes.
- `ha.pingnodes_add_gw`: Enable whether to add the gateway IP to the HA ping nodes list (only if less than 3 ping nodes are defined in the list already).
- `ha.pingnodes_add_dns`: Enable whether to add the DNS IPs to the HA ping nodes list (only if less than 3 ping nodes are defined in the list already).
- `ha.monitor_services`: Whether the HA system should periodically monitor the active services and take that into account as part of considering whether the node can act as the active one (only supported with *pacemaker*).

B.1.13 haproxy

The following is the haproxy section:

```
haproxy:
  admin: no
  admin_port: 8080
  admin_pwd: iKNPFuPFHMCHh9dsXgVg
  enable: no
```

- haproxy.enable: enable haproxy

B.1.14 heartbeat

The following is the heartbeat section:

```
heartbeat:
  hb_watchdog:
    action_max: 5
    enable: yes
    interval: 10
    transition_max: 10
```

- heartbeat.hb_watchdog.enable: Enable heartbeat watchdog in order to prevent and fix split brain scenario.
- heartbeat.hb_watchdog.action_max: Max errors before taking any action.
- heartbeat.hb_watchdog.interval: Interval in secs for the check.
- heartbeat.hb_watchdog.transition_max: Max checks in transition state.

B.1.15 intercept

The following is the legal intercept section:

```
intercept:
  enable: no
```

- intercept.enable: Enable ngcp-voisniff for Lawful Interception (additional Sipwise C5 module).

B.1.16 kamailio

The following is the kamailio section:

```
kamailio:
  lb:
    cfgt: no
    debug:
      enable: no
      modules:
        - level: '1'
          name: core
        - level: '3'
          name: xlog
    debug_level: '1'
    debug_uri:
      enable: no
      redis_db: 27
      htable_idx_size: 4
    dns:
      dns_sctp_pref: 1
      dns_tcp_pref: 1
      dns_tls_pref: 1
      dns_try_naptr: no
      dns_udp_pref: 1
      use_dns_cache: on
    external_sbc: []
    extra_sockets: ~
    max_forwards: '70'
    mem_log: '1'
    mem_summary: '12'
    max_inv_lifetime: '180000'
    natest_exception_ips:
      - 1.2.3.4
      - 5.6.7.8
    pkg_mem: '16'
    port: '5060'
    remove_isup_body_from_replies: no
    sdp_line_filter:
      enable: no
      remove_line_startswith: []
    security:
      dos_ban_enable: yes
      dos_ban_time: '300'
      dos_reqs_density_per_unit: '50'
      dos_sampling_time_unit: '5'
      dos_whitelisted_ips: []
      dos_whitelisted_subnets: []
      failed_auth_attempts: '3'
      failed_auth_ban_enable: yes
      failed_auth_ban_time: '3600'
```

```
topoh:
  enable: no
  mask_callid: no
  mask_ip: 127.0.0.8
topos:
  enable: no
  redis_db: 24
shm_mem: '64'
skip_contact_alias_for_ua_when_tcp:
  enable: no
  user_agent_patterns: []
start: yes
strict_routing_safe: no
syslog_options: yes
tcp_children: 1
tcp_max_connections: '2048'
tls:
  enable: no
  port: '5061'
  sslcertfile: /etc/ngcp-config/ssl/myserver.crt
  sslcertkeyfile: /etc/ngcp-config/ssl/myserver.key
udp_children: 1
proxy:
  allow_cf_to_itself: no
  allow_info_method: no
  allow_msg_method: no
  allow_peer_relay: no
  allow_refer_method: no
  always_anonymize_from_user: no
  authenticate_bye: no
  block_useragents:
    action: reject
    enable: no
    mode: blacklist
    ua_patterns: []
  cf_depth_limit: '10'
  cfgt: no
  check_prev_forwarder_as_upn: no
  children: 1
  decode_utu_header: no
  debug:
    enable: no
    modules:
      - level: '1'
        name: core
      - level: '3'
        name: xlog
  debug_level: '1'
```

```
default_expires: '3600'
default_expires_range: '30'
dlg_timeout: '43200'
early_rejects:
  block_admin:
    announce_code: '403'
    announce_reason: Blocked by Admin
  block_callee:
    announce_code: '403'
    announce_reason: Blocked by Callee
  block_caller:
    announce_code: '403'
    announce_reason: Blocked by Caller
  block_contract:
    announce_code: '403'
    announce_reason: Blocked by Contract
  block_in:
    announce_code: '403'
    announce_reason: Block in
  block_out:
    announce_code: '403'
    announce_reason: Blocked out
  block_override_pin_wrong:
    announce_code: '403'
    announce_reason: Incorrect Override PIN
  callee_busy:
    announce_code: '486'
    announce_reason: Busy Here
  callee_offline:
    announce_code: '480'
    announce_reason: Offline
  callee_tmp_unavailable:
    announce_code: '480'
    announce_reason: Temporarily Unavailable
  callee_tmp_unavailable_gp:
    announce_code: '480'
    announce_reason: Unavailable
  callee_tmp_unavailable_tm:
    announce_code: '408'
    announce_reason: Request Timeout
  callee_unknown:
    announce_code: '404'
    announce_reason: Not Found
  cf_loop:
    announce_code: '480'
    announce_reason: Unavailable
  emergency_invalid:
    announce_code: '404'
```

```
announce_reason: Emergency code not available in this region
emergency_unsupported:
  announce_code: '403'
  announce_reason: Emergency Calls Not Supported
invalid_speeddial:
  announce_code: '484'
  announce_reason: Speed-Dial slot empty
locked_in:
  announce_code: '403'
  announce_reason: Callee locked
locked_out:
  announce_code: '403'
  announce_reason: Caller locked
max_calls_in:
  announce_code: '486'
  announce_reason: Busy
max_calls_out:
  announce_code: '403'
  announce_reason: Maximum parallel calls exceeded
no_credit:
  announce_code: '402'
  announce_reason: Insufficient Credit
peering_unavailable:
  announce_code: '503'
  announce_reason: PSTN Termination Currently Unavailable
reject_vsc:
  announce_code: '403'
  announce_reason: VSC Forbidden
relaying_denied:
  announce_code: '403'
  announce_reason: Relaying Denied
unauth_caller_ip:
  announce_code: '403'
  announce_reason: Unauthorized IP detected
emergency_priorization:
  enable: no
  register_fake_200: yes
  register_fake_expires: '3600'
  reject_code: '503'
  reject_reason: Temporary Unavailable
  retry_after: '3600'
enum_suffix: e164.arpa.
expires_range: '30'
filter_100rel_from_supported: no
filter_failover_response: 408|500|503
foreign_domain_via_peer: no
fritzbox:
  enable: no
```

```
prefixes:
- 0$avp (caller_ac)
- $avp (caller_cc) $avp (caller_ac)
- \+$avp (caller_cc) $avp (caller_ac)
- 00$avp (caller_cc) $avp (caller_ac)
special_numbers:
- '112'
- '110'
- 118[0-9]{2}
ignore_auth_realm: no
ignore_subscriber_allowed_clis: no
keep_original_to: no
latency_limit_action: '100'
latency_limit_db: '500'
latency_log_level: '1'
latency_runtime_action: 1000
lnp:
  add_reply_headers:
    enable: no
    number: P-NGCP-LNP-Number
    status: P-NGCP-LNP-Status
  api:
    add_caller_cc_to_lnp_dst: no
    invalid_lnp_routing_codes:
      - ^EE00
      - ^DD00
    keepalive_interval: '3'
    lnp_request_blacklist: []
    lnp_request_whitelist: []
    port: '8991'
    reply_error_on_lnp_failure: no
    request_timeout: '1000'
    server: localhost
    tcap_field_fci: end.components.0.invoke.parameter
    tcap_field_lnp: ConnectArg.destinationRoutingAddress.0
    tcap_field_opcode: end.components.0.invoke.opCode
  enable: no
  execute_ncos_block_out_before_lnp: no
  skip_callee_lnp_lookup_from_any_peer: no
  strictly_check_ncos: no
  type: api
lookup_peer_destination_domain_for_pbx: no
loop_detection:
  enable: no
  expire: '1'
  max: '5'
max_expires: '43200'
max_gw_lcr: '128'
```

```
max_registrations_per_subscriber: '5'
mem_log: '1'
mem_summary: '12'
min_expires: '60'
nathelper:
  sipping_from: sip:pinger@sipwise.local
nathelper_dbro: no
natping_interval: '30'
natping_processes: 1
nonce_expire: '300'
pbx:
  hunt_display_fallback_format: '[H %s]'
  hunt_display_fallback_indicator: $var(cloud_pbx_hg_ext)
  hunt_display_format: '[H %s]'
  hunt_display_indicator: $var(cloud_pbx_hg_displayname)
  hunt_display_maxlength: 8
  ignore_cf_when_hunting: no
  skip_busy_hg_members:
    enable: no
    redis_key_name: totaluser
peer_probe:
  available_treshold: '1'
  enable: yes
  from_uri_domain: probe.ngcp.local
  from_uri_user: ping
  interval: '10'
  method: OPTIONS
  reply_codes: class=2;class=3;code=403;code=404;code=405
  timeout: '5'
  unavailable_treshold: '1'
perform_peer_failover_on_tm_timeout: yes
perform_peer_lcr: no
pkg_mem: '32'
port: '5062'
presence:
  enable: yes
  max_expires: '3600'
  reginfo_domain: example.org
proxy_lookup: no
push:
  apns_alert: New call
  apns_sound: incoming_call.xaf
report_mos: yes
set_ruri_to_peer_auth_realm: no
shm_mem: '125'
start: yes
store_recentcalls: no
syslog_options: yes
```



```

tcp_children: 1
tm:
  fr_inv_timer: '180000'
  fr_timer: '9000'
  max_inv_lifetime: '180000'
treat_600_as_busy: yes
use_enum: no
usrloc_dbmode: '1'
voicebox_first_caller_cli: yes
xfer_other_party_from: no

```

- `kamailio.lb.cfgt`: Enable/disable unit test config file execution tracing.
- `kamailio.lb.debug.enable`: Enable per-module debug options.
- `kamailio.lb.debug.modules`: List of modules to be traced with respective debug level.
- `kamailio.lb.debug.uri.enable`: Enable/disable sending SIP messages From/To specific subscriber to an inactive proxy node in order to debug/trace calls. Only makes sense on Sipwise C5 CARRIER appliance environment.
- `kamailio.lb.debug.uri.redis_db`: A number of internal Redis DB used by htable module to keep the subscribers values
- `kamailio.lb.debug.uri.htable_idx_size`: number to control how many slots (buckets) to create for the hash table (2^{size}). See [kamailio htable](#) docs for details.
- `kamailio.lb.debug.level`: Default debug level for `kamailio-lb`.
- `kamailio.lb.dns.use_dns_cache`: Enable/disable use of internal DNS cache.
- `kamailio.lb.dns.dns_udp_pref`: Set preference for each protocol when doing NAPTR lookups. In order to use remote site preferences set all `dns_*_pref` to the same positive value (e.g. `dns_udp_pref=1`, `dns_tcp_pref=1`, `dns_tls_pref=1`, `dns_sctp_pref=1`). To completely ignore NAPTR records for a specific protocol, set the corresponding protocol preference to `-1`.
- `kamailio.lb.dns.dns_tcp_pref`: See above.
- `kamailio.lb.dns.dns_tls_pref`: See above.
- `kamailio.lb.dns.dns_sctp_pref`: See above.
- `kamailio.lb.dns.dns_try_naptr`: Enable NAPTR support according to RFC 3263.
- `kamailio.lb.external_sbc`: SIP URI of external SBC used in the Via Route option of peering server.
- `kamailio.lb.extra_sockets`: Add here extra sockets for Load Balancer.
- `kamailio.lb.max_forwards`: Set the value for the Max Forwards SIP header for outgoing messages.
- `kamailio.lb.mem_log`: Specifies on which log level the memory statistics will be logged.
- `kamailio.lb.mem_summary`: Parameter to control printing of memory debugging information on exit or SIGUSR1 to log.
- `kamailio.lb.max_inv_lifetime`: Set INVITE transaction timeout per the whole transaction if no final reply for an INVITE arrives after a provisional message was received (whole transaction ringing timeout). It has to be equals or greater than `kamailio.proxy.tm.fr_inv_timer`.

- `kamailio.lb.natatest_exception_ips`: List of IPs that don't need the NAT test.
- `kamailio.lb.shm_mem`: Shared memory used by Kamailio Load Balancer.
- `kamailio.lb.pkg_mem`: PKG memory used by Kamailio Load Balancer.
- `kamailio.lb.port`: Default listen port.
- `kamailio.lb.remove_isup_body_from_replies`: Enable/disable stripping of ISUP part from the message body.
- `kamailio.lb.sdp_line_filter.enable`: Enable/Disable filter of SDP lines in all the SIP messages.
- `kamailio.lb.sdp_line_filter.remove_line_startswith`: List of the SDP lines that should be removed. Attention: it removes all SDP attribute lines beginning with the listed strings in all media streams.
- `kamailio.lb.security.dos_ban_enable`: Enable/Disable DoS Ban.
- `kamailio.lb.security.dos_ban_time`: Sets the ban time.
- `kamailio.lb.security.dos_reqs_density_per_unit`: Sets the requests density per unit (if we receive more than * `lb.dos_reqs_density_per_unit` within `dos_sampling_time_unit` the user will be banned).
- `kamailio.lb.security.dos_sampling_time_unit`: Sets the DoS unit time.
- `kamailio.lb.security.dos_whitelisted_ips`: Write here the whitelisted IPs.
- `kamailio.lb.security.dos_whitelisted_subnets`: Write here the whitelisted IP subnets.
- `kamailio.lb.security.failed_auth_attempts`: Sets how many authentication attempts allowed before ban.
- `kamailio.lb.security.failed_auth_ban_enable`: Enable/Disable authentication ban.
- `kamailio.lb.security.failed_auth_ban_time`: Sets how long a user/IP has be banned.
- `kamailio.lb.topoh.enable`: Enable topology masking module (see the [Topology Masking Mechanism](#) subchapter for a detailed description).
- `kamailio.lb.topoh.mask_callid`: if set to `yes`, the SIP Call-ID header will also be encoded.
- `kamailio.lb.topoh.mask_ip`: an IP address that will be used to create valid SIP URIs, after encoding the real/original header content.
- `kamailio.lb.topos.enable`: Enable topology hiding module (see the [Topology Hiding Mechanism](#) subchapter for a detailed description).
- `kamailio.lb.topos.redis_db`: A number of internal Redis DB used by the topology hiding module.
- `kamailio.lb.start`: Enable/disable kamailio-lb service.
- `kamailio.lb.strict_routing_safe`: Enable strict routing handle feature.
- `kamailio.lb.syslog_options`: Enable/disable logging of SIP OPTIONS messages to `kamailio-options-lb.log`.
- `kamailio.lb.tcp_children`: Number of TCP worker processes.
- `kamailio.lb.tcp_max_connections`: Maximum number of open TCP connections.

- `kamailio.lb.tls.enable`: Enable TLS socket.
- `kamailio.lb.tls.port`: Set TLS listening port.
- `kamailio.lb.tls.sslcertificate`: Path for the SSL certificate.
- `kamailio.lb.tls.sslcertkeyfile`: Path for the SSL key file.
- `kamailio.lb.udp_children`: Number of UDP worker processes.
- `kamailio.proxy.allow_cf_to_itself`: Specify whether or not a Call Forward to the same subscriber (main number to an alias or viceversa) is allowed. To stop the CF loop a source number or a b-number have to be defined in the CF configuration.
- `kamailio.proxy.allow_info_method`: Allow INFO method.
- `kamailio.proxy.allow_msg_method`: Allow MESSAGE method.
- `kamailio.proxy.allow_peer_relay`: Allow peer relay. Call coming from a peer that doesn't match a local subscriber will try to go out again, matching the peering rules.
- `kamailio.proxy.allow_refer_method`: Allow REFER method. Enable it with caution.
- `kamailio.proxy.always_anonymize_from_user`: Enable anonymization of full From URI (as opposed to just From Display-name part by default), has same effect as enabling the preference `anonymize_from_user` for all peers.
- `kamailio.proxy.authenticate_bye`: Enable BYE authentication.
- `kamailio.proxy.block_useragents.action`: one of [`drop`, `reject`] - Whether to silently drop the request from matching User-Agent or reject with a 403 message.
- `kamailio.proxy.block_useragents.enable`: Enable/disable the User-Agent blocking.
- `kamailio.proxy.block_useragents.mode`: one of [`whitelist`, `blacklist`] - Sets the mode of `ua_patterns` list evaluation (whitelist: block requests coming from all but listed User-Agents, blacklist: block requests from all listed User-Agents).
- `kamailio.proxy.block_useragents.ua_patterns`: List of User-Agent string patterns that trigger the block action.
- `kamailio.proxy.cf_depth_limit`: CF loop detector. How many CF loops are allowed before drop the call.
- `kamailio.proxy.cfgt`: Enable/disable unit test config file execution tracing.
- `kamailio.proxy.check_prev_forwarder_as_upn`: Enable/disable validation of the forwarder's number taken from the `Diversion` or `History-Info` header.
- `kamailio.proxy.children`: Number of UDP worker processes.
- `kamailio.proxy.decode_utu_header`: Default *no*. If set to *yes*, the content of the User-to-User field received in 200Ok is decoded and saved in a dedicated field of the ACC records. The decoding consists in few steps: discard everything after the first occurrence of `;`, remove the initial `04`, hex decode the remaining part.
- `kamailio.proxy.debug.enable`: Enable per-module debug options.
- `kamailio.proxy.debug.modules`: List of modules to be traced with respective debug level.
- `kamailio.proxy.debug_level`: Default debug level for `kamailio-proxy`.

- `kamailio.proxy.default_expires`: Default expires value in seconds for a new registration (for REGISTER messages that contains neither Expires HFs nor expires contact parameters).
- `kamailio.proxy.default_expires_range`: This parameter specifies that the expiry used for the registration should be randomly chosen in a range given by `default_expires +/- default_expires_range` percent. For instance, if `default_expires` is 1200 seconds and `default_expires_range` is 50, the expiry is randomly chosen between [600,1800] seconds. If set to 0, `default_expires` is left unmodified.
- `kamailio.proxy.dlg_timeout`: Dialog timeout in seconds (by default 43200 sec - 12 hours).
- `kamailio.proxy.early_rejects`: Customize here the response codes and sound prompts for various reject scenarios. See the subchapter [Configuring Early Reject Sound Sets](#) for a detailed description.
- `kamailio.proxy.emergency_prioritization.enable`: Enable an emergency mode support.
- `kamailio.proxy.emergency_prioritization.register_fake_200`: When enabled, generates a fake 200 response to REGISTER from non-prioritized subscriber in emergency mode.
- `kamailio.proxy.emergency_prioritization.register_fake_expires`: Expires value for the fake 200 response to REGISTER.
- `kamailio.proxy.emergency_prioritization.reject_code`: Reject code for the non-emergency request.
- `kamailio.proxy.emergency_prioritization.reject_reason`: Reject reason for the non-emergency request.
- `kamailio.proxy.emergency_prioritization.retry_after`: Retry-After value when rejecting the non-emergency request.

Tip

In order to learn about details of *emergency prioritization* function of NGCP please refer to Section 6.8 part of the handbook.

- `kamailio.proxy.enum_suffix`: Sets ENUM suffix - don't forget . (dot).
- `kamailio.proxy.expires_range`: Set randomization of expires for REGISTER messages (similar to `default_expires_range` but applies to received expires value).
- `kamailio.proxy.filter_100rel_from_supported`: Enable filtering of *100rel* from Supported header, to disable PRACK.
- `kamailio.proxy.filter_failover_response`: Specify the list of SIP responses that trigger a failover on the next available peering server.
- `kamailio.proxy.foreign_domain_via_peer`: Enable/disable of routing of calls to foreign SIP URI via peering servers.
- `kamailio.proxy.fritzbox.enable`: Enable detection for Fritzbox special numbers. Ex. Fritzbox add some prefix to emergency numbers.
- `kamailio.proxy.fritzbox.prefixes`: Fritybox prefixes to check. Ex. *0\$avp(caller_ac)*
- `kamailio.proxy.fritzbox.special_numbers`: Specifies Fritzbox special number patterns. They will be checked with the prefixes defined. Ex. *112*, so the performed check will be *sip:0\$avp(caller_ac)112@* if prefix is *0\$avp(caller_ac)*
- `kamailio.proxy.ignore_auth_realm`: Ignore SIP authentication realm.

- `kamailio.proxy.ignore_subscriber_allowed_clis`: Set to *yes* to ignore the subscriber's `allowed_clis` preference so that the User-Provided CLI is only checked against customer's `allowed_clis` preference.
- `kamailio.proxy.latency_limit_action`: Limit of runtime in ms for config actions. If a config action executed by `cfg` interpreter takes longer than this value, a message is printed in the logs.
- `kamailio.proxy.latency_limit_db`: Limit of runtime in ms for DB queries. If a DB operation takes longer than this value, a warning is printed in the logs.
- `kamailio.proxy.latency_log_level`: Log level to print the messages related to latency. Default is 1 (INFO).
- `kamailio.proxy.latency_runtime_action`: Limit of runtime in ms for SIP message processing cycle. If the SIP message processing takes longer than this value, a warning is printed in the logs.
- `kamailio.proxy.keep_original_to`: Not used now.
- `kamailio.proxy.lnp.add_reply_headers.enable`: Enable/disable dedicated headers to be added after LNP lookup.
- `kamailio.proxy.lnp.add_reply_headers.number`: Name of the header that will contain the LNP number.
- `kamailio.proxy.lnp.add_reply_headers.status`: Name of the header that will contain the LNP return code (200 if OK, 500/480/... if an error/timeout is occurred).
- `kamailio.proxy.lnp.api.add_caller_cc_to_lnp_dst`: Enable/disable adding of caller country code to LNP routing number of the result (*no* by default, LNP result in E.164 format is assumed).
- `kamailio.proxy.lnp.api.invalid_lnp_routing_codes` [only for `api` type]: number matching pattern for routing numbers that represent invalid call destinations; an announcement is played in that case and the call is dropped.
- `kamailio.proxy.lnp.api.keepalive_interval`: Not used now.
- `kamailio.proxy.lnp.api.lnp_request_whitelist` [only for `api` type]: list of matching patterns of called numbers for which LNP lookup must be done.
- `kamailio.proxy.lnp.api.lnp_request_blacklist` [only for `api` type]: list of matching patterns of called numbers for which LNP lookup must not be done.
- `kamailio.proxy.lnp.api.port`: Not used now.
- `kamailio.proxy.lnp.api.reply_error_on_lnp_failure`: Specifies whether platform should drop the call in case of LNP API server failure or continue routing the call to the original callee without LNP.
- `kamailio.proxy.lnp.api.request_timeout` [only for `api` type]: timeout in milliseconds while Proxy waits for the response of an LNP query from *Sipwise LNP daemon*.
- `kamailio.proxy.lnp.api.server`: Not used now.
- `kamailio.proxy.lnp.api.tcapi_field_fci`: path of the FCI INFO in the received `tcapi` message
- `kamailio.proxy.lnp.api.tcapi_field_lnp`: path of the LNP NUMBER in the received `tcapi/inapi` message
- `kamailio.proxy.lnp.api.tcapi_field_opcode`: path of the FCI OPCODE in the received `tcapi` message
- `kamailio.proxy.lnp.enable`: Enable/disable LNP (local number portability) lookup during call setup.

- `kamailio.proxy.lnp.execute_ncos_block_out_before_lnp`: if set to *yes*, the NCOS and BLOCK_OUT checks will be executed before the LNP lookup. Default is *no*, therefore the check are done after the LNP evaluation and rewriting.
- `kamailio.proxy.lnp.skip_callee_lnp_lookup_from_any_peer`: if set to *yes*, the destination LNP lookup is skipped (has same effect as enabling preference `skip_callee_lnp_lookup_from_any_peer` for all peers).
- `kamailio.proxy.lnp.strictly_check_ncos`: specify whether the NCOS LNP should be evaluated even if the LNP lookup was not previously executed or if it didn't return any occurrence. If set to *yes*, a whitelist NCOS will fail if the LNP lookup doesn't return any match. The parameter has no impact on blacklist NCOS.
- `kamailio.proxy.lnp.type`: method of LNP lookup; valid values are: `local` (local LNP database) and `api` (LNP lookup through external gateways). *PLEASE NOTE*: the `api` type of LNP lookup is only available for Sipwise C5 PRO / CARRIER installations.
- `kamailio.proxy.lookup_peer_destination_domain_for_pbx`: one of [*yes*, *no*, `peer_host_name`] - Sets the content of `destination_domain` CDR field for calls between CloudPBX subscribers. In case of *no* this field contains name of CloudPBX domain; *yes*: peer destination domain; `peer_host_name`: human-readable name of the peering server.
- `kamailio.proxy.loop_detection.enable`: Enable the SIP loop detection based on the combination of SIP-URI, To and From header URIs.
- `kamailio.proxy.loop_detection.expire`: Sampling interval in seconds for the incoming INVITE requests (by default 1 sec).
- `kamailio.proxy.loop_detection.max`: Maximum allowed number of SIP requests with the same SIP-URI, To and From header URIs within sampling interval. Requests in excess of this limit will be rejected with 482 Loop Detected response.
- `kamailio.proxy.max_expires`: Sets the maximum expires in seconds for registration. If set to *0*, the check is disabled.
- `kamailio.proxy.max_gw_lcr`: Defines the maximum number of gateways in `lcr_gw` table
- `kamailio.proxy.max_registrations_per_subscriber`: Sets the maximum registration per subscribers.
- `kamailio.proxy.mem_log`: Specifies on which log level the memory statistics will be logged.
- `kamailio.proxy.mem_summary`: Parameter to control printing of memory debugging information on exit or SIGUSR1 to log.
- `kamailio.proxy.min_expires`: Sets the minimum expires in seconds for registration. If set to *0*, the check is disabled.
- `kamailio.proxy.nathelper.sipping_from`: Set the From header in OPTIONS NAT ping.
- `kamailio.proxy.nathelper_dbro`: Default is "no". This will be "yes" on CARRIER in order to activate the use of a read-only connection using LOCAL_URL
- `kamailio.proxy.natping_interval`: Sets the NAT ping interval in seconds.
- `kamailio.proxy.natping_processes`: Set the number of NAT ping worker processes.
- `kamailio.proxy.nonce_expire`: Nonce expire time in seconds.
- `kamailio.proxy.pbx.hunt_display_fallback_format`: Default is `[H %s]`. Sets the format of the hunt group indicator that is sent as initial part of the From Display Name when subscriber is called as a member of PBX hunt group if the preferred format defined by the `hunt_display_format` and `hunt_display_indicator` can not be used (as in the case of not provisioned subscriber settings). The `%s` part is replaced with the value of the `hunt_display_fallback_indicator` variable.

- `kamailio.proxy.pbx.hunt_display_fallback_indicator`: The internal kamailio variable that sets the number or extension of the hunt group. Default is `$var (cloud_pbx_hg_ext)` which is populated during call routing with the extension of the hunt group.
- `kamailio.proxy.pbx.hunt_display_format`: Default is `[H %s]`. Sets the format of hunt group indicator that is sent as initial part of the From Display Name when subscriber is called as a member of PBX hunt group. This is the preferred (default) indicator format with Display Name, where the `%s` part is replaced with the value of the `hunt_display_indicator` variable.
- `kamailio.proxy.pbx.hunt_display_indicator`: The internal kamailio variable that contains the preferred identifier of the hunt group. Default is `$var (cloud_pbx_hg_displayname)` which is populated during call routing with the provisioned Display Name of the hunt group.
- `kamailio.proxy.pbx.hunt_display_maxlength`: Default is `8`. Sets the maximum length of the variable used as the part of hunt group indicator in Display Name. The characters beyond this limit are truncated in order for hunt group indicator and calling party information to fit on display of most phones.
- `kamailio.proxy.pbx.ignore_cf_when_hunting`: Default is `no`. Whether to disregard all individual call forwards (CFU, CFB, CFT and CFNA) of PBX extensions when they are called via hunt groups. Note that call forwards configured to local services such as Voicebox or Conference are always skipped from group hunting.
- `kamailio.proxy.pbx.skip_busy_hg_members.enable`: Default is `no`. Whether to skip the subscribers that have busy status when routing the calls to huntgroups.
- `kamailio.proxy.pbx.skip_busy_hg_members.redis_key_name`: one of [`totaluser`, `activeuser`] - Sets the internal redis key name that contains the number of active calls for the user.
- `kamailio.proxy.peer_probe.enable`: Enable the peer probing, must be also checked per individual peer in the panel/API.
- `kamailio.proxy.peer_probe.interval`: Peer probe interval in seconds.
- `kamailio.proxy.peer_probe.timeout`: Peer probe response wait timeout in seconds.
- `kamailio.proxy.peer_probe.reply_codes`: Defines the response codes that are considered successful response to the configured probe request, e.g. `class=2; class=3; code=403; code=404; code=405`, with class defining a code range.
- `kamailio.proxy.peer_probe.unavailable_treshold`: Defines after how many failed probes a peer is considered unavailable.
- `kamailio.proxy.peer_probe.available_treshold`: Defines after how many successful probes a peer is considered available.
- `kamailio.proxy.peer_probe.from_uri_user`: From-userpart for the probe requests.
- `kamailio.proxy.peer_probe.from_uri_domain`: From-hostpart for the probe requests.
- `kamailio.proxy.peer_probe.method`: [OPTIONS|INFO] - Request method for probe request.

Tip

You can find more information about peer probing configuration in Section [6.12.2](#) of the handbook.

- `kamailio.proxy.perform_peer_failover_on_tm_timeout`: Specifies the failover behavior when maximum ring timeout (`fr_inv_timer`) has been reached. In case it is set to `yes`: failover to the next peer if any; in case of `no` stop trying other peers.
- `kamailio.proxy.perform_peer_lcr`: Enable/Disable Least Cost Routing based on peering fees.

- `kamailio.proxy.pkg_mem`: PKG memory used by Kamailio Proxy.
- `kamailio.proxy.shm_mem`: Shared memory used by Kamailio Proxy.
- `kamailio.proxy.port`: SIP listening port.
- `kamailio.proxy.presence.enable`: Enable/disable presence feature
- `kamailio.proxy.presence.max_expires`: Sets the maximum expires value for PUBLISH/SUBSCRIBE message. Defines expiration of the presentity record.
- `kamailio.proxy.presence.reginfo_domain`: Set FQDN of Sipwise C5 domain used in callback for mobile push.
- `kamailio.proxy.push.apns_alert`: Set the content of *alert* field towards APNS.
- `kamailio.proxy.push.apns_sound`: Set the content of *sound* field towards APNS.
- `kamailio.proxy.report_mos`: Enable MOS reporting in the log file.
- `kamailio.proxy.set_ruri_to_peer_auth_realm`: Set R-URI using peer auth realm.
- `kamailio.proxy.start`: Enable/disable kamailio-proxy service.
- `kamailio.proxy.store_recentcalls`: Store recent calls to redis (used by Malicious Call Identification application and VSCs related to recent calls redial).
- `kamailio.proxy.syslog_options`: Enable/disable logging of SIP OPTIONS messages to `kamailio-options-proxy.log`.
- `kamailio.proxy.tcp_children`: Number of TCP worker processes.
- `kamailio.proxy.tm.fr_inv_timer`: Set INVITE transaction timeout per branch if no final reply for an INVITE arrives after a provisional message was received (branch ringing timeout).
- `kamailio.proxy.tm.fr_timer`: Set INVITE transaction timeout if the destination is not responding with provisional response message.
- `kamailio.proxy.tm.max_inv_lifetime`: Set INVITE transaction timeout per the whole transaction if no final reply for an INVITE arrives after a provisional message was received (whole transaction ringing timeout). It has to be equals or greater than `kamailio.proxy.tm.fr_inv_timer`.
- `kamailio.proxy.treat_600_as_busy`: Enable the 6xx response handling according to RFC3261. When enabled, the 6xx response should stop the serial forking. Also, CFB will be triggered or busy prompt played as in case of 486 Busy response.
- `kamailio.proxy.use_enum`: Enable/Disable ENUM feature.
- `kamailio.proxy.usrloc_dbmode`: Set the mode of database usage for persistent contact storage.
- `kamailio.proxy.voicebox_first_caller_cli`: When enabled the previous forwarder's CLI will be used as caller CLI in case of chained Call Forwards.
- `kamailio.proxy.xfer_other_party_from`: If set to *yes* transferred calls will have the number of the transferred party in the From header. Default is *no*, thus transferred calls have the number of the transferrer party in the From header.

B.1.17 ngcp-lnpd

The following section defines configuration of LNP daemon, that is used when LNP queries are served by external gateways → the so called LNP API mode.

```
lnpd:
  config:
    daemon:
      foreground: 'false'
    json-rpc:
      ports:
        - '8095'
    loglevel: '6'
    sip:
      port: '5095'
      threads: '4'
    instances:
      default:
        module: sigtran
        destination: 0.0.0.0
        from-domain: voip.example.com
        headers:
          - header: INAP-Service-Key
            value: '2'
        reply:
          tcap: raw-tcap
    enable: no
```

- `lnpd.enable`: Enable/disable LNP daemon
- `lnpd.config`: details are shown in [Configuration of LNP daemon](#)

B.1.18 ngcp-logfs

The following section configures the log obfuscation service.

```
logfs:
  cache_db: /usr/lib/ngcp-logfs/cache.db
  chmod_dirs: '0555'
  chmod_files: '0444'
  disk_retention_timeout: 365
  enable: yes
  file_cache_timeout: 2
  gid: 0
```

```
log_dir: /var/log/ngcp
max_mem_usage: 500
mem_cache_timeout: 24
mountpoint: /var/log/mirror-ngcp
suffix: \.\d+$|\-d{8}$|\-d{8}\-d+$
uid: 0
```

- logfs: details are shown in the section on [Log file obfuscation](#)

B.1.19 ngcp-mediator

The following is the ngcp-mediator section:

```
mediator:
  interval: 10
```

- mediator.interval: Running interval of *ngcp-mediator*.

B.1.20 modules

The following is the modules section:

```
modules:
  - enable: no
    name: dummy
    options: numdummies=2
```

- modules: list of configs needed for load kernel modules on boot.
- enable: Enable/disable loading of the specific module (yes/no)
- name: kernel module name
- options: kernel module options if needed

B.1.21 monitoring

The following is the check tools section:

```
monitoring:
  interval: 10
  retrospect_interval: 30
  threshold:
    cpu_idle_min: '0.1'
    disk_used_max: '0.9'
    kamailio_lb_shmem_min: '1048576'
    kamailio_proxy_shmem_min: '1048576'
    load_long_max: '2'
    load_medium_max: '2'
    load_short_max: '3'
    mem_used_max: 0.98
    mta_queue_len_max: '15'
    sip_responsiveness_max: '15'
    sslcert_timetoexpiry: '30'
    sslcert_whitelist: []
    swap_free_min: 0.02
```

- `monitoring.interval`: The number of seconds between each data gathering iteration.
- `monitoring.restrospect_interval`: The number of seconds to look into the past, when checking for the last value for a data point.
- `monitoring.threshold.cpu_idle_min`: Sets the minimum value for CPU usage (0.1 means 10%).
- `monitoring.threshold.disk_used_max`: Sets the maximum value for DISK usage (0.9 means 90%).
- `monitoring.threshold.kamailio_lb_shmem_min`: Sets the minimum value for Kamailio lb share memory usage.
- `monitoring.threshold.kamailio_proxy_shmem_min`: Sets the minimum value for Kamailio proxy share memory usage.
- `monitoring.threshold.load_long_max/load_long_max/load_short_max`: Max values for load (long, short, medium term).
- `monitoring.threshold.mem_used_max`: Sets the maximum value for memory usage (0.7 means 70%).
- `monitoring.threshold.mta_queue_len_max`: Sets the maximum value for the MTA queue length.
- `monitoring.threshold.sip_responsiveness_max`: Sets the maximum SIP responsiveness time timeout for the SIP options.
- `monitoring.threshold.sslcert_timetoexpiry`: Sets the number of days before a SSL certificate expiry starts to warn.
- `monitoring.threshold.sslcert_whitelist`: Sets a list of SSL certificate fingerprints to whitelist from the expiry check.
- `monitoring.threshold.swap_free_min`: Sets the minimum value for free swap (0.5 means 50%).

B.1.22 nginx

The following is the nginx section:

```
nginx:
  status_port: 8081
  xcap_port: 1080
```

- `nginx.status_port`: Status port used by nginx server
- `nginx.xcap_port`: XCAP port used by nginx server

B.1.23 ntp

The following is the ntp server section:

```
ntp:
  servers:
    - 0.debian.pool.ntp.org
    - 1.debian.pool.ntp.org
    - 2.debian.pool.ntp.org
    - 3.debian.pool.ntp.org
```

- `ntp.servers`: Define your NTP server list.

B.1.24 ossbss

The following is the ossbss section:

```
ossbss:
  apache:
    port: 2443
    proxylisten: 1080
  restapi:
    sslcertfile: '/etc/ngcp-panel/api_ssl/api_ca.crt'
    sslcertkeyfile: '/etc/ngcp-panel/api_ssl/api_ca.key'
  serveradmin: support@sipwise.com
  servername: "\"myserver\""
  ssl_enable: yes
  sslcertfile: '/etc/ngcp-config/ssl/myserver.crt'
  sslcertkeyfile: '/etc/ngcp-config/ssl/myserver.key'
  frontend: no
  htpasswd:
    -
    pass: '{SHA}w4zj3mxbmynIQ1jsUEjSkN2z2pk='
    user: ngcpsoap
```

```
logging:
  apache:
    acc:
      facility: daemon
      identity: oss
      level: info
    err:
      facility: local7
      level: info
  ossbss:
    facility: local0
    identity: provisioning
    level: DEBUG
  web:
    facility: local0
    level: DEBUG
provisioning:
  allow_ip_as_domain: 1
  allow_numeric_usernames: 0
  auto_allow_cli: 1
  carrier:
    account_distribution_function: roundrobin
    prov_distribution_function: roundrobin
  credit_warnings:
    -
      domain: example.com
      recipients:
        - nobody@example.com
      threshold: 1000
  faxpw_min_char: 0
  log_passwords: 0
  no_logline_truncate: 0
  pw_min_char: 6
  routing:
    ac_regex: '[1-9]\d{0,4}'
    cc_regex: '[1-9]\d{0,3}'
    sn_regex: '[1-9]\d+'
  tmpdir: '/tmp'
```

- `ossbss.frontend`: Enable/disable SOAP interface. Set value to `fcgi` to enable old SOAP interface.
- `ossbss.htpasswd`: Sets the username and SHA hashed password for SOAP access. You can generate the password using the following command: `htpasswd -nbs myuser mypassword`.
- `ossbss.provisioning.allow_ip_as_domain`: Allow or not allow IP address as SIP domain (0 is not allowed).
- `ossbss.provisioning.allow_numeric_usernames`: Allow or not allow numeric SIP username (0 is not allowed).
- `ossbss.provisioning.faxpw_min_char`: Minimum number of characters for fax passwords.

- `ossbss.provisioning.pw_min_char`: Minimum number of characters for sip passwords.
- `ossbss.provisioning.log_password`: Enable logging of passwords.
- `ossbss.provisioning.routing`: Regexp for allowed AC (Area Code), CC (Country Code) and SN (Subscriber Number).

B.1.25 pbx (only with additional cloud PBX module installed)

The following is the PBX section:

```
pbx:
  bindport: 5085
  enable: no
  highport: 55000
  lowport: 50001
  media_processor_threads: 10
  session_processor_threads: 10
  xmlrpcport: 8095
```

- `pbx.enable`: Enable Cloud PBX module.

B.1.26 prosody

The following is the prosody section:

```
prosody:
  ctrl_port: 5582
  log_level: info
```

- `prosody.ctrl_port`: XMPP server control port.
- `prosody.log_level`: Prosody loglevel.

B.1.27 pushd

The following is the pushd section:

```
pushd:
  apns:
    enable: yes
    endpoint: api.push.apple.com
```

```
endpoint_port: 0
extra_instances:
- certificate: '/etc/ngcp-config/ssl/PushCallkitCert.pem'
  enable: yes
  key: '/etc/ngcp-config/ssl/PushCallkitKey.pem'
  type: callkit
http2_jwt:
  ec_key: '/etc/ngcp-config/ssl/AuthKey_ABCDE12345.pem'
  ec_key_id: 'ABCDE12345'
  enable: yes
  issuer: 'VWXYZ67890'
  tls_certificate: ''
  tls_key: ''
  topic: 'com.example.appID'
legacy:
  certificate: '/etc/ngcp-config/ssl/PushChatCert.pem'
  feedback_endpoint: feedback.push.apple.com
  feedback_interval: '3600'
  key: '/etc/ngcp-config/ssl/PushChatKey.pem'
socket_timeout: 0
domains:
- apns:
  endpoint: api.push.apple.com
  extra_instances:
  - certificate: '/etc/ngcp-config/ssl/PushCallkitCert-example.com.pem'
    enable: no
    key: '/etc/ngcp-config/ssl/PushCallkitKey-example.com.pem'
    type: callkit
  http2_jwt:
    ec_key: '/etc/ngcp-config/ssl/AuthKey_54321EDCBA.pem'
    ec_key_id: '54321EDCBA'
    issuer: '09876ZYXWV'
    tls_certificate: ''
    tls_key: ''
    topic: 'com.example.otherAppID'
  legacy:
    certificate: '/etc/ngcp-config/ssl/PushChatCert-example.com.pem'
    feedback_endpoint: feedback.push.apple.com
    key: '/etc/ngcp-config/ssl/PushChatKey-example.com.pem'
  domain: example.com
  enable: yes
  android:
    key: 'google_api_key_for_example.com_here'
  enable: yes
  android:
    enable: yes
    key: 'google_api_key_here'
  priority:
```

```

    call: high
    groupchat: normal
    invite: normal
    message: normal
muc:
  exclude: []
  force_persistent: 'true'
  owner_on_join: 'true'
one_device_per_subscriber: no
port: 45060
processes: 4
ssl: yes
sslcertfile: /etc/ngcp-config/ssl/CAsigned.crt
sslcertkeyfile: /etc/ngcp-config/ssl/CAsigned.key
unique_device_ids: no

```

- `pushd.enable`: Enable/Disable the Push Notification feature.
- `pushd.apns.enable`: Enable/Disable Apple push notification.
- `pushd.apns.endpoint`: API endpoint hostname or address. Should be one of *api.push.apple.com* or *api.development.push.apple.com* for the newer HTTP2/JWT based protocol, or one of *gateway.push.apple.com* or *gateway.sandbox.push.apple.com* for the legacy protocol.
- `pushd.apns.endpoint_port`: API endpoint port. Normally 443 or alternatively 2197 for the newer HTTP2/JWT based protocol, or 2195 for the legacy protocol.
- `pushd.apns.legacy`: Contains all options specific to the legacy APNS protocol. Ignored when HTTP2/JWT is in use.
- `pushd.apns.legacy.certificate`: Specify the Apple certificate for push notification https requests from Sipwise C5 to an endpoint.
- `pushd.apns.legacy.key`: Specify the Apple key for push notification https requests from Sipwise C5 to an endpoint.
- `pushd.apns.legacy.feedback_endpoint`: Hostname or address of the APNS feedback service. Normally one of *feedback.push.apple.com* or *feedback.sandbox.push.apple.com*.
- `pushd.apns.legacy.feedback_interval`: How often to poll the feedback service, in seconds.
- `pushd.apns.extra_instances`: If the iOS app supports Callkit push notifications, they can be enabled here and the required separate certificate and key can be specified. Ignored if HTTP2/JWT is enabled.
- `pushd.http2_jwt`: Contains all options specific to the newer HTTP2/JWT based APNS API protocol.
- `pushd.http2_jwt.ec_key`: Name of file that contains the elliptic-curve (EC) cryptographic key provided by Apple, in PEM format.
- `pushd.http2_jwt.ec_key_id`: 10-digit identification string of the EC key in use.
- `pushd.http2_jwt.enable`: Master switch for the HTTP2/JWT based protocol. Disables the legacy protocol when enabled.
- `pushd.http2_jwt.issuer`: Issuer string for the JWT token. Normally the 10-digit team ID string for which the EC key was issued.
- `pushd.http2_jwt.tls_certificate`: Optional client certificate to use for the TLS connection.

- `pushd.http2_jwt.tls_key`: Optional private key for the client certificate to use for the TLS connection.
- `pushd.http2_jwt.topic`: Topic string for the JWT token. Normally the bundle ID for the iOS app.
- `pushd.android.enable`: Enable/Disable Google push notification.
- `pushd.android.key`: Specify the Google key for push notification https requests from Sipwise C5 to an endpoint.
- `pushd.domains`: Supports a separate set of push configurations (API keys, certificates, etc) for all subscribers of the given domain.
- `pushd.muc.exclude`: list of MUC room jids excluded from sending push notifications.
- `pushd.muc.force_persistent`: Enable/Disable MUC rooms to be persistent. Needed for Sipwise C5 app to work with other clients.
- `pushd.muc.owner_on_join`: Enable/Disable all MUC participants to be owners of the MUC room. Needed for Sipwise C5 app to work with other clients.
- `pushd.ssl`: The security protocol Sipwise C5 uses for https requests from the app in the push notification process.
- `pushd.sslcertfile`: The trusted certificate file purchased from a CA
- `pushd.sslcertkeyfile`: The key file that purchased from a CA
- `pushd.unique_device_ids`: Allows a subscriber to register the app and have the push notification enabled on more than one mobile device.

B.1.28 qos

The QoS section allows configuring the ToS (Type of Service) feature:

```
qos:  
  tos_rtp: 184  
  tos_sip: 184
```

- `qos.tos_rtp`: a ToS value for RTP traffic.
- `qos.tos_sip`: a ToS value for SIP traffic.

Tip

The ToS byte includes both DSCP and ECN bits. So, specify the DSCP value multiplied by four ($46 \times 4 = 184$) and, optionally, add the required ECN value to it (1, 2 or 3).

Set the `rtpproxy.control_tos` parameter higher than zero to enable ToS.

B.1.29 ngcp-rate-o-mat

The following is the *ngcp-rate-o-mat* section:

```
rateomat:  
  enable: yes  
  loopinterval: 10  
  splitpeakparts: 0
```

- `rateomat.enable`: Enable/Disable *ngcp-rate-o-mat*
- `rateomat.loopinterval`: How long we shall sleep before looking for unrated CDRs again.
- `rateomat.splitpeakparts`: Whether we should split CDRs on peakttime borders.

B.1.30 redis

The following is the *redis* section:

```
redis:  
  database_amount: 16  
  port: 6379  
  syslog_ident: redis
```

- `redis.database_amount`: Set the number of databases in *redis*. The default database is DB 0.
- `redis.port`: Accept connections on the specified port, default is 6379
- `redis.syslog_ident`: Specify the syslog identity.

B.1.31 reminder

The following is the *reminder* section:

```
reminder:  
  retries: 2  
  retry_time: 60  
  sip_fromdomain: voicebox.sipwise.local  
  sip_fromuser: reminder  
  wait_time: 30  
  weekdays: '2, 3, 4, 5, 6, 7'
```

- `reminder.retries`: How many times the reminder feature have to try to call you.
- `reminder.retry_time`: Seconds between retries.
- `reminder.wait_time`: Seconds to wait for an answer.

B.1.32 rsyslog

The following is the rsyslog section:

```
rsyslog:
  external_address:
  external_log: 0
  external_loglevel: warning
  external_port: 514
  external_proto: udp
  ngcp_logs_preserve_days: 93
```

- `rsyslog.external_address`: Set the remote rsyslog server.
- `rsyslog.ngcp_logs_preserve_days`: Specify how many days to preserve old rotated log files in `/var/log/ngcp/old` path.

B.1.33 rtpproxy

The following is the rtp proxy section:

```
rtpproxy:
  allow_userspace_only: yes
  cdr_logging_facility: ''
  control_tos: 0
  delete_delay: 30
  dtls_passive: no
  enable: yes
  final_timeout: 0
  firewall_iptables_chain: ''
  graphite:
    interval: 600
    prefix: rtpengine.
    server: ''
  log_level: '6'
  maxport: '40000'
  minport: '30000'
  num_threads: 0
  prefer_bind_on_internal: no
```

```
recording:
  enable: no
  mp3_bitrate: '48000'
  log_level: '6'
  nfs_host: 192.168.1.1
  nfs_remote_path: /var/recordings
  output_dir: /var/lib/rtpengine-recording
  output_format: wav
  output_mixed: yes
  output_single: yes
  resample: no
  resample_to: '16000'
  spool_dir: /var/spool/rtpengine
  rtcp_logging_facility: ''
  rtp_timeout: '60'
  rtp_timeout_onhold: '3600'
```

- `rtpproxy.allow_userspace_only`: Enable/Disable the user space failover for rtpengine (yes means enable). By default rtpengine works in kernel space.
- `rtpproxy.cdr_logging_facility`: If set, rtpengine will produce a CDR-like syslog line after each call finishes. Must be set to a valid syslog facility string (such as *daemon* or *local0*).
- `rtpproxy.control_tos`: If higher than 0, the control messages port uses the configured ToS (Type of Service) bits. See the QoS section below for details.
- `rtpproxy.delete_delay`: After a call finishes, rtpengine will wait this many seconds before cleaning up resources. Useful for possible late branched calls.
- `rtpproxy.dtls_passive`: If enabled, rtpengine will always advertise itself as a passive role in DTLS setup. Useful in WebRTC scenarios if used behind NAT.
- `rtpproxy.final_timeout`: If set, any calls lasting longer than this many seconds will be terminated, no matter the circumstances.
- `rtpproxy.firewall_iptables_chain`: If set, rtpengine will create an iptables rule for each individual media port opened in this chain.
- `rtpproxy.graphite.interval`: Interval in seconds between sending updates to the Graphite server.
- `rtpproxy.graphite.prefix`: Graphite keys will be prefixed with this string. Must include a separator character (such as a trailing dot) if one should be used.
- `rtpproxy.graphite.server`: Graphite server to send periodic statistics updates to. Disabled if set to an empty string. Must be in format *IP:port* or *hostname:port*.
- `rtpproxy.log_level`: Verbosity of log messages. The default 6 logs everything except debug messages. Increase to 7 to log everything, or decrease to make logging more quiet.
- `rtpproxy.maxport`: Maximum port used by rtpengine for RTP traffic.
- `rtpproxy.minport`: Minimum port used by rtpengine for RTP traffic.

- `rtpproxy.num_threads`: Number of worker threads to use. If set to 0, the number of CPU cores will be used.
- `rtpproxy.recording.enable`: Enable support for call recording.
- `rtpproxy.recording.mp3_bitrate`: If saving audio as MP3, bitrate of the output file.
- `rtpproxy.recording.log_level`: Same as `log_level` above, but for the recording daemon.
- `rtpproxy.recording.nfs_host`: Mount an NFS share from this host for storage.
- `rtpproxy.recording.nfs_remote_path`: Remote path of the NFS share to mount.
- `rtpproxy.recording.output_dir`: Local mount point for the NFS share.
- `rtpproxy.recording.output_format`: Either `wav` for PCM output or `mp3`.
- `rtpproxy.recording.output_mixed`: Create output audio files with all contributing audio streams mixed together.
- `rtpproxy.recording.output_single`: Create separate audio files for each contributing audio stream.
- `rtpproxy.recording.resample`: Resample all audio to a fixed bitrate (*yes* or *no*).
- `rtpproxy.recording.resample_to`: If resampling is enabled, resample to this sample rate.
- `rtpproxy.recording.spool_dir`: Local directory for temporary metadata file storage.
- `rtpproxy.rtcp_logging_facility`: If set, `rtpproxy` will write the contents of all received RTCP packets to syslog. Must be set to a valid syslog facility string (such as `daemon` or `local0`).
- `rtpproxy.rtp_timeout`: Consider a call dead if no RTP is received for this long (60 seconds).
- `rtpproxy.rtp_timeout_onhold`: Maximum limit in seconds for an onhold (1h).

B.1.34 security

The following is the security section. Usage of the firewall subsection is described in [Section 16.2](#):

```
security:
  firewall:
    enable: no
    logging:
      days_kept: '7'
      enable: yes
      file: /var/log/firewall.log
      tag: NGCPFW
  nat_rules4: ~
  nat_rules6: ~
  policies:
    forward: DROP
    input: DROP
    output: ACCEPT
```

```
rules4: ~
rules6: ~
```

- `security.firewall.enable`: Enable/disable iptables configuration and rule generation for IPv4 and IPv6 (default: `no`)
- `security.firewall.logging.days_kept`: Number of days logfiles are kept on the system before being deleted (log files are rotated daily, default: `7`)
- `security.firewall.logging.enable`: Enables/disables logging of all packets dropped by Sipwise C5 firewall (default: `yes`)
- `security.firewall.logging.file`: File firewall log messages go to (default: `/var/log/firewall.log`)
- `security.firewall.logging.tag`: String prepended to all log messages (internally `DROP` is added to any tag indicating the action triggering the message, default: `NGCPFW`)
- `security.firewall.nat_rules4`: Optional list of IPv4 firewall rules added to table `nat` using iptables-persistent syntax (default: `undef`)
- `security.firewall.nat_rules6`: Optional list of IPv6 firewall rules added to table `nat` using iptables-persistent syntax (default: `undef`)
- `security.firewall.policies.forward`: Default policy for iptables `FORWARD` chain (default: `DROP`)
- `security.firewall.policies.input`: Default policy for iptables `INPUT` chain (default: `DROP`)
- `security.firewall.policies.output`: Default policy for iptables `OUTPUT` chain (default: `ACCEPT`)
- `security.firewall.rules4`: Optional list of IPv4 firewall rules added to table `filter` using iptables-persistent syntax (default: `undef`)
- `security.firewall.rules6`: Optional list of IPv6 firewall rules added to table `filter` using iptables-persistent syntax (default: `undef`)

B.1.35 `sems`

The following is the SEMS section:

```
sems:
  bindport: 5080
  conference:
    enable: yes
    max_participants: 10
  debug: no
  highport: 50000
  lowport: 40001
  media_processor_threads: 10
  prepaid:
    enable: yes
```

```
sbc:
  calltimer_enable: yes
  calltimer_max: 3600
  outbound_timeout: 6000
  profile:
  - custom_header: []
    name: ngcp
  - custom_header: []
    name: ngcp_cf
  sdp_filter:
    codecs: PCMA,PCMU,telephone-event
    enable: yes
    mode: whitelist
  session_timer:
    enable: yes
    max_timer: 7200
    min_timer: 90
    session_expires: 300
  session_processor_threads: 10
vsc:
  block_override_code: 80
  cfb_code: 90
  cfna_code: 93
  cft_code: 92
  cfu_code: 72
  clir_code: 31
  directed_pickup_code: 99
  enable: yes
  park_code: 97
  reminder_code: 55
  speedial_code: 50
  unpark_code: 98
  voicemail_number: 2000
xmlrpcport: 8090
```

- `sems.conference.enable`: Enable/Disable conference feature.
- `sems.conference.max_participants`: Sets the number of concurrent participant.
- `sems.highport`: Maximum ports used by sems for RTP traffic.
- `sems.debug`: Enable/Disable debug mode.
- `sems.lowport`: Minimum ports used by sems for RTP traffic.
- `sems.prepaid.enable`: Enable/Disable prepaid feature.
- `sems.sbc.calltimer_max`: Set the default maximum call duration. Note that this value can be overwritten in subscriber/customer/domain preferences setting `max_call_duration` parameter. Attention: in case of call transfer done by the callee, with `max_call_duration` set, the timer will be restarted from 0 for the new transferred call.

- `sems.sbc.outbound_timeout`: Set INVITE transaction timeout if the destination is not responding with provisional response message.
- `sems.sbc.profile.name`: Profile's name where to add the custom headers in `header_list` config parameter. Supported values: `ngcp` and `ngcp_cf`.
- `sems.sbc.profile.custom_header`: List of the custom headers that has to be whitelisted (default) by `sems sbc` in the corresponding profile.
- `sems.sbc.session_timer.enable`: If set to "no" all session timer headers are stripped off without considering the session timer related configuration done via the web interface. If set to "yes" the system uses the subscriber/peer configurations values set on the web interface. If set to "transparent" no validation is performed on Session Timer headers, they are ignored by SEMS and therefore negotiated end-to-end.
- `sems.vsc.*`: Define here the VSC codes.

B.1.36 sms

This section provides configuration of **Short Message Service** on the NGCP. Description of the SMS module is provided earlier in this handbook [here](#).

In the below example you can see the default values of the configuration parameters.

```
sms:
  core:
    admin_port: '13000'
    smsbox_port: '13001'
  enable: no
  loglevel: '0'
  sendsms:
    max_parts_per_message: '5'
    port: '13002'
  smsc:
    dest_addr_npi: '1'
    dest_addr_ton: '1'
    enquire_link_interval: '58'
    host: 1.2.3.4
    id: default_smsc
    max_pending_submits: '10'
    no_dlr: yes
    password: password
    port: '2775'
    source_addr_npi: '1'
    source_addr_ton: '1'
    system_type: ''
    throughput: '5'
    transceiver_mode: '1'
```



```
username: username
```

- sms.core.admin_port: Port number of admin interface of SMS core module (running on LB nodes).
- sms.core.smsbox_port: Port number used for internal communication between *bearerbox* module on LB nodes and *smsbox* module on PRX nodes. This is a listening port of the *bearerbox* module (running on LB nodes).
- sms.enable: Set to `yes` if you want to enable SMS module.
- sms.loglevel: Log level of SMS module; the default `0` will result in writing only the most important information into the log file.
- sms.sendsms.max_parts_per_message: If the SM needs to be sent as concatenated SM, this parameter sets the max. number of parts for a single (logical) message.
- sms.sendsms.port: Port number of *smsbox* module (running on PRX nodes).
- sms.smsc. : Parameters of the connection to an SMSC
 - dest_addr_npi: Telephony numbering plan indicator for the SM destination, as defined by standards (e.g. `1` stands for E.164)
 - dest_addr_ton: Type of number for the SM destination, as defined by standards (e.g. `1` stands for "international" format)
 - enquire_link_interval: Interval of SMSC link status check in seconds
 - host: IP address of the SMSC
 - id: An arbitrary string for identification of the SMSC; may be used in log files and for routing SMS.
 - max_pending_submits: The maximum number of outstanding (i.e. not acknowledged) SMPP operations between Sipwise C5 and SMSC. As a guideline it is recommended that no more than 10 (default) SMPP messages are outstanding at any time.
 - no_dlr: Do not request delivery report; when sending an SM and this parameter is set to `yes`, Sipwise C5 will not request DR for the message(s). May be required for some particular SMSCs, in order to avoid "Incorrect status report request parameter usage" error messages from the SMSC.
 - password: This is the password used for authentication on the SMSC.
 - port: Port number of the SMSC where Sipwise C5 will connect to.
 - source_addr_npi: Telephony numbering plan indicator for the SM source, as defined by standards (e.g. `1` stands for E.164)
 - source_addr_ton: Type of number for the SM source, as defined by standards (e.g. `1` stands for "international" format)
 - system_type: Defines the SMSC client category in which Sipwise C5 belongs to; defaults to "VMA" (Voice Mail Alert) when no value is given. (No need to set any value)
 - throughput: The max. number of messages per second that Sipwise C5 will send towards the SMSC. (Value type: float)
 - transceiver_mode: If set to `1` (yes / true), Sipwise C5 will attempt to use a TRANSCEIVER mode connection to the SMSC. It uses the standard transmit port of the SMSC for receiving SMS too.
 - username: This is the username used for authentication on the SMSC.

B.1.37 snmpd

The following is the snmpd section:

```
snmpd:
  agentx_timeout: 15
  communities:
    - name: public
      sources:
        - localhost
  trap_communities:
    - name: public
      targets:
        - localhost
  traps:
    if:
      link: yes
    ucd:
      disk: yes
      exec: yes
      load: yes
      process: yes
      swap: yes
```

- `snmpd.agentx_timeout`: Sets the Agent X connection timeout, when communicating with a sub-agent (such as `ngcp-snmp-agent`).
- `snmpd.communities.*`: Sets the SNMP community and sources. Entries (i.e. the `sources`) for a community (like `public` in the example) are in a list of hashes format, each line starting with "-" and followed by the name and a list of source addresses.
- `snmpd.trap_communities.*`: Sets the SNMP TRAP community and destination for traps sent by NGCP. Format is the same as for `snmpd.communities`, but instead of `sources` it uses `targets`.
- `snmpd.traps.if.*`: Enables/disables the emission of SNMP IF MIB traps.
- `snmpd.traps.ucd.*`: Enables/disables the emission of SNMP UCD MIB traps.

B.1.38 snmptrapd

The following is the snmptrapd section:

```
snmptrapd:
  enable: no
```

- `snmptrapd.enable`: Enable the snmptrap daemon.

B.1.39 snmpagent

The following is the SNMP Agent section:

```
snmpagent:
  debug: no
  retrospect_interval: 30
  traps:
    collective_check: yes
    database: yes
    ha_switchover: yes
    peering: yes
    process: yes
  traps_origin: mgmt
  update_interval: '30'
```

- `debug`: Enables/disables debug output.
- `retrospect_interval`: Sets the interval the agent will use when looking into past fetched data.
- `traps.*`: Enables/disables emission of SNMP SIPWISE MIB traps.
- `traps_origin`: Sets the trap emission origin mode. The values can be one of *legacy*, *mgmt* or *distributed*.
- `update_interval`: Sets the interval in seconds used to update the fetched data.

B.1.40 sshd

The following is the sshd section:

```
sshd:
  listen_addresses:
    - 0.0.0.0
```

- `sshd`: specify interface where SSHD should run on. By default sshd listens on all IPs found in `network.yml` with type `ssh_ext`. Unfortunately sshd can be limited to IPs only and not to interfaces. The current option makes it possible to specify allowed IPs (or all IPs with 0.0.0.0).

B.1.41 sudo

The following is in the sudo section:

```
sudo:
  logging: no
  max_log_sessions: 0
```

- `logging`: enable/disable the I/O logging feature of sudo. See man page of `sudoreplay(8)`.
- `max_log_sessions`: when I/O logging is enabled, specifies how many log sessions per individual user sudo should keep before it starts overwriting old ones. The default `0` means no limit.

B.1.42 telegraf

The following is in the telegraf section:

```
telegraf:
  interval: ~
```

- `telegraf.interval`: The number of seconds between each data gathering iteration, when the value is undefined, the code will fallback to use `monitoring.interval`.

B.1.43 voisniff

The following is the voice sniffer section:

```
voisniff:
  admin_panel: yes
  daemon:
    custom_bpf: ''
  filter:
    exclude:
      - active: '0'
        case_insensitive: '1'
        pattern: '\ncseq: *\d+ +(register|notify|options)'
```

```
    include: []
  sip_ports:
    - 5060
    - 5062
  interfaces:
    extra: []
    types:
      - sip_int
      - sip_ext
```

```

- rtp_ext
li_x1x2x3:
  call_id:
    del_patterns:
      - _pbx\-1(?:_[0-9]{1,10})?$
      - _b2b\-1(?:_[0-9]{1,10})?$
      - _xfer\-1(?:_[0-9]{1,10})?$
  captagent:
    cin_max: '3000'
    cin_min: '0'
    x2:
      threads: 20
  client_certificate: ''
  enable: no
  fix_checksums: no
  fragmented: no
  interface:
    excludes: []
  local_name: sipwise
  x1:
    port: '18090'
  x23:
    protocol: sipwise
mysql_dump:
  enable: yes
  max_query_len: 67108864
  num_threads: '4'
rtp_filter: yes
start: yes
threads_per_interface: '2'
partitions:
  increment: '700000'
  keep: '10'

```

Parameters commonly used for call statistics retrievable on the web interface and for lawful interception:

- `voisniff.daemon.filter.exclude` and `voisniff.daemon.filter.include`: Additional filter to determine packets that need to be excluded from / included in capturing.
- `voisniff.daemon.start`: Change to `yes` if you want `ngcp-voisniff` start at boot. Default is `no`.
- `voisniff.daemon.threads_per_interface`: Controls how many threads per enabled sniffing interface should be launched.

Parameters used only for call statistics:

- `voisniff.admin_panel`: Enable/Disable call statistics on Admin interface. Default: `no`.
- `voisniff.daemon.mysql_dump.enable`: Needs to be switched to `yes` to enable call statistics.

The parameters relevant to Lawful Interception are described in Section [18.3.2.2](#)

B.1.44 ngcp-witnessd

The following is the ngcp-witnessd tool section:

```
witnessd:
  debug: no
  interval: ~
  gather:
    asr_ner_statistics: yes
    ha_node_force: no
    ha_node_state: yes
    kamilio_concurrent_calls: yes
    kamilio_dialog_active: yes
    kamilio_dialog_early: yes
    kamilio_dialog_incoming: yes
    kamilio_dialog_local: yes
    kamilio_dialog_outgoing: yes
    kamilio_dialog_relay: yes
    kamilio_shmem: yes
    kamilio_usrloc_regdevices: yes
    kamilio_usrloc_regusers: yes
    peering_groups: yes
    mpt_status: no
    mta_queue_len: yes
    mysql_global_status: yes
    mysql_slave_status: yes
    mysql_replicate_check_interval: '3600'
    mysql_replicate_check_tables:
      - accounting
      - billing
      - carrier
      - kamilio
      - ngcp
      - provisioning
      - prosody
      - rtcengine
      - stats
    mysql_replicate_ignore_tables:
      - accounting.acc_backup
      - accounting.acc_trash
      - kamilio.acc_backup
      - kamilio.acc_trash
      - ngcp.pt_checksums_sp1
      - ngcp.pt_checksums_sp2
```

```
- ngcp.pt_checksums
oss_provisioned_subscribers: yes
sip_responsiveness: yes
sip_stats_num_packets: yes
sip_stats_num_packets_perday: yes
sip_stats_partition_size: yes
```

- `witnessd.interval`: The number of seconds between each data gathering iteration, when the value is undefined, the code will fallback to use `monitoring.interval`.
- `witnessd.gather.asr_ner_statistics`: Enable ASR/NER statistics data.
- `witnessd.gather.ha_node_force`: Enable data gathering, even if the High-Availavility node status is not active.
- `witnessd.gather.ha_node_status`: Enable High-Availabilty node status data.
- `witnessd.gather.kamailio_*`: Enable Kamailio statistics data.
- `witnessd.gather.mpt_status`: Enable MPT RAID status data.
- `witnessd.gather.mta_queue_len`: Enable MTA (exim4) queue length data.
- `witnessd.gather.mysql_global_status`: Enable global MySQL data.
- `witnessd.gather.mysql_slave_status`: Enable salave (replication) MySQL data.
- `witnessd.gather.mysql_replicate_check_interval`: MySQL replication check interval in seconds.
- `witnessd.gather.mysql_replicate_check_tables`: List of tables that need to be checked for replication issues.
- `witnessd.gather.mysql_replicate_ignore_tables`: List of tables that need to be ignored during replication check.
- `witnessd.gather.oss_provisioned_subscribers`: Enable OSS provisioned subscribers count data.
- `witnessd.gather.sip_*`: Enable SIP statistics data.

B.1.45 `www_admin`

The following is the WEB Admin interface (`www_admin`) section:

```
www_admin:
  ac_dial_prefix: 0
  apache:
    autoprov_port: 1444
  billing_features: 1
  callingcard_features: 0
  callthru_features: 0
  cc_dial_prefix: 00
  conference_features: 1
```

```
contactmail: adjust@example.org
dashboard:
  enable: 1
default_admin_settings:
  call_data: 0
  is_active: 1
  is_master: 0
  read_only: 0
  show_passwords: 1
domain:
  preference_features: 1
  rewrite_features: 1
  vsc_features: 0
fastcgi_workers: 2
fax_features: 1
fees_csv:
  element_order:
    - source
    - destination
    - direction
    - zone
    - zone_detail
    - onpeak_init_rate
    - onpeak_init_interval
    - onpeak_follow_rate
    - onpeak_follow_interval
    - offpeak_init_rate
    - offpeak_init_interval
    - offpeak_follow_rate
    - offpeak_follow_interval
    - use_free_time
http_admin:
  autoprov_port: 1444
  port: 1443
  serveradmin: support@sipwise.com
  servername: "\"myserver\""
  ssl_enable: yes
  sslcertfile: '/etc/ngcp-config/ssl/myserver.crt'
  sslcertkeyfile: '/etc/ngcp-config/ssl/myserver.key'
http_csc:
  autoprov_bootstrap_port: 1445
  autoprov_port: 1444
  port: 443
  serveradmin: support@sipwise.com
  servername: "\"myserver\""
  ssl_enable: yes
  sslcertfile: '/etc/ngcp-config/ssl/myserver.crt'
  sslcertkeyfile: '/etc/ngcp-config/ssl/myserver.key'
```



```
logging:
  apache:
    acc:
      facility: daemon
      identity: oss
      level: info
    err:
      facility: local7
      level: info
peer:
  preference_features: 1
peering_features: 1
security:
  password_allow_recovery: 0
  password_max_length: 40
  password_min_length: 6
  password_musthave_digit: 0
  password_musthave_lowercase: 1
  password_musthave_specialchar: 0
  password_musthave_uppercase: 0
  password_sip_autogenerate: 0
  password_sip_expose_subadmin: 1
  password_web_autogenerate: 0
  password_web_expose_subadmin: 1
speed_dial_vsc_presets:
  vsc:
    - '*0'
    - '*1'
    - '*2'
    - '*3'
    - '*4'
    - '*5'
    - '*6'
    - '*7'
    - '*8'
    - '*9'
subscriber:
  auto_allow_cli: 0
  extension_features: 0
voicemail_features: 1
```

- `www_admin.http_admin.*`: Define the Administration interface and certificates.
- `www_admin.http_csc.*`: Define the Customers interface and certificates.
- `www_admin.contactmail`: Email to show in the GUI's Error page.

B.2 constants.yml Overview

`/etc/ngcp-config/constants.yml` is one of the main configuration files that contains important (static) configuration parameters, like Sipwise C5 system-user data.



Caution

Sipwise C5 platform administrator should not change content of `constants.yml` file unless absolutely necessary. Please contact Sipwise Support before changing any of the parameters within the `constants.yml` file!

B.3 network.yml Overview

`/etc/ngcp-config/network.yml` is one of the main configuration files that contains network-related configuration parameters, like IP addresses and roles of the node(s) in Sipwise C5 system.

The next example shows a part of the `network.yml` configuration file. Explanation of all the configuration parameters is provided in [Network Configuration](#) section of the handbook.

Sample host configuration for Sipwise C5

A PRO would look like:

```
sp1:
  dbnode: '1'
  eth0:
    dns_nameservers:
      - 192.168.51.30
      - 192.168.51.31
    gateway: 192.168.22.1
    hwaddr: 06:1e:bc:e2:ec:fb
    ip: 10.0.2.15
    netmask: 255.255.255.0
    shared_ip: ~
    shared_v6ip: ~
    type:
      - web_ext
      - ssh_ext
      - web_int
  eth1:
    hwaddr: 6e:7f:3a:f9:db:1f
    ip: 192.168.255.251
    netmask: 255.255.255.248
    shared_ip:
      - 192.168.255.250
    shared_v6ip: ~
```

```
  type:
    - ha_int
    - ssh_ext
eth2:
  ip: 10.15.20.107
  netmask: 255.255.255.0
  shared_ip:
    - 10.15.20.151
  type:
    - ssh_ext
    - web_ext
    - web_int
    - sip_ext
    - rtp_ext
    - mon_ext
interfaces:
  - lo
  - eth0
  - eth1
  - eth2
lo:
  advertised_ip: []
  cluster_sets:
    - default
  hwaddr: 00:00:00:00:00:00
  ip: 127.0.0.1
  netmask: 255.0.0.0
  shared_ip: []
  shared_v6ip: []
  type:
    - sip_int
    - web_ext
    - web_int
    - aux_ext
    - ssh_ext
    - api_int
  v6ip: '::1'
peer: sp2
role:
  - proxy
  - lb
  - mgmt
  - rtp
  - db
status: 'online'
```

A CARRIER would look like:

```
web01a:
  bond0:
    bond_miimon: '100'
    bond_mode: active-backup
    bond_slaves: 'eth0 eth1'
    hwaddr: 00:00:00:00:00:00
    ip: 192.168.1.2
    netmask: 255.255.255.0
    shared_ip:
      - 192.168.1.1
    type:
      - boot_int
  eth0:
    hwaddr: 00:00:00:00:00:00
  eth1:
    hwaddr: 00:00:00:00:00:00
  interfaces:
    - vlan11
    - vlan666
    - vlan35
    - vlan100
    - vlan80
    - vlan90
    - vlan15
    - vlan20
    - lo
    - eth0
    - eth1
    - bond0
  lo:
    advertised_ip: []
    hwaddr: 00:00:00:00:00:00
    ip: 127.0.0.1
    netmask: 255.0.0.0
    shared_ip: []
    shared_v6ip: []
    type:
      - ssh_ext
      - api_int
    v6ip: '::1'
  peer: web01b
  role:
    - mgmt
  status: 'online'
  vlan20:
    advertised_ip: []
```

```
hwaddr: 00:00:00:00:00:00
ip: 172.31.3.75
netmask: 255.255.255.240
shared_ip:
  - 172.31.3.74
type:
  - web_int
vlan_raw_device: bond0
post_up:
  - 'route add -host 172.30.172.247 gw 172.31.3.65 dev vlan20'
vlan100:
hwaddr: 00:0a:f7:8d:32:ec
ip: 172.31.3.5
netmask: 255.255.255.224
shared_ip:
  - 172.31.3.4
type:
  - ha_int
  - web_int
  - ssh_ext
vlan_raw_device: bond0
vlan11:
dns_nameservers:
  - 172.31.3.244
  - 192.168.56.11
  - 192.168.57.11
gateway: 172.31.3.33
hwaddr: 00:00:00:00:00:00
ip: 172.31.3.37
netmask: 255.255.255.224
shared_ip:
  - 172.31.3.36
shared_v6ip: []
type:
  - mon_ext
  - ssh_ext
vlan_raw_device: bond0
vlan15:
hwaddr: 00:00:00:00:00:00
ip: 192.168.181.201
netmask: 255.255.255.0
post_up:
  - 'route add -net 172.25.240.0/24 gw 192.168.181.1 dev vlan15'
  - 'route add -net 192.168.6.0/24 gw 192.168.181.1 dev vlan15'
shared_ip:
  - 192.168.181.200
type:
  - ssh_ext
```

```
- web_int
- mon_ext
vlan_raw_device: bond0
vlan35:
  hwaddr: 00:00:00:00:00:00
  ip: 172.31.3.101
  netmask: 255.255.255.240
  shared_ip:
    - 172.31.3.100
  type:
    - sip_int
  vlan_raw_device: bond0
vlan666:
  hwaddr: 00:00:00:00:00:00
  ip: 46.5.10.37
  netmask: 255.255.255.240
  shared_ip:
    - 46.5.10.36
  type:
    - web_ext
  vlan_raw_device: bond0
vlan80:
  hwaddr: 00:00:00:00:00:00
  ip: 172.31.3.237
  netmask: 255.255.255.248
  shared_ip:
    - 172.31.3.236
  type:
    - phone_ext
    - web_ext
  vlan_raw_device: bond0
  post_up:
    - 'ip route add default via 172.31.3.233 dev vlan80 table phones_ext'
    - 'ip rule add from 172.31.3.236 lookup phones_ext prio 1000'
vlan90:
  hwaddr: 00:00:00:00:00:00
  ip: 46.5.10.53
  netmask: 255.255.255.248
  post_up:
    - 'route add -host 77.244.249.93 gw 46.5.10.49 dev vlan90'
  shared_ip:
    - 46.5.10.52
  type:
    - repos_ext
  vlan_raw_device: bond0
```

C MariaDB encryption

C.1 Overview

MariaDB encryption support (officially called as "Data-at-Rest") enables innodb files, tables and binlogs data encryption so that if copied over the data is not usable without the master key. All the data accessed or modified by clients is encrypted/decrypted on the fly and transparent for the users. The feature comes with a price of 3% to 5% MariaDB performance loss (depending on the hardware, and CPU in particular).

C.2 Configuration

There are new options in `constants.yml`

```
mysql:
  encryption:
    enable: yes
    encrypt_binlog: yes
    key: 1;a356c82422a9031f2e472047ad8220eeeea257d611849fbdc9f75b49933f75241
    threads: 1
```

NOTE: all changes in the configuration section will cause the MariaDB server to restart when `ngcpcfg` templates are applied.

- `mysql.encryption.enable`: Switch encryption on/off. Values: *yes,no*, Default: *yes*. When enabled, all tables are being encrypted, it takes from a few seconds to several minutes for MariaDB to encrypt all the data (depending on the overall size) and the encryption procedure is performed in the background, while all the data continues to be fully accessible. Also all new tables are created encrypted by default and it is not possible to disable encryption for specific tables as the encryption is *forced*.
- `mysql.encryption.encrypt_binlog`: Encrypt binlogs. Values: *yes,no*, Default: *yes*. While it is preferred to have this option enabled by default, for scenarios where binlog files need to be parsed, this option can be turned off. It is also possible to use `mysqlbinlog` with `--read-from-remote-server` option to read encrypted binlogs.
- `mysql.encryption.key`: Encryption key. The value is randomly generated during the `cfg-schema` upgrade when the option is added into `constants.yml`. The key is located in `/etc/mysql/keyfile` and normally **MUST NOT** be changed. Changing or losing the key permanently will render all the MariaDB tablespaces data (databases/tables) unusable.
- `mysql.encryption.threads`: Amount of encryption threads. Default: 1 How many MariaDB encryption threads should be running, this value depends on how many tables are created/removed or the encryption keys are rotated.

C.3 What is not encrypted

- `slow-queries` log
- `mysqld.err` log

- `general queries log`, if enabled

C.4 Data restoration remarks

- When restoring data from an sql backup from another platform it is safe to do that as the currently used *encryption_key* (inside `my.cnf`) is not affected this way.
- When copying `constants.yml` file from another platform and the encryption is enabled, the current *mysql.encryption.key* (inside `constants.yml`) must be restored in `constants.yml` to the same one the MariaDB server is originally started with or it will fail to start otherwise after `ngcpcfg apply`.

D Faxserver Configuration

For an overview of Faxserver architecture and features, please see the [Faxserver](#) chapter.

D.1 Faxserver Components

Starting from mr4.3 release there is a completely reworked fax server in a form of standalone daemon that uses Asterisk as its transmission component. No other component—such as `hylafax` or `iaxmodem`—is necessary to send and receive faxes on Sipwise C5 platform.

D.2 Enabling Faxserver

In order to configure functions of Sipwise C5 Faxserver one needs to update the main NGCP configuration file `/etc/ngcp-config/` with the correct fax options:

```
faxserver:
  enable: yes
  fail_attempts: '3'
  fail_retry_secs: '60'
  keep_failed_fax: yes
  keep_failed_fax_days: '60'
  keep_received_fax: yes
  keep_received_fax_days: '60'
  keep_sent_fax: yes
  keep_sent_fax_days: '60'
  mail_from: 'Sipwise C5 FaxServer <voipfax@ngcp.sipwise.local>'
```

Parameters are:

- `enable`: must be `yes` to enable Faxserver
- `fail_...` : the number and timeout of fax sending retrials
- `keep_...` : fax retention definitions: enabling and length in days
- `mail_from`: the *From* header in the e-mail that is sent by Fax2Mail feature when a fax is received



Important

Ensure that in `network.yml` the `api_int` interface is assigned to the appropriate network interface or on a CARRIER to a VLAN of the node with the `mgmt` role. Usually, this is the same network interface or on a CARRIER the VLAN where the `ha_int` interface is assigned to. The `api_int` interface must be removed from all other nodes.

D.3 Fax Templates Configuration

One needs to update `/etc/ngcp-config/templates/etc/ngcp-faxserver/faxserver.conf.tt2` if he wants to use custom content in the fax and e-mail templates that are used by Faxserver to generate the actual fax or e-mail. This may be done under the "User templates" section in the file.

Applying new Faxserver configuration

Once the above mentioned configuration files have been modified the new settings must be applied:

```
ngcpcfg apply 'Configured fax server'  
ngcpcfg push all
```

D.4 Fax Services Configuration per Subscriber

Fax services must be explicitly activated for subscribers before they can send or receive faxes. This activation and the custom settings may be set on Sipwise C5 Web panel in the following way (as an administrator):

- Go to *Subscribers* and find the subscriber that you want to modify settings for
- Click on *Preferences* button
- Select *FaxFeatures*

In both sections *Fax2Mail and SendFax* and *Mail2Fax* there is a field: *Active*. This must be changed from *no* to *yes* if the particular fax service must be activated.

When fax services have been activated the user sees a summary of settings in *FaxFeatures* section on his *Preferences* page:

Voicemail and Voicebox		
Fax Features		
Fax2Mail and Sendfax		
Name	Value	
Name in Fax Header for Sendfax		
Active	yes	
Destinations	subscriber1@example.org as TIFF	
Mail2Fax		
Name	Value	
Active	yes	
Secret Key (empty=disabled)		
Secret Key Renew	never	
Last Secret Key Modify Time		
Secret Key Renew Notify		
ACL	regex from_email <u>subscriber1@example.org</u> and received_from <u>any</u> to <u>^4399.+</u> destination	
Speed Dial		

Figure 180: Fax Settings

Details of Fax2Mail, SendFax and Mail2Fax settings are described in subsequent paragraphs.

D.5 Fax2Mail and SendFax Settings

- **Name in Fax Header for SendFax:** optional field that contains the subscribers name on faxes sent from the Web panel directly
- **Destinations:** e-mail addresses and selections of notification items that define about which event and where an e-mail is sent; this is a list of such definitions

Edit destinations ✕

Destination Email

File Type

Deliver Incoming Faxes

Deliver Outgoing Faxes

Receive Reports

Figure 181: Fax2Mail Destination

The parameters for a destination are as follows:

- `Destination Email`: the e-mail address where the notification must be sent
- `File Type`: file format of faxes attached to e-mails
- `Deliver Incoming Faxes`: select this in order to receive incoming faxes in e-mail
- `Deliver Outgoing Faxes`: select this in order to receive a report about sent faxes
- `Receive Reports`: select this in order to receive reports about success / failure of fax transmissions

D.6 Mail2Fax Settings

A subscriber can restrict access to his Mail2Fax service with some methods, those can also be combined:

- using a *secret key* that is only known to him, and is inserted in every mail that he sends to Sipwise C5 to be forwarded as fax
- using an *access control list (ACL)* that determines from which endpoint and for which destination a mail-to-fax is accepted by Sipwise C5 platform

- `Secret Key`: the secret key used to validate the sender of an e-mail; not used if left empty
- `Secret Key Renew`: secret key renewal period; Sipwise C5 platform will enforce renewal of the secret key when the defined time has elapsed
- `Last Secret Key Modify Time`: information about the last secret key modification time
- `Secret Key Renew Notify`: an e-mail address where the notification about secret key modification is sent
- `ACL`: access control list, see the details below; this is a list of access control rules

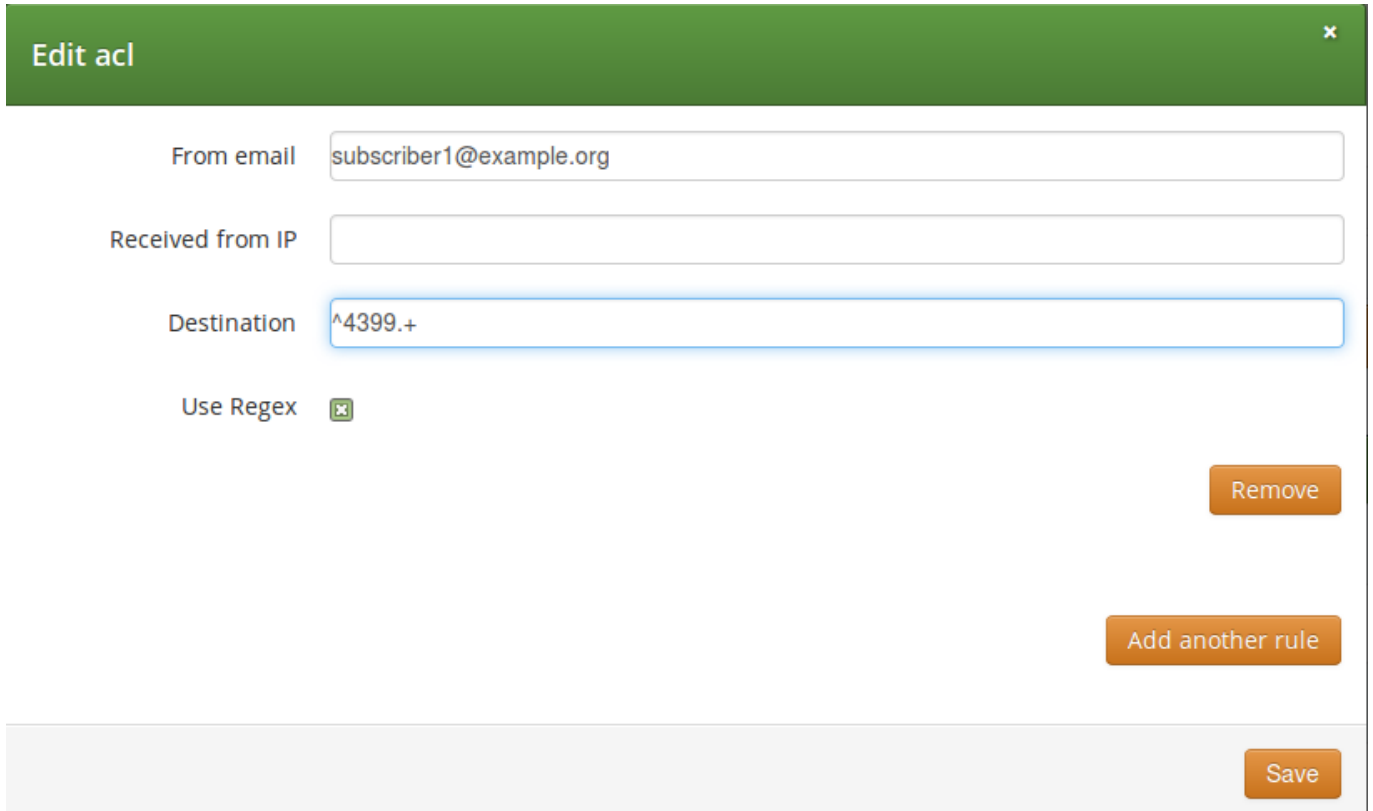

The screenshot shows a web interface for editing an Access Control List (ACL) rule. The form is titled "Edit acl" and includes the following fields and controls:

- From email**: A text input field containing the value "subscriber1@example.org".
- Received from IP**: An empty text input field.
- Destination**: A text input field containing the regular expression "^4399.+".
- Use Regex**: A checkbox that is currently checked.
- Remove**: An orange button located to the right of the "Destination" field.
- Add another rule**: An orange button located below the "Remove" button.
- Save**: An orange button located at the bottom right of the form.

Figure 182: Mail2Fax Access Control List

The parameters for access control rules:

- `From email`: this sender is allowed to use Mail2Fax service. It can be either an email address or a regular expression (if *Use Regex* checkbox is ticked). Note: Only the first `To` email header will be considered to obtain the destination subscriber.
- `Received from IP`: this IP address or host name must be present in any of the `Received` e-mail headers. It can also be a regular expression if *Use Regex* checkbox is ticked.
- `Destination`: either a complete phone number in E.164 format, or a regular expression ("Use Regex" checkbox must be ticked) that may define a range of numbers. Examples: "4313334445" as a single number; "^4399.+" as a regular expression: all destinations starting with "4399".

**Caution**

When neither *Secret Key*, nor *ACL* is defined then Mail2Fax service will deny accepting any e-mail for sending faxes!

D.7 Sending Fax from Web Panel

A subscriber can log in to his *Customer Self Care* website and send faxes directly from there. In order to do this, one needs to do the following:

- Go to *Settings* → *Web Fax* page

Tip

The list of received faxes is also available here.

- Press *Send Fax* button to start entering data, such as recipient and content for the fax being sent:

Create Fax ×

Destination Number

Quality

Page header

Content

File handbook-pro.pdf

Figure 183: Sending Fax from Web Panel

Both plain text message and attached files can be sent in the fax. First page(s) will contain the plain text message and the content of attached files will follow that.

D.8 Faxserver Mail2Fax Configuration

Using Sipwise C5 Faxserver's Mail2Fax service requires the configuration of Sipwise C5's local mail server that is *Exim*. It has to be configured in a way that it can receive mails from outside of the server, because *Exim* by default listens only on the local interfaces for incoming mails.

Exim Configuration

The Sipwise C5 platform administrator must reconfigure *Exim* in order to enable receiving e-mails for fax sending:

```
sudoedit /etc/ngcp-config/config.yml # edit section 'email:' according to your needs
sudo ngcpcfg apply 'adjust exim4 / MTA configuration'
```

PLEASE NOTE: When entering configuration data the following points must be kept in mind:

- operation mode has to be set to "mail sent by smarthost; no local mail"
- "mail2fax.example.org" must be added to accepted domains, where "example.org" is the domain name of Sipwise C5 platform operator

DNS Configuration

It is necessary to add a subdomain starting as `mail2fax.` to the list of domain names. That is where the faxes will be sent by users to trigger Mail2Fax service.

Tip

Alternatively, edit `/etc/ngcp-config/templates/etc/exim4/conf.d/router/999_mail2fax.tt2` file and adjust it to your personal preferences. Although this is not recommended and should only be done by Sipwise support engineers.

D.9 Sending Fax Using E-mail Clients

When sending an e-mail that should be converted to a fax, there are some points to keep in mind so that Faxserver properly processes the e-mail.

- **To header:**
 - must contain the subscriber's number who is sending the fax, as the username part of the mail address
 - must contain the specific domain starting with `mail2fax.`
- **Subject header:** must contain the fax destination number

- **Body** should consist of plain text data
- Adding **attachments** is possible, but only plain text and PDF formats are supported

Secret Key

In order to use the "secret key" access control feature, it should be either put in the first row of the e-mail body followed by an empty line, or included as a plain text attachment. Once it has been validated, it will be removed from the email.



Important

Either add the secret key to the body, or attach it. Never do both as only one will be recognized and removed, leaving the other one to be sent as part of the fax.

Mail Example

Provided there is a subscriber on Sipwise C5 platform with the 43130111 number, the destination fax is 43130222 and the secret key is "MySecretKey":

```
From: User Name <username@example.org>
To: 43130111@mail2fax.example.org
Subject: 43130222
-----
MySecretKey

This is a test fax.

Cheers
```

D.10 Managing Faxes via the REST API

It is possible to send and receive faxes and configure fax settings using the built-in REST API interface.

In subsequent sections you can find examples of using the API for sending, receiving faxes and changing fax settings.

D.10.1 Configuring Fax Settings

D.10.1.1 Retrieving Fax Settings

The following example retrieves the fax settings for the subscriber with ID 3.

```
Method: GET
Content-Type: application/hal+json
```



```
https://127.0.0.1:1443/api/faxserversettings/3
```

The output format is as follows (only the relevant output data is shown):

```
"active" : true,
  "destinations" : [
    {
      "destination" : "user@company.com",
      "filetype" : "PDF14",
      "incoming" : true,
      "outgoing" : true,
      "status" : true
    }
  ],
  "name" : null,
  "password" : null
```

D.10.1.2 Updating Fax Settings

The following example updates a specific parameter. Namely, it deactivates the fax feature for the subscriber with ID 3.

```
Method: PATCH
Content-Type: application/json-patch+json

https://127.0.0.1:1443/api/faxserversettings/3

--data-binary '[ { "op" : "replace", "path" : "/active", "value" : 0 } ]'
```

D.10.2 Sending a Fax

The following request sends a PDF file located at `/tmp/test_fax.pdf` as fax to 431110002 from the subscriber with ID 3.

```
Method: POST
Content-Type: multipart/form-data

https://127.0.0.1:1443/api/faxes/

--form 'json={"destination" : "431110002", "subscriber_id" : 3}' --form 'faxfile=@/tmp/ ↵
test_fax.pdf'
```

D.10.3 Receiving a Fax

All received faxes are stored on the server and can be retrieved on demand. You can retrieve a stored fax by following these steps:

1. Firstly, obtain the internal ID of the fax:

```
Method: GET
Content-Type: application/json

https://127.0.0.1:1443/api/faxes/3
```

This request returns the list of stored faxes for the subscriber with ID 3. One of the available faxes is returned like this:

```
"callee" : "431110002",
"caller" : "431110001",
"direction" : "out",
"duration" : "0",
"filename" : "d9799276-b7d9-454f-98c3-714edf7e3072.tif",
"id" : 5,
"pages" : "1",
"quality" : "8031x7700",
"reason" : "Normal Clearing / SIP 200 OK [1/3]",
"signal_rate" : "14400",
"status" : "SUCCESS",
"subscriber_id" : 1,
"time" : "2016-07-30 09:49:59"
```

2. Now, to retrieve the fax with ID 5, use the following request:

```
Method: GET
Content-Type: application/hal+json

https://127.0.0.1:1443/api/faxerecordings/5
```

By default, the fax is in the TIFF format. It is also possible to request it in a different format. To retrieve the same fax in PDF14, use the following request:

```
https://127.0.0.1:1443/api/faxerecordings/5?format=pdf14
```

D.10.4 Configuring Mail2Fax Settings

The configuration of Mail2Fax settings via the REST API is similar to the fax settings configuration.

D.10.4.1 Retrieving Mail2Fax Configuration

To get the Mail2Fax configuration for the subscriber with ID 3, use the following request:

```
Method: GET
Content-Type: application/hal+json

https://127.0.0.1:1443/api/mailtofaxsettings/3
```

The output format is as follows (only the relevant output data is shown):

```
"acl" : [],
"active" : false,
"secret_key" : "secretkeypassword",
"secret_key_renew" : "daily",
"secret_renew_notify" : [
  {
    "destination" : "user1@company.com"
  }
]
```

D.10.4.2 Updating Mail2Fax Configuration

The following set of requests changes the Mail2Fax configuration with new secret key settings.

- Secret key value:

```
Method: PATCH
Content-Type: application/json-patch+json

https://127.0.0.1:1443/api/faxserversettings/3

--data-binary '[ { "op" : "replace", "path" : "/secret_key", "value" : " ↵
newsecretkeypassword" } ]'
```

- Secret key renewal interval:

```
Method: PATCH
Content-Type: application/json-patch+json

--data-binary '[ { "op" : "replace", "path" : "/secret_key_renew", "value" : "monthly" } ↵
]'
```

- List of email addresses that receive the automatic secret key update notifications:

```
Method: PATCH
Content-Type: application/json-patch+json

--data-binary '[ { "op" : "replace", "path" : "/secret_renew_notify", "value" : [ { " ←
  destination": "user2@company.com" }, { "destination": "user3@company.com" } ] } ]'
```

D.10.5 Using Advanced Faxserver and Mail2Fax Settings via the REST API

On Sipwise C5 REST API documentation web page you can find the complete list of available Faxserver and Mail2Fax configuration parameters: https://<ngcp_ip_address>:1443/api



Important

The information on the web page is relevant for your platform version and may change in next releases.

After visiting the API documentation main page, you can find the following entries related to Faxserver operations:

- Faxes (https://<ngcp_ip_address>:1443/api/#faxes)
- FaxRecordings (https://<ngcp_ip_address>:1443/api/#faxrecordings)
- FaxserverSettings (https://<ngcp_ip_address>:1443/api/#faxserversettings)

D.11 Troubleshooting

The following log file may be used to check Faxserver functionality: `/var/log/ngcp/faxserver.log`

D.11.1 Session ID (SID)

Faxserver stores basic information about each processed fax in a session file. The most important element within this set of data is the *Session ID* (SID) that uniquely identifies a fax throughout its lifetime.

Session ID is a long hexadecimal string (a kind of UUID) that can be read from the above mentioned Faxserver logfile, and which itself is used also as the filename in files that belong to a specific sent / received fax. An example:

```
root@sp1:~# cat /ngcp-data/spool/faxserver/failed/1e480167-5de6-4cc2-948b-de58d1a0bb8c.err

created: 2016-09-06 04:41:32
caller: 111111111
```

```
callee: 222222222
file: 1e480167-5de6-4cc2-948b-de58d1a0bb8c.tif
sid: 1e480167-5de6-4cc2-948b-de58d1a0bb8c
dir: out
attempts: 0
fail_attempts: 3
fail_retry_secs: 60
quality: normal
status: FAILED
error: Internal error
modified: 2016-09-06 17:41:30

root@sp1:~#
```

The data element `sid` is the session ID. Other important elements are:

- `caller` and `callee`: these are probably searched for when trying to figure out what happened to a specific fax transmission, if you don't know the SID
- `dir`: direction of fax transmission: *in'coming* or *'out'going* or *'mtf* for mail-to-fax
- `status`: shows success or failure
- `error`: the error cause in case of failed faxes

D.11.2 Fax Storage Location

Faxserver stores all of its processed faxes at the path: `/ngcp-data/spool/faxserver/...` Within that directory the most relevant subdirectories are `failed` and `completed` that store the SID file and the fax itself in TIFF format of those faxes that failed or were successful, respectively.

D.12 Adjusting the PBX Devices Configuration

Usually, everything required for PBX devices autoprovisioning is uploaded automatically as described in Section 18.1.1. In case you would like to introduce changes into a PBX device configuration, create a custom PBX device profile or even upload a newer firmware, this section will help you.

The *Device Management* is used by admins and resellers to define the list of device models, firmwares and configurations available for end customer usage. These settings are pre-configured for the default reseller up-front by Sipwise and have to be set up for every reseller separately, so a reseller can choose the devices he'd like to serve and potentially tweak the configuration for them.

[List of available pre-configured devices.](#)

End customers choose from a list of *Device Profiles*, which are defined by a specific *Device Model*, a list of *Device Firmwares* and a *Device Configuration*. The following sections describe the setup of these components.

To do so, go to *Settings*→*Device Management*.

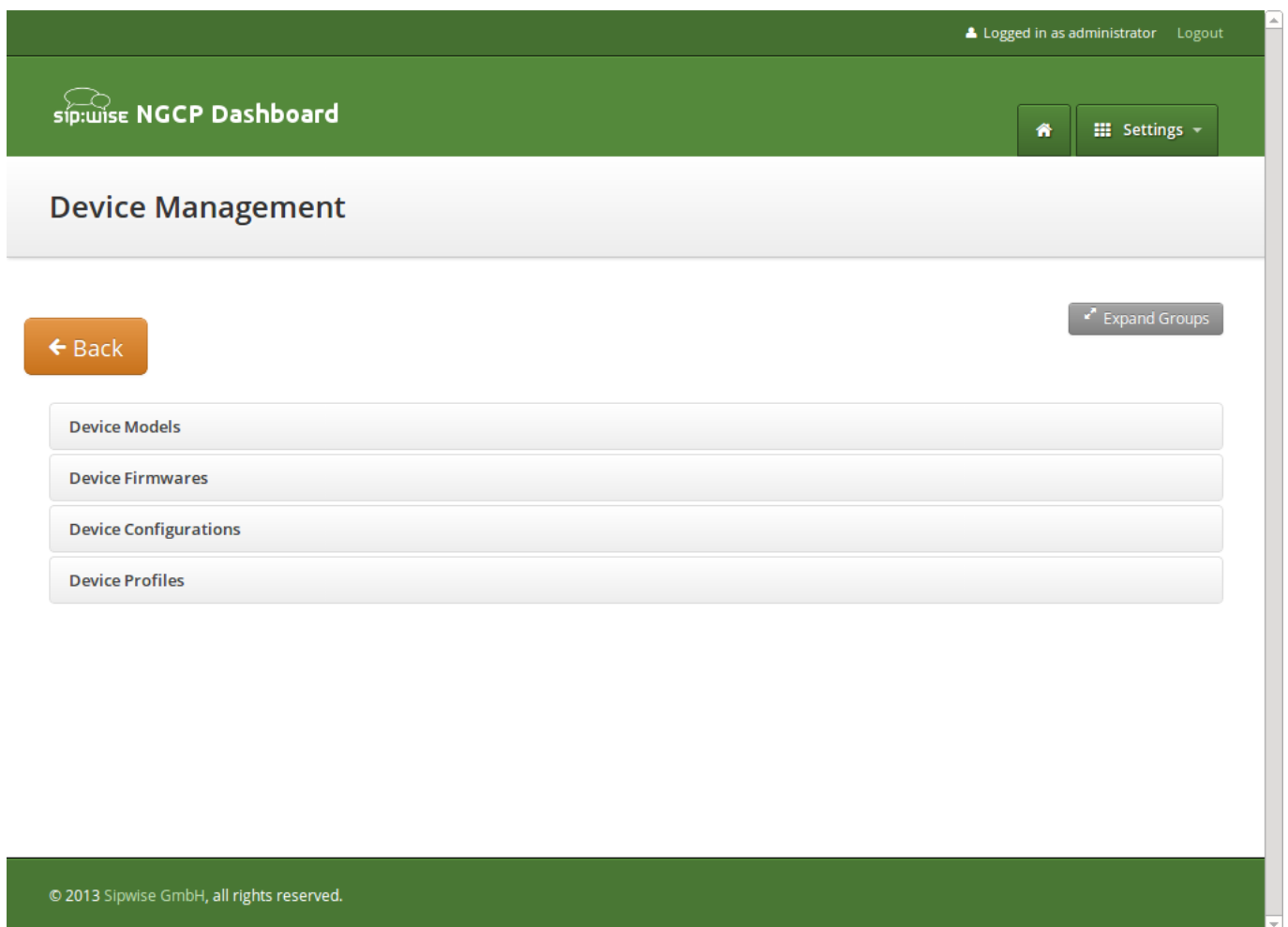

Figure 184: Device Management

D.12.1 Setting up Device Models

A *Device Model* defines a specific hardware device, like the vendor, model name, the number of keys and their capabilities. For example a Cisco SPA504G has 4 keys, which can be used for private lines, shared lines (SLA) and busy lamp field (BLF). If you have an additional attendant console, you get 32 more buttons, which can only do BLF.

In this example, we will create a Cisco SPA504G with an additional Attendant Console.

Expand the *Device Models* row and click *Create Device Model*.

First, you have to select the reseller this device model belongs to, and define the vendor and model name.

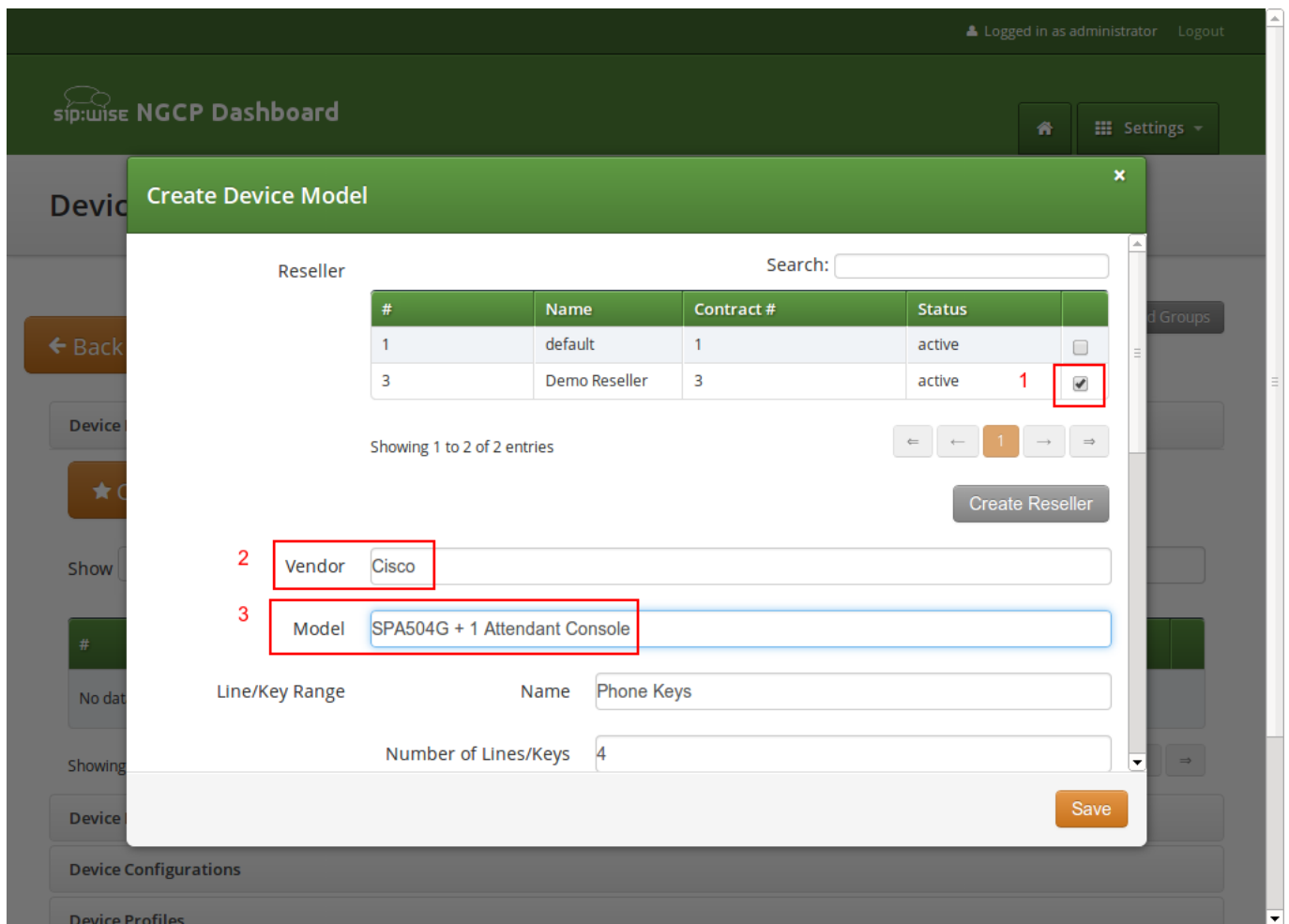

Figure 185: Create Device Model Part 1

In the *Line/Key Range* section, you can define the first set of keys, which we will label *Phone Keys*. The name is important, because it is referenced in the configuration file template, which is described in the following sections. The SPA504G internal phone keys support private lines (where the customer can assign a normal subscriber, which is used to place and receive standard phone calls), shared lines (where the customer can assign a subscriber which is shared across multiple people) and busy lamp field (where the customer can assign other subscribers to be monitored when they get a call, and which also acts as speed dial button to the subscriber assigned for BLF), so we enable all 3 of them.

The screenshot shows the 'Create Device Model' dialog in the NGCP Dashboard. The dialog is titled 'Create Device Model' and has a close button (X) in the top right corner. The fields are as follows:

- Vendor: Cisco
- Model: SPA504G + 1 Attendant Console
- Line/Key Range: 4
- Name: Phone Keys
- Number of Lines/Keys: 4
- Supports Private Line:
- Supports Shared Line:
- Supports Busy Lamp Field:

At the bottom right of the dialog, there are two buttons: 'Remove' and 'Save'.

Figure 186: Create Device Model Part 2

In order to also configure the attendant console, press the *Add another Line/Key Range* button to specify the attendant console keys.

Again provide a name for this range, which will be `Attendant Console 1` to match our configuration defined later. There are 32 buttons on the attendant console, so set the number accordingly. Those 32 buttons only support BLF, so make sure to **uncheck** the private and shared line options, and only check the `busy lamp field` option.

9 Name Attendant Console 1

10 Number of Lines/Keys 32

11 Supports Private Line

Supports Shared Line

12 Supports Busy Lamp Field

Remove

Add another Line/Key Range

Save

Figure 187: Create Device Model Part 3

The last two settings to configure are the *Front Image* and *MAC Address Image* fields. Upload a picture of the phone here in the first field, which is shown to the customer for him to recognize easily how the phone looks like. The MAC image is used to tell the customer where he can read the MAC address from. This could be a picture of the back of the phone with the label where the MAC is printed, or an instruction image how to get the MAC from the phone menu.

The rest of the fields are left at their default values, which are set to work with Cisco SPAs. Their meaning is as follows:

- *Bootstrap Sync URI*: If a stock phone is plugged in for the first time, it needs to be provisioned somehow to let it know where to fetch its configuration file from. Since the stock phone doesn't know about your server, you have to define an HTTP URI here, where the customer is connected with his web browser to set the according field.
- *Bootstrap Sync HTTP Method*: This setting defines whether an HTTP GET or POST is sent to the Sync URI.
- *Bootstrap Sync Params*: This setting defines the parameters appended to the Sync URI in case of a GET, or posted in the request body in case of POST, when the customer presses the *Sync* button later on.

Finally press *Save* to create the new device model.

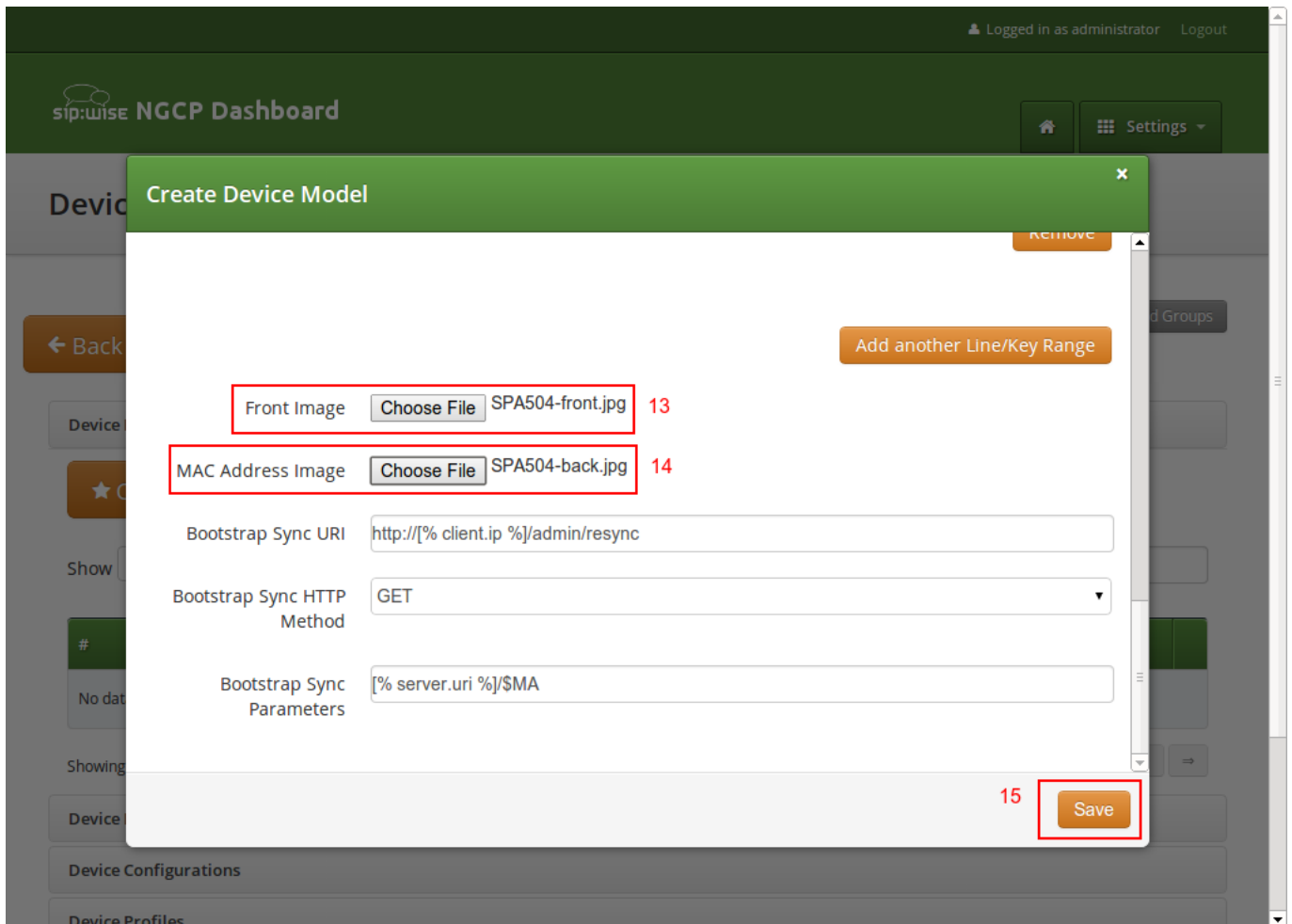

Figure 188: Create Device Model Part 4

D.12.2 Uploading Device Firmwares

A device model can optionally have one or more device firmware(s). Some devices like the Cisco SPA series don't support direct firmware updates from an arbitrary to the latest one, but need to go over specific firmware steps. In the device configuration discussed next, you can return the *next* supported firmware version, if the phone passes the current version in the firmware URL.

Since a stock phone purchased from any shop can have an arbitrary firmware version, we need to upload all firmwares needed to get from any old one to the latest one. In case of the Cisco SPA3x/SPA5x series, that would be the following versions, if the phone starts off with version 7.4.x:

- spa50x-30x-7-5-1a.bin
- spa50x-30x-7-5-2b.bin
- spa50x-30x-7-5-5.bin

So to get an SPA504G with a firmware version 7.4.x to the latest version 7.5.5, we need to upload each firmware file as follows.

Open the *Device Firmware* row in the *Device Management* section and press *Upload Device Firmware*.

Select the device model we're going to upload the firmware for, then specify the firmware version and choose the firmware file, then press *Save*.

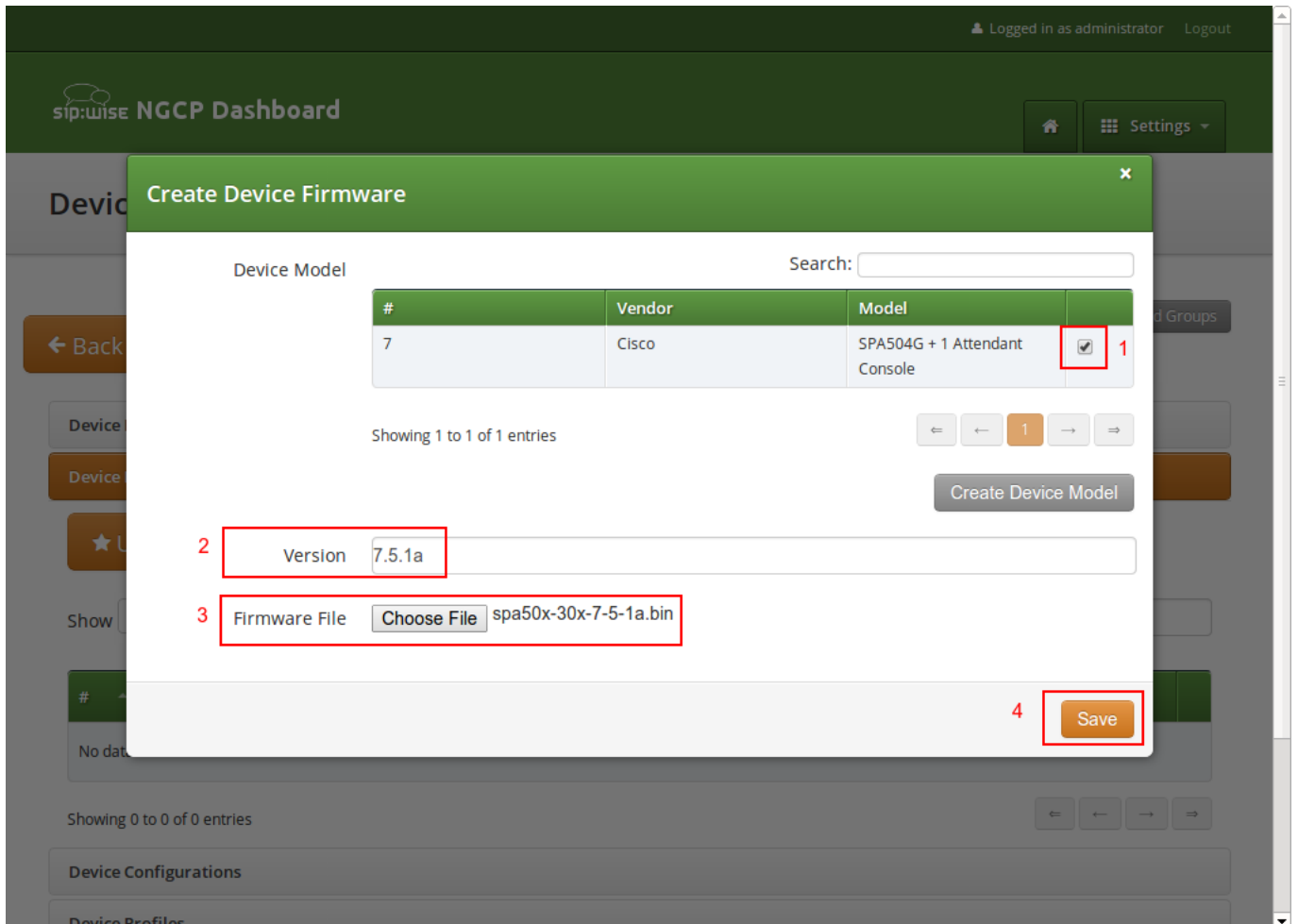

Figure 189: Upload Device Firmware

Repeat this step for every firmware in the list above (and any new firmware you want to support when it's available).

D.12.3 Creating Device Configurations

Each customer device needs a configuration file, which defines the URL to perform firmware updates, and most importantly, which defines the subscribers and features configured on each of the lines and keys. Since these settings are different for each physical phone at all the customers, the Cloud PBX module provides a template system to specify the configurations. That way, template variables can be used in the generic configuration, which are filled in by the system individually when a physical device fetches its configuration file.

To upload a configuration template, open the *Device Configuration* row and press *Create Device Configuration*.

Select the device model and specify a version number for this configuration (it is only for your reference to keep track of different

versions). For Cisco SPA phones, keep the *Content Type* field to `text/xml`, since the configuration content will be served to the phone as XML file.

For devices other than the Cisco SPA, you might set `text/plain` if the configuration file is plain text, or `application/octet-stream` if the configuration is compiled into some binary form.

Finally paste the configuration template into the *Content* area and press *Save*.

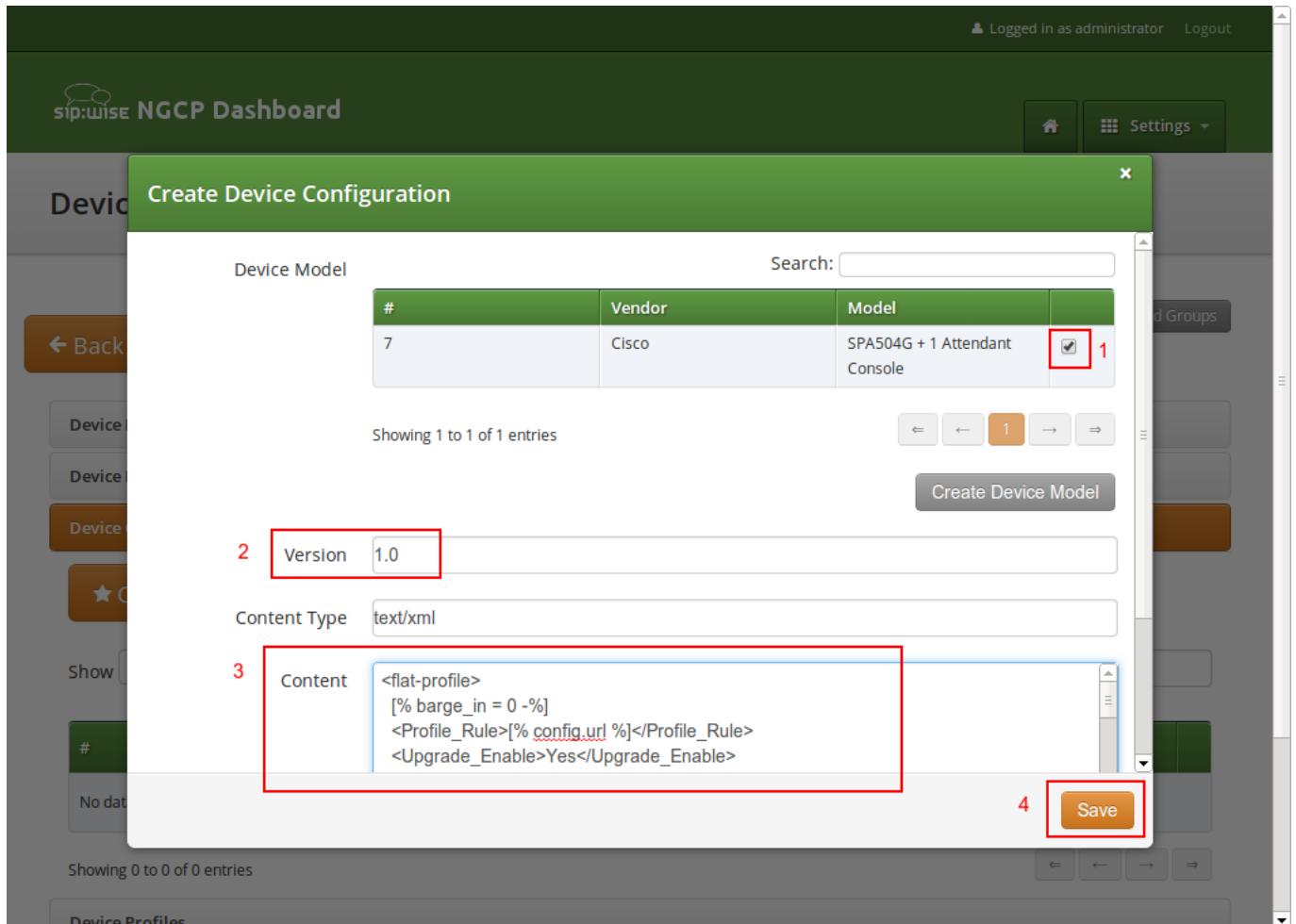

Figure 190: Upload Device Configuration

The templates for certified device models are provided by Sipwise, but you can also write your own. The following variables can be used in the template:

- `config.url`: The URL to the config file, including the device identifier (e.g. `http://sip.example.org:1444/device/autoprovisioning/1444/`).
- `firmware.maxversion`: The latest firmware version available on the system for the specific device.
- `firmware.baseurl`: The base URL to download firmwares (e.g. `http://sip.example.org:1444/device/autoprovisioning/1444/`). To fetch the next newer firmware for a Cisco SPA, you can use the template line `[% firmware.baseurl %]/$MA/from/$SWVERSION`.
- `phone.stationname`: The name of the station (physical device) the customer specifies for this phone. Can be used to show on the display of the phone.

- `phone.lineranges`: An array of lines/keys as specified for the device model. Each entry in the array has the following keys:
 - `name`: The name of the line/key range as specified in the *Device Model* section (e.g. `Phone Keys`).
 - `num_lines`: The number of lines/keys in the line range (e.g. 4 in our `Phone Keys` example, or 32 in our `Attendant Console 1` example).
 - `lines`: An array of lines (e.g. subscriber definitions) for this line range. Each entry in the array has the following keys:
 - * `keynum`: The index of the key in the line range, starting from 0 (e.g. `keynum` will be 3 for the 4th key of our `Phone Keys` range).
 - * `rangenum`: The index of the line range, starting from 0. The order of line ranges is as you have specified them (e.g. `Phone Keys` was specified first, so it gets `rangenum 0`, `Auto Attendant 1` gets `rangenum 1`).
 - * `type`: The type of the line/key, on of `private`, `shared` or `blf`.
 - * `username`: The SIP username of the line.
 - * `domain`: The SIP domain of the line.
 - * `password`: The SIP password of the line.
 - * `displayname`: The SIP Display Name of the line.

In the configuration template, you can adjust embedded variable references for the existing variables. If you need other specific variables, please request their development from Sipwise.

Tip

In order to change the provisioning base IP and port (default 1444), you have to access `/etc/ngcp-config/config.yml` and change the value `host` and `port` under the `autoprov.server` section.

D.12.4 Creating Device Profiles

When the customer configures his own device, he doesn't select a *Device Model* directly, but a *Device Profile*. A device profile specifies which model is going to be used with which configuration version. This allows the operator to create new configuration files and assign them to a profile, while still keeping older configuration files for reference or roll-back scenarios. It also makes it possible to test new firmwares by creating a test device model with the new firmware and a specific configuration, without impacting any existing customer devices.

To create a *Device Profile* for our phone, open the *Device Profile* row in the *Device Management* section and press *Create Device Profile*.

Select the device configuration (which implicitly identifies a device model) and specify a *Profile Name*. This name is what the customer sees when he is selecting a device he wants to provision, so pick a descriptive name which clearly identifies a device. Press *Save* to create the profile.

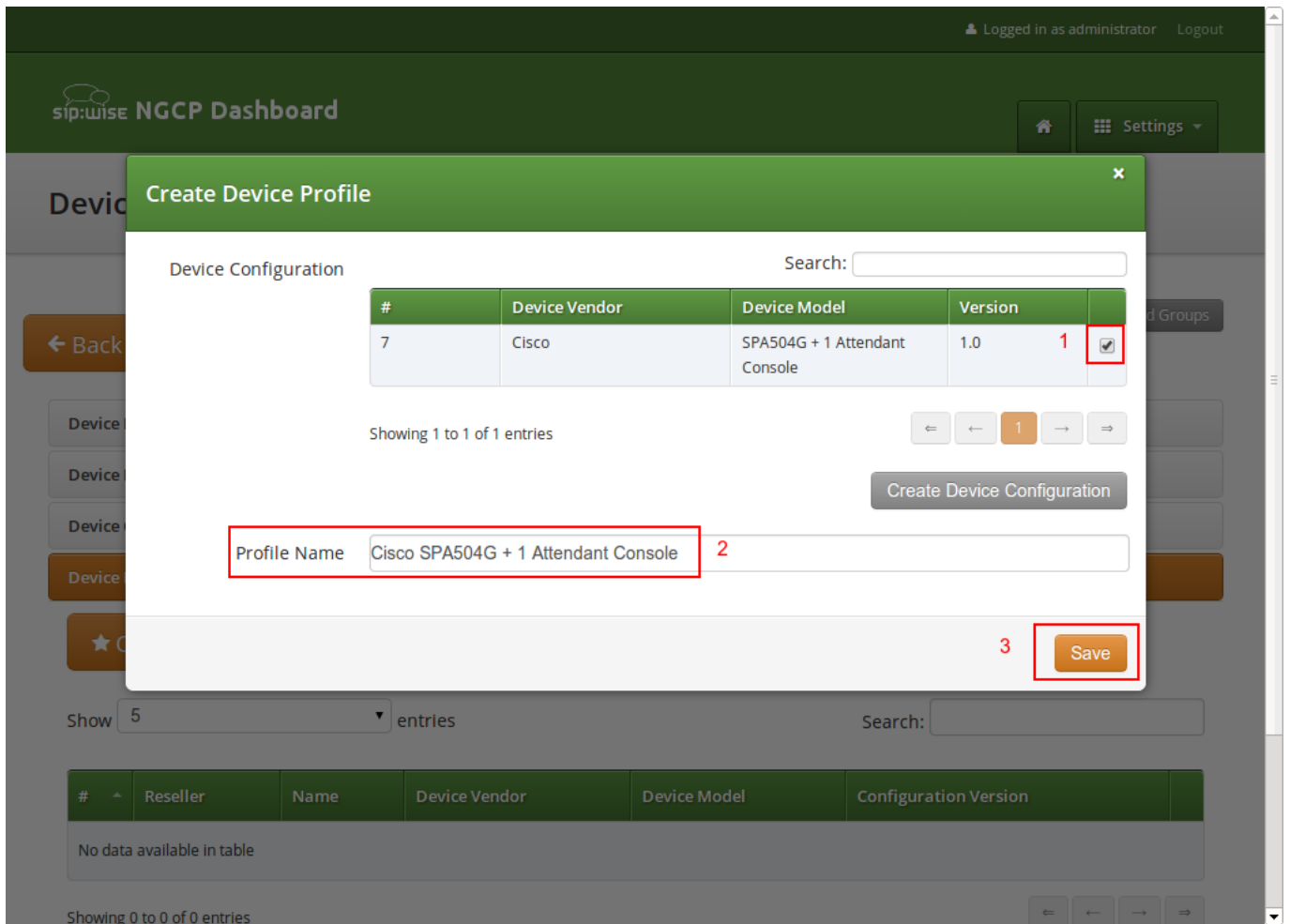

Figure 191: Create Device Profile

Repeat the steps as needed for every device you want to make available to customers.

E RTC:engine

E.1 Overview

WebRTC is an open project providing browsers and mobile applications with Real-Time Communications (RTC) capabilities. The RTC:engine protocol is a light weight messaging and signaling protocol for WebSocket clients. Technically it is a WebSocket sub protocol. It consists of JSON messages that are used to initiate and control call dialogs, send chat messages, join and control conferences and share files. It is similar to well known signaling protocols like SIP, but much simpler. It does not care about the underlying network protocols, like SIP does.

E.2 RTC:engine enabling

The RTC:engine is not activated by default and needs a few steps to setup.

E.2.1 Enabling services via CLI

First you have to enable it first on your server via CLI. Connect with SSH on your server, open `/etc/ngcp-config/config.yml` with your editor of choice and change the following properties:

```
fileshare:
  enable: yes

rtcengine:
  conference:
    relay:
      app_id: bormuth
      url: http://xms.sipwise.com:81
  call:
    relay:
      app_id: bormuth
      url: http://xms.sipwise.com:81
  enable: yes
  expose_provisioning_api: yes

www_admin:
  http_csc:
    servername: '$IP_OF_VM'
```

Save the config.yml file and run `$ ngcpcfg apply "enable rtcengine"`. After the script ran, check the status of all services via `$ ngcp-service summary`, or `$ systemctl status`.

E.2.2 Enabling via Panel for resellers and subscribers

The WebRTC subscriber is just a normal subscriber which has just a different configuration in his Preferences. You need to change the following preferences under *Subscribers*→*Details*→*Preferences*→*NAT and Media Flow Control*:

- **use_rtpproxy**: Always with rtpproxy as additional ICE candidate
- **transport_protocol**: RTP/SAVPF (encrypted SRTP with RTCP feedback)

The `transport_protocol` setting may change, depending on your WebRTC client/browser configuration. Supported protocols are the following:

- Transparent (Pass through using the client's transport protocol)
- RTP/AVP (Plain RTP)
- RTP/SAVP (encrypted SRTP)
- RTP/AVPF (RTP with RTCP feedback)
- RTP/SAVPF (encrypted SRTP with RTCP feedback)
- UDP/TLS/RTP/SAVP (Encrypted SRTP using DTLS)
- UDP/TLS/RTP/SAVPF (Encrypted SRTP using DTLS with RTCP feedback)



Warning

The below configuration is enough to handle a WebRTC client/browser. As mentioned, you may need to tune a little bit your `transport_protocol` configuration, depending on your client/browser settings.

In order to have a bridge between normal SIP clients (using plain RTP for example) and WebRTC client, the normal SIP clients' preferences have to have the following configuration:

transport_protocol: RTP/AVP (Plain RTP)

This will teach Sipwise C5 to translate between Plain RTP and RTP/SAVPF when you have calls between normal SIP clients and WebRTC clients.

E.2.3 Create RTC:engine session

E.2.3.1 Create sessions

Request:

```
curl -i -X POST --insecure --user SUBSCRIBER_ID:SUBSCRIBER_PW -H 'Content-Type: application <↔
  /json' --data-binary '{} ' https://IP_OF_VM/api/rtcsessions/
```

Response Header:

```
Location: /api/rtcsessions/7
```

E.2.3.2 Receive sessions**Request:**

```
curl -i -X GET --insecure --user SUBSCRIBER_ID:SUBSCRIBER_PW -H 'Content-Type: application/ ↵  
json' https://IP_OF_VM/api/rtcsessions/{ID_FROM_LAST_REQUEST_HEADER}
```

Response Header:

```
{  
  ...  
  "rtc_app_name" : "default_default_app",  
  "rtc_browser_token" : "22fz8e51-ad6e-481e-a389-15c58c3fe5ac",  
  "rtc_network_tag" : "",  
  "subscriber_id" : "263"  
}
```

Tip

Use `rtc_browser_token` in your `cdk.Client`.

E.3 RTC:engine protocol details**E.3.1 Terminology****E.3.1.1 Connector**

There are two kinds of connectors. The front and the back connectors. The only front connector is the `BrowserConnector`. It has access to all `WebSocket` connections and is responsible for delivering RCT:engine protocol messages to the `WebSocket` clients, and for forwarding messages from the `WebSocket` clients to the router.

Currently there are four back connectors (`SipConnector`, `XmppConnector`, `WebrtcConnector`, `ConferenceConnector`). Every back connector implements a certain communication use case.

E.3.1.2 Router

The router is very simple stateless message broker, that is responsible for delivering the messages to the right connector. To decide where to send the message, the router takes a look at the recipient address (to) and forwards the message to the specified connector.

E.3.1.3 User

E.3.1.4 App

An app is a scope for a certain RTC:engine integration. Every user can have multiple apps. And an app contains sessions.

E.3.1.5 Network

A network is a user wide configuration, that maps a custom network name (tag) to a certain back connector. Additionally it can also store network specific configurations. And any account that is related to a certain network, will merge its custom configs with the network configs, and send its messages to the specified connector.

E.3.1.6 Session

E.3.1.7 Account

An account represents the credentials for a specific network. Usually it consists of an identifier like a SIP uri (sip:user@domain.tld) and an access token or rather a password.

E.3.1.8 Browser SDK

The Browser SDK is an abstraction layer on top of the RTC:engine protocol. It is served as bundled javascript library, and provides convenient components and methods for all use cases.

E.3.2 Messages

A typical message created by the browser sdk contains the following fields:

```
{
  "method": "module.action",
  "from": "connector:id",
  "to": "connector:id",
  "session": "session",
  "body": {
    ...
  }
}
```

```
}
```

E.3.2.1 Fields

E.3.2.2 method

It is separated in two parts. The first part is the module. It is a delegation key to separate concerns in the code. The second part is the action, which represents a specific method in a module.

E.3.2.3 from

It represents the current sender of a message. For example the user creates a new call via the browser sdk, the message would look like this:

```
{
  "method": "call.start",
  "from": "",
  "to": "webrtc:b2bua1",
  "session": "session1",
  "body": {
    ...
  }
}
```

The content of the field is completely irrelevant, because the BrowserConnector will overwrite this field. The reason is to avoid user manipulation.

```
{
  "method": "call.start",
  "from": "browser:wsl",
  "to": "webrtc:b2bua1",
  "session": "session1",
  "body": {
    ...
  }
}
```

E.3.2.4 to

In general this field represents the recipient of a message. The recipients address consists of two parts. First part is the prefix that targets the connector. Second part is the identifier of the recipient.

E.3.2.5 session

If you provisioned with the RTCEngine, you get a session and its token property. The browser SDK adds this token to every message.

E.3.2.6 body

The body contains the payload of the message. Every message type has its own body schema.

E.3.3 Account

Mainly an account consists of credentials (identifier, accessToken), that are needed to authenticate against the related network. Its lifecycle is bound to the lifecycle of the related session.

After RTC:engine received session.open, it responds a session.validated message. This message contains all provisioned accounts in its property "body.accounts".

E.3.3.1 Flow

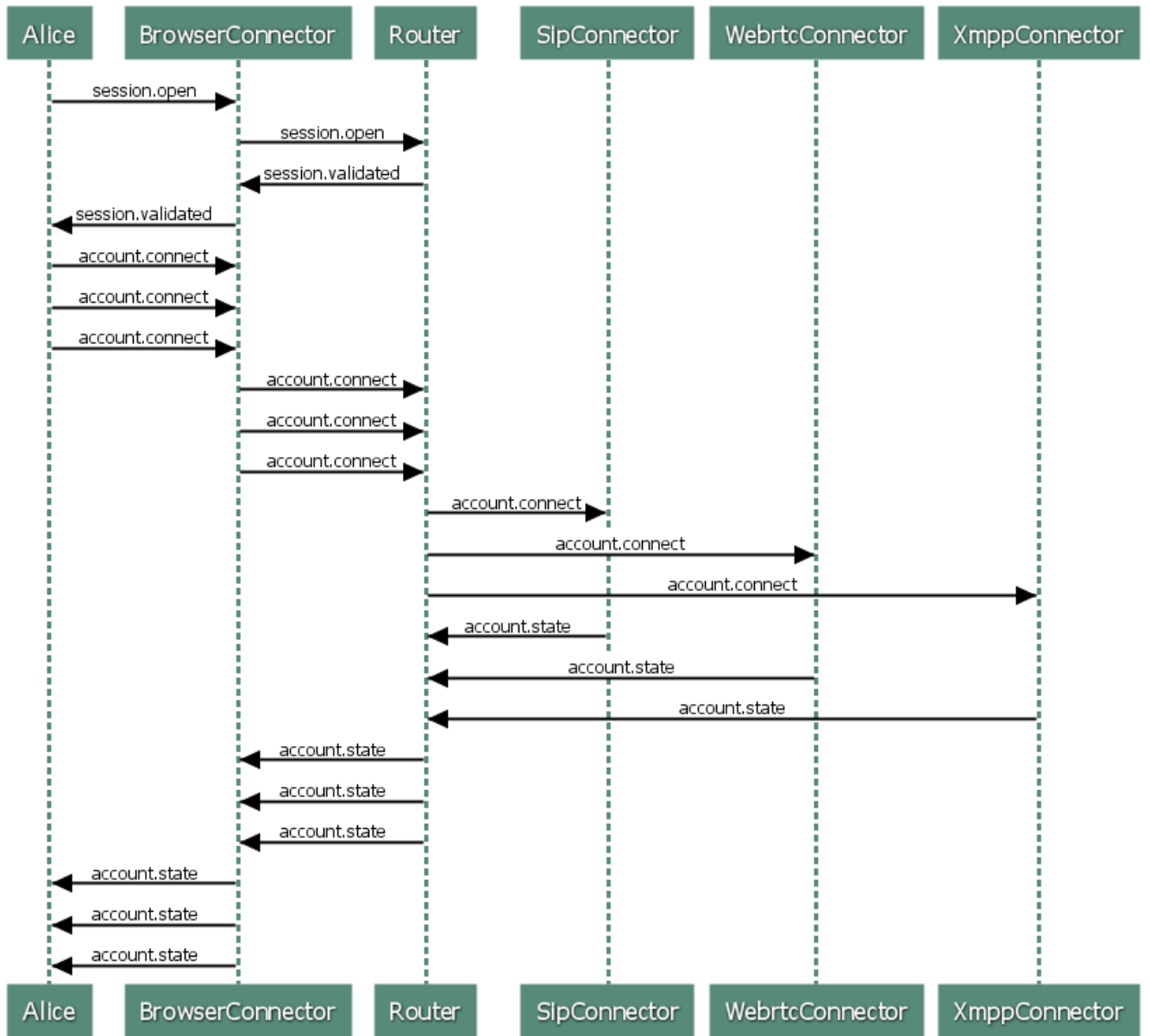

www.websequencediagrams.com

E.3.3.2 Messages

E.3.3.3 account.connect

RTC:engine needs one message per account. The message should contain the id of the account. The id is the object key in the accounts object from the [session.validated](../session/index.md) message.

```

{
  "from": "",

```

```
"to": "...:...",
"method": "account.connect",
"session": "...",
"body": {
  "id": "..."
}
}
```

E.3.3.4 account.state

This message gives state information about the authentication and registration process of the related network and the corresponding connector. For example, if the related connector is the SipConnector, it creates a new SIP B2BUA in background, and notify the browser if any state change happens.

```
{
  "from": "...:...",
  "to": "browser:...",
  "method": "account.state",
  "session": "...",
  "body": {
    "id": "...",
    "reason": "...",
    "state": "..."
  }
}
```

E.3.3.5 State reasons

- OK
- CONNECTING
- DISCONNECTING
- SERVICE_UNAVAILABLE
- SERVICE_ERROR
- BAD_CONFIGURATION
- WRONG_CREDENTIALS
- CONNECTOR_UNAVAILABLE
- CONNECTOR_BUSY
- CONNECTOR_ERROR
- ACCOUNT_NOT_FOUND

E.3.3.6 States

- CONNECTED
- DISCONNECTED

E.3.4 Call

E.3.4.1 Flow

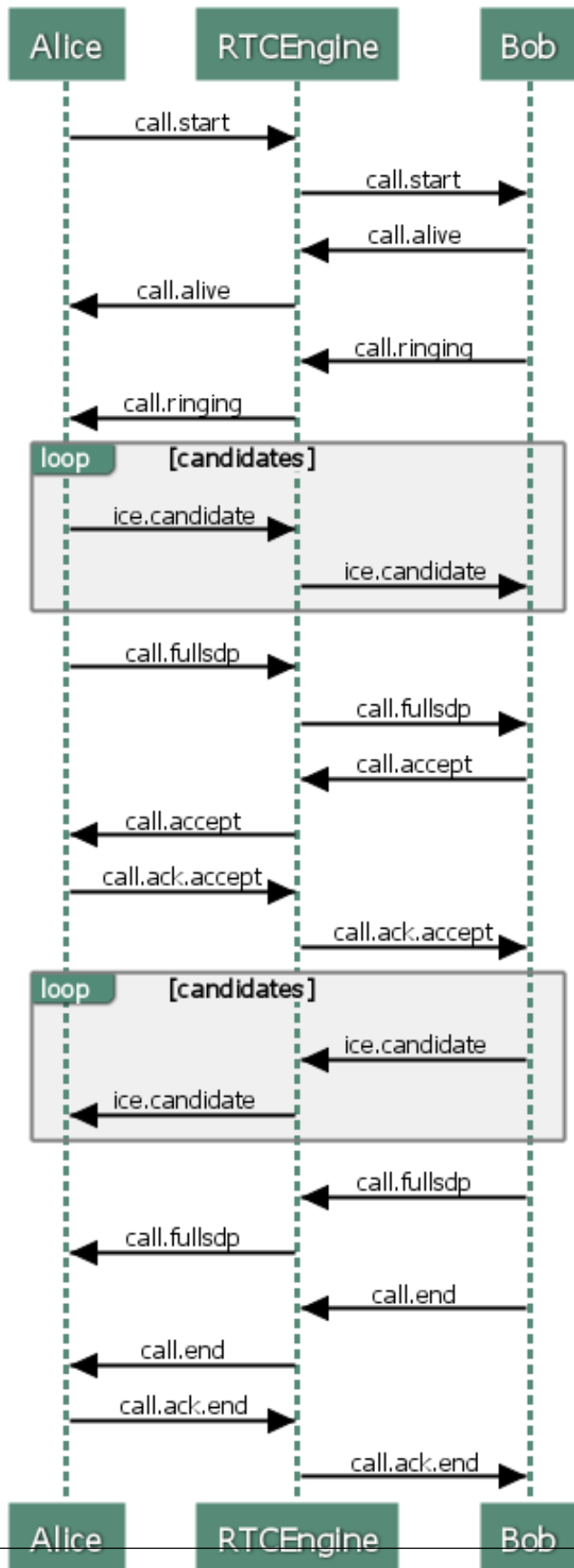

E.3.4.2 call.start

The caller sends this message to the RTC:engine to initiate a new call dialog.

```
{
  "from": "local",
  "to": ["...:..."],
  "method": "call.start",
  "session": "...",
  "body": {
    "id": "...",
    "gcid": "...",
    "account": "...",
    "replace": true|false,
    "trickle": true|false,
    "target": "...",
    "sdp": "..."
  }
}
```

E.3.4.3 Body properties

E.3.4.4 id

The id is a UUID version 4 that identifies the call dialog in the system. But caller and callee never have the same.

E.3.4.5 gcid

Whereas the gcid is a system wide and end-to-end consistent call identifier. It is necessary to track the entire call dialog.

E.3.4.6 account

It contains the callers account id. [(See accounts)](../account/index.md)

E.3.4.7 replace

This property is not used yet. It should support a call handover scenario.

E.3.4.8 trickle

If is set to true, the callee expects ice candidates, before the full sdp delivered by the caller, to accelerate the negotiation process.

E.3.4.9 target

It's the URI (sip:user@domain.tld) of the callee.

E.3.4.10 sdp

The sdp property contains a very early state of the browsers media machine. It contains no ice candidates so far.

E.3.4.11 call.alive

After the callee received the "call.start" message, it responds with a "call.alive" to the RTC:engine, immediately.

```
{
  "from": "...",
  "to": "...",
  "method": "call.alive",
  "session": "...",
  "body": {
    "id": "...",
    "gcid": "..."
  }
}
```

E.3.4.12 call.ringing

After the callee received the "call.start" message, it responds with a "call.ringing" to the RTC:engine, immediately.

```
{
  "from": "...",
  "to": "...",
  "method": "call.ringing",
  "session": "...",
  "body": {
    "id": "...",
    "gcid": "...",
    "account": null
  }
}
```

E.3.4.13 call.accept

The callee sends this message after accepting the call explicitly.

```
{
  "from": "...",
  "to": "...",
  "method": "call.accept",
  "session": "...",
  "body": {
    "id": "...",
    "gcid": "...",
    "account": null,
    "trickle": true|false,
    "sdp": "..."
  }
}
```

E.3.4.14 call.ack.accept

Caller sends this message after it received the "call.accept" message from the callee.

```
{
  "from": "...",
  "to": "...",
  "method": "call.ack.accept",
  "session": "...",
  "body": {
    "id": "...",
    "gcid": "..."
  }
}
```

E.3.4.15 call.candidate

Both, caller and callee send ice candidates immediately after initiating respectively accepting the call.

```
{
  "from": "...",
  "to": "...",
  "method": "call.candidate",
  "session": "...",
  "body": {
    "id": "...",
    "gcid": "...",
    "candidate": {
```

```
    "payload": "...",
    "type": "WEBRTC_LEGACY"
  }
}
```

E.3.4.16 call.fullsdp

Both, caller and callee send this message after the ice gathering finished and all candidates are available.

```
{
  "from": "...",
  "to": "...",
  "method": "call.fullsdp",
  "session": "...",
  "body": {
    "id": "...",
    "gcid": "...",
    "sdp": "..."
  }
}
```

E.3.4.17 call.change....

All messages, that begin with "call.change", are important for renegotiation and glare handling.

E.3.4.18 call.change.lock.reset

E.3.4.19 call.change.lock

E.3.4.20 call.change.lock.ok

E.3.4.21 call.change.offer

E.3.4.22 call.change.answer

E.3.4.23 call.dtmf

Only works if the connector of the related account supports DTMF messages.

```
{
  "from": "...",
```

```
"to": "...",
"method": "call.dtmf",
"session": "...",
"body": {
  "id": "...",
  "gcid": "...",
  "dtmf": "...",
  "account": null
}
}
```

E.3.4.24 call.end

Both, caller and callee can send this message. It forces the counter part to end and destroy the call.

```
{
  "from": "...",
  "to": "...",
  "method": "call.end",
  "session": "...",
  "body": {
    "id": "...",
    "gcid": "...",
    "reason": "..."
  }
}
```

E.3.4.25 call.ack.end

The counter part, that receives the "call.end" message, sends the "call.ack.end" message.

```
{
  "from": "...",
  "to": "...",
  "method": "call.ack.end",
  "session": "...",
  "body": {
    "id": "...",
    "gcid": "...",
    "account": null
  }
}
```

E.3.5 Session

E.3.5.1 Flow

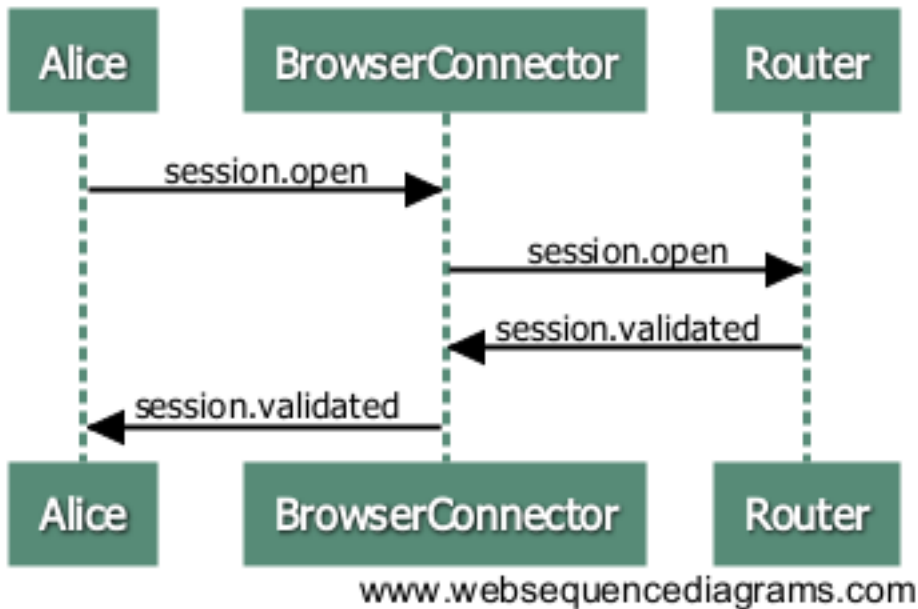

E.3.5.2 Messages

E.3.5.3 `session.open`

```

{
  "method": "session.open",
  "from": "",
  "to": "",
  "session": "session1",
  "body": {
    "credentials": {
      "userSession": "session1"
    }
  }
}

```

E.3.5.4 `session.validated`

This message is the response to **session.open**. If the session property is a valid session, you get a response where the result property is true. In addition you get the account information to connect to the networks.

```
{
  "method": "session.validated",
  "from": "core",
  "to": "browser:wsl",
  "session": "session1"
  "body": {
    "result": true,
    "accounts": {
      "account1": {
        "identifier": "sip:account1@foo.bar"
        "target": "sip-connector:b2bua-account1",
        "network": {
          "tag": "sip-network"
        }
      }
    }
  },
}
```

If something went wrong, result is set to false and an error reason appears.

```
{
  "method": "session.validated",
  "from": "core",
  "to": "browser:wsl",
  "session": "session1"
  "body": {
    "result": false,
    "reason": {
      "type": "invalidToken",
      "message": "Your token is not a valid user session token!"
    }
  }
},
}
```

E.3.5.5 Reason types

- invalidToken
- tokenExpired
- missingCredentials

F comx-fileshare-service

F.1 Overview

The *comx-fileshare-service* is a Node.js (4.4.0) based filesharing service and it is intended to be used via REST API. This service allows you to upload arbitrary files to the server and to download/share them with a generated link.

The API can be used with in 2 ways:

- with **simple identification**, which means that only credentials of a user/subscriber are needed for authentication
- with **session identification**, which also provides for example the time-to-live (TTL) functionality besides authentication, and will be used in combination with the *RTC:engine*.

F.2 Configuration and Usage

F.2.1 Change authentication method

To use Sipwise C5 subscribers as authentication against the API, you need to set it in the *comx-fileshare-service* `config.js`:

```
simpleUpload: {
  authentication: {
    enabled: true,
    subscriber: true,
    username: 'foo8',
    password: 'bar8'
  }
}
```

You can now authenticate like this with the API:

```
curl -i -X POST --insecure --form file=@/tmp/test.txt --user '43991002@domain.tld:x43991002 ←
' \
https://$NGCP_IP:1446/rtc/fileshare/uploads
```

If you want to use the credentials from the `config.js` you need so set it to the following settings:

```
simpleUpload: {
  authentication: {
    enabled: true,
    subscriber: false,
```

```

username: 'foo8',
password: 'bar8'
}
}

```

In this case, the login parameter would be this:

```

curl -i -X POST --insecure --form file=@/tmp/test.txt --user 'foo8:bar8' \
  https://$NGCP_IP:1446/rtc/fileshare/uploads

```

F.2.2 Database Structure

Table information for the *fileshare* database:

- *downloads* table:

Table 30: Details of downloads Table in fileshare Database

Field Name	Field Type	Description
id	CHAR, PRIMARY KEY	Internal ID of the download action
state	ENUM	State of the download
uploaded_id	CHAR, FOREIGN KEY	External ID used for accessing the uploaded file in <i>uploads</i> table
created_at	DATETIME	Download action creation time
updated_at	DATETIME	Time of last download action modification

- *sessions* table:

Table 31: Details of sessions Table in fileshare Database

Field Name	Field Type	Description
id	CHAR, PRIMARY KEY	Internal ID of the session
ttl	INT	Time-to-live value of the session (in seconds)
created_at	DATETIME	Session creation time
updated_at	DATETIME	Time of last session modification

- *uploads* table:

Table 32: Details of uploads Table in fileshare Database

Field Name	Field Type	Description
id	CHAR, PRIMARY KEY	Internal ID of the file entry
data	LONGBLOB	The file data
original_name	VARCHAR	Original name of the file
mime_type	VARCHAR	MIME type of the file
size	INT	File size in bytes
ttl	INT	Time-to-live value of the file
state	ENUM	State of the file
session_id	CHAR, FOREIGN KEY	External ID used to access session data in <i>sessions</i> table
created_at	DATETIME	File creation / upload time
updated_at	DATETIME	Time of last file modification

F.3 Activation of Filesharing Service on NGCP

The service is installed on every Sipwise C5 system, but is not activated by default. In order to activate the service with default port 1446, connect with SSH to your server, open `/etc/ngcp-config/config.yml` with your editor of choice and change the `fileshare.enable` property from `no` to `yes`:

```
fileshare:  
  enable: yes  
  external_port: 1446
```

Apply the new configuration in the usual way:

```
ngcpcfg apply 'Enabled comx-fileshare-service'  
ngcpcfg push all
```

and check the status with `ngcp-service summary`. It should be now up and running.

F.4 Message Sequence Chart

F.4.1 Simple Message Sequence

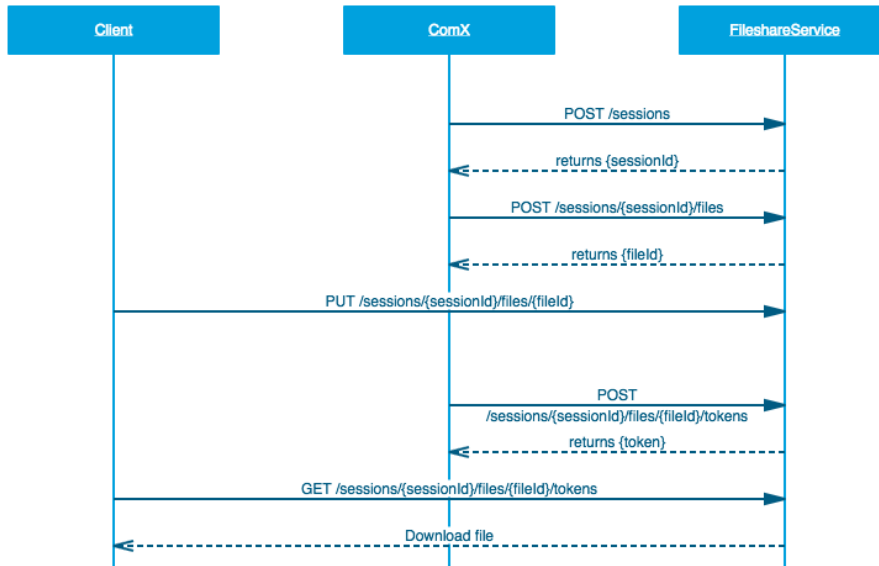

Figure 192: Sequence Simple

F.4.2 Detailed Message Sequence

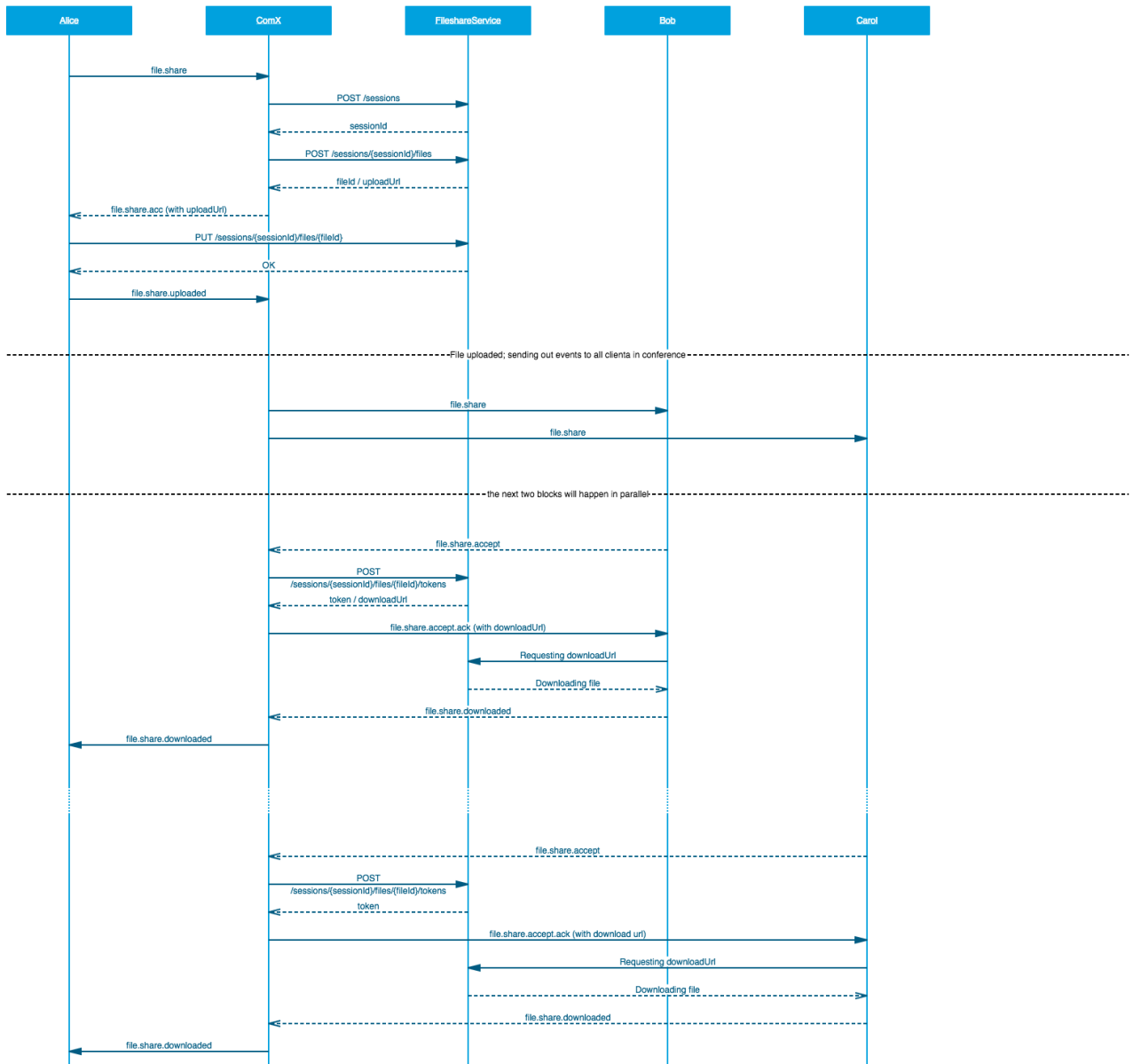

Figure 193: Sequence Detailed

F.5 API of Filesharing Service

F.5.1 HTTP Authentication

Type: Basic Auth
 username/password

F.5.2 Upload and Download with Simple Identification

The following HTTP methods can be used to perform file upload and download:

```
POST /uploads // Simple upload
GET /uploads/{fileId} // Simple download
```

F.5.3 Upload and Download with Session Identification

The following HTTP methods can be used to perform file upload and download, and to manage sessions.

Session identification:

```
GET /sessions/{sessionId}/files // Get all files of a session
GET /sessions/{sessionId}/files/{fileId}/tokens/{tokenId} // Download a single file
POST /sessions // Create a new session
POST /sessions/{sessionId}/files // Create a new file entry
POST /sessions/{sessionId}/files/{fileId}/tokens // Generate a download token
PUT /sessions/{sessionId}/files/{fileId} // Upload and store a file
```

Simple identification:

```
GET /uploads/{fileId} // Get uploaded file
POST /uploads // Upload file
```

F.5.4 Curl Example for Simple Upload Request

```
curl -i -X POST --insecure --form file=@/tmp/test.txt --user 'myuser@example.com:mypass' \
  https://$NGCP_IP:1446/rtc/fileshare/uploads
```

F.5.5 Upload Parameters

F.5.5.1 file

The parameter *file* defines the path to the desired file that should be uploaded.

**Caution**

This upload parameter is mandatory!

Curl example:

```
curl -i -X POST --insecure --form file=@/tmp/test.txt https://$NGCP_IP:1446/rtc/fileshare/ ←
uploads
```

F.5.5.2 user

The parameter *user* defines the user to authenticate with the fileshare service.

**Caution**

This upload parameter is mandatory!

```
curl -i -X POST --insecure --user 'foo:bar' https://$NGCP_IP:1446/rtc/fileshare/uploads
```

F.5.5.3 TTL

The parameter *ttl* defines the time-to-live (in seconds), that is how long the uploaded file will be available for download. The default values for this parameter are defined in the configuration file:

```
models: {
  session: {
    ttl: 86400 * 7
  },
  upload: {
    ttl: 3600
  }
}
```

Curl example:

```
curl -i -X POST --insecure --form file=@/tmp/test.txt --form ttl=3600 \
--user 'foo:bar' https://$NGCP_IP:1446/rtc/fileshare/uploads
```

Response from *curl* when TTL is expired:

```
{  
  "message": "upload expired"  
}
```

Response in the log file when TTL is expired:

```
Error at /uploads/88e5905d-5d96-4750-ab3d-77a1ed26f569: message=upload expired, status=410
```

F.5.6 Number of Possible Downloads

There is a significant difference in the usage of the filesharing service between the approach within the *RTC:engine* and the simple upload/download one:

- If you are using the **simple upload and download** approach, the generated download link you get for your file can be used as many times as required, as long as the TTL is not expired.
- The approach **with the Session ID**, which will be used with the *RTC:engine* implementation, limits the download to one-time only. This means that the generated download link can be used only once. If you plan to share the URL with multiple persons, you have to generate one link for each recipient.

G Disk partitioning

This chapter documents possible disk partitioning on Sipwise C5 available after installation the Sipwise C5. It should be helpful to understand the overall disk partitioning schema.

G.1 Supported IO drives

At the moment the following drives are supported: HDD, SSD, and NVMe. We recommend installing NVMe type SSD storage for the best performance. Otherwise, install SATA SSDs for an average performance as SATA hard disks are a good option only for test/development purpose.

The exact model and size depend on the type of the system and the load. We recommend running the initial performance test on the selected hardware before going into production.

G.2 Hardware vs. software RAID

Depending on the specific hardware specification, Sipwise will configure either RAID 1 for CARRIER or RAID 10 for PRO (HW-RAID, usually for installations with HDDs), or software RAID (SW-RAID, generally for installations with SSDs).

G.3 The default disk partitions

The Sipwise C5 supports the modern concept of installing several releases side by side. The ability to switch between the releases simplifies software upgrades and enables rollbacks. You can find all the benefits here [here](#).

The new partitioning logic is simple. The *code* of services (e.g., kamailio, MariaDB) is separated from the *data* (e.g., databases, CDR files) generated and processed by the *code*, and is located in a different partition of the disk. Additionally, there are two partitions for *code* with different services versions. This way, the version of the code can be switched very quickly, just by rebooting the system. The *data* partition will be the same for both versions of the *code*, and it will always be mounted and ready to be used before the services start.

New partition layout:

NAME	MAJ:MIN	RM	SIZE	RO	TYPE	MOUNTPOINT	
sda	8:0	0	xG	0	disk		# Your disk with size X Gb
-sda1	8:1	0	1M	0	part		# BIOS legacy boot
-sda2	8:2	0	486M	0	part	/boot/efi	# UEFI boot
`-sda3	8:3	0	yG	0	part		# LVM partition
`-md0	9:0	0	yG	0	raid1		# SW RAID (if requested)
-ngcp-root	253:0	0	10G	0	lvm	/	# 'code' partition
-ngcp-fallback	253:1	0	10G	0	lvm		# 'fallback' partition
`-ngcp-data	253:3	0	zG	0	lvm	/ngcp-data	# 'data' partition
							# unassigned space

- 1st partition: 1M BIOS boot, for BIOS/GPT (legacy) boot
 - this allows fallback to grub-pc package (This partition must have its GUID set to 21686148-6449-6E6F-744E-656564454649 To switch to grub-pc, boot from a rescue/live CD, set to bios_grub with parted, then install grub to disk, so it properly embeds core.img)
- 2nd partition: ~500MB EFI System, for UEFI/GPT boot
 - used as /boot/efi, if EFI support is available
- 3rd partition: LVM that is divided into:
 - /dev/mapper/ngcp-root with 10GB (rootfs target)
 - /dev/mapper/ngcp-fallback with 10GB (for rollback/install/upgrade)
 - 10% or >=500MB (whichever is bigger) of the remaining space is unassigned to allow LVM snapshots during maintenance
 - /dev/mapper/ngcp-data is the **/ngcp-data** partition with the rest of the disk space for the whole platform *data* (e.g., databases, CDR files, logs, etc.)

Note

The installer can only boot from GPT and does not support ms-dos partitions anymore. The legacy *BIOS* systems can also boot from GPT, while (U)EFI systems can only boot from GPT (and not from BIOS/legacy boot).

G.4 UEFI

UEFI installation is supported. The dedicated UEFI partition has been created on the disk during the installation (being the second partition in the list).

G.5 Swap partition vs. file



Important

The Sipwise C5 performance heavily depends on the IO operations, hence if Swap is used (either the Swap file and/or the Swap partition), the performance might deteriorate. We highly recommend increasing RAM if the platform uses Swap during normal operation.

The Swap partition is no longer in use. The Sipwise C5 has been migrated to the Swap file on the *data* partition. It gives the following benefits:

- more space is now available for the *root*, *rollback* and *data* partitions.
- the Swap file size can be easily changed on the fly (if necessary).
- the Swap file can be migrated to a new location easily: create a new Swap file with the necessary size and location using the *mkswap* command and activate the new Swap file with *swapon*. Add the new location to */etc/fstab*. Now, you can deactivate the old swapfile with *swapoff* and remove it to release the disk space.

- The main reason for the Swap partition usage, used to be *data fragmentation* on hard disk drives (HDDs) and old types of filesystems. For modern SSD drives, the fragmentation issue is irrelevant and the *ext4* filesystem does not require manual defragmentation either. The free space on fast SSDs is more important nowadays, as it allows storing more *data*.

H Storage Node

H.1 Overview

Storage is an optional feature that enables one or more pairs of *storage* nodes that are especially configured for intense DB writing and storing data.

On the *storage* nodes MariaDB comes with dedicated configuration tuned for extensive writing. Currently *storage* nodes can be used to redirect and store *voisniff* traffic from the PRO nodes or the CARRIER *db* nodes.

From the running processes perspective on the *storage* nodes there is only MariaDB running (as well as usual mandatory processes like *rsyslog*, *systemd-timesyncd*, *ssh* and alike).

H.2 Deployment

storage nodes are not part of the default deployment and must be deployed manually using the NGCP deployment procedure.

Nodes must be deployed with type **stor**.

Default and internal names are:

- stor01 (vip)
- stor01a
- stor01b

Multiple *storage* pairs are supported (*stor02*, *stor03*).

H.3 Configuration

Once deployed you can move *stor_int* type in the network.yml to the interface where the traffic is expected on. It is a good practice to have a dedicated interface for that so that it is separated with SIP/RTP/HA traffic.

I NGCP Internals

This chapter documents internals of Sipwise C5 that should not be usually needed, but might be helpful to understand the overall system.

I.1 Pending reboot marker

The Sipwise C5 has the ability to mark a pending reboot for any server, using the file `/run/reboot-required`. As soon as the file exists, several components will report about a pending reboot to the end-user. The following components report about a pending reboot right now: `ngcp-status`, `ngcpcfg status`, `motd`, `ngcp-upgrade`. Also, `ngcp-upgrade` will NOT allow proceeding with an upgrade if it notices a pending reboot. It might affect `rtengine` dkms module building if there is a pending reboot requested by a newly installed kernel, etc.

I.2 Redis id constants

The list of current Sipwise C5 Redis DB IDs:

Service	central (role db)	local	Release	Ticket	Description
sems	-	0	mr3.7.1+	-	HA switchover
rtengine	-	1	mr3.7.1+	-	HA switchover
proxy	2	-	mr3.7.1+	-	Counter of hunting groups
proxy	3	-	mr3.7.1+	-	Concurrent dialog counters
proxy	-	4	mr3.7.1+	-	List of keys of the central counters
prosody	5	-	mr3.7.1+	-	XMPP cluster
sems PBX	-	6	mr3.7.1+	-	HA switchover
sems	7	-	mr4.1.1+	MT#12707	Sems malicious_call app
captagent	-	8	mr4.1.1+ - mr7.1	MT#15427	Old captagent internal data (unused)
monitoring	9	-	mr4.3+ - mr5.5	MT#31	Old SNMP agent monitoring data (unused)
proxy	10	-	mr4.3+	MT#16079	SIP Loop detection
ngcp-panel sessions	-	19	mr6.3+	TT#35523	Panel login sessions
proxy usrloc	20	-	mr6.2+	TT#32971	SIP registrations

Service	central (role db)	local	Release	Ticket	Description
proxy acc	-	21	mr6.2+	TT#32971	Accounting records
proxy auth	-	22	mr6.2+	TT#32971	Subscriber data
proxy dialog	-	23	mr6.2+	TT#34100	Dialog data
lb topos	-	24	mr6.5+	TT#40617	Topos data
proxy pbx	25	-	mr8.0+	TT#64404	PBX in use by each subscriber
proxy 181 HIH	26	-	mr8.5+	TT#89301	HIH stored for 181 messages
websocket	-	30	mr7.1+	TT#49703	Internal data
websocket monitors	-	31	mr7.1+	TT#49703	Monitors
websocket subscriptions	-	32	mr7.1+	TT#49703	Subscriptions

I.3 InfluxDB monitoring keys

The *InfluxDB ngcp* monitoring database contains time series of several monitoring sources. The following are some of the current measurements:

node	Cluster node information.
memory	System memory information.
proc_count	Process counts.
monit	Monit supervised processes information.
mail	MTA information.
mysql	MySQL database information.
kamailio	Kamailio statistics information.
sip	SIP statistics information.

The *node* measurement contains the following fields:

active	Cluster node HA state (boolean: 1/0).
hb_proc_state	Cluster node GCS/CRM process state (boolean: stopped/running).
hb_host_state	Cluster node host state (boolean: up/down).
hb_node_state	Cluster node HA state (ngcp-check-active -p).

The *monit* measurement contains the following fields:

name	The process name.
proc_status	The process status.
monit_status	The monit status.

pid	The process ID.
ppid	The process parent ID.
children	The number of children.
uptime	The process uptime.
cpu_percent	The CPU usage in percent for this process.
cpu_percent_total	The CPU usage in percent for the process group.
memory	The memory in bytes for this process.
memory_total	The memory in bytes for the process group.
memory_percent	The memory in percent for this process.
memory_percent_total	The memory in percent for the process group.
data_collected	The timestamp when the data was collected.

The *mysql* measurement contains the following fields:

last_io_error	Last IO error description.
last_sql_error	Last SQL error description.
queries_per_second_average	Average of queries per second.
replication_discrepancies	Number of replication discrepancies.

I.4 Preferences

I.4.1 Tables

Currently available tables for preferences are

`provisioning.voip_preferences`: contains all available preferences, do not contain user data. `provisioning.voip_preferences_group_names`: contains preference group names, so the preferences can be put into groups. `provisioning.voip_preferences_enum`: contains enum values for preferences, do not contain user data.

The following tables contain user data and depend on `voip_preferences` and optionally on `voip_preferences_enum`:

`provisioning.voip_dev_preferences`: PBX device model preferences `provisioning.voip_devprof_preferences`: PBX device profile preferences `provisioning.voip_dom_preferences`: domain preferences, replicated by triggers to `kamailio.dom_preferences` `provisioning.voip_contract_preferences`: customer preferences, replicated by triggers to `kamailio.contract_preferences` `provisioning.voip_peer_preferences`: peering server preferences, replicated by triggers to `kamailio.peer_preferences` `provisioning.voip_prof_preferences`: subscriber profile preferences `provisioning.voip_reseller_preferences`: reseller preferences `provisioning.voip_usr_preferences`: subscriber preferences, replicated by triggers to `kamailio.usr_preferences`

I.4.2 Columns

voip_preferences id: primary key, used in user tables as the foreign key `voip_preference_groups_id`: preference group id attribute: preference name label: tooltip that can be used as a mouseover tooltip on the UI type: 0 - *string*, 1 - *integer/boolean* max_occur: how many preferences with the name are allowed 0: list, 1: only one `usr_pref`: de-

fines if the preference can be used in subscribers `prof_pref`: defines if the preference can be used in subscriber profiles
`dom_pref`: defines if the preference can be used in domains `peer_pref`: defines if the preference can be used in peer-
 ing servers `contract_pref`: defines if the preference can be used in customers `contract_location_pref`: defines
 if the preference can be used in customer locations `dev_pref`: defines if the preference can be used in PBX device models
`devprof_pref`: defines if the preference can be used in PBX device profiles `fielddev_pref`: defines if the preference can
 be used in PBX devices that are assigned to a subscriber `modify_timestamp`: preference last modification time `internal`:
 preference if for internal use only and not shown in the UI/API `expose_to_customer`: unused, as now there are dedicated
 customer preferences table `data_type`: data type *enum, boolean, int, string* `read_only`: ready only flag `description`:
 long description of the preference `dynamic`: set to 1 if it is a custom preference that is created by a user (usually for a PBX
 device model that requires specific preferences) but can be used for all preferences when needed `reseller_pref`: defines if
 the preference can be used in resellers

I.4.3 Enum

All tables are in database "provisioning".

So called "enum preferences" allow a fixed set of possible values, an enumeration, for preferences. Following the differences between other preferences are described.

Setting the attribute "data_type" of table "voip_preferences" to "enum" marks a preferences as an enum. The list of possible options is stored in table "voip_preferences_enum".

voip_preferences_enum is:

```
id
  primary key
```

```
preference_id
  Reference to table voip_preferences.
```

```
label
  A label to be displayed in frontends.
```

```
value
  Value that will be written to voip_[usr|dom|peer]_preferences.value
  if it is NOT NULL. Will not be written if it IS NULL. This can be
  used to implement a "default value" for a preference that is visible
  in frontends as such (will be listed first if nothing is actually
  selected), but will not be written to
```

voip_[usr|dom|peer]_preferences.value. Usually forcing a domain or peer default. Should also be named clearly (eg. ___"use domain default"___).
(Note: Therefore will also not be written to any kamailio table.)

usr_pref

dom_pref

peer_pref

Flag if this is to be used for [usr|dom|peer] preferences.

default_val

Flag indicating if this should be used as a default value when creating new entities or introducing new enum preferences (both done via triggers). (Note: For this to work, value must also be set.)

Relevant triggers:

enum_update

Propagates changes of voip_preferences_enum.value to voip_[usr|dom|peer]_preferences.value

enum_set_default

Will create entries for default values when adding a new enum preference. The default value is the tuple from voip_preferences_enum WHERE default_val=1 AND value NOT NULL.

trigger voip_dom_crepl_trig

trigger voip_phost_crepl_trig

trigger voip_sub_crepl_trig

These three triggers will set possible default values (same condition as for enum_set_default) when creating new subscribers/domains/peers.

Find a usage example in a section in *db-schema/db_scripts/diff/9086.up*.

J Kamilio pv_headers module

This chapter documents the new kamilio "pv_headers" modules introduced in Sipwise C5 starting from version mr7.0.1.

J.1 Module overview

This new module enables storing all headers in XAVP to freely modify them in the kamilio logic and only apply them once when it's time for the packet to be routed outside. The main goal of the module is to offload the intermediate header processing into the XAVP dynamic container as well as provide with high level methods and pseudovariables to simplify SIP message header modifications.

In few words:

- as soon as a SIP message enters the proxy, kamilio reads all the headers (using the function "pv_collect_headers()") and stores them in an XAVP called "headers".
- starting from this point all the header changes are directly performed on the "headers" XAVP. For example the From header is available at `$xavp(headers[0]⇒From[0])`.
- right before the SIP message leaves the proxy, kamilio writes back all the headers changes (using the function "pv_apply_headers()").

RURI and the headers listed in the module parameter "skip_headers" are left untouched and not saved in the XAVP. Therefore they should be handled in the usual way.

J.2 Template changes

As described before in the upgrade procedures, the module is enabled by default in kamilio proxy and all the templates have been already updated to use this new logic. Before proceeding with the upgrade, it is essential that the customtt/patchtt files you have in place are updated to this new format.

Here just some few examples of what has been changed in the proxy templates:

- variables \$fu, \$fU, \$fd, \$fn, \$ft have been substituted by \$x_fu, \$x_fU, \$x_fd, \$x_fn, \$x_ft
- variables \$tu, \$tU, \$td, \$tn, \$tt have been substituted by \$x_tu, \$x_tU, \$x_td, \$x_tn, \$x_tt
- variables \$rr, \$rs have been substituted by \$x_rr, \$x_rs
- variables \$ua have been substituted by \$x_hdr(User-Agent)
- variables \$ai have been substituted by \$x_hdr(P-Asserted-Identity)
- variables \$pU, \$pd have been substituted by \$x_hdr(P-Preferred-Identity)
- variables \$re have been substituted by \$x_hdr(Remote-Party-ID)
- variables \$di have been substituted by \$x_hdr(Diversion)

- variables `$ct` have been substituted by `$x_hdr(Contact)`
- `$hdr("name")` has been substituted by `$x_hdr("name")`
- `is_present_hf("name")` has been substituted by `$x_hdr(name)!= $null`
- `remove_hf("name")` has been substituted by `pv_remove_header("name")` function or `$(x_hdr(name)[*]) = $null`
- `append_hf("name: value\r\n")` has been substituted by `pv_append_header("name", "value") / pv_modify_header("name", "value")` functions or `$(x_hdr(name)[*]) = value`
- `t_check_status(code)` has been substituted by `$T_reply_code == code`
- `save("location")` has been updated in `save("location", "0x00", "$x_tu")`
- `sd_lookup("speed_dial")` has been updated in `sd_lookup("speed_dial", $x_fu)`
- added `pv_collect_headers()` and `pv_reset_headers()` functions in the dedicated `ROUTE_COLLECT_HDR` route
- added `pv_apply_headers()` function in the dedicated `ROUTE_APPLY_HDR` route
- added `pv_reset_headers()` function in the following routing sections

J.3 Module documentation

J.3.1 Parameters

xavp_name (string)

Name of the XAVP where the collected headers are stored.

Default: headers

```
modparam("pv_headers", "xavp_name", "headers")
```

Result:

```
$xavp(headers[0]=>From)
$xavp(headers[0]=>To)
$xavp(headers[0]=>Call-ID)
....
```

skip_headers (string)

A comma separated headers list that must be excluded from processing (they are skipped when `pv_apply_headers()` changes the sip message headers). If the parameter is not set then the "Default" list is used. If the parameter is set to an empty string then all the sip message headers are processed.

Default: Record-Route,Via,Route,Content-Length,Max-Forwards

split_headers (string)

A comma separated headers list that must be split into multi headers if their value is a comma separated list. If the parameter is not set then the "Default" is used. If the parameter is set to an empty string then no headers are split.

Default: None

```
modparam("pv_headers", "split_headers", "Diversion")
```

Result:

Received Diversion header:

```
Diversion: <user1@test.local>,<user2@test.local>,<user3@test.local>
```

After split:

```
Diversion: <user1@test.local>
```

```
Diversion: <user2@test.local>
```

```
Diversion: <user3@test.local>
```

Becomes handy `if` used together with `pv_modify_header()` or `pv_remove_header()` to change or remove value 2 `for` instance.

J.3.2 Functions

`pv_collect_headers()`

This function collects all headers from the message into the XAVP. It should be used preferably just when the sip message is received by kamailio.

Returns:

- 1 - on success
- -1 - if there were errors

`pv_apply_headers()`

This function applies the current XAVP headers state to the real headers and should be called only once per branch when the message is about to leave kamailio.

The following rules apply:

- all headers in the XAVP except for ones provided in the "skip_headers" parameter and From/To are recreated in the sip message.
- From/To headers are processed by the uac module if it is loaded.
- From/To headers are not changed in the reply messages.
- headers with NULL value are removed if exist in the sip message.
- the initial order of the sip headers is preserved.

Usage:

```
if (pv_apply_headers ())
{
    "success"
}
else
{
    "errors"
}
```

pv_reset_headers()

This function resets the current XAVP headers list and enables `pv_collect_headers()` and `pv_apply_headers()` to be called again in the same branch.

Usage:

```
if (pv_reset_headers ())
{
    "success"
}
else
{
    "errors"
}
```

pv_check_header(hname)

This function checks if the header already exists in the XAVP. It can be freely called from anywhere, but only after `pv_collect_headers()`.

Usage:

```
if (pv_check_header (hname) )
{
    "exists"
}
else
{
    "does not exist"
}
```

pv_append_header(hname, hvalue)

This function appends a new header into the XAVP. It can be freely called from anywhere, but only after `pv_collect_headers()`.

Please note that subsequent "pv_append_header" calls will result in multiple headers. If the provided "hvalue" is \$null then the header is added into the XAVP but it is not going to be added into the message.

Usage:

```
if (pv_append_header(hname, hvalue))
{
    "appended"
}
else
{
    "errors"
}
```

pv_modify_header(hname, hvalue)

This function modifies an existing header in the XAVP. It can be freely called from anywhere, but only after pv_collect_headers(). Please note that if the header does not exist it will be explicitly appended. If there are multiple headers with the same name only the first one will be affected. If the provided header value is \$null then the header is modified in the XAVP then it is removed from the sip message when pv_apply_headers() is called.

Usage:

```
if (pv_modify_header(hname, hvalue))
{
    "modified"
}
else
{
    "errors"
}
```

pv_modify_header(hname, idx, hvalue)

This function works similar to pv_modify_header(hname, hvalue) but should be used when there are multiple headers with the same name one of them to be modified. Index order is top to bottom.

Usage:

```
if (pv_modify_header(hname, idx, hvalue))
{
    "modified"
}
else
{
```

```
"errors"
}
```

pv_remove_header(hname)

This function removes an existing header from the XAVP. It can be freely called from anywhere, but only after `pv_collect_headers()`. If there are multiple headers with the same name all of them are removed. It returns -1 if the header does not exist.

Usage:

```
if (pv_remove_header(hname, hvalue))
{
    "removed"
}
else
{
    "does not exist or errors"
}
```

pv_remove_header(hname, idx, hvalue)

This function works similar to `pv_remove_header(hname, hvalue)` but should be used when there are multiple headers with the same name one of them to be removed. Index order is top to bottom.

Usage:

```
if (pv_remove_header(hname, idx, hvalue))
{
    "removed"
}
else
{
    "does not exist or errors"
}
```

J.3.3 Pseudovariables

\$x_hdr

This pseudovariable is used to append/modify/remove headers by their name and can be used instead of the `pv_append_header()`, `pv_modify_header()`, `pv_remove_header()` functions.

Usage:

- append header "X-Header" with value "example". NOTE: It always appends a header, even there is already one with the same

name

```
$x_hdr(X-Header) = "example";
```

- modify header "X-Header" with index 0. Returns an error if there is no such index

```
$(x_hdr(X-Header)[0]) = "example";
```

- remove all occurrences of header "X-Header" and append one with value "example"

```
$(x_hdr(X-Header)[*]) = "example";
```

- remove header "X-Header" with index 2 (if there are multiple headers). Returns an error if there is no such index

```
$(x_hdr(X-Header)[2]) = $null;
```

- remove all occurrences of the header. Does not produce an error if there is no such header

```
$(x_hdr(X-Header)[*]) = $null;
```

- retrieve a value of header "X-Header" with index 0, otherwise \$null

```
$var(test) = $x_hdr(X-Header);
```

- retrieve a value of header "X-Header" with index 0 otherwise \$null

```
$var(test) = $x_hdr(X-Header)[*];
```

- retrieve a value of header "X-Header" with index 2 otherwise \$null

```
$var(test) = $(x_hdr(X-Header)[2]);
```

\$x_fu, \$x_tu

These pseudovariabes are used to modify/retrieve the "From" and "To" headers.

Usage:

- modify the header

```
$x_fu = "User1 <440001@example.local>";
```

- retrieve a value of the header

```
$var(test) = $x_fu;
```

- \$x_tu usage is the same

\$x_fU, \$x_tU

These pseudovariabes are used to modify/retrieve the username part of the "From" and "To" headers.

Usage:

- modify the username part

```
$x_fU = "440001";
```

- retrieve the username part

```
$var(test) = $x_fU;
```

- \$x_tU usage is the same

\$x_fd, \$x_td

These pseudovariabes are used to modify/retrieve the domain part of the "From" and "To" headers.

Usage:

- modify the domain part

```
$x_fd = "example.local";
```

- retrieve the domain part

```
$var(test) = $x_fd;
```

- \$x_td usage is the same

\$x_fn, \$x_tn

These pseudovariabes are used to modify/retrieve the display part of the "From" and "To" headers.

Usage:

- modify the username part

```
$x_fn = "User1";
```

- retrieve the domain part

```
$var(test) = $x_fn;
```

- \$x_tn usage is the same

\$x_ft, \$x_tt

These pseudovariabes are used to retrieve the tag part of the "From" and "To" headers.

Usage:

- retrieve the tag part

```
$var(test) = $x_ft;
```

- \$x_tt usage is the same

\$x_rs, \$x_rr

These pseudovariabes are used to modify/retrieve or change "status" and "code" of the SIP reply NOTE: Only messages with reply status > 300 can be changed as well as reply status 1xx and 2xx cannot be set

Usage:

- modify the reply status

```
$x_rs = 486
```

- retrieve the reply status

```
$var(test) = $x_rs;
```

- modify the reply reason

```
$x_rr = "Custom Reason"
```

- retrieve the reply reason

```
$var(test) = $x_rr;
```

K Extra Configuration Scenarios

K.1 AudioCodes devices workaround

Old AudioCodes devices suffer from a problem where they replace 127.0.0.1 address in Record-Route headers (added by Sipwise C5's internal components) with the device's IP address. Supposedly, the whole range of AudioCodes devices with a firmware version below 6.8.X are affected. As a workaround, you may enable the topos feature to stop sending Record-Route headers out. To achieve this, execute the following commands:

```
ngcpcfg set /etc/ngcp-config/config.yml kamailio.lb.security.topos.enable=yes
ngcpcfg apply 'enable topos for audiocodes devs workaround'
```

K.2 "Debug Proxy" for troubleshooting



Important

This functionality only makes sense on Sipwise C5 CARRIER appliance environment that has an inactive proxy node available.

In order to troubleshoot/debug/capture a scenario, the "debug proxy" allows defining a list of "debug subscribers" that will be matched against From/To headers for every SIP message on a specific lb node. If matched that SIP message will be delivered to the assigned proxy node. In summary, any call to/from that subscriber will be easily traced since no calls are delivered by default to an inactive "debug proxy" node. Also, you can enable extra debug levels on the "debug proxy" node which will NOT affect production traffic on the platform.



Important

The subscribers have to be specified in the same format as they are received on Kamailio LB (before all the rewrite rules applied).



Important

In the following examples both proxy node *prx99a* and *prx99b* must be set to **inactive** nodes *hosts.prx99a.status=inactive* and *hosts.prx99b.status=inactive* in *network.yml*!

To enable the feature for INACTIVE *prx99* proxy pair, execute:

```
ngcpcfg set /etc/ngcp-config/network.yml hosts.prx99a.status=inactive # for the safety
ngcpcfg set /etc/ngcp-config/network.yml hosts.prx99b.status=inactive # for the safety
```

```
ngcpcfg set /etc/ngcp-config/config.yml kamailio.lb.debug_uri.enable=yes
ngcpcfg apply 'Enable debug proxy on node prx99'
ngcpcfg push-parallel all
```

And make sure *prx99* active node has this new config applied.

There's a command-line tool available to manage the subscriber list. An example of use:

```
ngcp-debug-subscriber add lb01 +4310001000@example.org sipuser@example.org prx99
ngcp-debug-subscriber delete lb01 +4310001000@example.org
ngcp-debug-subscriber list lb01
```

Be aware that the list of debug subscribers belongs to just one lb pair, the info is kept in REDIS *local* database, it is necessary to survive LB restarts and/or HA switchovers. To skip saving in REDIS *local* database, specifying the option `--no-store` (in this case the information will stay in memory only and will be void on Kamailio LB restart):

```
ngcp-debug-subscriber add --no-store lb01 +10001042@example.org prx99
```

See more available options in general and per-action help messages:

```
ngcp-debug-subscriber --help
ngcp-debug-subscriber add --help
```



Warning

It is recommended to keep the amount of "debug subscribers" as small as possible (for performance reasons).

The "debug subscribers" is kept in a kamailio htable. htable index size value can be changed if necessary in config.yml using the option `kamailio.lb.debug_uri.htable_idx_size`. This is **not** the maximum size. From Kamailio htable documentation:

```
size - number to control how many slots (buckets) to create for the hash table.
A larger value means more slots with a higher probability for fewer collisions.
The actual number of slots (or buckets) created for the table is 2^size.
The possible range for this value is from 2 to 31, smaller or larger values
will be increased to 3 (8 slots) or decreased to 14 (16384 slots).
Note that each slot can store more than one item, when there are collisions of
hash ids computed for keys. The items in the same slot are stored in a linked list.
In other words, the size is not setting a limit of how many items can be
stored in a hash table, as long as there is enough free shared memory,
new items can be added.
```

The default value *kamailio.lb.debug_uri.htable_idx_size=4* is enough for all the use cases in production.