



Sipwise NGCP Operations Manual  
PRO/CARRIER

Sipwise GmbH <[support@sipwise.com](mailto:support@sipwise.com)>

# Table of Contents

1. Introduction	1
1.1. About this Handbook	1
1.2. What is the Sipwise C5 PRO/CARRIER?	1
1.3. The Advantages of the Sipwise C5 PRO/CARRIER	1
1.4. Who is the Sipwise C5 PRO/CARRIER for?	2
1.5. Getting Help	2
2. Architecture	3
2.1. Platforms	3
2.2. Provisioning	4
2.3. API and Web Interface	4
2.4. SIP Signaling and Media Relay	5
2.5. MySQL Database	11
2.6. Redis Database	12
2.7. High Availability and Fail-Over	13
2.8. Scaling CARRIER beyond one Hardware Chassis	14
2.9. Scaling to a Multi-Site Geo-Redundant setup	15
3. Deployment	18
3.1. Installation Prerequisites	18
3.2. Installation CARRIER	22
3.3. Installation Pro	25
3.4. What's happening when booting the Sipwise Deployment ISO	35
4. Concept	39
4.1. Contacts	39
4.2. Resellers	39
4.3. SIP Domain	40
4.4. Contracts	40
4.5. Customers	41
4.6. Subscribers	43
4.7. SIP Peerings	44
5. Kick-off	46
5.1. Creating a SIP Domain	46
5.2. Creating a Customer	47
5.3. Creating a Subscriber	51
5.4. Domain Preferences	54
5.5. Subscriber Preferences	57
5.6. Creating Peerings	59
5.7. Configuring Rewrite Rule Sets	74
6. Billing	91
6.1. Billing Profiles	91
6.2. Peak Time Call Rating Modes	97
6.3. Prepaid Accounting	98

6.4. Fraud Detection and Locking .....	98
6.5. Billing Customizations .....	100
6.6. Notes on Billing and Call Rating .....	127
6.7. Billing Data Export to Files .....	127
6.8. Billing Data Replication to Remote Databases .....	144
7. Features .....	153
7.1. About the Admin Web Interface .....	153
7.2. Managing System Administrators .....	154
7.3. Access Control for SIP Calls .....	158
7.4. Call Forwarding and Call Hunting .....	173
7.5. Call Forking by Q value .....	183
7.6. Local Number Porting .....	185
7.7. P-Early-Media .....	202
7.8. Emergency Mapping .....	203
7.9. Emergency Priorization .....	210
7.10. Speed dials .....	216
7.11. SIP Message Filtering .....	218
7.12. SIP Trunking with SIPconnect .....	223
7.13. Trusted Subscribers .....	230
7.14. Peer Probing .....	231
7.15. Fax Server .....	235
7.16. Voicemail System .....	237
7.17. Configuring Subscriber IVR Language .....	244
7.18. Sound Sets .....	246
7.19. Conference System .....	253
7.20. Malicious Call Identification (MCID) .....	258
7.21. Subscriber Profiles .....	260
7.22. SIP Loop Detection .....	261
7.23. Call-Through Application .....	261
7.24. Calling Card Application .....	265
7.25. Invoices and Invoice Templates .....	268
7.26. Email Reports and Notifications .....	281
7.27. Calling Line Identification Restriction .....	286
7.28. Connected Line Identification Restriction .....	286
7.29. Do not Disturb .....	287
7.30. The Vertical Service Code Interface .....	288
7.31. Call Recording .....	293
7.32. Media Transcoding and Transrating .....	303
7.33. Transcription Services .....	309
7.34. Announcement Before Call Setup .....	313
7.35. Emulated Ringback Tone .....	314
7.36. Store Recent Calls and Redial .....	315
7.37. Time sets management .....	317

7.38. Announcement To Callee	324
7.39. Header Manipulations	325
7.40. Phonebook	333
7.41. Subscriber Location Mappings	337
7.42. STIR/SHAKEN	343
7.43. Fileshare	348
7.44. Batch Provisioning	355
7.45. Call List Suppressions	376
7.46. Message Body Filtering	379
7.47. Generation of 181 Call Is Being Forwarded	380
8. Extra Modules	381
8.1. Cloud PBX	381
8.2. Sipwise sip:phone App (SIP client)	488
8.3. Lawful Interception	508
8.4. 3PCC functionality (TPCC), CSTA sessions and Websocket component	534
8.5. Phone Voice Quality Reporting	554
8.6. SMS (Short Message Service) on Sipwise C5	556
9. Configuration Framework	569
9.1. Configuration templates	569
9.2. config.yml, constants.yml and network.yml files	574
9.3. ngcpcfg and its command line options	574
10. Network Configuration	578
10.1. General Structure	578
10.2. Advanced Network Configuration	582
11. Software Upgrade	592
11.1. Release Notes	592
11.2. Overview	592
11.3. Planning a software upgrade	593
11.4. Pre-upgrade checks	594
11.5. Pre-upgrade steps	599
11.6. Upgrading Sipwise C5 CARRIER	601
11.7. Upgrading Sipwise C5 PRO	604
11.8. Post-upgrade steps	607
11.9. Applying the Latest Hotfixes	608
12. Backup, Recovery and Maintenance	612
12.1. Sipwise C5 Backup	612
12.2. Recovery	613
12.3. Reset Database	613
12.4. Synchronize database	613
12.5. Accounting Data (CDR) Cleanup	615
12.6. Managing packages	620
13. Security, Performance and Troubleshooting	626
13.1. Sipwise SSH access to Sipwise C5	626

13.2. Firewalling	627
13.3. Password management	635
13.4. UI/API security	636
13.5. Managing POSIX users	637
13.6. LDAP authentication for POSIX users	638
13.7. Remote 'root' logins via SSH	638
13.8. 'sudo-io': logging input/output of commands run through 'sudo'	639
13.9. SSL certificates	640
13.10. Securing your Sipwise C5 against SIP attacks	641
13.11. Topology Hiding	643
13.12. System Requirements and Performance	646
13.13. Troubleshooting	648
13.14. Log file obfuscation	653
14. Monitoring and Alerting	656
14.1. Internal Monitoring	656
14.2. Statistics Dashboard	657
14.3. External Monitoring Using SNMP	658
15. Licenses	664
15.1. What is Subject to Licensing?	664
15.2. How Licensing Works	665
15.3. How to Configure Licenses	665
15.4. How to Monitor License Client	666
16. Customer Self-Care	667
16.1. Customer Self-Care User Interface (CSC UI)	667
16.2. The Customer Self-Care Web Interface	667
16.3. The Voicemail Menu	671
16.4. Company Hours	671
17. REST API	673
17.1. API Workflows for Customer and Subscriber Management	673
17.2. API performance considerations	678
Appendix	679
Appendix A: Corosync/Pacemaker	680
Appendix B: OpenVPN Setup	691
Appendix C: Basic Call Flows	695
Appendix D: Configuration Overview	701
Appendix E: Sipwise C5 Authentication Tokens	763
Appendix F: MariaDB encryption	767
Appendix G: Disk partitioning	769
Appendix H: Faxserver Configuration	771
Appendix I: Storage Node	782
Appendix J: NGCP Internals	783
Appendix K: Kamailio pv_headers module	793
Appendix L: Extra Configuration Scenarios	802

Appendix M: NGCP CLI helpers and tools .....	804
Appendix N: Handling WebRTC Clients .....	811
Appendix O: Batch Provisioning Extras .....	812
Appendix P: CSTA .....	820
Appendix Q: Fritzbox prefix removal on Sipwise C5 .....	830
Appendix R: Migration from KeyDB to Valkey .....	832

# Chapter 1. Introduction

## 1.1. About this Handbook

This handbook describes the architecture and the operational steps to install, operate and modify the Sipwise C5 PRO/CARRIER.

In various chapters, it describes the system architecture, the installation and upgrade procedures and the initial configuration steps to get your first users online. It then dives into advanced preference configurations such as rewrite rules, call blocking, call forwarding, etc.

There is a description of the customer self-care interface, how to configure the billing system and how to provision the system via the API.

Finally, it describes the internal configuration framework, the network configuration and gives hints about tweaking the system for better security and performance.

## 1.2. What is the Sipwise C5 PRO/CARRIER?

Sipwise C5 (also known as NGCP - the Next Generation Communication Platform) is a SIP-based Open Source Class 5 VoIP soft-switch platform that allows you to provide rich telephony services. It offers a wide range of features (e.g. call forwarding, voicemail, conferencing etc.) that can be configured by end users in the self-care web interface. For operators, it offers a web-based administrative panel that allows them to configure subscribers, SIP peerings, billing profiles, and other entities. The administrative web panel also shows the real-time statistics for the whole system. For tight integration into existing infrastructures, Sipwise C5 provides a powerful REST API interface.

Sipwise C5 has three solutions that differ in call capacity and service redundancy: CARRIER, PRO and CE. The current handbook describes the PRO/CARRIER solution.

The Sipwise C5 CARRIER comes pre-installed on six or more servers in one or more Lenovo Flex System Enterprise Chassis, see [Architecture](#). Apart from your product specific configuration, there is no initial configuration or installation to be done to get started.

The Sipwise C5 PRO can be pre-installed on two hardware servers or deployed in a customer virtual environment. Apart from your product specific configuration, there is no initial configuration or installation to be done to get started.

## 1.3. The Advantages of the Sipwise C5 PRO/CARRIER

Opposed to free VoIP software, Sipwise C5 is not a single application, but a complete software platform based on Debian GNU/Linux.

Using a highly modular design approach, Sipwise C5 leverages popular open-source software like MySQL, NGINX, Kamailio, SEMS, Asterisk, etc. as its core building blocks. These blocks are glued together using optimized and proven configurations and workflows and are complemented by functionality developed by Sipwise to provide fully-featured and easy-to-operate VoIP services.

The installed applications are managed by the Sipwise C5 Configuration Framework. This configuration framework makes it possible to change low-level system parameters in a single place, so Sipwise C5

administrators don't need to have any knowledge of dozens of different configuration files from different packages. This provides a bullet-proof way of operating, changing and tweaking an otherwise quite complex system.

Once configured, integrated web interfaces are provided for both end users and Sipwise C5 administrators. Provisioning and billing API allows companies to tightly integrate Sipwise C5 into existing OSS/BSS infrastructures to optimize workflows.

## 1.4. Who is the Sipwise C5 PRO/CARRIER for?

The Sipwise C5 PRO/CARRIER are specifically tailored to companies who want to provide fully-featured SIP-based VoIP service without having to go through the steep learning curve of SIP signalling. It integrates the different building blocks to make them work together in a reasonable way. The Sipwise C5 PRO/CARRIER is already deployed all around the world by all kinds of VoIP operators, using it as Class5 soft-switch, as Class4 termination platform or even as Session Border Controller with all kinds of access networks, like Cable, DSL, WiFi and Mobile networks.

## 1.5. Getting Help

### 1.5.1. Phone Support

Depending on your support contract, you are eligible to contact our Support Team by phone either during business hours or around the clock. Business hours refer to the CET/CEST time zone (Europe/Vienna). Please check your support contract to find out the type of support you've purchased.

Before calling our Support Team, please also open a ticket in our Ticket System and provide as much detail as you can for us to understand the problems, fix them and investigate the cause. Please provide the number of your newly created ticket when asked by our support personnel on the phone.

You can find phone numbers, Ticket System URL, and account information in your support contract. Please make this information available to the persons in your company maintaining Sipwise C5.

### 1.5.2. Ticket System

Depending on your support contract, you can create either a limited or an unlimited amount of support tickets on our Web-based Ticket System. Please provide as much information as possible when opening a ticket, especially the following:

- **WHAT** is affected (e.g. the whole system is unreachable, or customers can't register or place calls)
- **WHO** is affected (e.g. all customers, only parts of it, and **WHICH** parts - only customers in a particular domain or customers with specific devices, etc.)
- **WHEN** did the problem occur (time frames, or after the firmware of specific devices types have been updated, etc.)

Our Support Team will ask further questions via the Ticket System along the way of troubleshooting your issue. Please provide the information as soon as possible to solve your issue promptly.

# Chapter 2. Architecture

## 2.1. Platforms

### 2.1.1. CARRIER Platform

The Sipwise C5 CARRIER platform is composed by a cluster of four different node types, which are all deployed in active/standby pairs:

- **Web-Servers** (web1a/web1b): Provide northbound interfaces (CSC, API) via HTTPS for provisioning
- **DB-Servers** (db1a/db1b): Provide the central persistent SQL data store for customer data, peering configuration, billing data etc.
- **Proxy-Servers** (proxy1a/proxy1b .. proxy4a/proxy4b): Provide the SIP signalling engines, application servers and media relays to route Calls and IM/Presence and serve media to the endpoints.
- **Load-Balancers** (lb1a/lb1b): Provide a perimeter for SIP signalling.

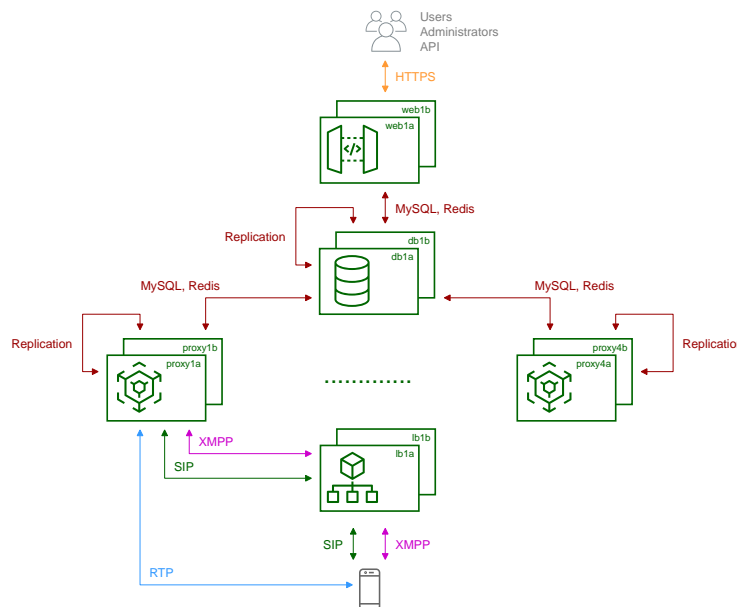

Figure 1. CARRIER Architecture Overview

The system is provisioned via the web servers on a central pair of db servers. Signalling is entering the system via the *lb* servers to a cluster of proxies, which in turn communicate directly (caching and shared data) and indirectly (static provisioning data replicated via master/slave) with the db servers. Each pair of proxy is capable of handling any subscriber, so subscribers are not bound to specific "home proxies". Once a call starts on a proxy pair, it is ensured that the full range of services is provided on that pair (voicemail, media, billing, ...) until call-teardown. Failures on an active *proxy* node cause a fail-over to the corresponding stand-by node within the *proxy* pair, taking over the full signalling and media without interruptions.

### 2.1.2. PRO Platform

The Sipwise C5 PRO platform consists of two identical appliances working in active/standby mode. The components of a node are outlined in the following figure:

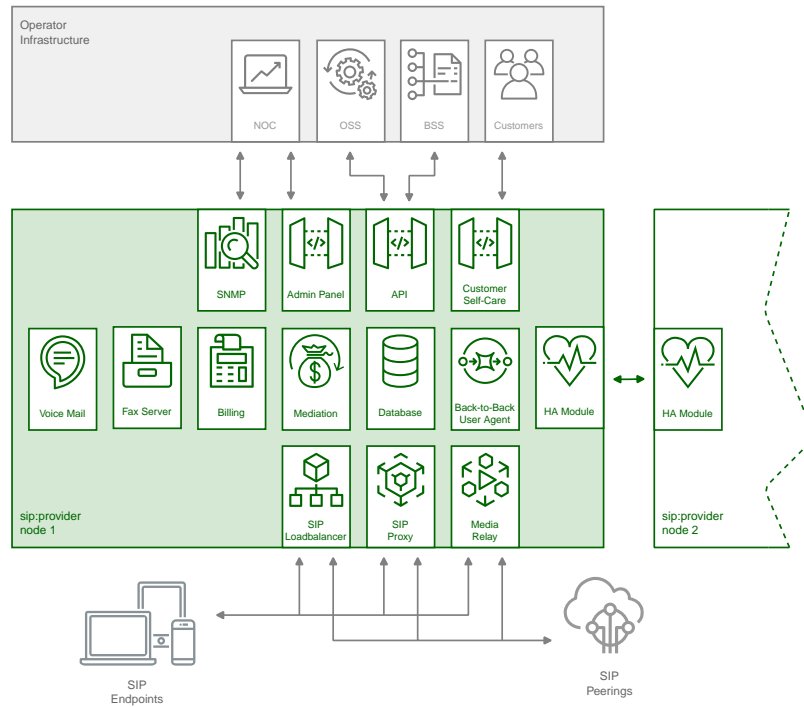

Figure 2. PRO Architecture Overview

The main building blocks of Sipwise C5 are:

- Provisioning
- SIP Signaling and Media Relay
- Mediation and Billing
- Monitoring and Alerting
- High Availability and Fail-Over

## 2.2. Provisioning

Any HTTPS traffic for provisioning (web interfaces, northbound APIs) but also for phone auto-provisioning enters the platform on the active web server. The web server runs an nginx instance acting as a reverse proxy for the ngcp-panel process, which in turn provides the provisioning functionality.

The web server is connected to the db server pair, which provides a persistent relational data store via MySQL and a high-performance system cache using Redis key-value store.

## 2.3. API and Web Interface

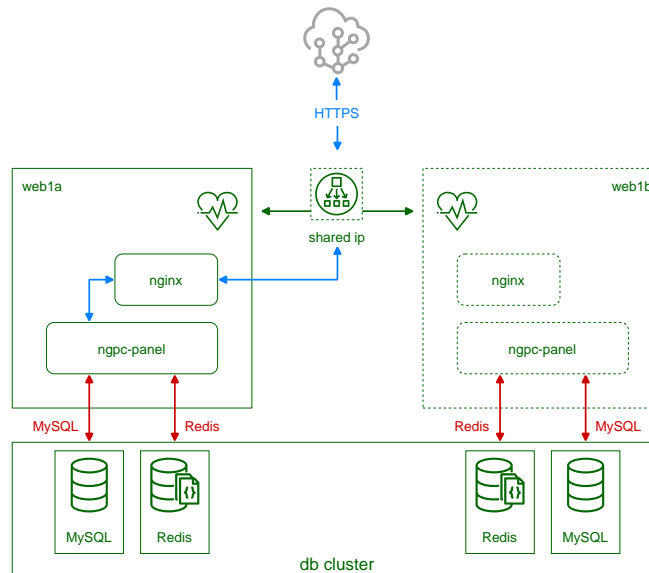

Figure 3. CARRIER Web Server Overview

The web server pair is an active/standby pair of nodes connected via an HA service (GCS/CRM). If one of the servers fail (by losing connection to the outside while the standby server is still connected, or caused by a hardware failure, or if it's down due to maintenance), the standby server takes over the shared IP address of the active node and continues serving the provisioning interface.

## 2.4. SIP Signaling and Media Relay

In SIP-based communication networks, it is important to understand that the signaling path (e.g. for call setup and tear-down) is completely independent of the media path. On the signaling path, the involved endpoints negotiate the call routing (which user calls which endpoint, and via which path - e.g. using SIP peerings or going through the PSTN - the call is established) as well as the media attributes (via which IPs/ports are media streams sent and which capabilities do these streams have - e.g. video using H.261 or Fax using T.38 or plain voice using G.711). Once the negotiation on signaling level is done, the endpoints start to send their media streams via the negotiated paths.

On a CARRIER any signalling traffic enters and leaves the system via load balancers, which act as a perimeter towards the customer devices and performs NAT handling, DoS and DDoS mitigation. New connections are routed to a random pair of proxy servers, which do the actual routing for SIP. The proxy servers also engage media relays for voice and video streams, which bypass the load balancers and communicate directly with the customer devices for performance reasons.

The components involved in SIP and Media on the Sipwise C5 PRO/CARRIER are shown in the following figure:

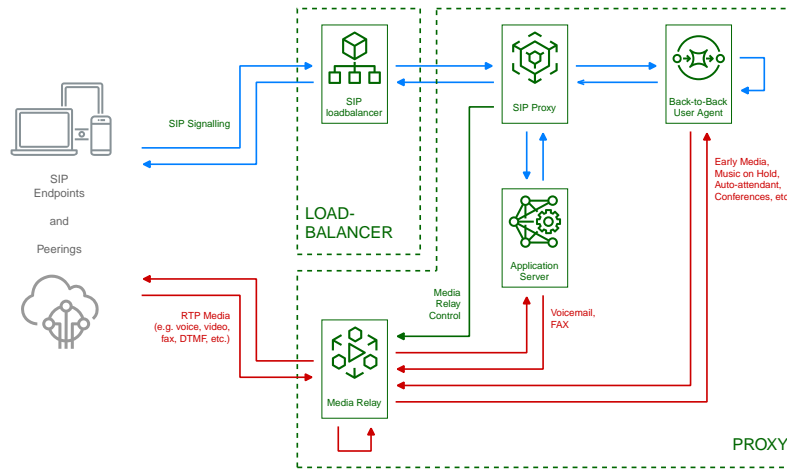

Figure 4. SIP and Media Relay Components

### 2.4.1. SIP Load-Balancer

The SIP load-balancer is a Kamailio instance acting as ingress and egress point for all SIP traffic to and from the system. It's a high-performance SIP proxy instance based on Kamailio and is responsible for sanity checks of inbound SIP traffic. It filters broken SIP messages, rejects loops and relay attempts and detects denial-of-service and brute-force attacks and gracefully handles them to protect the underlying SIP elements. It also performs the conversion of TLS to internal UDP and vice versa for secure signaling between endpoints and Sipwise C5, and does far-end NAT traversal in order to enable signaling through NAT devices.

The load-balancer is the only SIP element in the system which exposes a SIP interface to the public network. Its second leg binds in the switch-internal network to pass traffic from the public internet to the corresponding internal components.

The name load-balancer comes from the fact that when scaling out Sipwise C5 beyond one pair of servers, the load-balancer instance becomes its own physical node and then handles multiple pairs of proxies behind it.

On the public interface, the load-balancer listens on port 5060 for UDP and TCP, as well as on 5061 for TLS connections. On the internal interface, it speaks SIP via UDP on port 5060 to the other system components, and listens for XMLRPC connections on TCP port 5060, which can be used to control the daemon.

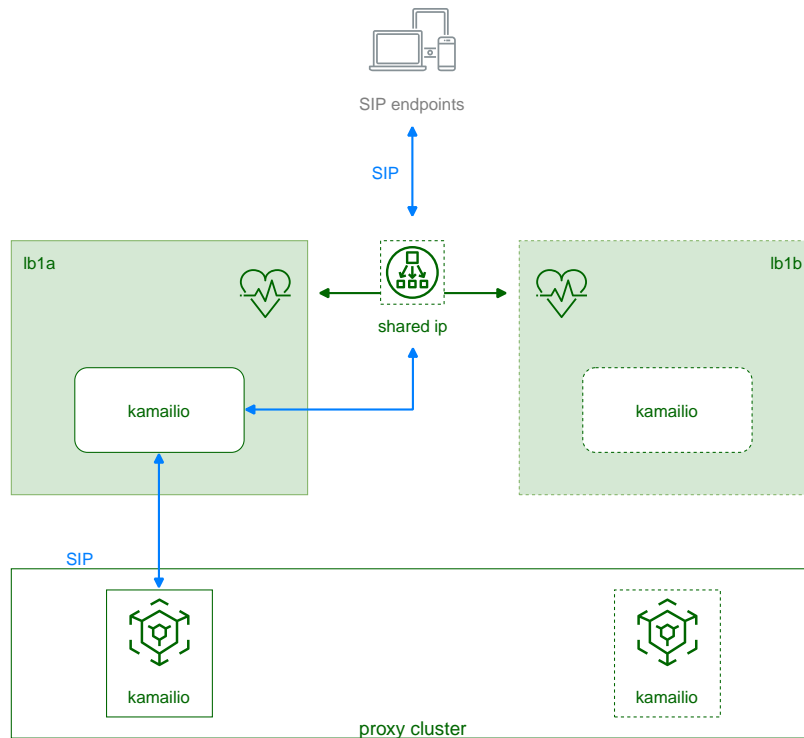

Figure 5. CARRIER Load Balancer Overview

A node in a load balancer pair runs one service besides the usual HA service.

A state-less instance of kamailio, providing an extremely fast relay of SIP messages. Kamailio takes care of converting TCP and TLS connections from the customer devices to UDP for internal communication towards proxies, and it performs far-end NAT traversal by inspecting the SIP messages and comparing it to the actual source address where packets have been received from, then modifying the SIP messages accordingly. If a SIP message is received by the load balancer, it distinguishes between new and ongoing SIP transactions by inspecting the To-Tags of a message, and it determines whether the message is part of an established dialog by inspecting the Route header. Sanity checks are performed on the headers to make sure the call flows adhere to certain rules for not being able to bypass any required element in the routing path. In-dialog messages are routed to the corresponding proxy servers according to the Route defined in the message. Messages initiating a new transaction and/or dialog (registrations, calls etc) are routed to a randomly selected proxy. The selection algorithm is based on a hash over the Call-ID of the message, so the same proxy sending a authentication challenge to an endpoint will receive the authenticated message again.

Its config files reside in `/etc/ngcp-config/templates/etc/kamailio/lb/`, and changes to these files are applied by executing `ngcpcfg apply "my commit message"`.

#### TIP

The SIP load-balancer can be managed via the commands `ngcp-service start kamailio-lb`, `ngcp-service stop kamailio-lb` and `ngcp-service restart kamailio-lb`. Its status can be queried by executing `ngcp-service status kamailio-lb` or `ngcp-service summary | grep "kamailio-lb"`. Also `ngcp-kamctl lb` and `ngcp-kamcmd lb` are provided for querying kamailio functions, for example: `ngcp-kamcmd lb htable.dump ipban`. Execute the command: `ngcp-kamctl lb fifo system.listMethods` or `ngcp-kamcmd lb system.listMethods` to get the list of all available queries.

## 2.4.2. SIP Proxy/Registrar

The SIP proxy/registrar (or short *proxy*) is the work-horse of Sipwise C5. It's also a separate Kamailio instance running in the switch-internal network and is connected to the provisioning database via MySQL, authenticates the endpoints, handles their registrations on the system and does the call routing based on the provisioning data. It is also connected to no-sql backend (Redis) for processing speed purposes and for e.g. in this way manages ACC data, location records etc. For each call, the proxy looks up the provisioned features of both the calling and the called party (either subscriber or domain features if it's a local caller and/or callee, or peering features if it's from/to an external endpoint) and acts accordingly, e.g. by checking if the call is blocked, by placing call-forwards if applicable and by normalizing numbers into the appropriate format, depending on the source and destination of a call.

It also writes start- and stop-records for each call, which are then transformed into call detail records (CDR) by the mediation system.

If the endpoints indicate negotiation of one or more media streams, the proxy also interacts with the *Media Relay* to open, change and close port pairs for relaying media streams over Sipwise C5, which is especially important to traverse NAT.

The proxy listens on UDP port 5062 in the system-internal network. It cannot be reached directly from the outside, but only via the SIP load-balancer.

Its config files reside in `/etc/ngcp-config/templates/etc/kamailio/proxy/`, and changes to these files are applied by executing `ngcpcfg apply "my commit message"`.

### TIP

The SIP proxy can be controlled via the commands `ngcp-service start kamailio-proxy`, `ngcp-service stop kamailio-proxy` and `ngcp-service restart kamailio-proxy`. Its status can be queried by executing `ngcp-service status kamailio-proxy` or `ngcp-service summary | grep "kamailio-proxy"`. Also `ngcp-kamctl proxy` and `ngcp-kamcmd proxy` are provided for querying kamailio functions, for example: `ngcp-kamctl proxy ul show`. Execute the command: `ngcp-kamctl proxy fifo system.listMethods` or `ngcp-kamcmd proxy system.listMethods` to get the list of all available queries.

## 2.4.3. SIP Back-to-Back User-Agent (B2BUA)

The SIP B2BUA (also called SBC within the system) decouples the first call-leg (calling party to Sipwise C5) from the second call-leg (Sipwise C5 to the called party).

The software part used for this element is a commercial version of SEMS, with the main difference to the open-source version that it includes a replication module to share its call states with the stand-by node.

This element is typically optional in SIP systems, but it is always used for SIP calls (INVITE) that don't have Sipwise C5 as endpoint. It acts as application server for various scenarios (e.g. for feature provisioning via Vertical Service Codes and as Conferencing Server) and performs the B2BUA decoupling, topology hiding, caller information hiding, SIP header and Media feature filtering, outbound registration, outbound authentication, Prepaid accounting and call length limitation as well as Session Keep-Alive handler.

Due to the fact that typical SIP proxies (like the load-balancer and proxy in Sipwise C5) do only interfere with the content of SIP messages where it's necessary for the SIP routing, but otherwise leave the message intact as received from the endpoints, whereas the B2BUA creates a new call leg with a new

SIP message from scratch towards the called party, SIP message sizes are reduced significantly by the B2BUA. This helps to bring the message size under 1500 bytes (which is a typical default value for the MTU size) when it leaves Sipwise C5. That way, chances of packet fragmentation are quite low, which reduces the risk of running into issues with low-cost SOHO routers at customer sides, which typically have problems with UDP packet fragmentation.

The SIP B2BUA only binds to the system-internal network and listens on UDP port 5080 for SIP messages from the load-balancer or the proxy, on UDP port 5048 for control messages from the cli tool and on TCP port 8090 for XMLRPC connections to control the daemon.

In cases when B2B is engaged into processing the media (RTP/RTCP data), it uses this UDP ports range by default: 15000 - 19999.

Its configuration files reside in `/etc/ngcp-config/templates/etc/sems-b2b`, and changes to these files are applied by executing `ngcpcfg apply "my commit message"`.

**TIP**

The SIP B2BUA can be controlled via the commands `ngcp-service start b2b`, `ngcp-service stop b2b` and `ngcp-service restart b2b`. Its status can be queried by executing `ngcp-service status b2b` or `ngcp-service summary | grep "b2b"`.

#### 2.4.4. SIP App-Server

The SIP App-Server is an Asterisk instance used for voice applications like Voicemail and Reminder Calls. It is also used in the software-based Faxserver solution to transcode SIP and RTP into the IAX protocol and vice versa, in order to talk to the Software Fax Modems. Asterisk uses the MySQL database as a message spool for voicemail, so it doesn't directly access the file system for user data. The voicemail plugin is a slightly patched version based on Asterisk 16.2.1 to make Asterisk aware of Sipwise C5 internal UUIDs for each subscriber. That way a SIP subscriber can have multiple E164 phone numbers, but all of them terminate in the same voicebox.

The App-Server listens on the internal interface on UDP port 5070 for SIP messages and by default uses media ports in the range from UDP port 10000 to 14999.

The configuration files reside in `/etc/ngcp-config/templates/etc/asterisk`, and changes to these files are applied by executing `ngcpcfg apply "my commit message"`.

**TIP**

The SIP App-Server can be controlled via the commands `ngcp-service start asterisk`, `ngcp-service stop asterisk` and `ngcp-service restart asterisk`. Its status can be queried by executing `ngcp-service status asterisk` or `ngcp-service summary | grep "asterisk"`.

#### 2.4.5. Message Routing and Media Relay

The Media Relay (also called *rtengine*) is a Kernel-based packet relay, which is controlled by the SIP proxy. For each media stream (e.g. a voice and/or video stream), it maintains a pair of ports in the range of port number 30000 to 44999. When the media streams are negotiated, *rtengine* opens the ports in user-space and starts relaying the packets to the addresses announced by the endpoints. If packets arrive from different source addresses than announced in the SDP body of the SIP message (e.g. in case of NAT), the source address is implicitly changed to the address the packets are received from. Once the call is established and the *rtengine* has received media packets from both endpoints for this call, the media stream is pushed into the kernel and is then handled by a custom Sipwise iptables module to increase the throughput of the system and to reduce the latency of media packets.

The rtpengine internally listens on UDP port 12222 for control messages from the SIP proxy. For each media stream, it opens two pairs of UDP ports on the public interface in the range of 30000 and 40000 per default, one pair on even port numbers for the media data, and one pair on the next odd port numbers for metadata, e.g. RTCP in case of RTP streams. Each endpoint communicates with one dedicated port per media stream (opposed to some implementations which use one pair for both endpoints) to avoid issues in determining where to send a packet to. The rtpengine also sets the QoS/ToS/DSCP field of each IP packet it sends to a configured value, 184 (0xB8, *expedited forwarding*) by default.

The kernel-internal part of the rtpengine is facilitated through an *iptables* module having the target name **RTPEENGINE**. If any additional firewall or packet filtering rules are installed, it is imperative that this rule remains untouched and stays in place. Otherwise, if the rule is removed from iptables, the kernel will not be able to forward the media packets and forwarding will fall back to the user-space daemon. The packets will still be forwarded normally, but performance will be much worse under those circumstances, which will be especially noticeable when a lot of media streams are active concurrently. See the section on [Firewalling](#) for more information.

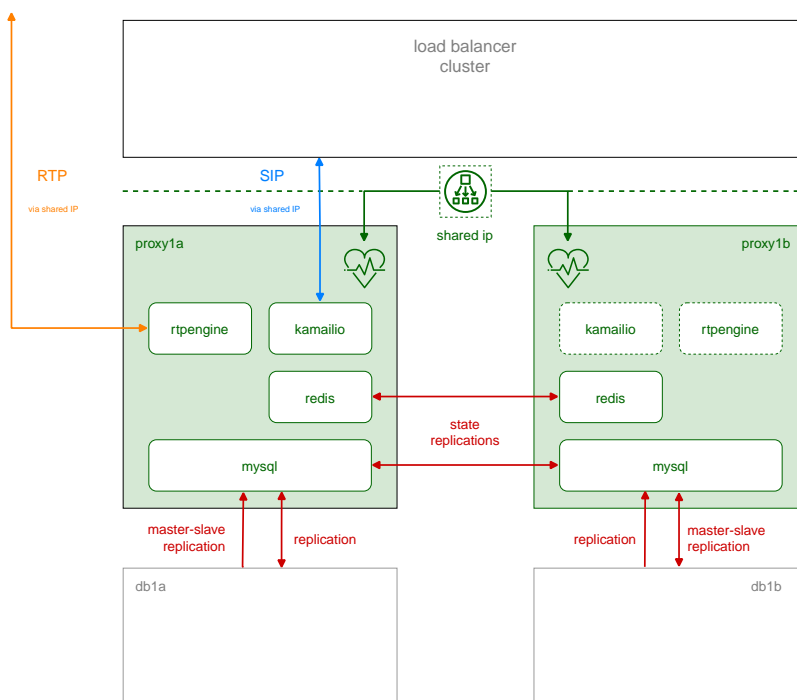

Figure 6. CARRIER Proxy Server Overview

Proxy servers also come in pairs, and by default there are four pairs of proxies in a standard Sipwise C5 CARRIER setup.

The proxies are responsible for doing the actual SIP routing and media handling. Each proxy pair can handle any subscriber on the overall system, compared to the concept of "home proxies" in other architectures. The advantage of this approach is that the overall system can be scaled extremely easily by adding more proxy pairs without having to redistribute subscribers.

Once a load balancer sends a new message to a proxy, the SIP transaction and/or dialog gets anchored to this proxy. That way it is ensured that a call starting on a proxy is also ended on the same proxy. Hence, the full range of feature handling like media relay, voicemail, fax, billing and rating is performed on this proxy. So, there is no a central point for various tasks, potentially leading to a non-scalable bottleneck. Due to the anchoring, proxies come in pairs and replicate all internal state

information to the standby node via Redis. In case of fail-over, the full signalling and media are moved to the standby node without interruption.

The complete static subscriber information like authentication credentials, number mappings, feature settings etc. are replicated from the db cluster down to the local MySQL instance of the proxies. The ratio of db read requests of static subscriber data versus reading and writing volatile and shared data is around 15:1, and this approach moves the majority of the static read operations from the central db cluster to the local proxy db.

Volatile and shared information needed by all proxies in the cluster is read from and written to the db cluster. This mainly includes SIP registration information.

Billing and rating is also performed locally on the proxies, and only completed CDRs (rated or unrated depending on whether rating is enabled) are transferred to the central db cluster for consumption via the northbound interfaces.

For SIP, the relevant instances on a proxy are kamailio acting as a stateful proxy for SIP registration and call routing, sems acting as a back-to-back user-agent for prepaid billing and application server, rtpengine as media relay and RTP/SRTP transcoder, and asterisk as voicemail server. Several billing processes mediate start and stop records into CDRs and rate them according to the relevant billing profiles.

The rtpengine configuration file is `/etc/ngcp-config/templates/etc/default/ngcp-rtpengine-daemon`, and changes to this file are applied by executing `ngcpcfg apply "my commit message"`. The UDP port range can be configured via the `config.yml` file under the section `rtpengine`. The QoS/ToS value can be changed via the key `qos.tos_rtp`.

**TIP**

The Media Relay can be controlled via the commands `ngcp-service start rtpengine`, `ngcp-service stop rtpengine` and `ngcp-service restart rtpengine`. Its status can be queried by executing `ngcp-service status rtpengine` or `ngcp-service summary | grep "rtpengine"`.

## 2.5. MySQL Database

The MySQL database consists of a pair of active/standby MySQL servers. They run a MySQL master/master replication with replication integrity checks to ensure data consistency and redundancy.

The MySQL servers on both physical nodes synchronize via the row-based master/master replication. In theory, any of the two servers in the pair can be used to write data to the database, however, in practice the shared IP address is used towards clients accessing the service, hence only the active MySQL server will receive the write requests and replicate them to the standby one.

### 2.5.1. Provisioning Database (CARRIER-only)

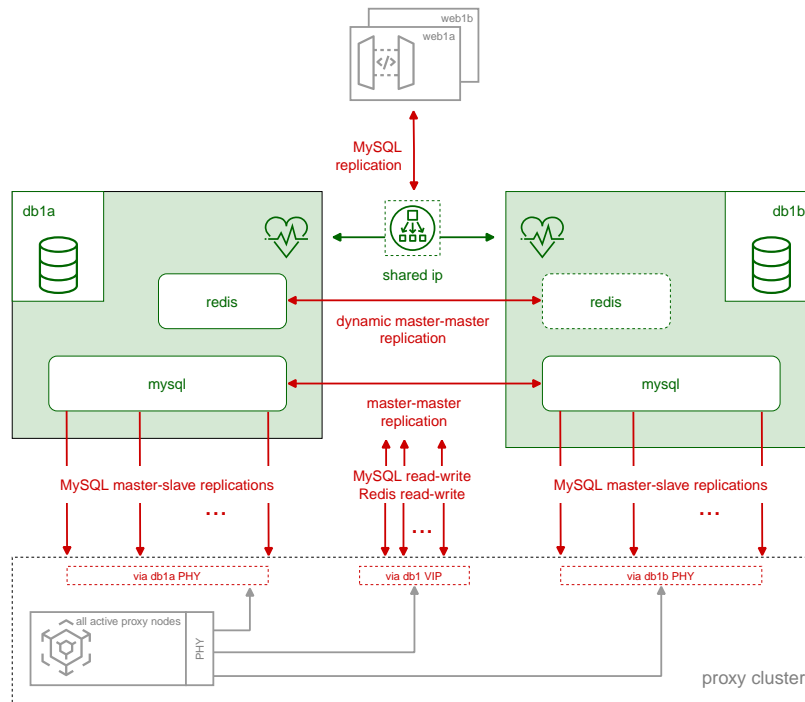

Figure 7. CARRIER DB Server Overview

The db server pair is another active/standby pair with automatic fail-over. Nodes in the pair are running a MySQL master/master replication with replication integrity checks to ensure data redundancy and safety. Any changes via provisioning interfaces are stored in the MySQL cluster. The second service is a Redis master/slave replication with automatic master propagation on fail-over. This Redis cluster is used as a high-performance volatile system cache for various components which need to share state information across nodes.

### 2.5.2. Persistent MySQL Database (CARRIER-only)

The MySQL instances on the *db* nodes synchronize via row-based master/master replication. In theory, any of the two servers in the pair can be used to write data to the database, however in practice a shared IP is used towards clients accessing the service, so only one node will receive the write requests. This is done to ensure transparent and instant convergence of the db cluster on fail-over for the clients.

On top of that, the first node of the db pair also acts as a master in a master/slave replication towards all *proxy* nodes in the system. That way, proxies can access read-only provisioning data directly from their local databases, resulting in reduced latency and significant off-loading of read queries on the central db cluster.

## 2.6. Redis Database

The Redis database is used as a high-performance key/value storage for global system data shared across proxies. This includes calls information and concurrent calls counters for customers and subscribers, etc..

The active-standby replication ensures that the data is immediately copied from the active node to the standby one. As all sensitive call information is held in the shared storage, Sipwise C5 makes it possible to switch the operational state from active to standby on one physical node and from standby to active

on the other node without any call interruptions. Your subscribers will never notice that their calls being established on one physical server, were successfully moved to another one and successfully completed there.

On a CARRIER a Redis master/slave setup is used to provide a high-performance key/value storage for global system data shared across proxies. This includes concurrent call counters for customers and subscribers, as a subscriber could place two simultaneous calls via two different proxy pairs.

## 2.7. High Availability and Fail-Over

### 2.7.1. Overview

The two servers of a complete Sipwise C5 system form a pair, a simple cluster with two nodes. Their names are fixed as `sp1` and `sp2`, however neither of them is inherently a *first* or a *second*. They're both equal and identical and either can be the active node of the cluster at any time. Only one node is always ever active, the other one is in standby mode and does not perform any active functions.

High availability is achieved through constant communication between the two nodes and constant state replication from the active node to the standby one. Whenever the standby node detects that the other node has become unresponsive, has gone offline and has failed in any other way, it will proceed with taking over all resources and becoming the active node, with all operations resuming where the failed node has left off. Through that, the system will remain fully operational and service disruption will be minimal.

When the failed node comes back to life, it will become the new standby node, replicate everything that has changed in the meantime from the new active node, and then the cluster will be back in fully highly available state.

#### TIP

The login banner at the SSH shell provides information about whether the local system is currently the active one or the standby one. See [Administration](#) for other ways to differentiate between the active and the standby node.

### 2.7.2. Nomenclature

The HA architecture consists of two components: the Group Communication System, also known as GCS, and the Cluster Resource Manager, also known as CRM.

In Sipwise C5 these components are implemented by Corosync acting as the CGS, and Pacemaker acting as the CRM.

See the [Corosync/Pacemaker](#) chapter for detailed information.

### 2.7.3. Core Concepts and Configuration

The direct Ethernet crosslink between the two nodes provides the main mechanism of HA communication between them. All state replication happens over this link. Additionally, the GCS service uses this link to communicate with the other node to see if it's still alive and active. A break in this link will therefore result in a *split brain* scenario, with either node trying to become the active one. This is to be avoided at all costs.

The `config.yml` file allows specification of a list of *ping nodes* under the key `ha.pingnodes`, which are used by the CRM service to determine if local network communications are healthy. Both servers

will then constantly compare the number of locally reachable ping nodes with each other, and if the standby server is able to reach more of them, then it will become the active one.

The main resource that the CRM service manages is the shared service IP address. Each node has its own static IP address configured on its first Ethernet interface (`neth0`), which is done outside of the Sipwise C5 configuration framework (i.e. in the Debian-specific config file `/etc/network/interfaces`). The shared service IP is specified in `network.yml` at the key `hosts.sp1|sp2.neth0.shared_ip`. The CRM service will configure it as a secondary IP address on the first Ethernet interface (`neth0:0`) on the active node and will deconfigure it on the standby node. Thus, all network communications with this IP address will always go only to the currently active node.

### 2.7.4. Administration

The current status of the local Sipwise C5 node can be determined using the `ngcp-check-active` shell command. This command produces no output, but returns an exit status of `0` for the active node and `1` for the standby node. A more complete shell command to produce visible output could be: `ngcp-check-active -v`

To force a currently active node into standby mode, use the command `ngcp-make-standby`. For the opposite effect, use the command `ngcp-make-active`. This will also always affect the state of the other node, as the system automatically makes sure that always only one node is active at a time.

## 2.8. Scaling CARRIER beyond one Hardware Chassis

If Sipwise C5 CARRIER is scaled beyond 250,000 subscribers and therefore exceeds one chassis, a second chassis is put into place. This chassis provides another two web servers, two db servers, two load balancers and 8 proxies, doubling the capacity of the system.

### 2.8.1. Scaling the DB cluster

The DB cluster is the only node type which requires a notable change on the architecture.

DB01a/b nodes have master<->master replication for High-Availability

DB01prx01a + DB01prx01b are masterslave replication for read/write scale (write to remote/shared db01, read from local prx DB).

Separate hot and cold data. Hot in Redis for low IO. Cold in MariaDB.

Separate huge data (e.g. voicemail, voisniff data) to separate 'storage' DB node.

With such setup the central db01 pair can handle all the planned and unexpected DB load without the significant hardware resource usage. DB01a and DB01b can be located in different Geo-locations for High-Availability (low latency link is required for replications).

Further DB nodes scalability can be achieved using Geo-redundant setup. Please contact Sipwise sales team for more details here.

### 2.8.2. Scaling the proxy cluster

New proxy nodes replicate via master/slave from the `db` nodes in the chassis as usual. Since the db cluster holds all provisioning information of all subscribers, the `proxy` nodes join the cluster

transparently and will start serving subscribers as soon as all services on a new proxy are reachable from the load balancers.

### 2.8.3. Scaling the load balancers

Load balancers start serving subscribers as soon as they are made visible to the subscribers. This could either be done via DNS round-robin, but the better approach is to configure a DNS SRV record, which allows for more fine-grained control like weighting load-balancer pairs and allowing fail-over from one pair to another on the client side.

The load balancers use the Path extension of SIP to make sure during SIP registration that calls targeted to a subscriber are routed via the same load balancer pair which the subscriber used during registration for proper traversal of symmetric NAT at the customer premise.

A SIP request reaching a load balancer can be routed to any available proxy in the whole system, or only to proxies belonging to the same chassis as the load balancer, depending on the system configuration.

### 2.8.4. Scaling the web servers

New web server pairs are made available to web clients via DNS round-robin. Any pair of web servers can be used to read or write provisioning information via the web interfaces or the API.

## 2.9. Scaling to a Multi-Site Geo-Redundant setup

A basic Multi-Site Geo-Redundant configuration can be achieved by simply deploying all the sp1 nodes (A nodes in case of CARRIER) into a location and the sp2 nodes (B nodes in case of CARRIER) into another one. The locations have to be connected by a reliable and low latency layer 2 link.

This setup has many advantages and gives the possibility to have full business continuity in case one of the locations goes completely down but it has also some drawbacks:

- in case one site goes down, the remaining site is in an 'unstable' state due to missing HA nodes.
- only one location is active at a time. Therefore it is not possible to take advantage of all the benefits of a geo-located system.
- in case the connection between the two systems goes down, a split brain scenario will happen causing an instability of the whole system.

A new alternative approach consists of the deployment of two fully operational PRO or Carrier systems, from now on referred to as 'cluster', connected by the aforementioned reliable and low latency link.

Compared to the previous setup, this configuration has the following advantages:

- single management interface access (API and Web interface) for both systems
- geo-locate the SIP/RTP connections and traffic in order to always connect endpoints to the nearest cluster (it requires dedicated network configurations)
- fallback of the endpoint connections to the other cluster node
- communications between subscribers registered on different clusters remains internal
- in case one cluster goes down, the other continues to work in standard mode with a local HA

- in case the interconnection between clusters goes down, the two systems continue to work independently. After the connection is re-established, a dedicated DB resynchronization will happen.

**IMPORTANT**

In this architecture the interconnection link between the two clusters will be used not only for database replica and internal synchronization but also for internal SIP/RTP traffic. Due to that, it is important that the link has very low latency and high throughput.

The final setup looks like:

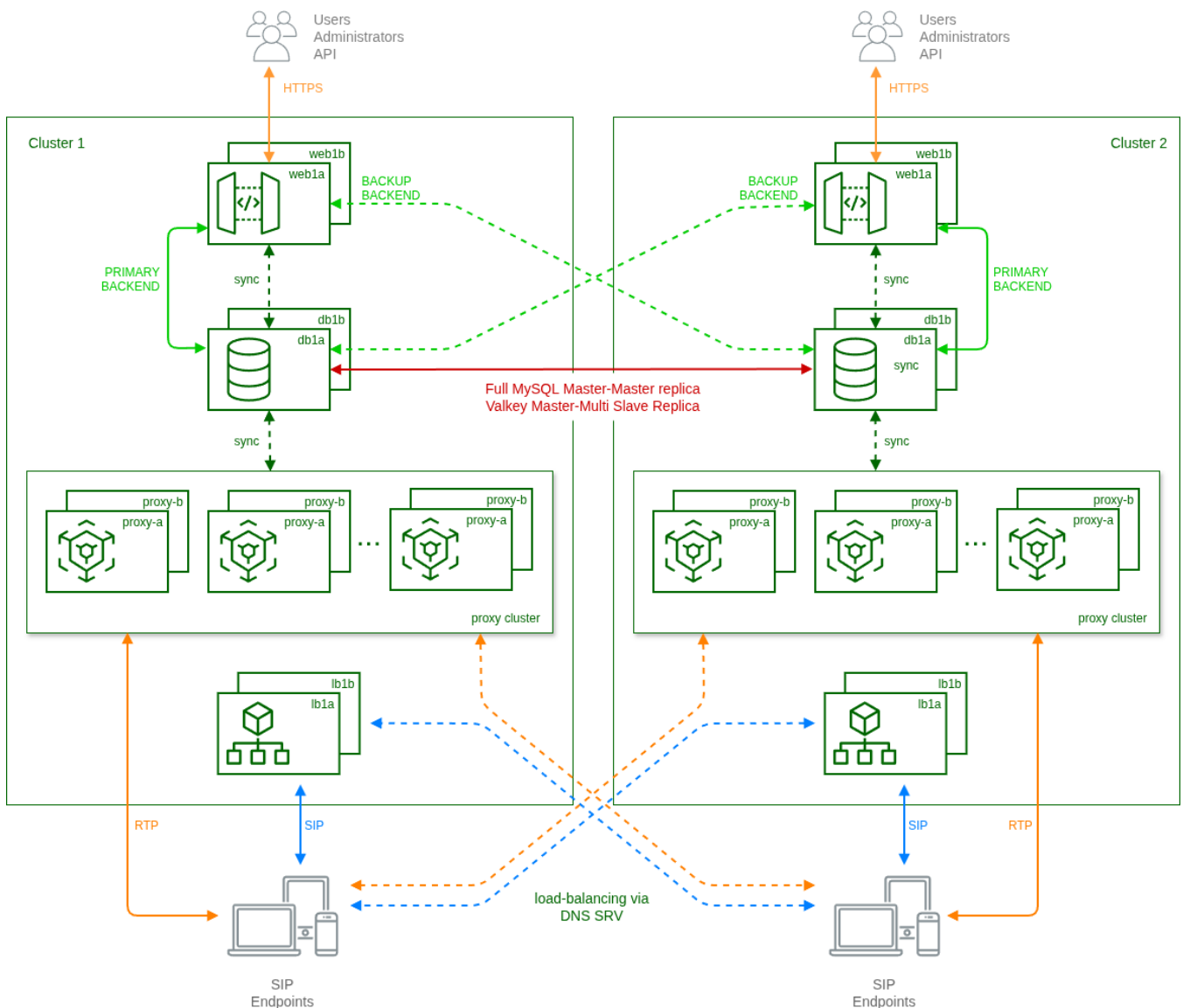

Figure 8. Geo-Redundant Carrier Overview

In particular:

- each 'web' node has a built-in mechanism based on ha-proxy to select which 'db' node to use as backend. By default they always try to use the local node as primary connection and switch to the remote node in case of missing local connection or faulty local replica status.
- mysql databases, running on 'db' nodes, are in a full master-master replica setup. This is to ensure the presence of same data (provisioning, locations, CDRs, etc.) on both clusters.

- new valkey-central database services, running on 'db' nodes, are spinned up and configured in a master-multi\_slave replica setup. They also have a mechanism, based on ha-proxy, to select which database node to use as backend.
- each cluster uses local 'lb' and 'prx' nodes as in standard carrier/pro architecture, except when the called subscriber is registered on the other cluster. In these cases local 'prx' node can directly contact the remote 'lb' to route the calls to the final destination.
- using DNS-SRV records, endpoints are usually registered on the nearest cluster. In case of failure of the local connection, then DNS-SRV is responsible to route new registrations to remote cluster.
- ngcpcfg framework enables the operator to manage the whole system from one cluster node.

For any additional details on the Geo-Redundant setup and how to configure it, please contact Sipwise sales team.

# Chapter 3. Deployment

This chapter provides a step by step instruction on how to set up a Sipwise C5 CARRIER/Pro nodes from scratch.

## 3.1. Installation Prerequisites

### 3.1.1. KVM

Use an USB Keyboard and any Monitor with VGA connector (male three-row 15-pin DE-15). A Mouse is not required.

### 3.1.2. Install Medium

The install CD provides the ability to easily install Sipwise C5 CE/PRO/Carrier, including automatic partitioning and installation of the underlying Debian system.

Burn the ISO to a CD with an application of your choice, or preferably put the ISO on a USB stick (all data will be wiped from there):

```
% dd if=sip_provider_mr26.0.1.iso of=/dev/sdX
```

#### IMPORTANT

Do **not** specify a partition (like /dev/sdb1), but only the disk itself (like /dev/sdb) since the ISO already provides a partition table.

#### NOTE

When dd-ing the ISO to a device the system is **NOT** (U)EFI capable. To be able to boot the device using (U)EFI you need to set it up using grml2usb, see the following section for further details.

#### Instructions for setting up (U)EFI capable USB device using grml2usb

Install grml2usb (see [grml.org/grml2usb](http://grml.org/grml2usb)) or boot a Grml/Grml-Sipwise ISO to be able to use its grml2usb.

Create a FAT16 partition on the USB pen and enable the boot flag for the partition. The GParted tool is known to work fine:

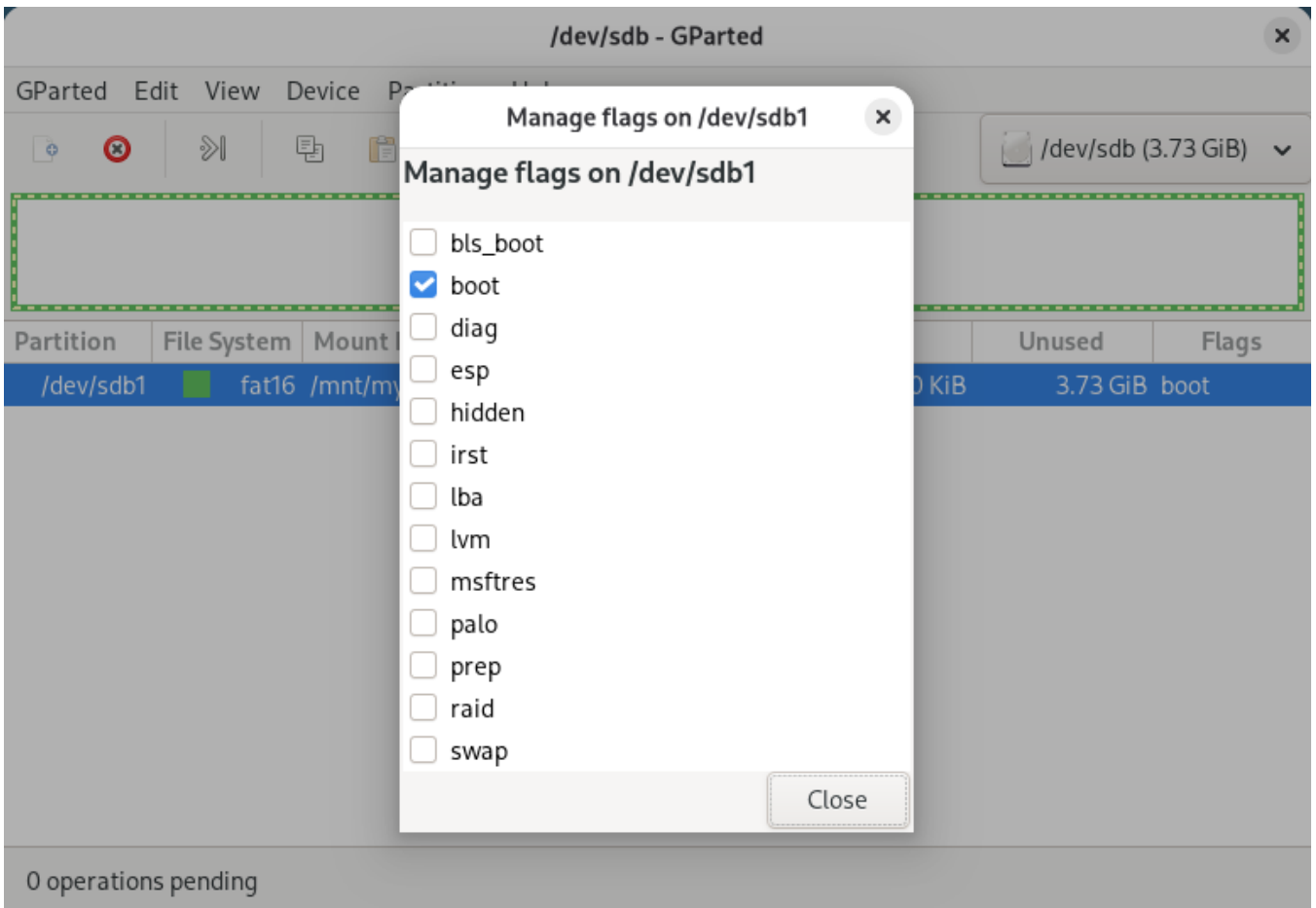

Then invoke as root or through sudo (adjust /dev/sdX accordingly for your USB device):

```
# grml2usb sip_provider_mr26.0.1.iso /dev/sdX1
```

That's it.

This is how (U)EFI boot looks like:



whereas that's how BIOS boot looks like:



### Instructions for setting up (U)EFI capable USB device on Mac OS

Invoke the Disk Utility (in german locales: "Festplatten-Dienstprogramm"), select the USB stick. Choose the partitioning tab, choose "1 Partition" in Volume Schema, name it "SIPWISE" and choose MS-DOS (FAT) as file system. Then "Apply" the settings.

Double-click on the Grml-Sipwise ISO and switch to a terminal, invoke "diskutil" to identify the device name of the ISO (being /dev/disk2s1 in the command line below).

Finally mount the first partition of the ISO and copy the files to the USB device, like:

```
% mkdir /Volumes/GRML
% sudo mount_cd9660 /dev/disk2s1 /Volumes/GRML
% cp -a /Volumes/GRML/* /Volumes/SIPWISE/
% diskutil unmount /Volumes/SIPWISE/
% sudo umount /Volumes/GRML
% sudo umount /Volumes/GRML
```

The resulting USB Stick should be bootable in (U)EFI mode now, meaning it should also boot on recent Mac OS systems (press the Option/Alt key there during boot and choose "EFI Boot" then).

### 3.1.3. Network

The setup routine needs both access to Sipwise mirror of public Debian repositories (<https://debian.sipwise.com>), to the Sipwise repositories (<https://deb.sipwise.com>) and Sipwise license server (<https://license.sipwise.com>).

## 3.2. Installation CARRIER

This section describes how to install vanilla carrier installation.

### 3.2.1. CARRIER Hardware

Sipwise C5 CARRIER starts with a minimum deployment of 50.000 subscribers, requiring one chassis with two web servers, two db servers, two load balancers and two proxies. A fully deployed Sipwise C5 CARRIER for 200.000 subscribers fills the chassis up with 14 servers, containing two web servers, two db servers, two load balancers and 8 proxies.

### 3.2.2. Power supply

Connect at least 2 power cords to chassis power supplies.

### 3.2.3. Initial chassis configuration

Connect Patch cords to Active CMM node on the backside of each chassis and connect them to the switch.

### 3.2.4. Chassis IP-management setup

By default chassis will try to obtain address using DHCP protocol, if not:

- connect using laptop to CMM try to use IP from label on CMM
- setup IP address

Change CMM password to at least 12-chars string generated using Linux *pwgen* as an example.

Change Password for switch modules (IO).

**TIP**

Remember to download for CRM FRU numbers: Status Table View Export to CSV Also it will be useful to copy SN numbers to that CSV file.

Login to CMM and Copy Mac Address of first adapter of Each node through:

- Chassis Management Reports Mac Address and copy Mac1 Column

On each compute node check and configure:

- Raid setup: for deployments we are using RAID1
- Select Legacy boot mode (Boot Legacy mode)

### 3.2.5. Bootstrapping first node

First node you have to install is: **web01a** All another nodes are using web01a as PXE boot server and source of Debian-packages.

Insert the Install Medium (when using USB or CD), reboot the server, and when prompted in the top right corner, press *F11* to access the Boot menu. Choose *SATA Optical Drive* when using a CD, or *Hard drive C:Removable XXX* when using a USB stick.

You will be presented with the Sipwise installer bootsplash:



Navigate down to mr26.0.1 CARRIER (web01a) and press <enter> to start the automatic installation process. This will take quite some time (depending on the network connection speed and the installation medium).

Once the Debian base system is installed and the ngcp-installer is being executed, you can login via ssh to *root@<ip>* (password is *sipwise* as specified by the ssh boot option) and watch Sipwise C5 installation process by executing *tail -f /mnt/var/log/ngcp-installer.log -f /tmp/deployment-installer-debug.log*). After the installation has been finished and when prompted on the terminal to do so, press *r* to reboot. Make sure the Install Medium is ejected in order to boot into the newly installed system. Once up, you can login with user *root* and password *sipwise*.

Then you need to run the initial configuration for the first node:

#### WARNING

It is strongly recommended to run ngcp-initial-configuration within terminal multiplexer like screen.

```
screen -S ngcp
ngcp-initial-configuration
```

### 3.2.6. Network Configuration

For successful bootstrapping all other nodes you have to correctly fill in the network.yml. You can edit network.yml in your favorite text editor. If needed, add missing sections (for prxoYa and prxoYb) according to the low-level design architecture doc. Important to write down into 'ha\_int' section mac address of first adapter (MAC1), only network adapters with particular Mac-address, which are listed in network.yml are able to boot over PXE and be provisioned by API. Then you should apply your configuration changes, Use the following commands:

```
ngcpcfg apply "Initial network configuration"
ngcpcfg push --shared-only
```

### 3.2.7. Deployment of the rest nodes in chassis

Prior deployment of additional node you must enable ngcpcfg\_api service. Run:

```
ngcpcfg set /etc/ngcp-config/config.yml 'bootenv.ngcpcfg_api.enable=yes'
&&
ngcpcfg commit 'Activate bootenv API in config.yml'
```

**WARNING**

After deployment complete ngcpcfg\_api.enable must set to "no" due to security constraint!

Power ON web01b from CMM web GUI (by default it will try to boot over PXE) and wait until web01b is deployed and reboots completely.

**WARNING**

It is strongly recommended to run ngcp-initial-configuration within terminal multiplexer like screen.

Run:

```
screen -S ngcp
ngcp-initial-configuration --join
```

When it is finished you can deploy all other A-nodes even in parallel. After it you can deploy rest B-nodes.

All nodes but web01a should be configured with the '--join' option after the reboot:

**WARNING**

It is strongly recommended to run ngcp-initial-configuration within terminal multiplexer like screen.

```
screen -S ngcp
```

```
ngcp-initial-configuration --join
```

If your web01b is in another chassis you should follow procedure described below:

Disconnect patch-cord cable from EXT1 port of SM1 which was connected to our office switch. Connect cable between the two Switch Modules (EXT1 on SM1 on first chassis and EXT1 on SM1 on second chassis). Power ON web01a from CMM web GUI and wait until web01a boots. Login to CMM on second chassis and start Node for **web01b** (by default it will try to boot over PXE). Wait until web01b is deployed and reboots completely. Begin deployment for all nodes in A-chassis (turn them on even in parallel). After process of deployment A-nodes completes you can deploy rest nodes in B-chassis.

### 3.2.8. Checking install:

SSH on web01a and run the following command:

```
ngcp-status --all
```

On prx-nodes there are two mysql instances running which handles the following replications: sp1<sp2 (port 3306) and db01localhost (port 3308). Check the replication of tables between DB-node and PRX-node with ngcp-mysql-replication-check:

```
root@prx01a:~# ngcp-mysql-replication-check -a -v
[prx01a] Replication slave is running on localhost:3306 from 'sp2'. No
replication errors.
[prx01a] Replication slave is running on 127.0.0.1:3308 from 'db01a'. No
replication errors.
[prx01a] Replication slave is running on 127.0.0.1:3308 from 'db01b'. No
replication errors.
```

## 3.3. Installation Pro

The two nodes are installed one after the other by performing the following steps. It can be bare-hardware installation, virtualised one (Proxmox) or Cloud (Google Cloud).

### 3.3.1. PRO Hardware

This section is valid for bare-hardware installation only.

#### Hardware Specifications

Sipwise provides Sipwise C5 platform fully pre-installed on two Lenovo ThinkSystem SR250 servers. Their most important characteristics are:

- 1x 6C 12T E-2246G CPU @ 3.60GHz
- 64 GB RAM (DDR4 ECC)
- 2x 480Gb Lenovo branded SATA SSD
- 1x 4Port intel i350 add-on network card

## Hardware Prerequisites

In order to put Sipwise C5 into operation, you need to rack-mount it into 19" racks.

You will find the following equipment in the box:

- 2 servers
- 2 pairs of rails to rack-mount the servers
- 2 cable management arms

You will additionally need the following parts as they are not part of the distribution:

- 4 power cables

**NOTE**

The exact type required depends on the location of installation, e.g. there are various forms of power outlets in different countries.

- At least 2 CAT5 cables to connect the servers to the access switches for external communication
- 1 CAT5 cable to directly connect the two servers for internal communication

## Rack-Mount Installation

Install the two servers into the rack (either into a single one or into two geographically distributed ones).

The rails shipped with the servers fit into standard 4-Post 19" racks. If they do not fit, please consult your rack vendor to get proper rails.

The following figure shows the mounted rails:

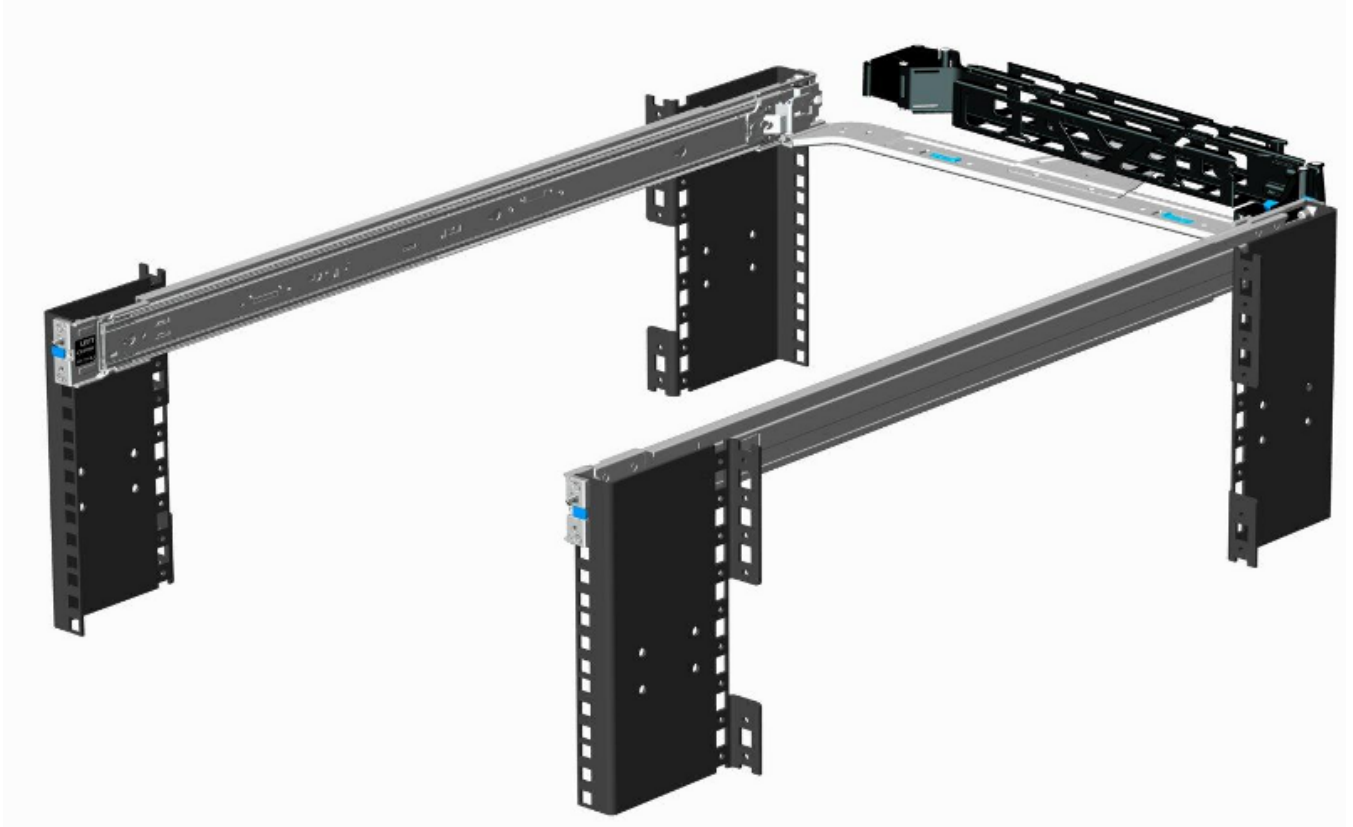

*Figure 9. Rack-mounted Rails*

### **Power Supply Cabling**

Each server has two redundant Power Supply Units (PSU). Connect one PSU to your normal power circuit and the other one to an Uninterruptible Power Supply Unit (UPS) to gain the maximum protection against power failures.

The cabling should look like in the following picture to prevent accidental power cuts:



Figure 10. Proper PSU Cabling

Use a 230V/16A power supply and connect a power cord with a C13 jack to each of the two servers, using any of the two power supply units (PSU) in the back of the servers.

## Network Cabling

### Internal Communication

The *high availability (HA)* feature of Sipwise C5 requires that a direct Ethernet connection between the servers is established. One of the network interfaces must be dedicated to this functionality.

### External Communication

Remaining network interfaces may be used to make the servers publicly available for communication services (SIP, messaging, etc.) and also for their management and maintenance.

### Internal Communication

Patch a cross-link with a straight CAT5 cable between the two servers by connecting the cable to the network interface assigned to the HA component by Sipwise. The direct cross cable is applied for maximum availability because this connection is used by the servers to communicate with each other internally.

#### IMPORTANT

We strongly suggest against using a switch in between the servers for this internal interface. Using a switch is acceptable only if there is no another way to connect the two ports (e.g. if you configure a geographically distributed installation).

#### NOTE

In case you are using a switch for cross-link make sure to enable *portfast* mode on Cisco switches. The thing is that STP puts the port into learning mode for 90 seconds, after it comes up for the first time. During this learning phase, the link is technically up, but no traffic passes through, so the GCS service will detect the other node as dead during boot. The *portfast* mode tells the switch to skip the learning phase and go to forwarding state right away: `spanning-tree portfast [trunk]`.

## External Communication

For both servers, depending on the network configuration, connect one or more straight CAT5 cables to the ports on the servers network cards and plug them into the corresponding switch ports. Information about proper ports of the servers to be used for this purpose are provided by Sipwise.

### 3.3.2. Initial BIOS Configuration

Power on both servers, and when prompted on the top right corner, press *F2* to access the BIOS menu.

*Automatic Power-On Setting:*

Navigate to *System SecurityAC Power Recovery* and change the setting to *On* by pressing the *<right>* key. This will cause the server to immediately boot, as soon as it's connected to the power supply, which helps to increase availability (e.g. after an accidental shutdown, it can be remotely powered on again by power-cycling both PSU simultaneously via an IP-PDU).

Go back with *<esc>* until prompted for *Save changes and exit*, and choose that option.

### 3.3.3. Bootstrapping first node

First node you have to install is: **sp1** **sp2** node is using **sp1** as PXE boot server and source of Debian-packages.

Insert the Install Medium (when using USB or CD), reboot the server, and when prompted in the top right corner, press *F11* to access the Boot menu. Choose *SATA Optical Drive* when using a CD, or *Hard drive C:Removable XXX* when using a USB stick.

You will be presented with the Sipwise installer bootsplash:



Navigate down to `mr26.0.1 PRO (sp1)` and press `<enter>` to start the automatic installation process. This will take quite some time (depending on the network connection speed and the installation medium).

Once the Debian base system is installed and the `ngcp-installer` is being executed, you can login via `ssh` to `root@<ip>` (password is `sipwise` as specified by the `ssh boot` option) and watch Sipwise C5 installation process by executing `tail -f /mnt/var/log/ngcp-installer.log -f /tmp/deployment-installer-debug.log`). After the installation has finished and when prompted on the terminal to do so, press `r` to reboot. Make sure the Install Medium is ejected in order to boot into the newly installed system. Once up, you can login with user `root` and password `sipwise`.

Then you need to run the initial configuration for the first node:

#### WARNING

It is strongly recommended to run `ngcp-initial-configuration` within terminal multiplexer like screen.

```
screen -S ngcp
ngcp-initial-configuration
```

### 3.3.4. Network Configuration

The Sipwise C5 PRO pair uses `eth0` for the public interface, and `eth1` for a small, dedicated internal network on the cross-link for the GCS, replication and synchronization. Both of them are configured automatically at install time.

For the service to be used for SIP, RTP, HTTP etc. you need to configure a floating IP in the same network as you have configured on *eth0*. Put this IP address into the *shared\_ip* array of the interface which contains the *ext* types in */etc/ngcp-config/network.yml*.

```
ngcp-network --set-interface=eth0 --shared-ip=1.2.3.5
```

Once done, execute *ngcpcfg apply "added shared ip"*, which will restart (beside others) the GCM/CRM processes, which in turn will configure a virtual interface *eth0:0* with your floating IP.

For successful bootstrapping sp2 you have to correctly fill in the *network.yml*. You can edit *network.yml* in your favorite text editor. Important to write down into internal interface of sp2 section mac address of second adapter (MAC2), only network adapters with particular Mac-address, which are listed in *network.yml* are able to boot over PXE and be provisioned by API. Then you should apply your configuration changes, Use the following commands:

```
ngcpcfg apply "Initial network configuration"
ngcpcfg push --shared-only
```

After the configuration you can proceed to the second node.

### IMPORTANT

You need to keep sp1 running and connected to the network in order to set up sp2 correctly, because the install procedure automatically synchronizes various configurations between the two nodes during the setup phase.

### Setting up PRO sp2

Prior deployment of additional node you must enable *ngcpcfg\_api* service. Run:

```
ngcpcfg set /etc/ngcp-config/config.yml 'bootenv.ngcpcfg_api.enable=yes'
&&
ngcpcfg commit 'Activate bootenv API in config.yml'
```

### WARNING

After deployment complete *ngcpcfg\_api.enable* must set to "no" due to security constraint!

Power ON sp2 server (by default it will try to boot over PXE) and wait until sp2 is deployed and reboots completely.

### WARNING

It is strongly recommended to run *ngcp-initial-configuration* within terminal multiplexer like *screen*.

Run:

```
screen -S ngcp
ngcp-initial-configuration --join
```

### 3.3.5. Verify running Cluster configuration

After both sp1 and sp2 have been set up and are rebooted into the freshly installed system, one node should show *cluster node active* when logging into the machine, the other node should either have the default message of the day, or *cluster node inactive*.

Check the running processes on both nodes by executing *ngcp-service summary* on both of them.

*Output of the active node:*

```
# ngcp-service summary
Ok Service                Managed   Started   Status
-----
approx                    managed   on-boot   active
asterisk                   managed   by-ha     active
corosync                   managed   on-boot   active
coturn                     unmanaged by-ha     inactive
cron                       managed   on-boot   active
dhcp                       managed   by-ha     active
exim                       managed   on-boot   active
freeswitch                 managed   by-ha     active
fstrim                     managed   on-boot   active
glusterfsd                 managed   on-boot   active
grafana                    managed   on-boot   active
haproxy                    unmanaged on-boot   inactive
irqbalance                 managed   on-boot   active
kamailio-lb                managed   by-ha     active
kamailio-proxy             managed   by-ha     active
kannel-bearerbox           unmanaged by-ha     inactive
kannel-smsbox              unmanaged by-ha     inactive
keydb                      unmanaged on-boot   inactive
keydb-norep                unmanaged on-boot   inactive
mariadb                    managed   on-boot   active
monit                      managed   on-boot   active
ngcp-cdr-exporter          unmanaged by-ha     inactive
ngcp-cudecsd               unmanaged by-ha     inactive
ngcp-faxserver             managed   by-ha     active
ngcp-initialize-udev-rules-net managed   on-boot   active
ngcp-io-scheduler          managed   on-boot   active
ngcp-license-client         managed   on-boot   active
ngcp-lnpd                  unmanaged on-boot   inactive
ngcp-logfs                 managed   on-boot   active
ngcp-logic-engine          unmanaged on-boot   inactive
ngcp-mediator              managed   by-ha     active
ngcp-panel                 managed   on-boot   active
ngcp-pushd                 unmanaged by-ha     inactive
ngcp-rate-o-mat            managed   by-ha     active
ngcp-rest-api              managed   on-boot   active
rtengine                   managed   by-ha     active
rtengine-recording         unmanaged by-ha     inactive
rtengine-recording-nfs-mount unmanaged on-boot   inactive
```

sems-b2b	managed	by-ha	active
ngcp-snmp-agent	managed	on-boot	active
ngcp-task-agent	managed	on-boot	active
ngcp-voisniff	unmanaged	by-ha	inactive
ngcp-websocket	unmanaged	by-ha	inactive
ngcp-witnessd	managed	on-boot	active
ngcpcfg-api	unmanaged	on-boot	inactive
nginx	managed	on-boot	active
ntpd	managed	on-boot	active
openipmi	unmanaged	on-boot	inactive
openvpn	unmanaged	on-boot	inactive
openvpn-vip	unmanaged	by-ha	inactive
pacemaker	managed	on-boot	active
prometheus-haproxy-exporter	managed	on-boot	active
prometheus-mysqld-exporter	managed	on-boot	active
prometheus-nginx-exporter	managed	on-boot	active
prometheus-node-exporter	managed	on-boot	active
prometheus-process-exporter	managed	on-boot	active
prometheus-redis-exporter	managed	on-boot	active
prometheus	unmanaged	on-boot	inactive
syslog	managed	on-boot	active
rtengine-master	unmanaged	by-ha	inactive
slapd	unmanaged	by-ha	inactive
smartmontools	unmanaged	on-boot	inactive
snmpd	managed	on-boot	active
snmptrapd	unmanaged	on-boot	inactive
snmptrapd-socket	unmanaged	on-boot	inactive
ssh	managed	on-boot	active
sssd-nss	unmanaged	on-boot	inactive
sssd-pam	unmanaged	on-boot	inactive
sssd-sudo	unmanaged	on-boot	inactive
sssd	unmanaged	on-boot	inactive
tinyproxy	managed	on-boot	active
valkey-central-master	unmanaged	by-ha	inactive
valkey-master	managed	by-ha	active
valkey	managed	on-boot	active
valkey-central	unmanaged	on-boot	inactive
valkey-norep	unmanaged	on-boot	inactive
victoria-metrics	managed	on-boot	active

*Output of the standby node:*

```
# ngcp-service summary
Ok Service                Managed   Started   Status
--  -----  -
```

approx	managed	on-boot	active
asterisk	managed	by-ha	inactive
corosync	managed	on-boot	active
coturn	unmanaged	by-ha	inactive
cron	managed	on-boot	active

dhcp	managed	by-ha	inactive
exim	managed	on-boot	active
freeswitch	managed	by-ha	inactive
fstrim	managed	on-boot	active
glusterfsd	managed	on-boot	active
grafana	managed	on-boot	active
haproxy	unmanaged	on-boot	inactive
irqbalance	managed	on-boot	active
kamailio-lb	managed	by-ha	inactive
kamailio-proxy	managed	by-ha	inactive
kannel-bearerbox	unmanaged	by-ha	inactive
kannel-smsbox	unmanaged	by-ha	inactive
keydb	unmanaged	on-boot	inactive
keydb-norep	unmanaged	on-boot	inactive
mariadb	managed	on-boot	active
monit	managed	on-boot	active
ngcp-cdr-exporterd	unmanaged	by-ha	inactive
ncgp-cudecsd	unmanaged	by-ha	inactive
ngcp-faxserver	managed	by-ha	inactive
ngcp-initialize-udev-rules-net	managed	on-boot	active
ngcp-io-scheduler	managed	on-boot	active
ngcp-license-client	managed	on-boot	active
ngcp-lnpd	unmanaged	on-boot	inactive
ngcp-logfs	managed	on-boot	active
ngcp-logic-engine	unmanaged	on-boot	inactive
ngcp-mediator	managed	by-ha	inactive
ngcp-panel	managed	on-boot	active
ngcp-pushd	unmanaged	by-ha	inactive
ngcp-rate-o-mat	managed	by-ha	inactive
ngcp-rest-api	managed	on-boot	active
rtengine	managed	by-ha	inactive
rtengine-recording	unmanaged	by-ha	inactive
rtengine-recording-nfs-mount	unmanaged	on-boot	inactive
sems-b2b	managed	by-ha	inactive
ngcp-snmp-agent	managed	on-boot	active
ngcp-task-agent	managed	on-boot	active
ngcp-voisniff	unmanaged	by-ha	inactive
ngcp-websocket	unmanaged	by-ha	inactive
ngcp-witnessd	managed	on-boot	active
ngcpcfg-api	unmanaged	on-boot	inactive
nginx	managed	on-boot	active
ntpd	managed	on-boot	active
openipmi	unmanaged	on-boot	inactive
openvpn	unmanaged	on-boot	inactive
openvpn-vip	unmanaged	by-ha	inactive
pacemaker	managed	on-boot	active
prometheus-haproxy-exporter	managed	on-boot	active
prometheus-mysqld-exporter	managed	on-boot	active
prometheus-nginx-exporter	managed	on-boot	active
prometheus-node-exporter	managed	on-boot	active
prometheus-process-exporter	managed	on-boot	active
prometheus-redis-exporter	managed	on-boot	active

prometheus	unmanaged	on-boot	inactive
syslog	managed	on-boot	active
rtengine-master	unmanaged	by-ha	inactive
slapd	unmanaged	by-ha	inactive
smartmontools	unmanaged	on-boot	inactive
snmpd	managed	on-boot	active
snmptrapd	unmanaged	on-boot	inactive
snmptrapd-socket	unmanaged	on-boot	inactive
ssh	managed	on-boot	active
sssd-nss	unmanaged	on-boot	inactive
sssd-pam	unmanaged	on-boot	inactive
sssd-sudo	unmanaged	on-boot	inactive
sssd	unmanaged	on-boot	inactive
tinypoxy	managed	on-boot	active
valkey-central-master	unmanaged	by-ha	inactive
valkey-master	managed	by-ha	inactive
valkey	managed	on-boot	active
valkey-central	unmanaged	on-boot	inactive
valkey-norep	unmanaged	on-boot	inactive
victoria-metrics	managed	on-boot	active

If your output matches the output above, you're fine.

Also double-check if the replication is up and running by executing `mysql` and do the query `show slave status\G`, which should NOT report any error on both nodes.

### 3.3.6. Synchronizing configuration changes

Between `sp1` and `sp2` there is a shared glusterfs storage, which holds the configuration files. If you change any config option on the active server and apply it using `ngcpcfg apply "my commit message"`, then execute `ngcpcfg push` to propagate your changes to the second node.

#### TIP

Note that `ngcpcfg apply "my commit message"` is implicitly executed on the other node if you push configurations to it.

## 3.4. What's happening when booting the Sipwise Deployment ISO

What happens when booting the Sipwise Deployment ISO is roughly:

- Grml ISO boots up
- The Grml system checks for the `netscript` boot option (specified in the kernel command line which is visible at the boot splash when pressing `<TAB>`)
- The URL provided as argument to the `netscript=` boot option will be downloaded and executed
- The `netscript` provides all the steps that need to be executed depending on which boot options have been specified (see the following section for more information)

### 3.4.1. Deployment stages

If installing Debian or Debian plus ngcp this happens during deployment:

- boot options get evaluated
- if installing a PRO system and usb0 exists IPMI is configured with IP address 169.254.1.102
- checking for some known disks (based on a whitelist) to not cause any data loss by accident, exits if trying to install on an unknown disk type
- starting ssh server for remote access
- partition disk and set up partitions
- make basic software selection using `/etc/debootstrap/packages`
- run `grml-debootstrap` to install Debian base system
- adjusting `/etc/hosts` of target system
- adjusting `/etc/udev/rules.d/70-persistent-net.rules` of target system if installing a virtual PRO system

If installing ngcp the following takes place:

- downloading according ngcp-installer version
- executing ngcp-installer with settings as specified by boot options (see the following section for further information)
- build ngcp-rtpengine kernel module (as this can't be done automatically inside a chroot where kernel version of deployment system doesn't necessarily match the kernel version of the installed system)
- stop any running processes of the ngcp system that have been started during installation
- copy generated log files to installed system
- adjust `/etc/hosts`, `/etc/hostname` and `/etc/network/interfaces` of the installed system
- kill any remaining ngcp system processes
- ask for rebooting/halting the system

### 3.4.2. Important boot options for the Sipwise Deployment ISO

- `arch=i386` - install a 32bit Debian system instead of defaulting to 64bit system (use if so only for non-ngcp installations!)
- `debianrelease=...` - use specified argument as Debian release (instead of defaulting to *trixie*)
- `dns=...` - use specified argument (IP address) as name server
- `ip=$IP::$GATEWAY:$NETMASK:$HOSTNAME:$DEVICE:off` - use static IP address configuration instead of defaulting to DHCP
- `ngcpce` - install CE flavour of ngcp
- `ngcphostname=...` - use specified argument as hostname for the ngcp system
- `ngcpinstvers=...` - use specified argument as ngcp-installer version (e.g. *0.7.3*) instead of defaulting to latest version
- `ngcpsp1` - install PRO flavour of ngcp, system 1 (sp1)

- `ngcpsp2` - install PRO flavour of `ngcp`, system 2 (`sp2`)
- `ngcpppa=...` - Use Sipwise PPA repository during installation
- `nodhcp` - disable DHCP (only needed if no network configuration should take place)
- `nongcp` - do not install any `ngcp` flavour but only a base Debian system
- `puppetenv=...` - install puppet software in target system and enable specified argument as its environment (note that the target system's hostname must be known to puppet's manifest)
- `ssh=...` - start SSH server with specified password for users `root` and `grml`

### 3.4.3. Logfiles

The settings assigned to the `ngcp` installer are available at `/tmp/installer-settings.txt`.

The log file of the Debian installation process is available at `/tmp/grml-debootstrap.log`.

The log file of the deployment process is available at `/tmp/deployment-installer-debug.log`.

The log files of the `ngcp` installer are available at `/mnt/var/log/ngcp-installer.log` as long as the installation is still running or if the installation fails. Once the installation process has been completed successfully the file system of the target system is not mounted any longer so you can't access `/mnt/var/log/ngcp-installer...` any longer by default. But the log files are also available inside `/var/log/` of the installed system so you can access them even after rebooting into the installed system. You can access the log files from the deployment ISO by executing:

```
root@spce ~ # Start lvm2
root@spce ~ # mount /dev/mapper/ngcp-root /mnt
root@spce ~ # ls -l /mnt/var/log/{grml,ngcp}*.log
/mnt/var/log/grml-debootstrap.log
/mnt/var/log/deployment-installer-debug.log
/mnt/var/log/ngcp-installer.log
```

### 3.4.4. Debugging the deployment process

By default the deployment script enables an SSH server with password `sipwise` for users `root` and `grml` so you can login already while deployment is still running (or if it fails).

At the top of the system screen is a logo splash where you should find the IP address of the system so you can ssh to it:

```
192.168.51.2 https://192.168.51.2/qemu/vnc-direct.htm?cid=4&veid=111
Disconnect Options Clipboard Record Send Ctrl-Alt-Del Refresh
+++ Grml-Sipwise Deployment +++
grml64 2011.12 Release Codename Knecht Rootrecht [2011-12-23]
Host IP(s): 192.168.51.111 | Deployment version: 9843
1 CPU(s) | 1027040kB RAM | No physical chassis found

Install ngcp: true | Install pro: false | Install ce: true
Installing <latest> platform using installer version <latest>
Install IP: 192.168.51.111 | Started deployment at Wed Aug 1 15:03:49 CEST 2012
Hit http://d... squeeze/main amd64 Packages
Get:2 http://security.debian.org squeeze/updates Release.gpg [836 B]
Ign http://security.debian.org/ squeeze/updates/contrib Translation-en
```

If you think the problem might be inside the deployment script (which is available as `/tmp/netscript.grml` on the system) itself enable the "debugmode" boot option to run it under "set -x" and enable timestamp tracing. The deployment process log is available at `/tmp/deployment-installer-debug.log`.

### 3.4.5. Custom Installation

The installation and configuration steps are separated. First, the hard disk drive or SSD is partitioned, Debian is bootstrapped and NGCP packages are installed. Then the server is rebooted. Afterwards, it is necessary to run the `ngcp-initial-configuration` tool.

After the reboot you can modify the `/etc/ngcp-installer/config_deploy.inc` file to tune the configuration process.

# Chapter 4. Concept

## 4.1. Contacts

A contact contains information such as the name, the postal and email addresses, and others. A contact's main purpose is to identify entities (resellers, customers, peers and subscribers) it is associated with.

A person or an organization may represent a few entities and it is handy to create a corresponding organization's contact beforehand and use it repeatedly when creating new entities. In this case we suggest populating the **External #** field to distinguish between customers associated with the same contact.

Reseller	Contact	Customer	External #
Default	Rylic Longstaff	DTS	0007
		Morning Times	0008
TelephOne	Clare Fenn	Lantern Co	—
	Ike Leonard	City Bank	—

Note that the only required contact field is **email**. For contacts associated with customers, it will be used for sending invoices and notifications such as password reset, new subscriber creation and others. A contact for a subscriber is created automatically but only if you specify an email address for this subscriber. It is mainly used to send notification messages, e.g. in case of a password reset.

## 4.2. Resellers

The reseller model allows you to expand your presence in the market by including virtual operators in the sales chain. A virtual operator can be a company without its own VoIP platform and even without a technical background, but with sales presence in a market. You define such a company as a reseller in the platform: grant limited access to the administrative web interface (the reseller administrator will only see his own customers, domains and billing profiles) and define wholesale rates for this reseller. Then, the reseller is free to operate under its own brand, make up its retail rates, establish the customer base and resell your services to its customers. The reseller's profit is a margin between the wholesale and retail rates. The platform operator can in turn generate invoices to charge the resellers.

Let us consider an example:

- You operate in Munich and provide residential and business services.
- A company Cheap Call that has a strong presence in Frankfurt offers to resell your services under its own brand in this city.
- You define wholesale rates for Cheap Call, such as calls to Argentina at €0,03.
- Cheap Call defines its retail price and offers calls to Argentina at €0,04.
- When one of Cheap Call's subscribers makes a 5-minute call to Argentina, this subscriber will be charged €0,20.
- You will get €0,15 revenue and Cheap Call's profit will be €0,20 – €0,15 = €0,05.

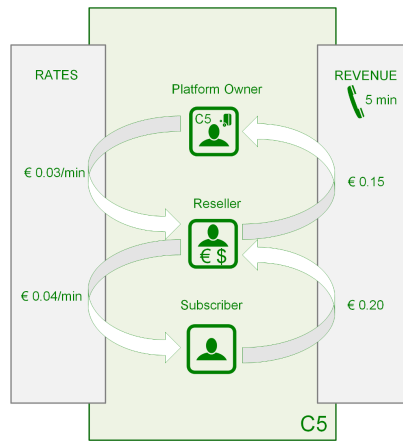

A reseller usually uses dedicated IP addresses or SIP domain names to provide services. Also, a reseller can rebrand the self-care web interface for its customers and select languages per SIP domain that allows the reseller to operate even in multiple countries.

## 4.3. SIP Domain

A SIP domain represents an external Internet address where your subscribers register their SIP phones to make calls or send messages. The SIP domain also contains particular default configuration for all the subscribers registered with this SIP domain. A SIP domain can be a regular FQDN (e.g. sip.yourdomain.com) or a NAPTR/SRV record. Using IP addresses for SIP domains in production is **strongly discouraged**.

### 4.3.1. Additional SIP Domains

You can create as many SIP domains as required to satisfy your networking or marketing requirements, e.g.:

- A dedicated SIP domain is *suggested* per CloudPBX customer.
- A separate SIP domain may be dedicated to every whitelabel reseller.
- Multiple SIP domains may be used to provide services in different countries or regions.
- Multiple SIP domains may be used to brand your own services.

Domain	Purpose
sip.yourdomain.com	Your own domain for retail customers
sip.enterprise.com	Your big customer with Cloud PBX
sip.reseller.com	Your white-label reseller
sip.yourdomain.de	Your domain for providing a new service in another country

## 4.4. Contracts

A contract is a combination of a *contact* and a *billing profile*, hence it represents a business contract for your resellers and peering partners.

Contracts can be created in advance on the *Reseller and Peering Contracts* page, or immediately during creation of a peer or a reseller.

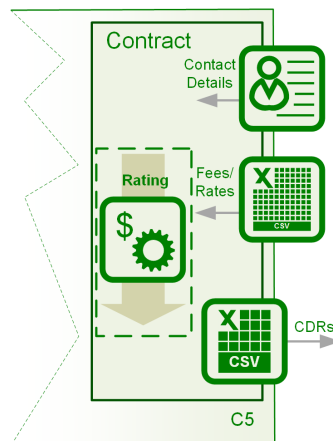

Note that the *customer* entity (described below) is a special type of the contract. A customer entity has an email and an optional invoice template (for batch invoice creation) in addition to a contact and a billing profile.

## 4.5. Customers

A customer is a physical or legal entity whom you provide the VoIP service with and send invoices to. Here are the main features of a customer:

- Contains the contact and legal information. For example, an address or an email address for invoicing.
- Associated with a billing profile (to define fees per destination) and tracks the balance (used mostly for post-paid customers).
- Contains a certain number of subscribers who actually use the service and whose calls appear in the customer's list of CDRs.
- Provides some default parameters for all its subscribers. For example, voice prompts and call restriction.

Here are two common examples of the customer model:

### 4.5.1. Residential and SOHO customers

With this service you provide your residential and SOHO customers with one or multiple numbers and offer the service on a post-paid basis.

For a residential customer you usually create one *customer* entity with one *subscriber* under it. A residential customer can register multiple devices with the same number thus having a convenient Viber or Skype-like service: any device can be used to make a call and all of them will ring simultaneously when there is an incoming call. At the end of the billing period, you send an invoice to the customer.

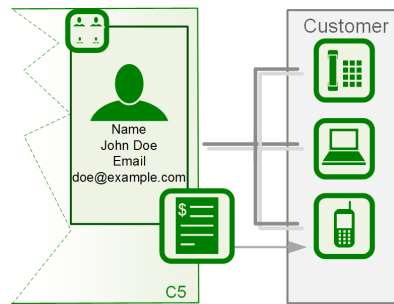

For SOHO customers you usually create multiple subscribers under the same customer and assign every subscriber a dedicated number to allow users make and receive calls. A common invoice will contain calls of all the subscribers.

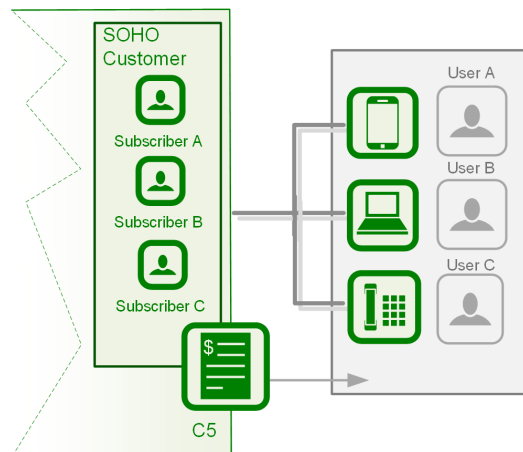

#### 4.5.2. Business customers with the Cloud PBX service

In this case you create a Customer and all the required entities under it to reflect the company's structure: subscribers, extensions, hunt groups, auto-attendant menus, etc.

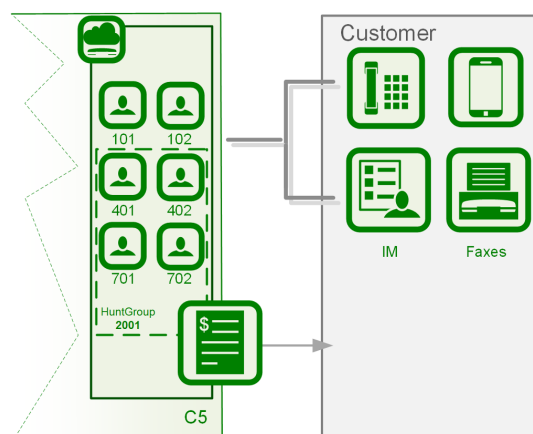

#### 4.5.3. SIP Trunking

If a customer PBX can register itself with Sipwise C5, you create a regular subscriber for it and configure a standard username/password authentication. Multiple PBX users can then send and receive calls.

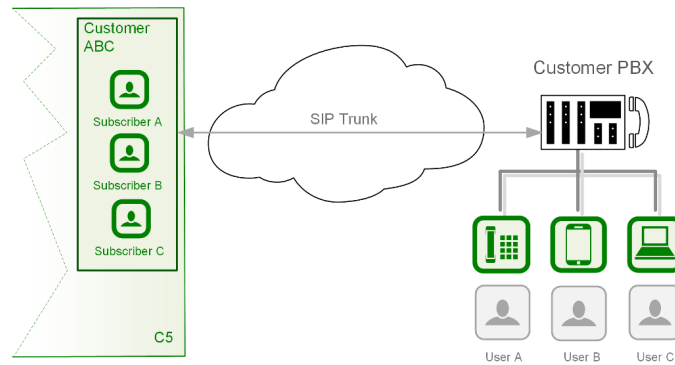

Legacy PBX devices that are not capable of passing the *challenge*-based authentication can be authenticated by the IP address. Optionally, every user of such a PBX can be authenticated separately by the FROM header and the IP address. For more details, refer to the [Trusted Sources](#) section.

#### 4.5.4. Mobile subscribers

The pre-paid model works perfectly for [mobile application users](#). In this case you generally create a single subscriber under a customer.

#### 4.5.5. Pre-paid subscribers who use your calling cards

In this case you will most likely create a single subscriber under a customer, although multiple subscribers would work as well. In the latter case, they will share and top-up the common balance. Notice that the *customer* entity itself does not contain any technical configuration for the VoIP service authentication and instead contains other entities called *subscribers*, which do.

## 4.6. Subscribers

Every subscriber represents a SIP line or a SIP trunk. For example, in the residential services a subscriber entity is dedicated to every user. In the SIP trunking scenario, a subscriber can be used to authenticate all VoIP traffic from the remote PBX device.

In the following table logical subscriber types and their purpose are described.

Service	Subscriber Type	Purpose	Features
Residential	Regular subscriber	A regular VoIP service	Requires a DID number to receive calls from outside of your network
Enterprise (CloudPBX)	Pilot subscriber	A base number for the enterprise customer; Lists all extra numbers (aliases)	Configures the rest of customer subscribers in its self-care web interface
	Extension	Extra numbers (DIDs, "implicit" extensions) for the enterprise customer	Can be dialed in different ways; The number configuration builds on top of the Pilot subscriber
	PBX Group	Forwards incoming calls to multiple extensions	Ringling policy defines in which order the extensions will ring

Service	Subscriber Type	Purpose	Features
SIP Trunk	Digest authentication	Dynamically registers a remote IP PBX device	Handles multiple users behind the IP PBX device
	IP authentication	IP authentication of legacy IP PBX devices incapable of registering with the platform	Might require Trusted Subscriber and Trusted Source configuration
Prepaid	Regular subscriber with prepaid billing profile	Authorization of services based on customer balance; Disconnection of calls on "zero balance"	<a href="#">Vouchers</a> and <a href="#">Balance Top-Up, Profile Packages</a>

**TIP** | Subscriber **Aliases** can provide Extra DIDs or extension numbers to a subscriber.

## 4.7. SIP Peerings

A SIP peering is your interconnection with the external VoIP or PSTN network. Usually, a VoIP service provider has at least a few termination partners to offer its subscribers calls to virtually any landline and mobile destination.

SIP peerings also enable incoming calls to your platform. For example, if you rent a pool of DID numbers from a SIP peer and offer them to your residential and business customers.

An interconnection with your termination partners and DID number providers can include multiple servers and enable both outbound and inbound calls, hence such a configuration is called a *SIP peering group*. You configure at least one SIP peering group for every partner and the main principle here is that all servers in a group terminate calls to the same set of listed destinations.

Any SIP peering group includes two main technical configurations:

- Peering Servers Represent connections to/from your SIP peering's network. The parameters include an IP address and/or a hostname of the remote part. For outbound calls, this is the destination address where to send calls to and for inbound calls it is an IP authorization of the remote server.
- Outbound/Inbound Peering Rules Outbound rules define through which SIP peering group a call from a specific subscriber will be sent for termination to a specific destination.

The peering group is associated with a *contract* for reconciliation and billing. Peer invoices can be generated to audit the costs that peering partners are charging the platform operator.

The example below shows four SIP peering groups with different priorities, callee prefixes (actual destinations offered by this SIP peering) and callee / called patterns (fine-tuning which callee request URIs and caller URIs are allowed through this SIP peering group).

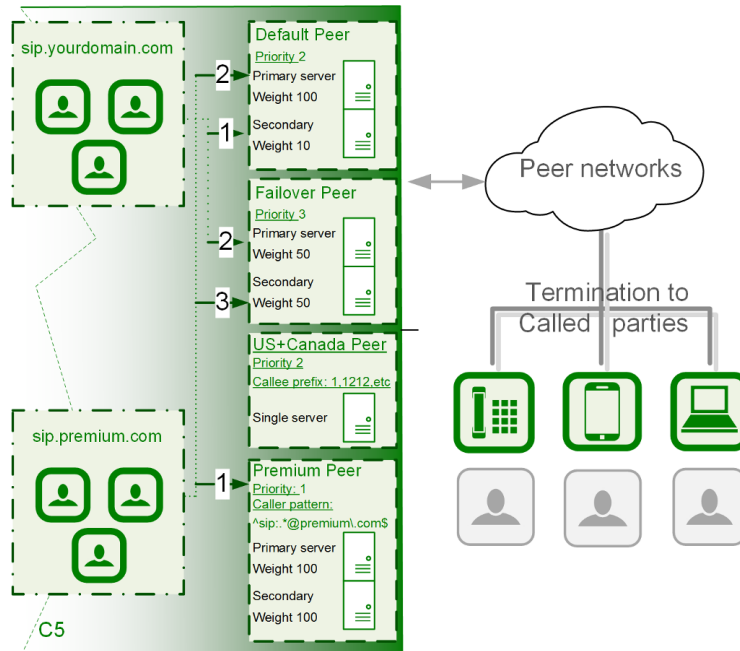

The figure shows how calls from premium subscribers can in the first place be routed through a dedicated SIP peering group unavailable to regular subscribers.

See the [Routing Order Selection](#) section for details about call routing.

Inbound rules allow [filtering out incoming INVITE requests](#) arriving from the corresponding SIP peering servers.

# Chapter 5. Kick-off

A basic VoIP service configuration is fast, easy and straight-forward. Provided that your network and required DNS records have been preconfigured, the configuration of a VoIP service can be done purely via the administrative web interface. The configuration mainly includes the following steps:

- Reseller creation (optional)
- SIP domain configuration
- Customer creation
- Subscribers provisioning

Let us assume you are using the `203.0.113.42` IP address with an associated `sip.yourdomain.com` domain to provision VoIP services. This allows you to provide an easy-to-remember domain name instead of the IP address as the proxy server. Also, your subscribers' URIs will look like `1234567@sip.yourdomain.com`.

**TIP**

Using an IP address instead of an associated FQDN (domain name) for a SIP domain is not suggested as it could add extra administrative work if you decide to relocate your servers to another datacenter or change IP addresses.

Go to the *Administrative Web Panel (Admin Panel)* running on <https://<ip>:1443/> and follow the steps below. The default web panel user and password are *administrator*, if you have not already changed it.

## 5.1. Creating a SIP Domain

A SIP domain is a connection point for your subscribers. The SIP domain also contains specific default configuration for all its subscribers.

**TIP**

Thoroughly plan your domain names policy in advance and take into account that: 1) the name of a SIP domain cannot be changed after creating it in the administrative web panel; 2) subscribers cannot be moved from one domain to another and must be recreated.

To create a SIP domain, follow these steps:

1. Firstly, configure an FQDN on your DNS server for it.

The domain name must point to the physical IP address you are going to use for providing the VoIP service. A good approach is to create an SRV record:

```
SIP via UDP on port 5060
SIP via TCP on port 5060
SIP via TCP/TLS on port 5061
```

2. Create a new SIP domain in the administrative web panel.

Go to the *Domains* page and create a new SIP Domain using the FQDN created above.

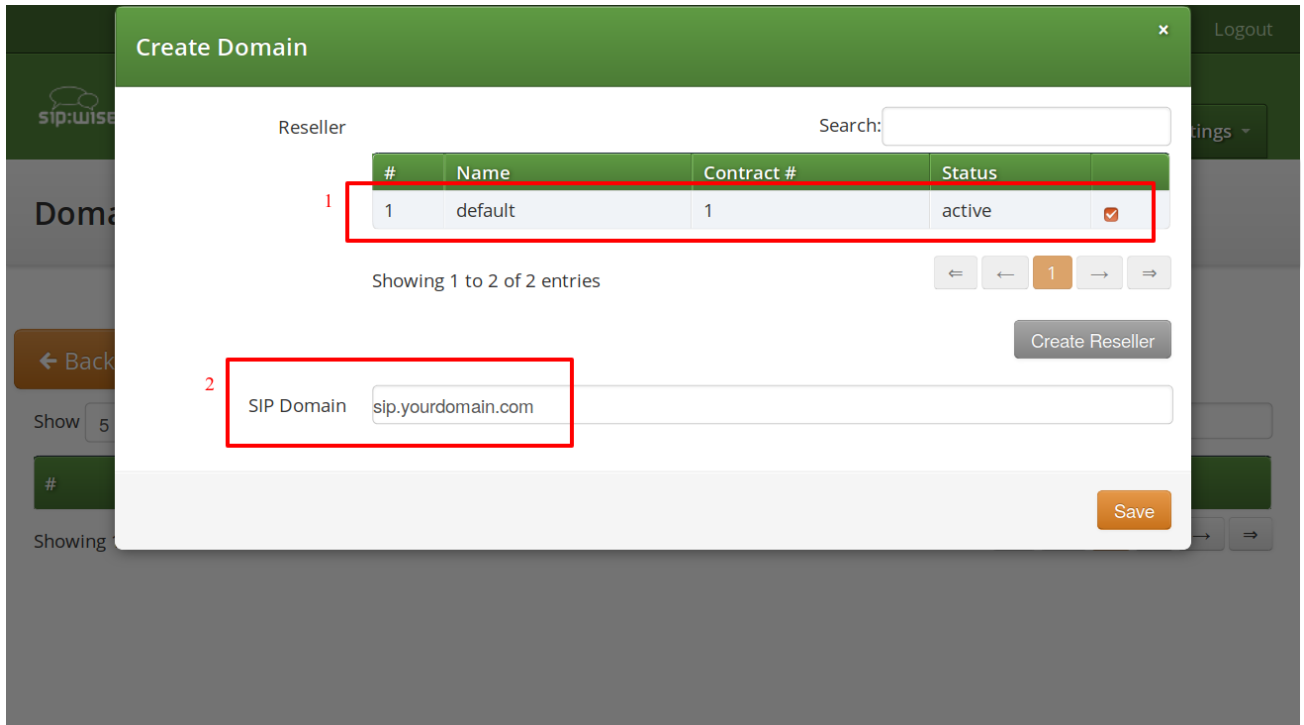

Select a *Reseller* who will own the subscribers in this SIP domain. Use the *default* virtual reseller if you provide services directly. Enter your SIP domain name and press *Save*.

- Adjust the new SIP domain's preferences if necessary.

You can create multiple SIP domains reusing the existing IP address or adding a new one. Extra SIP domains are required e.g. if you would like to host a virtual operator on your platform, create separate domains for providing services in different countries or offer a new service.

## 5.2. Creating a Customer

A Customer is a special type of contract acting as legal and billing information container for SIP subscribers. A customer can have one or more SIP subscriber entities that represent SIP lines.

### TIP

For correct billing, notification and invoicing, create a customer with a single SIP subscriber for the residential service (as it normally has only one telephone line) and a customer with multiple SIP subscribers to provide a service to a company with many telephone lines.

To create a Customer, go to *SettingsCustomers*.

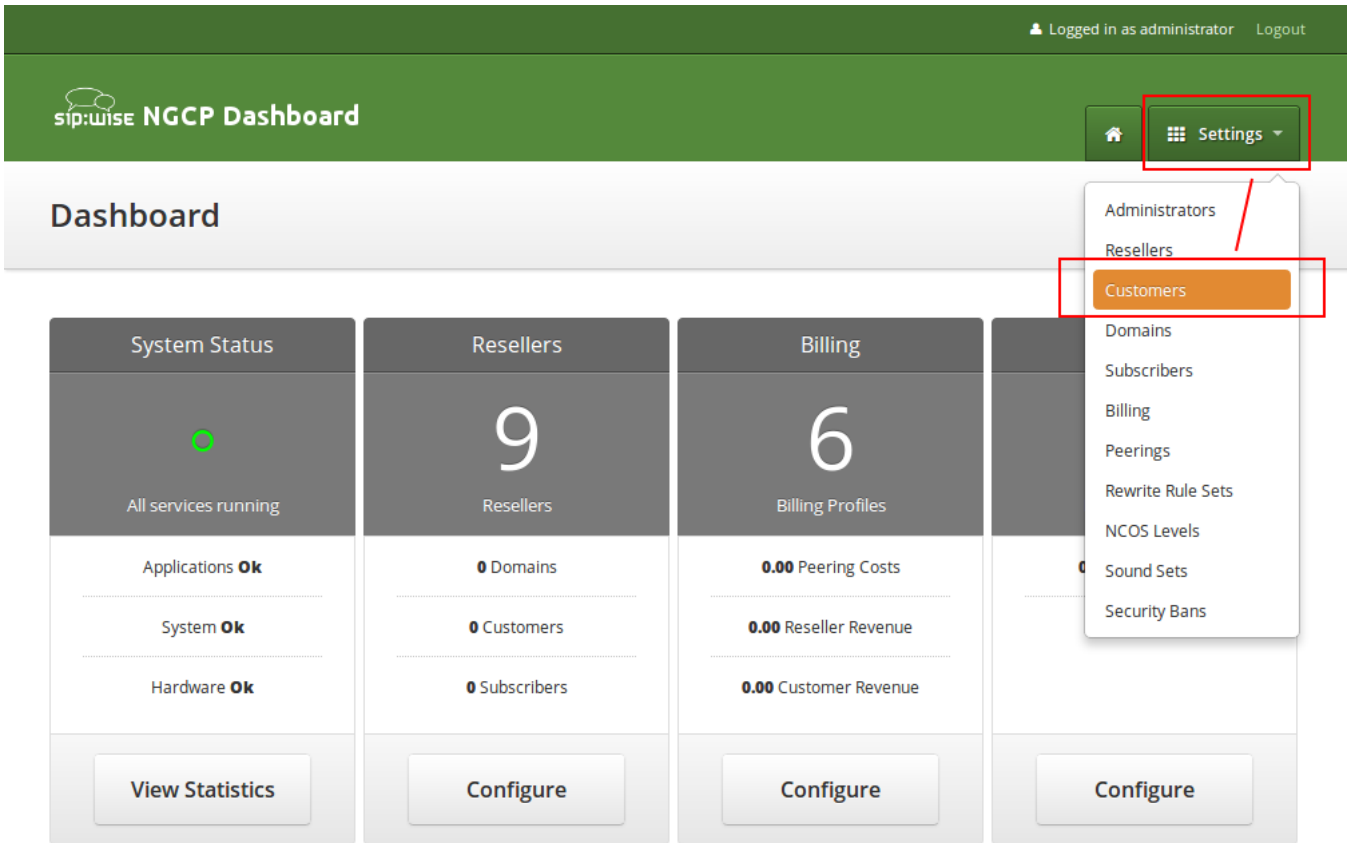

Click on *Create Customer*.

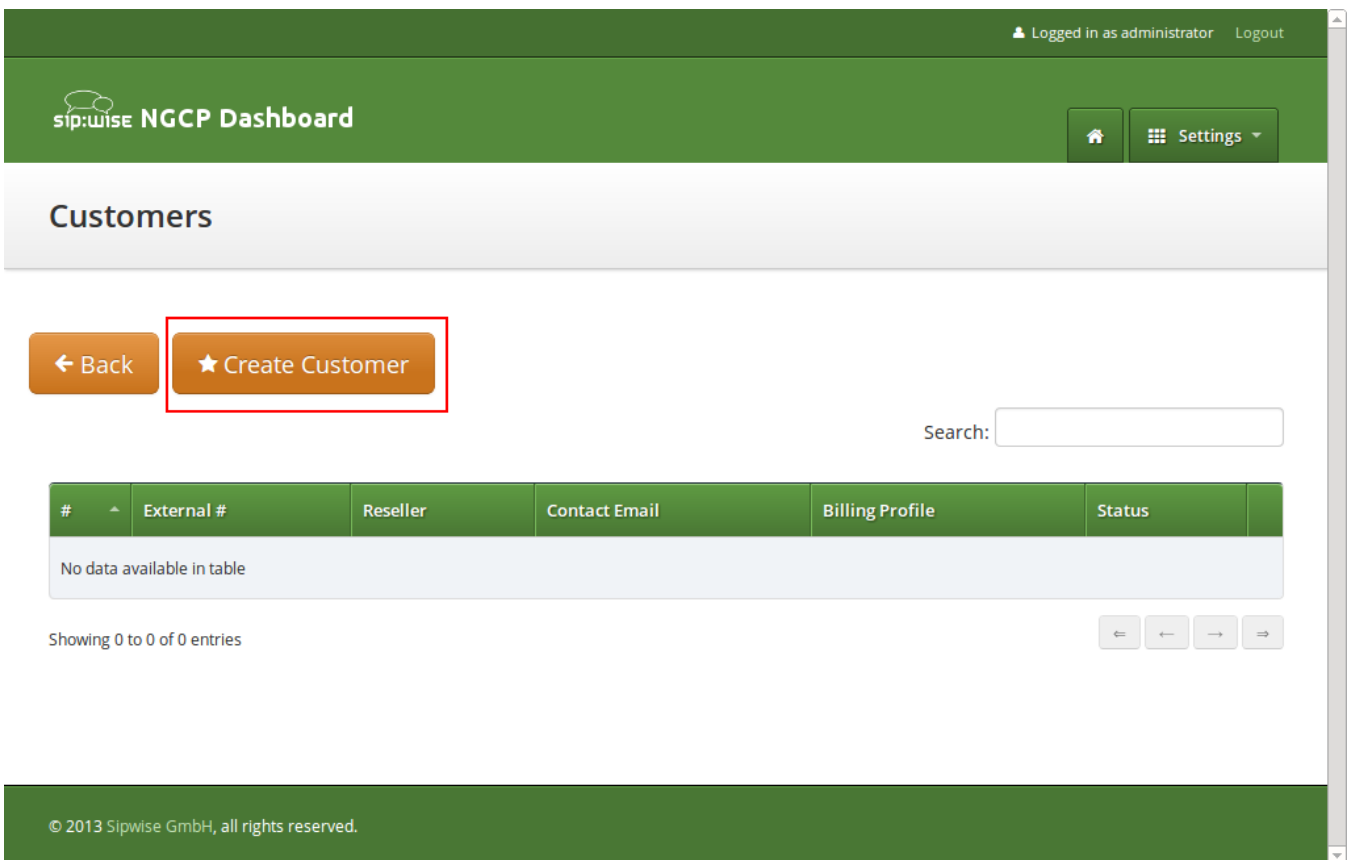

Each *Customer* has a *Contact*—a container for the personal and legal information that identifies a private

or corporate customer.

**TIP**

Create a dedicated *Contact* for every *Customer* as it contains specific data e.g. name, address and IBAN that identifies this customer.

Click on *Create Contact* to create a new *Contact*.

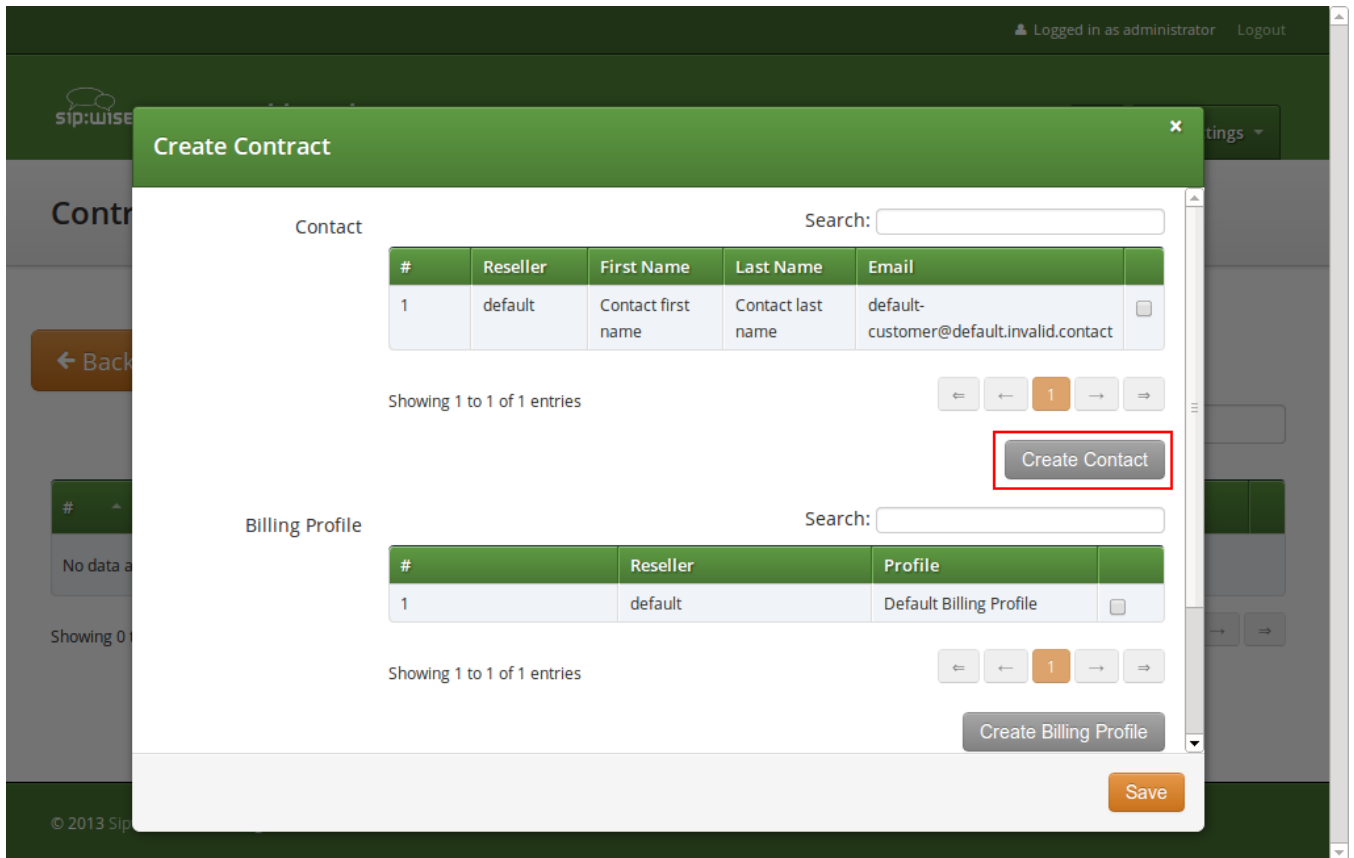

Select the required *Reseller* and enter the contact details (at least an *Email* is required), then press *Save*.

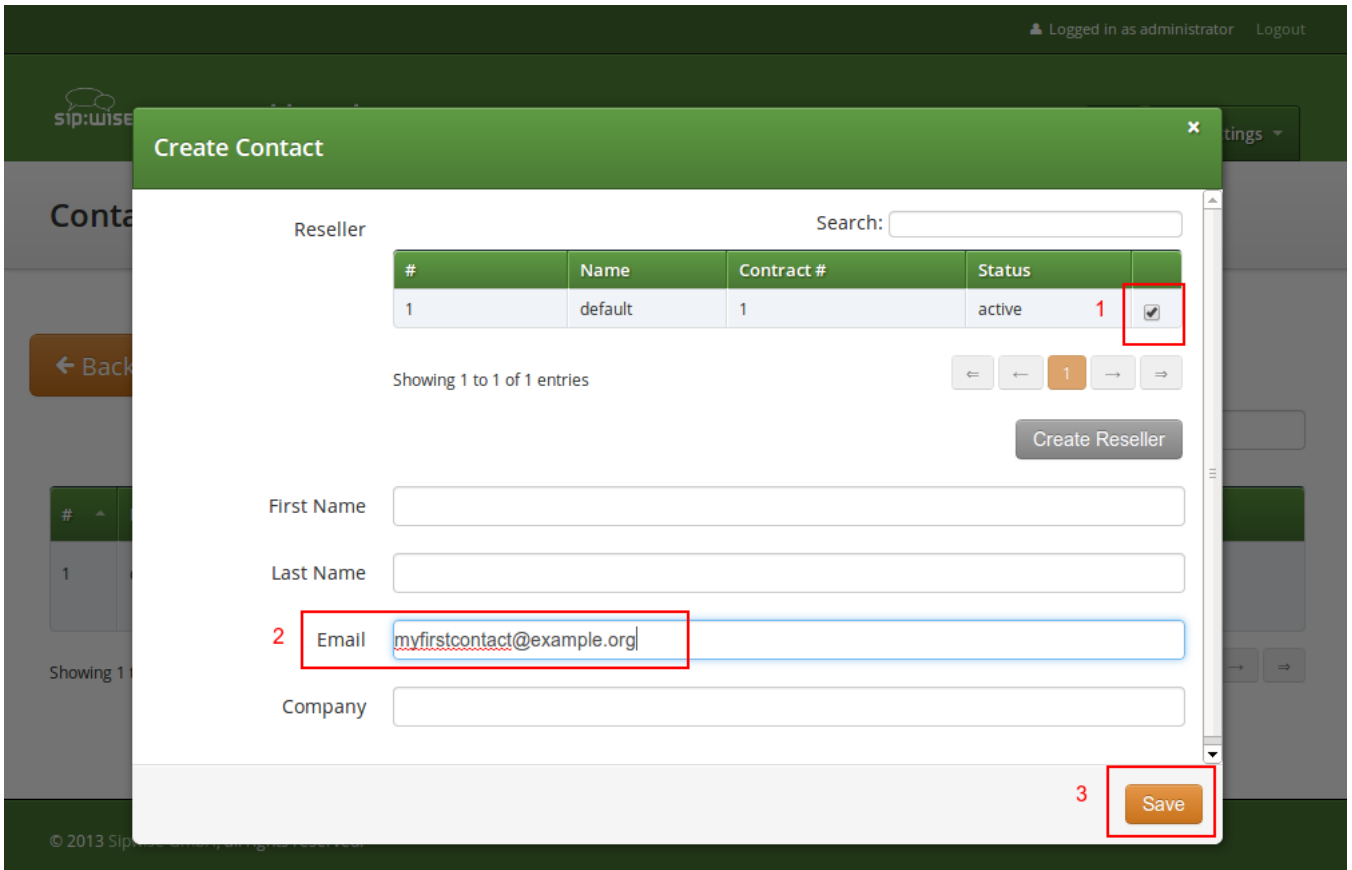

You will be redirected back to the *Customer* form. The newly created *Contact* is selected by default now, so only select a *Billing Profile* and press *Save*.

You will now see your first *Customer* in the list. Hover over the customer and click *Details* to make extra configuration if necessary.

The screenshot shows the Sipwise NGCP Dashboard interface. At the top right, it indicates the user is logged in as an administrator with a 'Logout' link. The dashboard title is 'sip:wise NGCP Dashboard'. Below the title bar, there are navigation buttons for 'Home' and 'Settings'. The main heading is 'Customers'. There are two orange buttons: 'Back' and 'Create Customer'. A green notification bar states 'Contract successfully created'. A search bar is present. Below is a table with one entry. The 'Details' button for this entry is highlighted with a red box. At the bottom, it shows 'Showing 1 to 1 of 1 entries' and pagination controls.

Logged in as administrator Logout

sip:wise NGCP Dashboard

Home Settings

## Customers

Back Create Customer

Contract successfully created

Search:

#	External #	Reseller	Contact Email	Billing Profile	Status	
20		default	myfirstcontact@example.org	Default Billing Profile	active	<a href="#">Edit</a> <a href="#">Terminate</a> <a href="#">Details</a>

Showing 1 to 1 of 1 entries

## 5.3. Creating a Subscriber

In your *Customer* details view, click on the *Subscribers* row, then click *Create Subscriber*.

Logged in as administrator Logout

sip:wise NGCP Dashboard

Customer Details

← Back Edit

Reseller

Contact Details

Billing Profiles

1 Subscribers

★ Create Subscriber 2

SIP URI	Primary Number	Registered Devices
---------	----------------	--------------------

Contract Balance

Select a *SIP Domain* created earlier and specify required and optional parameters:

- **Domain:** The domain part of the SIP URI for your subscriber.
- **E164 Number:** This is the telephone number mapped to the subscriber, separated into *Country Code (CC)*, *Area Code (AC)* and *Subscriber Number (SN)*. For the first tests, you can set an imaginary number here and change it later when you get number blocks assigned by your PSTN interconnect partner. So in our example, we'll use *43* as CC, *99* as AC and *1001* as SN to form the imaginary number *+43 99 1001*.

#### TIP

This number can actually be used to place calls between local subscribers, even if you don't have any PSTN interconnection. This comes in handy if you use phones instead of soft-clients for your tests. The format in which this number can be dialed, so the subscriber is reached is defined in [Configuring Rewrite Rule Sets](#).

#### IMPORTANT

Sipwise C5 allows a single subscriber to have multiple E.164 numbers to be used as aliases for receiving incoming calls. Also, Sipwise C5 supports so-called "implicit" extensions. If a subscriber has phone number 012345, but somebody calls 012345100, then NGCP first tries to send the call to number 012345100 (even though the user is registered as 012345). If Sipwise C5 then receives the 404 - Not Found response, it falls back to 012345 (the user-part with which the callee is registered).

- **Email:** An email address for sending service-related notifications to.
- **Web Username:** This is the user part of the username the subscriber may use to log into her *Customer Self Care Interface*. The user part will be automatically suffixed by the SIP domain you choose for the **SIP URI**. Usually, the web username is identical to the **SIP URI**, but you may choose a different naming schema.

**CAUTION**

The web username needs to be unique. The system will return a fault if you try to use the same web username twice.

- **Web Password:** This is the password for the subscriber to log into her *Customer Self Care Interface*. It must be at least 6 characters long.
- **SIP Username:** The user part of the SIP URI for your subscriber.
- **SIP Password:** The password of your subscriber to authenticate on the SIP proxy. It must be at least 6 characters long.
- **Status:** You can lock a subscriber here, but for creating one, you will most certainly want to use the *active* status.
- **External ID:** You can provision an arbitrary string here (e.g. an ID of a 3rd party provisioning/billing system).
- **Administrative:** If you have multiple subscribers in one account and set this option for one of them, this subscriber can administrate other subscribers via the *Customer Self Care Interface*.

Domain Search:

#	Reseller	Domain
1 113	default	sip.yourdomain.com <input checked="" type="checkbox"/>

Showing 1 to 1 of 1 entries

2 E164 Number

3 Email

4 Web Username

5 Web Password

Save

The screenshot shows the 'Create Subscriber' modal in the Sipwise NGCP Dashboard. The form contains the following fields and values:

- Web Username: demo
- Web Password: secret
- SIP Username: demo (highlighted with a red box and labeled '6')
- SIP Password: 1secret! (highlighted with a red box and labeled '7')
- Lock Level: none
- Status: active
- External ID: demo
- Administrative:

A 'Save' button is located at the bottom right of the modal.

Repeat the creation of *Customers* and *Subscribers* for all your test accounts. You should have at least 3 subscribers to test the functionality of the NGCP.

**TIP**

At this point, you're able to register your subscribers to Sipwise C5 and place calls between these subscribers.

You should now revise the *Domain* and *Subscriber* Preferences.

## 5.4. Domain Preferences

The *Domain Preferences* are the default settings for *Subscriber Preferences*, so you should set proper values there if you don't want to configure each subscriber separately. You can later override these settings in the *Subscriber Preferences* if particular subscribers need special settings. To configure your *Domain Preferences*, go to *SettingsDomains* and click on the *Preferences* button of the domain you want to configure.

Logged In as administrator Language Logout

sip:wise NGCP Dashboard

Documentation Monitoring & Statistics Tools Settings

## Domains

← Back ★ Create Domain

Show 5 entries Search:

#	Reseller	Domain	
113	default	sip.yourdomain.com	Delete Preferences

Showing 1 to 1 of 1 entries

← 1 →

The most important settings are in the *Number Manipulations* group.

Here you can configure the following:

- for incoming calls - which SIP message headers to take numbers from
- for outgoing calls - where in the SIP messages to put certain numbers to
- for both - how these numbers are normalized to E164 format and vice versa

To assign a *Rewrite Rule Set* to a *Domain*, create a set first as described in [Configuring Rewrite Rule Sets](#), then assign it to the domain by editing the *rewrite\_rule\_set* preference.

## Domain "sip.yourdomain.com" - Preferences

← Back

Call Blockings

Access Restrictions

1 Number Manipulations

	Name	Value	
?	rewrite_rule_set	<input type="text"/>	2 <input type="button" value="Edit"/>
?	extension_in_npn	<input type="checkbox"/>	
?	inbound_upn	From-Username	
?	outbound_from_user	User-Provided-Number	
?	outbound_from_display	None	

Select the *Rewrite Rule Set* and press *Save*.

Logged in as administrator Logout

sip:wise

Domain

1

2

Save

← Back

Call Blockings

Access Restrictions

Number Manipulations

	Name	Value	
?	rewrite_rule_set	<input type="text"/>	
?	extension_in_npn	<input type="checkbox"/>	
?	inbound_upn	From-Username	

Then, select the field you want the *User Provided Number* to be taken from for inbound INVITE

messages. Usually the *From-Username* should be fine, but you can also take it from the *Display-Name* of the From-Header, and other options are available as well.

## 5.5. Subscriber Preferences

You can override the *Domain Preferences* on a subscriber basis as well. Also, there are *Subscriber Preferences* which don't have a default value in the *Domain Preferences*.

To configure your *Subscriber*, go to *SettingsSubscribers* and click *Details* on the row of your subscriber. There, click on the *Preferences* button on top.

You want to look into the *Number Manipulations* and *Access Restrictions* options in particular, which control what is used as user-provided and network-provided calling numbers.

- For outgoing calls, you may define multiple numbers or patterns to control what a subscriber is allowed to send as user-provided calling numbers using the *allowed\_clis* preference.
- If *allowed\_clis* does not match the number sent by the subscriber, then the number configured in *cli* (the network-provided number) preference will be used as user-provided calling number instead.
- You can override any user-provided number coming from the subscriber using the *user\_cli* preference.

### NOTE

Subscribers preference *allowed\_clis* will be synchronized with subscribers primary number and aliases if *ossbssprovisioningauto\_allow\_cli* is set to **1** in */etc/ngcp-config/config.yml*.

### NOTE

Subscribers preference *cli* will be synchronized with subscribers primary number if *ossbssprovisioningauto\_sync\_cli* is set to **yes** in */etc/ngcp-config/config.yml*.

### 5.5.1. Subscriber authentication for outbound calls

There are cases when Sipwise C5 should pass the authentication process for a subscriber. In other words to pass the authentication process of an outbound call from behalf of the subscriber entity (configuration object).

Suppose there is Sipwise C5 and some other Class 5 system (can be just another Sipwise C5). You have recently migrated part of subscribers from another Class 5 system to Sipwise C5. But, you still have SIP peerings (with ITSPs) at that system, and you would like that recently migrated subscribers are still able to terminate calls via that another Class 5 system.

This is when the 'Remote Authentication' parameters start helping you. The call flow in this scenario will be: *Sipwise C5another Class 5 systemSIP peering*

And that system (another Class 5 system) will of course treat a call coming to it from Sipwise C5, as if that would be a direct call from the subscriber (indeed it's not).

This is when you need to be capable of the authentication and Sipwise C5 gives you this possibility.

You will need to go to subscriber's preferences and to know specific credentials to be used for that, in order to pass the authorization. To configure this setting, open the *Remote Authentication* tab and edit the following four preferences:

- **peer\_auth\_user:** <username for peer auth>

- **peer\_auth\_pass:** <password for peer auth>
- **peer\_auth\_realm:** <domain for peer auth>
- **peer\_auth\_registrar\_server:** <domain for registrar server>
- **peer\_auth\_hf\_user:** <username parameter for Authorization hf>

The 'peer\_auth\_hf\_user' preference is optional and can be skipped. It allows you to set a specific username for the Proxy-Authorization header. The 'peer\_auth\_registrar\_server' is also optional. In case it is not set, the REGISTER will be sent to the 'peer\_auth\_realm' domain. In case there is a scenario where the realm is different from the registrar server domain/IP, the 'peer\_auth\_registrar\_server' can be set. In this case the REGISTER will be sent there and the 'peer\_auth\_realm' used only as Digest Realm.

As soon as you define those parameters, a call from behalf of the subscriber, which will be terminated at another system, can be successfully authenticated.

### 5.5.2. Subscriber authentication for an outbound registration

This is approximately the same use case as for the 'Subscriber authentication for outbound calls' section, but this time for the registration process. Sipwise C5 can register at remote system, hence placing the location record on behalf of the subscriber.

**NOTE** Location record which will be saved at a remote system, will contain the contact of Sipwise C5 Load-Balancer, not the contact of the end subscriber.

The reason why you might need Sipwise C5 to register at remote system from behalf of the subscriber:

- you want to receive calls from remote system to your subscriber, as if your subscriber would receive this directly;
- that remote system doesn't accept a call sent from Sipwise C5 from behalf of the subscriber, without a registration beforehand;

**NOTE** This registration process will be completely independent from the end subscriber, and will be only triggered and controlled by Sipwise C5.

This is when the 'Remote Authentication' parameters help you again. You need to go to subscriber's preferences, open the *Remote Authentication* tab and now additionally enable outbound registration:

- **peer\_auth\_register:** *True*

Now in common with the preferences you defined previously in the 'Subscriber authentication for outbound calls' section, the registration process will start using given credentials.

**IMPORTANT** Remember, the subscriber's preference 'peer\_auth\_hf\_user' affects invitation scenarios, as well as registration scenarios. Hence in case you set it, the username during digest, will be swapped.

### 5.5.3. Subscriber's preference for media in terms of IP Family (IPv4/IPv6)

It is possible to define which IP Family is preferred by a particular subscriber for sending media (RTP/RTCP), using the following preference:

*NAT and Media Flow Control* `ipv4_for_rtp_proxy`, which can be set to:

- **Force IPv4** - the subscriber prefers to send the media flow via IPv4
- **Force IPv6** - the subscriber prefers to send the media flow via IPv6
- **Auto-detect** - auto detection is enabled and depending on the IP Family used during the registration, the preference for media will be picked out accordingly
- **use domain default** - preference is inherited from the domain values

Both the domain and subscriber preferences contain the *NAT and Media Flow Control* section, which gives an access to the *ipv46\_for\_rtpproxy* preference.

### TIP

It is not necessarily, but is however recommended to set *ipv46\_for\_rtpproxyForce IPv6* for those subscribers which use IPv6 to send media (RTP/RTCP).

## 5.6. Creating Peerings

If you want to terminate calls at or allow calls from 3<sup>rd</sup> party systems (e.g. PSTN gateways, SIP trunks), you need to create SIP peerings for that. To do so, go to *SettingsPeerings*. There you can add peering groups, and for each peering group add peering servers and rules controlling which calls are routed over these groups. Every peering group needs a peering contract for correct interconnection billing.

### 5.6.1. Creating Peering Groups

Click on *Create Peering Group* to create a new group.

In order to create a group, you must select a peering contract. You will most likely want to create one contract per peering group.

The screenshot shows the 'Create SIP Peering Groups' modal in the Sipwise web interface. At the top, it says 'Logged in as administrator' and 'Logout'. The modal title is 'Create SIP Peering Groups'. Below the title, there is a 'Contract' section with a search bar. A table is displayed with the following columns: '#', 'Status', and 'Billing Profile'. The table content is 'No data available in table'. Below the table, it says 'Showing 0 to 0 of 0 entries' and has navigation arrows. A 'Create Contract' button is highlighted with a red box. Below the table, there are input fields for 'Name', 'Priority' (set to 1), and 'Description'. At the bottom right of the modal is a 'Save' button. The footer of the page says '© 2013 Sipwise GmbH, all rights reserved.'

Click on *Create Contract* create a *Contact*, then select a *Billing Profile*.

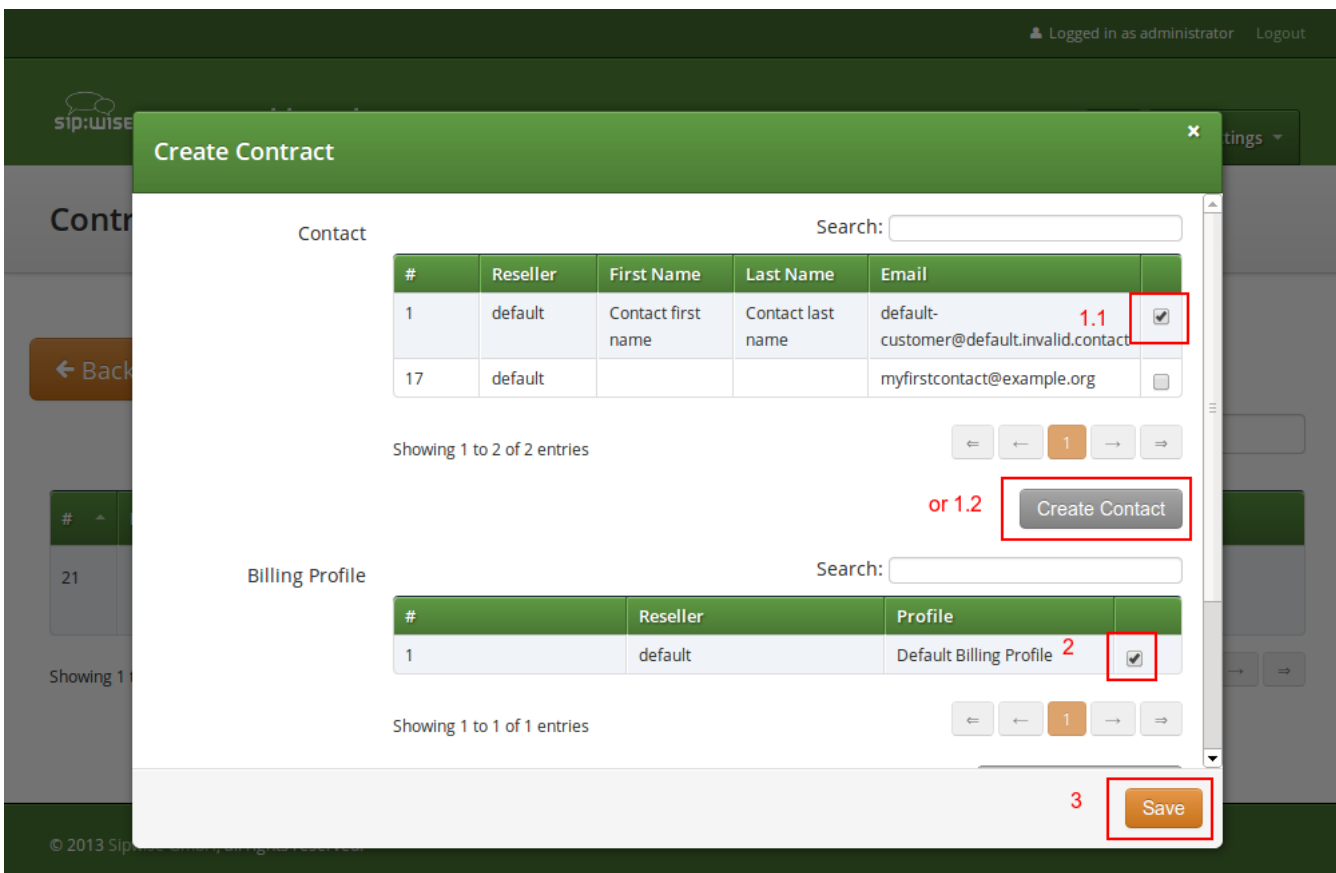

Click *Save* on the *Contacts* form, and you will get redirected back to the form for creating the actual *Peering Group*. Put a name, priority and description there, for example:

- **Peering Contract:** select the id of the contract created before
- **Name:** test group
- **Priority:** 1
- **Description:** peering to a test carrier

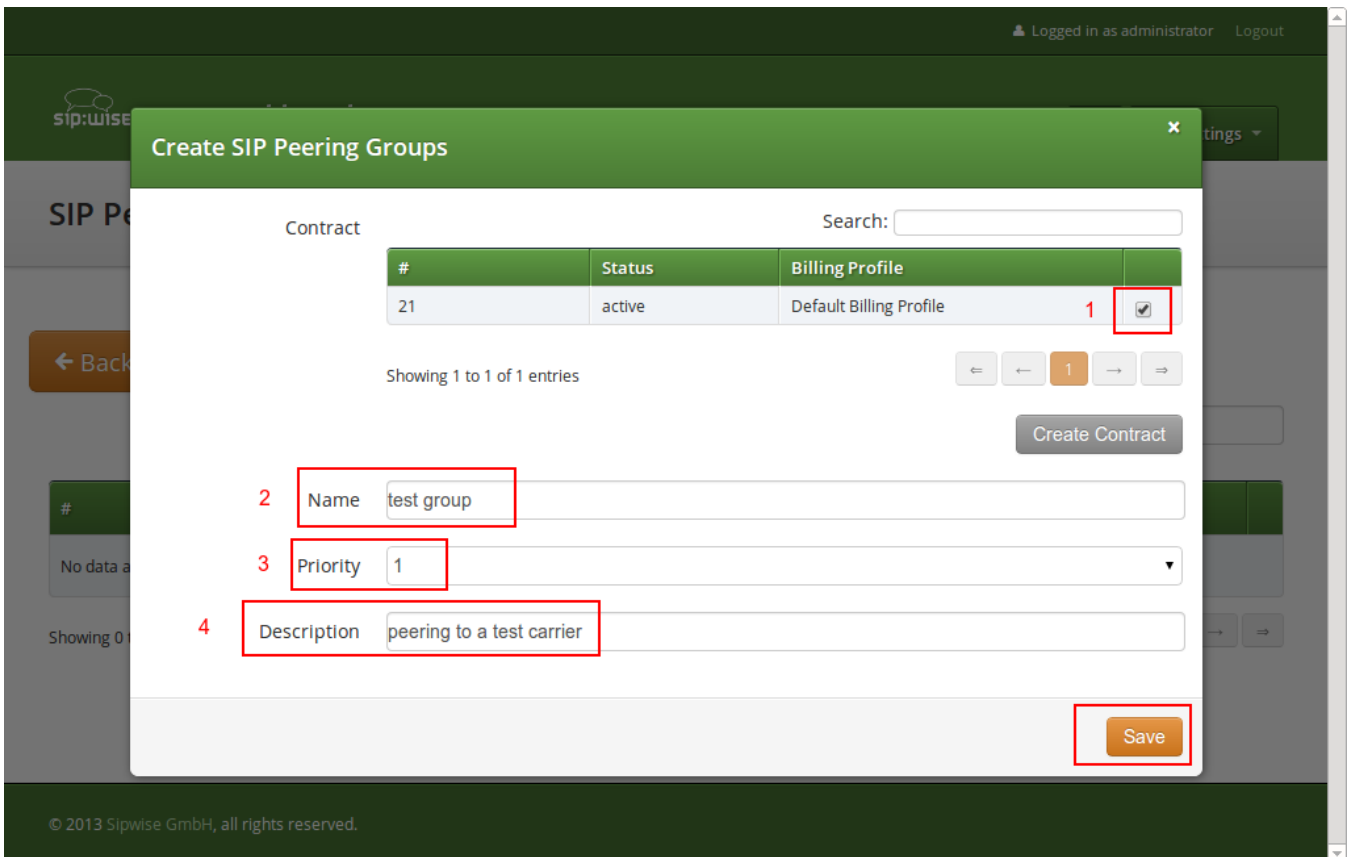

The *Priority* option defines which *Peering Group* to favor (Priority **1** gives the highest precedence) if two peering groups have peering rules matching an outbound call. *Peering Rules* are described below.

Then click *Save* to create the group.

### 5.6.2. Creating Peering Servers

In the group created before, you need to add peering servers to route calls to and receive calls from. To do so, click on *Details* on the row of your new group in your peering group list.

To add your first *Peering Server*, click on the *Create Peering Server* button.

**Peering Servers**

← Back **★ Create Peering Server**

Show 5 entries Search:

#	Name	IP Address	Hostname	Port	Protocol	Weight	Via Route Set	Enabled
No data available in table								

Showing 0 to 0 of 0 entries

**Outbound Peering Rules**

ANY of the rules must match to choose the peering group for outbound calls.

**★ Create Outbound Peering Rule**

Show 5 entries Search:

#	Caller Prefix	Callee Pattern	Caller Pattern	Description	Enabled
No data available in table					

Showing 0 to 0 of 0 entries

**Inbound Peering Rules**

ALL of the rules must match to choose the peering group for inbound calls.

**★ Create Inbound Peering Rule**

Show 5 entries Search:

Priority	#	Field	Pattern	Reject Code	Reject Reason	Enabled
No data available in table						

Showing 0 to 0 of 0 entries

Figure 11. Create Peering Server

In this example, we will create a peering server with IP `203.0.113.42` and port `5060`:

- **Name:** test-gw-1
- **IP Address:** 203.0.113.42
- **Hostname:** leave empty
- **Port:** 5060
- **Protocol:** UDP
- **Weight:** 1
- **Via Route:** None
- **Enable Probing:** enable it, if remote side supports SIP OPTIONS ping

The screenshot shows a 'Create Peering Server' dialog box with the following fields and values:

- Name: test-gw-1
- IP Address: 2.3.4.5
- Hostname: (empty)
- Port: 5060
- Protocol: UDP
- Weight: 1
- Via Route: None
- Enabled:

A 'Save' button is located at the bottom right of the dialog, circled in red.

Figure 12. Peering Server Properties

Click *Save* to create the peering server.

**TIP**

The *hostname* field for a peering server is optional. Usually, the IP address of the peer is used as the **domain** part of the Request URI. Fill in this field if a peer requires a particular hostname instead of the IP address. The IP address must always be given though as it is used for the selection of the inbound peer. By default outbound requests will always be sent to the specified IP address, no matter what you put into the *hostname* field. If you want to send the request using the DNS resolution of the configured *hostname*, disregarding in that way the IP, you have to enable `outbound_hostname_resolution` option in peer preferences.

**TIP**

If you want to add a peering server with an IPv6 address, enter the address without surrounding square brackets into the *IP Address* column, e.g. `::1`.

You can force an additional hop (e.g. via an external SBC) towards the peering server by using the *Via Route* option. The available options you can select there are defined in `/etc/ngcp-config/config.yml`, where you can add an array of SIP URIs in `kamailiolbexternal_sbc` like this:

```
kamailio:
  lb:
    external_sbc:
      - sip:192.168.0.1:5060
      - sip:192.168.0.2:5060
```

Execute `ngcpcfg apply "added external sbc gateways"`, then edit your peering server and select the hop from the *Via Route* selection.

Once a peering server has been created, this server can already send calls to the system.

**NOTE**

Requests coming from a SIP peering are matched not only by the IP address and a transport protocol, but also using the source port of a message. This means, if your SIP peering server created at Sipwise C5 has the 'Port' value set to '5060', then it's expected that messages (requests) coming from this SIP peering, will have the source port '5060'. This however applies only to the UDP transport based connections (TCP and TLS are matched only using an IP address and a transport protocol).

**Outbound Peering Rules****IMPORTANT**

To be able to send outbound calls towards the servers in the *Peering Group*, you also need to define *Outbound Peering Rules*. They specify which source and destination numbers are going to be terminated over this group. To create a rule, click the *Create Outbound Peering Rule* button.

**Peering Servers**

← Back   ★ Create Peering Server

Peering server successfully created

Show 5 entries   Search:

#	Name	IP Address	Hostname	Port	Protocol	Weight	Via Route Set	Enabled
29	test-gw-1	2.3.4.5		5060	1	1		1

Showing 1 to 1 of 1 entries

**Outbound Peering Rules**

ANY of the rules must match to choose the peering group for outbound calls.

★ Create Outbound Peering Rule

Show 5 entries   Search:

#	^	Callee Prefix	Callee Pattern	Caller Pattern	Description	Enabled
No data available in table						

Showing 0 to 0 of 0 entries

**Inbound Peering Rules**

ALL of the rules must match to choose the peering group for inbound calls.

★ Create Inbound Peering Rule

Figure 13. Create Outbound Peering Rule

Since the previously created peering group will be the only one in our example, we have to add a default rule to route *all* calls via this group. To do so, create a new peering rule with the following values:

- **Callee Prefix:** leave empty
- **Callee Pattern:** leave empty

- **Caller Pattern:** leave empty
- **Description:** Default Rule
- **Stopper:** leave empty

Figure 14. Outbound Peering Rule Properties

Then click *Save* to add the rule to your group.

**TIP**

In contrast to the callee/caller pattern, the callee prefix has a regular alphanumeric string and can not contain any regular expression.

**TIP**

If you set the caller or callee rules to refine what is routed via this peer, enter all phone numbers in full E.164 format, that is <cc><ac><sn>.

**TIP**

The *Caller Pattern* field covers the whole URI including the subscriber domain, so you can only allow certain domains over this peer by putting for example @example\.com into this field.

## Inbound Peering Rules

Sipwise C5 supports filtering SIP INVITE requests sent by SIP peers. The system administrator may define one or more matching rules for SIP URIs that are present in the headers of SIP INVITE requests, and select which SIP header (or part of the header) must match the pattern declared in the rule.

If the incoming SIP INVITE message has the proper headers, Sipwise C5 will accept and further process the request. If the message does not match the rule it will be rejected.

**CAUTION**

An incoming SIP INVITE message must match **all the inbound peering rules** so that Sipwise C5 does not reject the request.

In order to **create an inbound peering rule** you have to select a peering group, press *Details* and then press *Create Inbound Peering Rule* button.

**Peering Servers**

← Back    ★ Create Peering Server

Show 5 entries    Search:

#	Name	IP Address	Hostname	Port	Protocol	Weight	Via Route Set	Enabled
29	test-gw-1	2.3.4.5		5060	1	1		1

Showing 1 to 1 of 1 entries

**Outbound Peering Rules**

ANY of the rules must match to choose the peering group for outbound calls.

★ Create Outbound Peering Rule

Show 5 entries    Search:

#	Callee Prefix	Callee Pattern	Caller Pattern	Description	Enabled
1				Default rule	1

Showing 1 to 1 of 1 entries

**Inbound Peering Rules**

ALL of the rules must match to choose the peering group for inbound calls.

★ Create Inbound Peering Rule

Show 5 entries    Search:

Priority	#	Field	Pattern	Reject Code	Reject Reason	Enabled
No data available in table						

Showing 0 to 0 of 0 entries

Figure 15. Create Inbound Peering Rule

An inbound peering rule has the following **properties**:

Figure 16. Inbound Peering Rule Properties

- Match Field: select which header and which part of that header in a SIP INVITE message will be checked for matching the pattern
- Pattern: a PCRE that defines the accepted value of a header; example: `^sip:.*@example\.org$`—this will match a SIP URI that contains "example.org" in the domain part
- Reject code: optional; a SIP status code that will be sent as a response to an INVITE request that does not match the pattern; example: 403
- Reject reason: optional; an arbitrary text that will be included in the SIP response sent with the *reject code*
- Enabled: a flag to enable / disable the particular inbound peering rule

**NOTE**

Both of the properties Reject code and Reject reason must be left empty if a peering server (i.e. a specific IP address) is part of more peering groups. Such a configuration is useful when an incoming SIP INVITE request needs to be treated differently in the affected peering groups, based on its content, and that's why if the INVITE message only partly matches an inbound peering rule it should not be rejected.

When all settings for a peering group are done the details of the group look like:

**Peering Servers**

← Back    ★ Create Peering Server

Show 5 entries    Search:

#	Name	IP Address	Hostname	Port	Protocol	Weight	Via Route Set	Enabled
29	test-gw-1	2.3.4.5		5060	1	1		1

Showing 1 to 1 of 1 entries

**Outbound Peering Rules**

ANY of the rules must match to choose the peering group for outbound calls.

★ Create Outbound Peering Rule

Show 5 entries    Search:

#	Callee Prefix	Callee Pattern	Caller Pattern	Description	Enabled
1				Default rule	1

Showing 1 to 1 of 1 entries

**Inbound Peering Rules**

ALL of the rules must match to choose the peering group for inbound calls.

★ Create Inbound Peering Rule

Show 5 entries    Search:

Priority	#	Field	Pattern	Reject Code	Reject Reason	Enabled
50	1	to_domain	example\org	403	Invalid called party domain	1

Showing 1 to 1 of 1 entries

Figure 17. Peering Servers Overview

## Routing Order Selection

The selection of peering groups and peering servers for outgoing calls is done in the following way:

- All peering groups that meet the following criteria configured in the outbound peering rule are added to the list of routes for a particular call:
  - Callee's username matches *callee prefix*
  - Callee's URI matches *callee pattern*
  - Caller's URI matches *caller pattern*
- When all matching peering groups are selected, they are ordered by *callee prefix* according to the **longest match basis** (sometimes referred to as the **longest pattern match** or **maximum pattern length match**). One or more peering group with longest *callee prefix* match will be given first positions on the list of routes.
- Peering groups with the same *callee prefix* length are further ordered by **Priority**. Peering group(s) with the higher priorities will occupy higher positions.

### IMPORTANT

Priority **1** gives the *highest* precedence to the corresponding peering group. Hence, a lower priority value will put the peering group higher in the list of routes (compared to other peering groups with the same *callee prefix* length).

Priority can be selected from **1** (highest) to **9** (lowest).

- All peering servers in the peering group with the highest priority (e.g. priority **1**) are tried one-by-one starting from the highest server weight. Peering groups with lower priorities or with shorter *callee prefix* will be used only for fail-over.

The **weight** of the peering servers in the selected peering group will influence the order in which the servers within the group will be tried for routing the outbound call. The weight of a server can be set in the range from **1** to **127**.

### IMPORTANT

Opposite to the peering group priority, a peering server with a higher weight value has a *higher* precedence, but the server weight rather sets a probability than a strict order. E.g. although a peering server with weight **127** has the highest chance to be the first in the list of routes, another server with a lower weight (e.g. **100**) sometimes will be selected first.

In order to find out this probability knowing the weights of peering servers, use the following script:

```
#!/usr/bin/perl

#This script can be used to find out actual probabilities
#that correspond to a list of peering weights.

$num_args = $#ARGV + 1;
if ($num_args < 1) {
    print "Usage: lcr_weight_test.pl <list of weights (integers 1-254)>\n";
    exit 0;
}

my $iters = 10000;
my @rands;

for (my $i=1; $i <= $iters; $i++) {
    my %elem;
    for (my $j=0; $j < $num_args; $j++) {
        my $random = int(rand(2000000000));
        $elem{"$j"} = $ARGV[$j] * $random;
    }
    push(@rands, \%elem);
}

my @counts;
for (my $j=0; $j < $num_args; $j++) {
    $counts["$j"] = 0;
}

foreach my $rand (@rands) {
    my $higher = 0;
    my $higher_key = 0;
    foreach $key (keys %{$rand}) {
        if ($rand->{$key} > $higher) {
```

```

        $higher = $rand->{$key};
        $higher_key = $key;
    }
}
$count[$higher_key]++;
}

for (my $j=0; $j < $num_args; $j++) {
    my $prob = $counts[$j]/$iters;
    print "Peer with weight $ARGV[$j] has probability $prob \n";
}

```

Let us say you have 2 peering servers, one with weight 1 and another with weight 2. At the end—running the script as below—you will have the following traffic distribution:

```

# lcr_weight_test.pl 1 2

Peer with weight 1 has probability 0.2522
Peer with weight 2 has probability 0.7478

```

If a peering server replies with SIP codes 408, 500 or 503, or if a peering server doesn't respond at all, the next peering server in the current peering group is tried as a fallback. All the servers within the group are tried one after another until the call succeeds. If no more servers are left in the current peering group, the next group which matches the outbound peering rules is used.

#### NOTE

The Sipwise C5 may use a slightly different approach in selecting the appropriate peering server if the *peer probing* feature is enabled. See the details in [Peer Probing](#) of the handbook.

## Least Cost Routing (LCR) Configuration

The default call routing uses statically configured peering group priorities to decide where to send the calls. This solution is useful when you have an external SBC that makes all the routing decisions and is described in the [Routing Order Selection](#) section. The Sipwise C5 also allows you routing calls to the cheapest SIP peers saving your termination cost.

To enable LCR routing, do the following:

- Upload the billing fees provided by your peers to the corresponding peering billing profiles
- Enable the LCR module in config.yml (kamailio.proxy.perform\_peer\_lcr: yes)

When the LCR routing is enabled, the selection of peering groups would be the following:

1. All peering groups that meet the following criteria configured in the outbound peering rule are added to the list of routes for a particular call (for pure LCR you might want to omit these filters leaving them blank):

Callee's username matches *callee prefix*

Callee's URI matches *callee pattern*

Caller's URI matches *caller pattern*

2. When all matching peering groups are selected, the longest matching *callee prefix* is selected from each of them. And the peering groups are *temporary* ordered according to the longest matching prefix and priority.
3. Then, the LCR module re-orders the peering groups starting from the lowest termination cost to the highest (ignoring the prefix length and peering group priorities).
4. The platform will first route the call to the servers of the first peering group in this list. If no peering server can terminate the call, the call would fail-over to the second peering group from the list and so on.

**NOTE**

The peering servers in every peering group are sorted and tried according to their weight as described in the previous section.

Let us consider a short example. There are two peering groups (PG1 and PG2) that can deliver calls to New York (e.g. 12121234567) and they have the following rates:

Peering Group	Prefix	Cost	Description
PG1	1	0.02	USA & Canada
PG2	1	0.05	USA & Canada
	1212	0.03	New York, USA

PG1 has only one rate that matches the dialed number, so that it will be taken into account, PG2 has two rates and the longest will be selected. The call will be routed to PG1 servers first as it has a cheaper price and can fail-over to PG2 servers.

The Sipwise C5 LCR feature together with the codec filtering, media transcoding, header manipulations, SIP, and RTP encryption and other SBC features make an external SBC unnecessary. This simplifies your VoIP network and cuts deployment and operation costs.

### 5.6.3. Authenticating and Registering against Peering Servers

#### Proxy-Authentication for outbound calls

If a peering server requires Sipwise C5 to authenticate for outbound calls (by sending a 407 as response to an INVITE), then you have to configure the authentication details in the *Preferences* view of your peer host.

### Peering Servers

← Back   ★ Create Peering Server

Show 5 entries   Search:

#	Name	IP Address	Hostname	Port	Protocol	Weight	Via Route Set	Enabled	
29	test-gw-1	2.3.4.5		5060	1	1		1	<input type="button" value="Edit"/> <input type="button" value="Delete"/> <input type="button" value="Preferences"/>

Showing 1 to 1 of 1 entries

### Outbound Peering Rules

ANY of the rules must match to choose the peering group for outbound calls.

★ Create Outbound Peering Rule

Show 5 entries   Search:

#	Callee Prefix	Callee Pattern	Caller Pattern	Description	Enabled	
1				Default rule	1	

Showing 1 to 1 of 1 entries

### Inbound Peering Rules

ALL of the rules must match to choose the peering group for inbound calls.

★ Create Inbound Peering Rule

Figure 18. Select Peering Server Preferences

To configure this setting, open the *Remote Authentication* tab and edit the following four preferences:

- **peer\_auth\_user:** <username for peer auth>
- **peer\_auth\_pass:** <password for peer auth>
- **peer\_auth\_realm:** <domain for peer auth>
- **peer\_auth\_register:** <enable or disable an outbound registration for the peering>
- **peer\_auth\_hf\_user:** <username parameter for Authorization hf>

#### NOTE

'peer\_auth\_hf\_user' preference is optional and can be skipped. It allows you to set a specific username for the Proxy-Authorization header.

#### IMPORTANT

Before the 10.1 version Sipwise C5 used to only have the `/etc/ngcp-config/templates/etc/sems-b2b/etc/reg_agent.conf.tt2` configuration file to provide outbound registrations for SIP peering(s). Beginning from 10.1 you can choose, whether you want to initiate an outbound registration for your SIP peering using the web administration interface or using the `/etc/ngcp-config/templates/etc/sems-b2b/etc/reg_agent.conf.tt2` configuration file. The recommended way however is to create registrations using the web administration interface. Keep in mind, in case you want to use the web administration interface for that, then you have to remove similar configuration entries from the `/etc/ngcp-config/templates/etc/sems-b2b/etc/reg_agent.conf.tt2`, so that the web administration interface does not duplicate the same registration information (this can lead to several registration sessions created for the same SIP peering host, which is not desired).

Preference peer\_auth\_realm successfully updated

Access Restrictions

Number Manipulations

NAT and Media Flow Control

Remote Authentication

Attribute	Name	Value
peer_auth_user	Peer Authentication User	peeruser1
peer_auth_pass	Peer Authentication Password	peerpass1
peer_auth_realm	Peer Authentication Domain	testpeering.com
peer_auth_register	Enable Peer Authentication	<input type="checkbox"/>
find_subscriber_by_uuid	Find Subscriber by UUID	<input type="checkbox"/>
peer_auth_hf_user	Specific value for the Authorization username	

**IMPORTANT**

If you do NOT authenticate against a peer host, then the caller CLI is put into the From and P-Asserted-Identity headers, e.g. `"4312345" <sip:+4312345@your-domain.com>`. If you DO authenticate, then the +From header is `"4312345" <sip:your_peer_auth_user@your_peer_auth_realm>` (the CLI is in the Display field, the peer\_auth\_user in the From username and the peer\_auth\_realm in the From domain), and the +P-Asserted-Identity header is as usual like `<sip:+4312345@your-domain.com>`. So for presenting the correct CLI in *CLIP no screening* scenarios, your peering provider needs to extract the correct user either from the From Display-Name or from the P-Asserted-Identity URI-User.

**TIP**

If `peer_auth_realm` is set, the system may overwrite the Request-URI with the peer\_auth\_realm value of the peer when sending the call to that peer or peer\_auth\_realm value of the subscriber when sending a call to the subscriber. Since this is rarely a desired behavior, it is disabled by default starting with Sipwise C5 release 3.2. If you need the replacement, you should set `set_ruri_to_peer_auth_realm: 'yes'` in `/etc/ngcp-config/config.yml`.

**Registering at a Peering Server**

A registration process for the SIP peering is quite simple, but since currently this functionality is present both in the web administration interface and in the `/etc/ngcp-config/templates/etc/sems-b2b/etc/reg_agent.conf.tt2` (the last one is an inheritance and will be deprecated in the future), it's worth to dedicate a separate section with an additional description. So that it remains clear for the user of the Sipwise C5 how to properly handle that.

The first and a recommended way to do that - is the web administration interface. It's simple as that, you need to tick a check-box 'peer\_auth\_register', and if previously all needed authentication data has been provided (user, password and realm) the registration process will start right away.

The second way is a manual edition of the dedicated configuration file.

Create a new file `/etc/ngcp-config/templates/etc/sems-b2b/etc/reg_agent.conf.customtt2` as a copy of `/etc/ngcp-config/templates/etc/sems-b2b/etc/reg_agent.conf.tt2`. Configure your peering servers

with the corresponding credentials in the new created file `/etc/ngcp-config/templates/etc/sems-b2b/etc/reg_agent.conf.customtt.tt2`, then execute `ngcpcfg apply "added upstream credentials"`.

**IMPORTANT**

Be aware that this will force SEMS to restart, which will drop running conference calls.

**NOTE**

Sipwise C5 supports outbound registrations via UDP, TCP and TLS. Please see `/etc/ngcp-config/templates/etc/sems-b2b/etc/reg_agent.conf.tt2` to see examples how to enable it using needed transport.

**NOTE**

By default TCP/IP stack implementation in Linux kernel uses so called ephemeral ports for TCP transport, when it comes to originating a brand new TCP session towards remote side. This is usually in the range of 32768 – 60999. This also applies to TLS. However Sipwise C5 can and will always reuse already existing TCP sessions with subscribers, in order to send them out-of-dialog requests (for e.g. INVITE). It works so, because subscribers which register at Sipwise C5, initiate and constantly support a TCP session with Sipwise C5 (either with TCP keepalive mechanisms, or constantly sending new re-registrations or/and OPTIONS).

**TIP**

You can force the Load-Balancer to use a fixed port for sending outbound registrations from your Sipwise C5 platform, by enabling option `'tcp_reuse_port'` (`config.yml kamailio.lb.tcp_reuse_port: yes`). This will force the Load-Balancer to use the same socket descriptor(s), for establishing outbound sessions, as used for listening (this only relates to TCP and TLS). With UDP you can by default initiate sessions from Sipwise C5 using a constant port (usually 5060). Remember enabling `'tcp_reuse_port'` will force all sessions (not only REGISTER) initiated from behalf of Sipwise C5 be established over local port engaged for listening (TCP or TLS).

**TIP**

There is a possibility to define a specific value for the "username" parameter of the Authorization header, in case you want to have another username for the Digest process, than the one used in From/To headers. In order to do that, you have to define the option `'auth_user'` for a desired registration entity. It's being defined separately for each registration entity.

## 5.7. Configuring Rewrite Rule Sets

On the NGCP, every phone number is treated in E.164 format `<country code><area code><subscriber number>`. Rewrite Rule Sets is a flexible tool to translate the caller and callee numbers to the proper format before the routing lookup and after the routing lookup separately. The created Rewrite Rule Sets can be assigned to the domains, subscribers and peers as a preference. Here below you can see how the Rewrite Rules are used by the system:

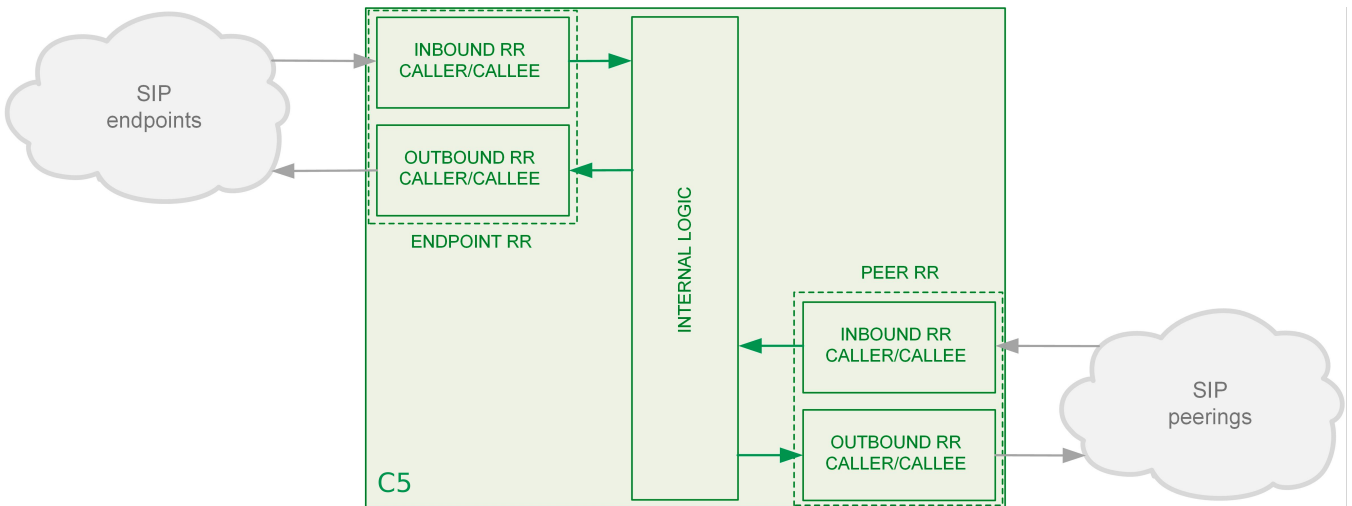

As from the image above, following the arrows, you will have an idea about which type of Rewrite Rules are applied during a call. In general:

- Call from local subscriber A to local subscriber B: Inbound RR from local Domain/Subscriber A and Outbound Rewrite Rules from local Domain/Subscriber B.
- Call from local subscriber A to the peer: Inbound RR from local Domain/Subscriber A and Outbound Rewrite Rules from the peer.
- Call from peer to local subscriber B: Inbound RR from the Peer and Outbound Rewrite Rules from local Domain/Subscriber B.

You would normally begin with creating a Rewrite Rule Set for your SIP domains. This is used to control what an end user can dial for outbound calls, and what is displayed as the calling party on inbound calls. The subscribers within a domain inherit Rewrite Rule Sets of that domain, unless this is overridden by a subscriber Rewrite Rule Set preference.

You can use several special variables in the Rewrite Rules, below you can find a list of them. Some examples of how to use them are also provided in the following sections:

- `${caller_cc}` : This is the value taken from the subscriber's preference CC value under Number Manipulation
- `${caller_ac}` : This is the value taken from the subscriber's preference AC value under Number Manipulation
- `${caller_emergency_cli}` : This is the value taken from the subscriber's preference emergency\_cli value under Number Manipulation
- `${caller_emergency_prefix}` : This is the value taken from the subscriber's preference emergency\_prefix value under Number Manipulation
- `${caller_emergency_suffix}` : This is the value taken from the subscriber's preference emergency\_suffix value under Number Manipulation
- `${caller_cloud_pbx_base_cli}` : This is the value taken from the *Primary Number* field from section *Details Master Data* of the *Pilot Subscriber* for a particular PBX customer.

To create a new Rewrite Rule Set, go to *Settings Rewrite Rule Sets*. There you can create a Set identified by a name. This name is later shown in your peer-, domain- and user-preferences where you can select the rule set you want to use.

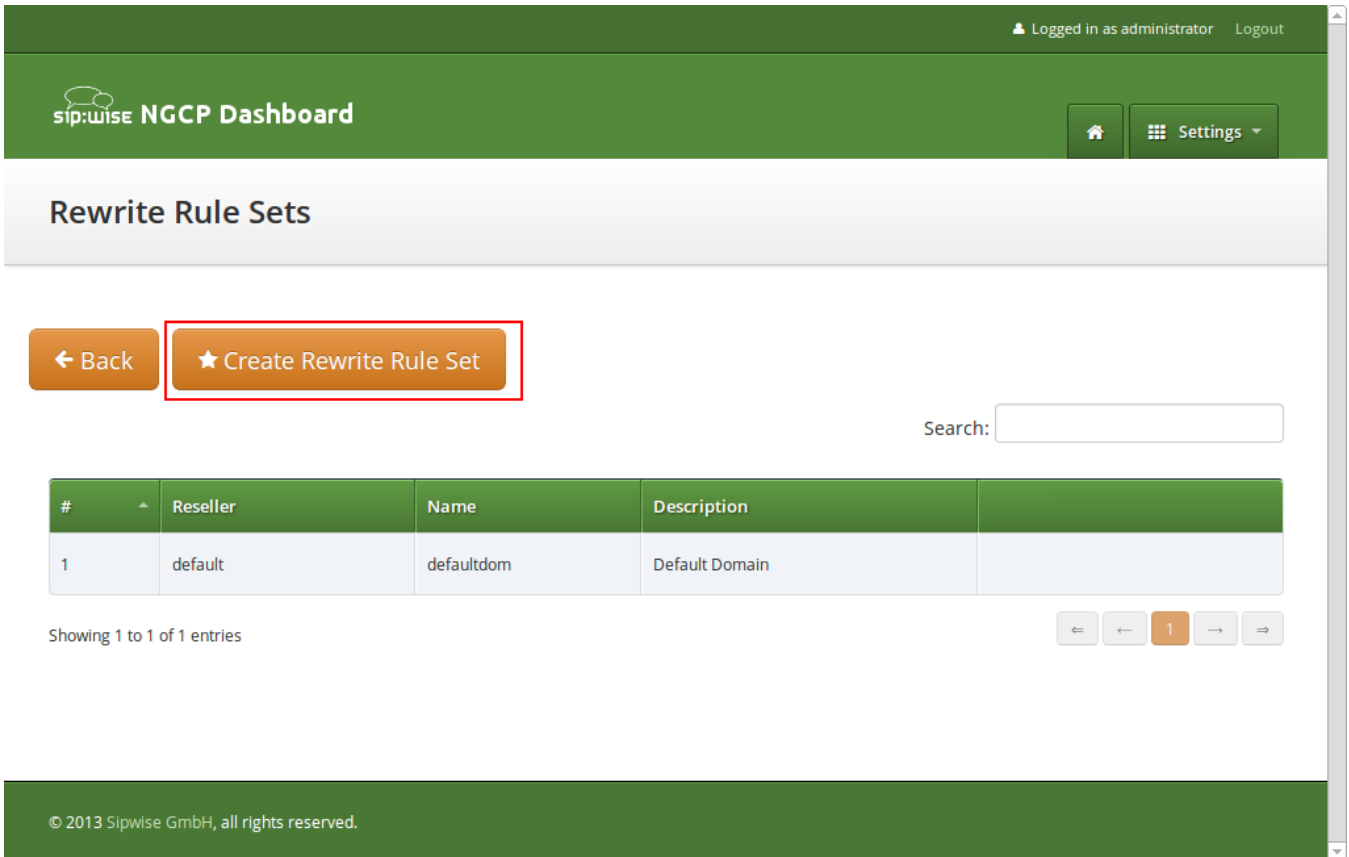

Click *Create Rewrite Rule Set* and fill in the form accordingly.

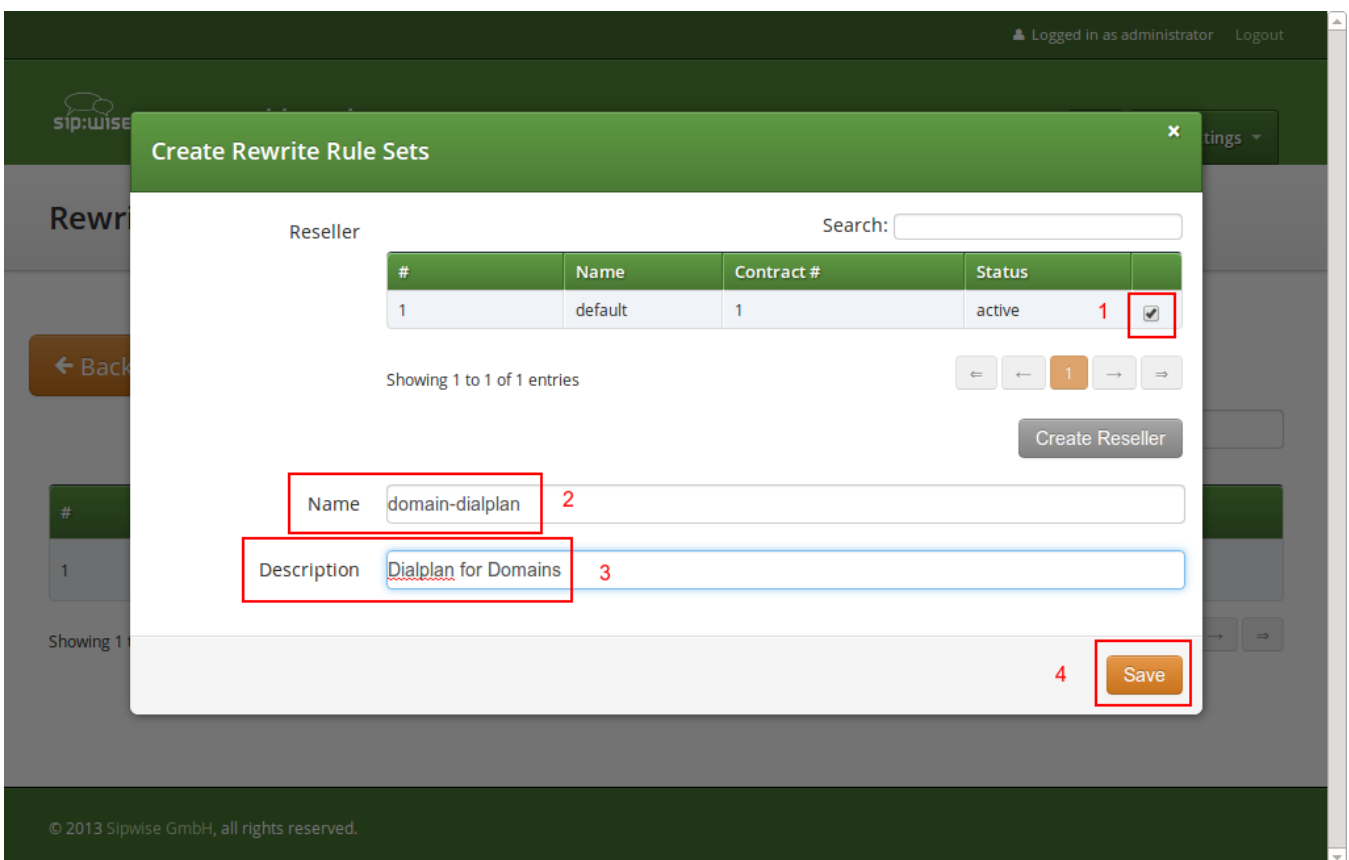

Press the *Save* button to create the set.

To view the *Rewrite Rules* within a set, hover over the row and click the *Rules* button.

Logged in as administrator Logout

**NGCP Dashboard** Settings

## Rewrite Rule Sets

← Back ★ Create Rewrite Rule Set

Rewrite rule set successfully created

Search:

#	Reseller	Name	Description	
1	default	defaultdom	Default Domain	
2	default	domain-dialplan	Dialplan for Domains	<a href="#">Edit</a> <a href="#">Delete</a> <a href="#">Rules</a>

Showing 1 to 2 of 2 entries

The rules are ordered by *Caller* and *Callee* as well as direction *Inbound* and *Outbound*.

### TIP

In Europe, the following formats are widely accepted: `+<cc><ac><sn>`, `00<cc><ac><sn>` and `0<ac><sn>`. Also, some countries allow the areacode-internal calls where only subscriber number is dialed to reach another number in the same area. Within this section, we will use these formats to show how to use rewrite rules to normalize and denormalize number formats.

## 5.7.1. Inbound Rewrite Rules for Caller

These rules are used to normalize user-provided numbers (e.g. passed in *From Display Name* or *P-Preferred-Identity* headers) into E.164 format. In our example, we'll normalize the three different formats mentioned above into E.164 format.

To create the following rules, click on the *Create Rewrite Rule* for each of them and fill them with the values provided below.

*Strip leading 00 or +*

- Match Pattern: `^(00|+)([1-9][0-9]+)$`
- Replacement Pattern: `\2`
- Description: `International to E.164`
- Direction: `Inbound`
- Field: `Caller`

Replace 0 by caller's country code:

- Match Pattern: `^0([1-9][0-9]+)$`
- Replacement Pattern: `${caller_cc}\1`
- Description: **National to E.164**
- Direction: **Inbound**
- Field: **Caller**

Normalize local calls:

- Match Pattern: `^([1-9][0-9]+)$`
- Replacement Pattern: `${caller_cc}${caller_ac}\1`
- Description: **Local to E.164**
- Direction: **Inbound**
- Field: **Caller**

Normalization for national and local calls is possible with special variables `${caller_cc}` and `${caller_ac}` that can be used in Replacement Pattern and are substituted by the country and area code accordingly during the call routing.

### IMPORTANT

These variables are only being filled in when a call originates from a subscriber (because only then the cc/ac information is known by the system), so you can not use them when a calls comes from a SIP peer (the variables will be empty in this case).

**TIP**







When routing a call, the rewrite processing is stopped after the first match of a rule, starting from top to bottom. If you have two rules (e.g. a generic one and a more specific one), where both of them would match some numbers, reorder them with the up/down arrows into the appropriate position.

## Rewrite Rules for domain-dialplan

[← Back](#)
[★ Create Rewrite Rule](#)

Rewrite rule successfully created

### Inbound Rewrite Rules for Caller

	Match Pattern	Replacement Pattern	Description
1  	<code>^(00 \+)([1-9][0-9]+)\$</code>	<code>\2</code>	International to E.164
  2	<code>^0([1-9][0-9]+)\$</code>	<code>\${caller_cc}\1</code>	National to E.164
 	<code>^[1-9][0-9]+\$</code>	<code>\${caller_cc}\${caller_ac}\1</code>	Local to E.164

### Inbound Rewrite Rules for Callee

### Outbound Rewrite Rules for Caller

### Outbound Rewrite Rules for Callee

## 5.7.2. Inbound Rewrite Rules for Callee

These rules are used to rewrite the number the end user dials to place a call to a standard format for routing lookup. In our example, we again allow the three different formats mentioned above and again normalize them to E.164, so we put in the same rules as for the caller.

*Strip leading 00 or +*

- Match Pattern: `^(00|\+)([1-9][0-9]+)$`
- Replacement Pattern: `\2`
- Description: **International to E.164**
- Direction: **Inbound**
- Field: **Callee**

*Replace 0 by caller's country code:*

- Match Pattern: `^0([1-9][0-9]+)$`
- Replacement Pattern: `${caller_cc}\1`
- Description: **National to E.164**

- Direction: **Inbound**
- Field: **Callee**

*Normalize areacode-internal calls:*

- Match Pattern: `^([1-9][0-9]+)$`
- Replacement Pattern: `/${caller_cc}/${caller_ac}\1`
- Description: **Local to E.164**
- Direction: **Inbound**
- Field: **Callee**

#### TIP

Our provided rules will only match if the caller dials a numeric number. If he dials an alphanumeric SIP URI, none of our rules will match and no rewriting will be done. You can however define rules for that as well. For example, you could allow your end users to dial support and rewrite that to your support hotline using the match pattern `^support$` and the replace pattern `43800999000` or whatever your support hotline number is.

### 5.7.3. Outbound Rewrite Rules for Caller

These rules are used to rewrite the calling party number for a call to an end user. For example, if you want the device of your end user to show `0<ac><sn>` if a national number calls this user, and `00<cc><ac><sn>` if an international number calls, put the following rules there.

*Replace Austrian country code 43 by 0*

- Match Pattern: `^43([1-9][0-9]+)$`
- Replacement Pattern: `0\1`
- Description: **E.164 to Austria National**
- Direction: **Outbound**
- Field: **Caller**

*Prefix 00 for international caller*

- Match Pattern: `^([1-9][0-9]+)$`
- Replacement Pattern: `00\1`
- Description: **E.164 to International**
- Direction: **Outbound**
- Field: **Caller**

#### TIP

Note that both of the rules would match a number starting with **43**, so reorder the national rule to be above the international one (if it's not already the case).

### 5.7.4. Outbound Rewrite Rules for Callee

These rules are used to rewrite the called party number immediately before sending out the call on the network. This gives you an extra flexibility by controlling the way request appears on a wire, when your

SBC or other device expects the called party number to have a particular tech-prefix. It can be used on calls to end users too if you want to do some processing in intermediate SIP device, e.g. apply legal intercept selectively to some subscribers.

*Prefix sipsp# for all calls*

- Match Pattern: `^([0-9]+)$`
- Replacement Pattern: `sipsp#\1`
- Description: `Intercept this call`
- Direction: `Outbound`
- Field: `Callee`

### 5.7.5. Emergency Number Handling

There are 2 ways to handle calls from local subscribers to emergency numbers in NGCP:

- *Simple* emergency number handling: inbound rewrite rules append an emergency tag to the called number, this will be recognised by NGCP's call routing logic and the call is routed directly to a peer. Please read the next section for details of simple emergency number handling.
- An emergency *number mapping* is applied: a dedicated emergency number mapping database is consulted in order to obtain the most appropriate routing number of emergency services. This logic ensures that the caller will contact the geographically closest emergency service. Please visit the [Emergency Mapping](#) section of the handbook for more details.

#### NOTE

If Sipwise C5 detects that the call is of an emergency type, then by default it will not apply concurrent calls limitation defined by your license. In order to change this behavior globally, you can set the `config.yml` option `'b2b.sbc.skip_cpslimit_license_check_emergency'` to `'no'` (which is by default set to `'yes'`). Remember, by applying the changes the SEMS-B2B component will have to restart.

### Simple Emergency Number Handling Overview

The overview of emergency call processing is as follows:

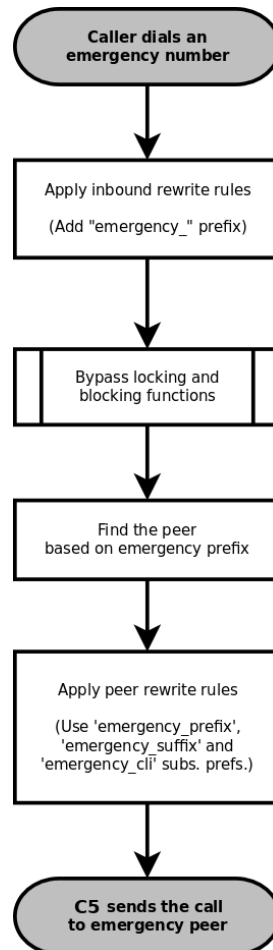

Figure 19. Simple Emergency Call Handling

Configuring Emergency Numbers is also done via Rewrite Rules.

### Tagging Inbound Emergency Calls

For Emergency Calls from a subscriber to the platform, you need to define an *Inbound Rewrite Rule For Callee*, which adds a prefix **emergency\_** to the number (and can rewrite the number completely as well at the same time). If the proxy detects a call to a SIP URI starting with **emergency\_**, it will enter a special routing logic bypassing various checks which might make a normal call fail (e.g. due to locked or blocked numbers, insufficient credits or exceeding the max. amount of parallel calls).

#### Tag an Emergency Call

- Match Pattern: **^(911|112)\$**
- Replacement Pattern: **emergency\_\1**
- Description: **Tag Emergency Numbers**
- Direction: **Inbound**
- Field: **Callee**

To route an Emergency Call to a Peer, you can select a specific peering group by adding a peering rule with a *callee prefix* set to **emergency\_** to a peering group.

## Normalize Emergency Calls for Peers

In order to normalize the emergency number to a valid format accepted by the peer, you need to assign an *Outbound Rewrite Rule For Callee*, which strips off the `emergency_` prefix. You can also use the variables `${caller_emergency_cli}`, `${caller_emergency_prefix}` and `${caller_emergency_suffix}` as well as `${caller_ac}` and `${caller_cc}`, which are all configurable per subscriber to rewrite the number into a valid format.

### *Normalize Emergency Call for Peer*

- Match Pattern: `^emergency_(.+)$`
- Replacement Pattern: `${caller_emergency_prefix}${caller_ac}\1`
- Description: `Normalize Emergency Numbers`
- Direction: `Outbound`
- Field: `Callee`

## 5.7.6. Emergency Geo-location Formats

A tagged Emergency Call from a subscriber will have Geo-location information attached to the SDP when `emergency_location_object` preference is properly set depending on the format defined at subscriber's `emergency_location_format` preference.

These are the `emergency_location_format` formats that Sipwise C5 currently supports:

- `PIDF-LO` (TR Notruf v2)
- `cirpack` (TR Notruf v1)

### PIDF-LO format

`emergency_provider_info` preference must be defined at domain level with `application/xml` as content-type and the whole XML with the provider info described. For instance:

```
<?xml version="1.0" encoding="UTF-8"?>
<emergencyCall.ProviderInfo
xmlns="urn:iETF:params:xml:ns:emergencyCall.ProviderInfo">
  <DataProviderString>Telekom</DataProviderString>
  <ProviderID>D150</ProviderID>
  <contactURI>sip:+492911234567@telekom.de;user=phone</contactURI>
  <ProviderIDSeries>BNetzA</ProviderIDSeries>
</emergencyCall.ProviderInfo>
```

`emergency_location_object` preference can be defined at subscriber level with `application/pidf+xml` as content-type and the whole XML containing the Geo-location as PIDF-LO.

It can use different location encodings but there are two mandatory elements that need a special value in order to be replaced by Sipwise C5 at the moment of initiating the emergency call:

- `timestamp`

- `retention-expiry`

```
<retention-expiry>$$expiry$$</retention-expiry>
<timestamp>$$ts$$</timestamp>
```

An example of XML document with the mandatory elements:

```
<?xml version="1.0" encoding="UTF-8"?>
<presence
  xmlns="urn:ietf:params:xml:ns:pidf"
  xmlns:gp="urn:ietf:params:xml:ns:pidf:geopriv10"
  xmlns:gml="http://www.opengis.net/gml"
  xmlns:gs="http://www.opengis.net/pidflo/1.0"
  xmlns:cl="urn:ietf:params:xml:ns:pidf:geopriv10:civicAddr"
  entity="pres:123@t-mobile.de">
  <tuple id="arcband">
    <status>
      <gp:geopriv>
        <gp:location-info>
          <gml:location>
            <gs:ArcBand srsName="urn:ogc:def:crs:EPSG:: 4258"
              xmlns:gs="http://www.opengis.net/pidflo/1.0"
              xmlns:gml="http://www.opengis.net/gml">
              <gml:pos>49.8967 8.6228</gml:pos>
              <gs:innerRadius
uom="urn:ogc:def:uom:EPSG::9001">0</gs:innerRadius>
              <gs:outerRadius
uom="urn:ogc:def:uom:EPSG::9001">2005</gs:outerRadius>
              <gs:startAngle
uom="urn:ogc:def:uom:EPSG::9102">328</gs:startAngle>
              <gs:openingAngle
uom="urn:ogc:def:uom:EPSG::9102">64</gs:openingAngle>
            </gs:ArcBand>
          </gml:location>
          <con:confidence>100</con:confidence>
          <cl:civicAddress xml:lang="de">
            <cl:LOC>Mobilfunkzelle</cl:LOC>
            <cl:ADDCODE>26201F1080939A</cl:ADDCODE>
          </cl:civicAddress>
        </gp:location-info>
        <gp:usage-rules>
          <gbp:retransmission-allowed>yes</gbp:retransmission-allowed>
          <gbp:retention-expiry>$$expiry$$</gbp:retention-expiry>
        </gp:usage-rules>
      </gp:geopriv>
    </status>
    <timestamp>$$ts$$</timestamp>
  </tuple>
</presence>
```

## cirpack format

`emergency_location_object` preference can be defined at subscriber level with `application/vnd.cirpack.isdn-ext` as content-type and the hex string. For instance: `7e 0d 04 55 75 69 20 4d 61 6b 65 43 61 6c 6c`

### 5.7.7. Assigning Rewrite Rule Sets to Domains and Subscribers

Once you have finished to define your Rewrite Rule Sets, you need to assign them. For sets to be used for subscribers, you can assign them to their corresponding domain, which then acts as default set for all subscribers. To do so, go to *SettingsDomains* and click *Preferences* on the domain you want the set to assign to. Click on *Edit* and select the Rewrite Rule Set created before.

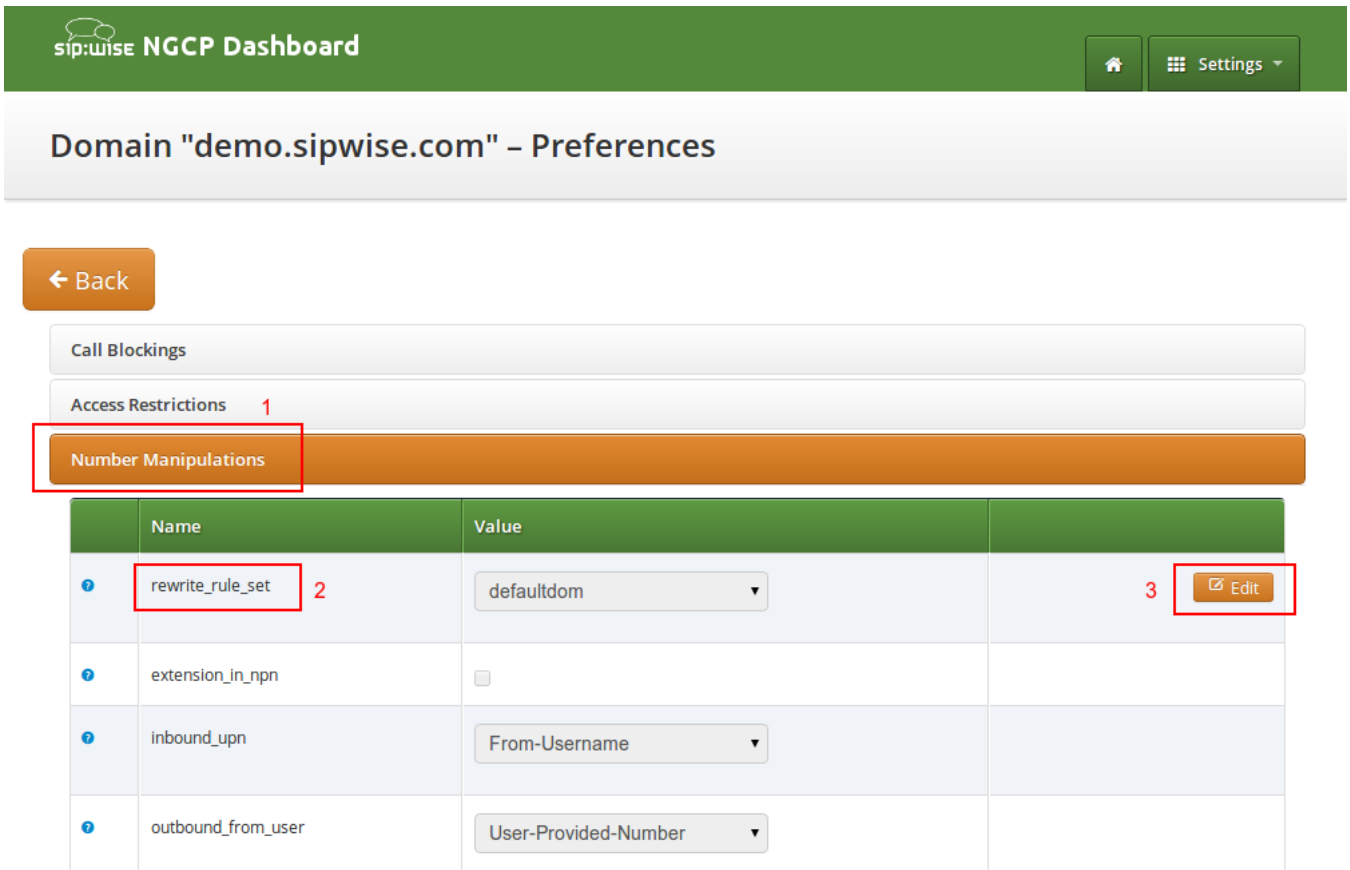

The screenshot shows the Sipwise NGCP Dashboard interface. At the top, there's a green header with the logo and 'NGCP Dashboard'. Below it, a white header displays 'Domain "demo.sipwise.com" - Preferences'. A navigation bar contains a 'Back' button. The main content area is divided into sections: 'Call Blockings', 'Access Restrictions 1', and 'Number Manipulations' (highlighted in orange). Below 'Number Manipulations' is a table with the following data:

Name	Value	
rewrite_rule_set 2	defaultdom	3 Edit
extension_in_npn	<input type="checkbox"/>	
inbound_upn	From-Username	
outbound_from_user	User-Provided-Number	

You can do the same in the *Preferences* of your subscribers to override the rule on a subscriber basis. That way, you can finely control down to an individual user the dial-plan to be used. Go to *SettingsSubscribers*, click the *Details* button on the subscriber you want to edit, then click the *Preferences* button.

### 5.7.8. Creating Dialplans for Peering Servers

For each peering server, you can use one of the Rewrite Rule Sets that was created previously as explained in [Configuring Rewrite Rule Sets](#) (keep in mind that special variables `${caller_ac}` and `${caller_cc}` can not be used when the call comes from a peer). To do so, click on the name of the peering server, look for the preference called *Rewrite Rule Sets*.

If your peering servers don't send numbers in E.164 format `<cc><ac><sn>`, you need to create *Inbound Rewrite Rules* for each peering server to normalize the numbers for caller and callee to this format, e.g. by stripping leading `+` or put them from national into E.164 format.

Likewise, if your peering servers don't accept this format, you need to create *Outbound Rewrite Rules* for each of them, for example to append a '+' to the numbers.

### 5.7.9. Call Routing Verification

The Sipwise C5 provides a utility that helps with the verification of call routing among local subscribers and peers. It is called *Call Routing Verification* and employs rewrite rules and peer selection rules, in order to process calling and called numbers or SIP users and find the appropriate peer for the destination.

The *Call Routing Verification* utility performs only basic number processing and does not invoke the full number manipulation logic applied on real calls. The goal is to enable testing of rewrite rules, rather than validate the complete number processing.

- What is considered during the test:
  - subscriber preferences: cli and allowed\_clis
  - domain / subscriber / peer rewrite rules
- What is not taken into account during the test:
  - other subscriber or peer preferences
  - LNP (Local Number Portability) lookup on called numbers; LNP rewrite rules

You can access the utility following the path on Admin web interface: *Tools Call Routing Verification*.

#### **Expected input data**

- Caller number/uri: 2 formats are accepted in this field:
  - A simple **phone number** in international (00431... +431...) or E.164 (431...) format.
  - A SIP **URI** in **username@domain** format (without adding "sip:" at the beginning).
- Callee number/uri: The same applies as for Caller number/uri.
- Caller Type: Select **Subscriber** or **Peer**, depending on the source of the call.
- Caller Subscriber or Caller Peer: Optionally, you can select the subscriber or peer explicitly. Without the explicit selection, however, the *Call Routing Verification* tool is able to find the caller in the database, based on the provided number / URI.
- Caller RWR Override, Callee RWR Override, Callee Peer Override: The caller / callee rewrite rules and peer selection rules defined in domain, subscriber and peer preferences are used for call processing by default. But you can also override them by explicitly selecting another rewrite or peer selection rule.

#### **Examples**

1. Using only phone numbers and explicit subscriber selection

Input Data:

### Call Routing Verification

[← Back](#) [Expand Groups](#)

Caller number/url:

Callee number/url:

Caller Type:  Subscriber  Peer

Caller Subscriber Search:

#	Username	Domain	UUID	Number	
295	43993002	10.15.18.227	51e32173-c8a9-44f1-af30-a1ed431eb2bf		<input checked="" type="checkbox"/>
297	43993003	10.15.18.227	6feb9ea-21c0-4f55-8828-80d546b8998f		<input type="checkbox"/>
299	43993004	10.15.18.227	3543a26e-861b-459f-a348-a8ef3e1e9eab		<input type="checkbox"/>
301	43993005	10.15.18.227	355773d2-1c08-475c-8858-eaf75bb58c73		<input type="checkbox"/>

Showing 1 to 4 of 8 entries (filtered from 56 total entries) ← 1 2 →

Caller Rewrite Rules Override

Callee Rewrite Rules Override

Callee Peer Override

[Verify](#)

Figure 20. Call Routing Verif. - Only Numbers - Input

Result:

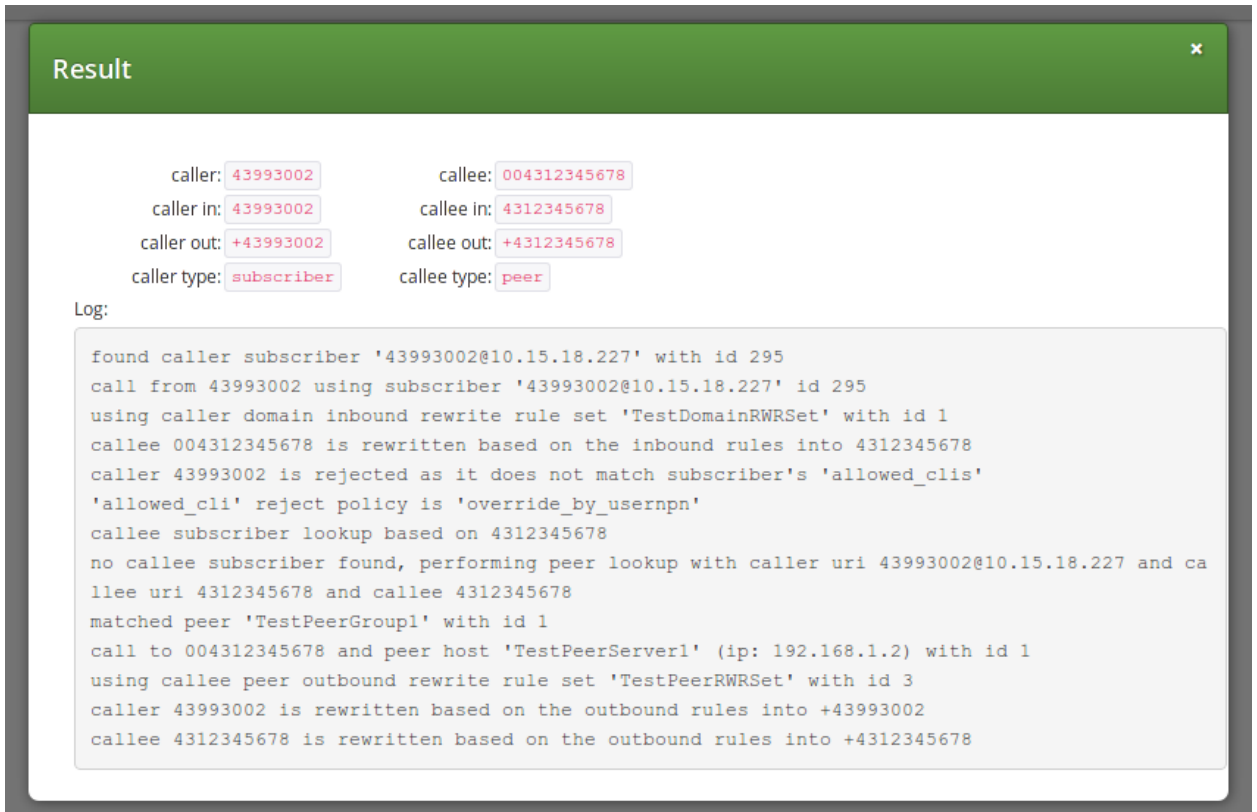

The screenshot shows a 'Result' window with a green header and a white body. The body contains call routing details and a log. The details are as follows:

caller:	43993002	callee:	004312345678
caller in:	43993002	callee in:	4312345678
caller out:	+43993002	callee out:	+4312345678
caller type:	subscriber	callee type:	peer

Log:

```
found caller subscriber '43993002@10.15.18.227' with id 295
call from 43993002 using subscriber '43993002@10.15.18.227' id 295
using caller domain inbound rewrite rule set 'TestDomainRWRSet' with id 1
callee 004312345678 is rewritten based on the inbound rules into 4312345678
caller 43993002 is rejected as it does not match subscriber's 'allowed_cli'
'allowed_cli' reject policy is 'override_by_usernpn'
callee subscriber lookup based on 4312345678
no callee subscriber found, performing peer lookup with caller uri 43993002@10.15.18.227 and ca
llee uri 4312345678 and callee 4312345678
matched peer 'TestPeerGroup1' with id 1
call to 004312345678 and peer host 'TestPeerServer1' (ip: 192.168.1.2) with id 1
using callee peer outbound rewrite rule set 'TestPeerRWRSet' with id 3
caller 43993002 is rewritten based on the outbound rules into +43993002
callee 4312345678 is rewritten based on the outbound rules into +4312345678
```

Figure 21. Call Routing Verif. - Only Numbers - Result

2. Using phone number and URI, without explicit subscriber selection

Input Data:

### Call Routing Verification

[← Back](#) [Expand Groups](#)

Caller number/url:

Callee number/url:

Caller Type:  Subscriber  Peer

Caller Subscriber Search:

#	Username	Domain	UUID	Number	
295	43993002	10.15.18.227	51e32173-c8a9-44f1-af30-a1ed431eb2bf		<input type="checkbox"/>
297	43993003	10.15.18.227	6feb9ea-21c0-4f55-8828-80d546b8998f		<input checked="" type="checkbox"/>
299	43993004	10.15.18.227	3543a26e-861b-459f-a348-a8ef3e1e9eab		<input type="checkbox"/>
301	43993005	10.15.18.227	355773d2-1c08-475c-8858-eaf75bb58c73		<input type="checkbox"/>

Showing 1 to 4 of 8 entries (filtered from 56 total entries) ← 1 2 →

Caller Rewrite Rules Override

Callee Rewrite Rules Override

Callee Peer Override

[Verify](#)

Figure 22. Call Routing Verif. - Number and URI - Input

Result:

### Result

caller:	43993003	callee:	+431555666
caller in:	43993003	callee in:	431555666
caller out:	+43993003	callee out:	+431555666
caller type:	subscriber	callee type:	peer

Log:

```
no caller subscriber/peer was specified, using subscriber lookup based on caller 43993003@10.15.18.227
found caller subscriber '43993003@10.15.18.227' with id 297
call from 43993003 using subscriber '43993003@10.15.18.227' id 297
using caller domain inbound rewrite rule set 'TestDomainRWRSet' with id 1
callee +431555666 is rewritten based on the inbound rules into 431555666
caller 43993003 is rejected as it does not match subscriber's 'allowed_clis'
'allowed_cli' reject policy is 'override_by_usernpn'
callee subscriber lookup based on 431555666
no callee subscriber found, performing peer lookup with caller uri 43993003@10.15.18.227 and callee uri 431555666 and callee 431555666
matched peer 'TestPeerGroup1' with id 1
call to +431555666 and peer host 'TestPeerServer1' (ip: 192.168.1.2) with id 1
using callee peer outbound rewrite rule set 'TestPeerRWRSet' with id 3
caller 43993003 is rewritten based on the outbound rules into +43993003
callee 431555666 is rewritten based on the outbound rules into +431555666
```

Figure 23. Call Routing Verif. - Number and URI - Result

# Chapter 6. Billing

This chapter describes the steps necessary to rate calls and export rated CDRs (call detail records) to external systems.

## 6.1. Billing Profiles

Service billing on Sipwise C5 is based on billing profiles, which may be assigned to customers and SIP peerings. The design focuses on a simple, yet flexible approach, to support arbitrary dial-plans without introducing administrative overhead for the system administrators. The billing profiles may define a base fee and free time or free money per billing interval. Unused free time or money automatically expires at the end of the billing interval.

Each profile may have call destinations (usually based on E.164 number prefix matching) with configurable fees attached. Call destination fees each support individual intervals and rates, with a different duration and/or rate for the first interval. (e.g.: charge the first minute when the call is opened, then every 30 seconds, or make it independent of the duration at all) It is also possible to specify different durations and/or rates for peak and off-peak hours. Peak time may be specified based on weekdays, with additional support for manually managed dates based on calendar days. The call destinations can finally be grouped for an overview on user's invoices by specifying a zone in two detail levels. (E.g.: national landline, national mobile, foreign 1, foreign 2, etc.)

### 6.1.1. Creating Billing Profiles

The first step when setting up billing data is to create a billing profile, which will be the container for all other billing related data. Go to *SettingsBilling* and click on *Create Billing Profile*.

The screenshot shows the 'Create Billing Profiles' dialog box. At the top, it says 'Logged in as administrator' and 'Logout'. The dialog has a green header with 'Create Billing Profiles' and a close button. Below the header, there is a 'Reseller' section with a search bar. A table lists resellers with columns: #, Name, Contract #, Status, and a checkbox. The first row is selected, with a red box around the checkbox. Below the table, it says 'Showing 1 to 1 of 1 entries' and has navigation buttons. A 'Create Reseller' button is also present. Below the table, there are input fields: 'Handle' (mytestprofile) with a red box and a '2', 'Name' (My Test Profile) with a red box and a '3', and 'Interval charge' (0). There is also a 'Prepaid' checkbox. At the bottom right, there is a 'Save' button with a red box and a '4'. The background shows a blurred view of the 'Billing' settings page.

#	Name	Contract #	Status	
1	default	1	active	1 <input checked="" type="checkbox"/>

The fields *Reseller*, *Handle* and *Name* are mandatory.

- **Reseller:** The reseller this billing profile belongs to.
- **Handle:** A unique, permanently fixed string which is used to attach the billing profile to a customer or SIP peering contract.
- **Name:** A free form string used to identify the billing profile in the *Admin Panel*. This may be changed at any time.
- **Ignore domain:** If enabled, the rating engine will skip matching billing fees as `destination_user_in@destination_domain` and use `destination_user_in` instead.
- **Prepaid:** Enables prepaid accounting for this profile as opposed to normal post-paid mode.
- **Prepaid library:** one of available prepaid libraries to use for the prepaid accounting
- **Advice of charge:** Enables Advice of Charge support to send call costs in the SIP INFO messages back to the caller. The *Billing Fees* are used in the cost and interval calculations.
- **Interval charge:** A base fee for the billing interval, specifying a monetary amount (represented as a floating point number) in whatever currency you want to use.
- **Interval free time:** If you want to include free calling time in your billing profile, you may specify the number of seconds that are available every billing interval. See *Creating Billing Fees* below on how to select destinations which may be called using the free time.
- **Interval free cash:** Same as for *interval free time* above, but specifies a monetary amount which may be spent on outgoing calls. This may be used for example to implement a minimum turnover for a contract, by setting the *interval charge* and *interval free cash* to the same values.
- **Fraud monthly limit:** The monthly fraud detection limit (in Cent) for accounts with this billing profile. If the call fees of an account reach this limit within a billing interval, an action can be triggered.
- **Fraud monthly lock:** a choice of *none*, *foreign*, *outgoing*, *incoming*, *global*. Specifies a lock level which will be used to lock the account and his subscribers when *fraud monthly limit* is exceeded.
- **Fraud monthly notify:** An email address or comma-separated list of email addresses that will receive notifications when *fraud monthly limit* is exceeded.
- **Fraud daily limit:** The fraud detection limit (in Cent) for accounts with this billing profile. If the call fees of an account reach this limit within a calendar day, an action can be triggered.
- **Fraud daily lock:** a choice of *none*, *foreign*, *outgoing*, *incoming*, *global*. Specifies a lock level which will be used to lock the account and his subscribers when *fraud daily limit* is exceeded.
- **Fraud daily notify:** An email address or comma-separated list of email addresses that will receive notifications when *fraud daily limit* is exceeded.
- **Currency:** The currency symbol for your currency. Any UTF-8 character may be used and will be printed in web interfaces.
- **VAT rate:** The percentage of value added tax for all fees in the billing profile. Currently for informational purpose only and not used further.
- **VAT included:** Whether VAT is included in the fees entered in web forms or uploaded to the platform. Currently for informational purpose only and not used further.

### 6.1.2. Creating Billing Fees

Each *Billing Profile* holds multiple *Billing Fees*.

To set up billing fees, click on the *Fees* button of the billing profile you want to configure. Billing fees may be uploaded using a configurable CSV file format, or entered directly via the web interface by clicking *Create Fee Entry*. To configure the CSV field order for the file upload, rearrange the entries in the `www_adminfees_csvelement_order` array in `/etc/ngcp-config/config.yml` and execute the command `ngcpcfg apply 'changed fees element order'`. The following is an example of working CSV file to upload (pay attention to double quotes):

```

"." ,"^1",out,"EU","ZONE
EU",5.37,60,5.37,60,5.37,60,5.37,60,0,0,regex_longest_pattern
"^01.+$$","^02145.+$$",out,"AT","ZONE
Test",0.06250,1,0.06250,1,0.01755,1,0.01733,1,0,regex_longest_pattern,30
,0.01,30,0.01

```

For input via the web interface, fill in the text fields accordingly.

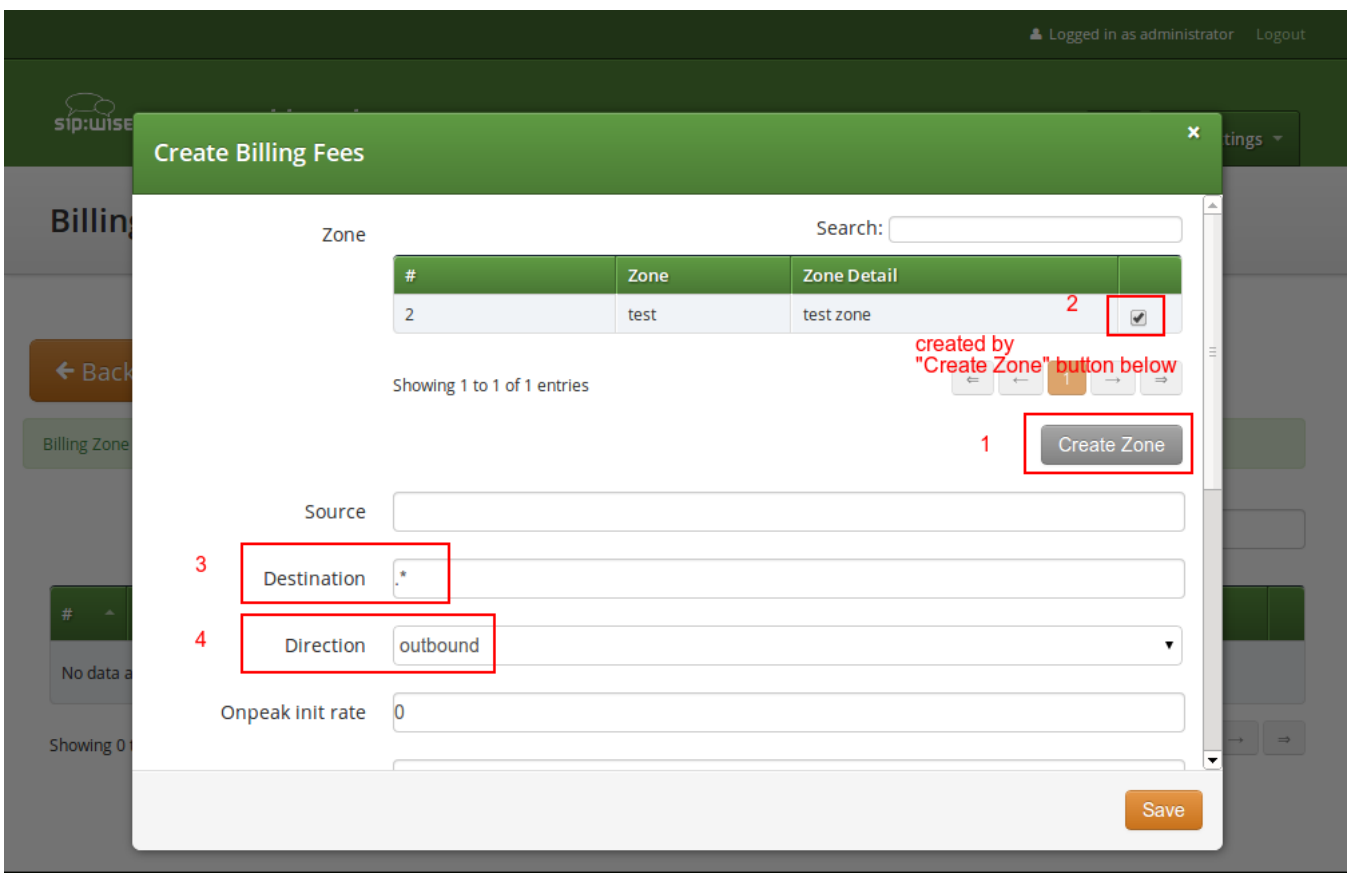

A billing fee record essentially defines the rate per interval to charge the customer when calling a particular destination number. The properties below outline supported options in detail:

- **Zone:** A zone for a group of fees. May be used to group fees for simplified display, e.g. on invoices. (e.g. foreign zone 1)
- **Match Mode:** The mode for matching a fee's source and destination patterns against a CDR's source fields (the caller given by `<source_cli>@<source_domain>` or `<source_cli>` only) and destination fields (the callee given by `<destination_user_in>@<destination_domain>` or `<destination_user_in>` only). Each of the currently supported modes below provide different flexibility and speed:

1. Exact string (destination): The destination string has to match the destination from the CDR exactly. Fastest,  $O(\log(\#fees))$ . In csv files, this match mode is specified by `exact_destination`.
2. Prefix string: The fee's source/destination represent strings which both the source/destination from the CDR have to start with. The fee with the longest destination prefix is picked. If there are multiple, the one with the longest source prefix is picked. In contrast to regular-expression based match modes, this algorithm uses database index lookups instead of SQL `REGEXP` table scans. The performance boundary is  $O(\text{length}(\text{cdr src}) * \text{length}(\text{cdr dest}) * \log(\#fees))$ , hence this will be the preferred mode for tens of thousands of fees in place or high throughput (LCR, rating peer-to-peer calls). In csv files, this match mode is specified by `prefix`.
3. Regular expression - longest match: The fee's source/destination patterns represent PCREs which both have to match the source/destination from the CDR. The fee with the longest match within the destination string is picked. If there are multiple, the one with the longest match within the source string is picked. In csv files, this match mode is specified by `regex_longest_match`.
4. Regular expression - longest pattern: The fee's source/destination represent PCREs which both have to match the source/destination from the CDR. The fee with the longest (most distinctive) destination pattern is picked. If there are multiple, the one with the longest (most distinctive) source pattern is picked. In csv files, this match mode is specified by `regex_longest_pattern`.

If fees with different match mode are in place and matching, the precedence is given by above order. When omitted in file uploads, the legacy default `regex_longest_pattern` is used.

- **Source:** The source pattern (prefix ie. `123` or regular expression `^123someone@sip\.sipwise\.com$`). The legacy default `."` regular expression (matching everything) will be set implicitly.
- **Destination:** The destination pattern (string ie. `456somebody@sip.sipwise.com`, prefix ie. `456` or regular expression `^456somebody@sip\.sipwise\.com$`). This field must be set.

To specify a special fixed rate for any ported number in the local LNP tables belonging to an LNP provider, a fee with `exact_destination` match mode and destination `lnp:<lnp provider ID>` can be set up.

To specify an FCI (Furnished Charging Info) destination for cases when the FCI data is retrieved from the LNP lookup, use a format `fci=10050` where "10050" is the FCI data.

- **Direction:** Outbound for standard origination fees (applies to callers placing a call and getting billed for that) or Inbound for termination fees (applies to callees if you want to charge them for receiving various calls, e.g. for 800-numbers). *If in doubt, use Outbound.* If you upload fees via CSV files, use `out` or `in`, respectively.

#### IMPORTANT

The {match mode, source, destination, direction} combination needs to be unique for a billing profile. The system will return an error if such a set is specified twice via web interface/ or /api, or skipped when processing the file upload. When uploading fees, the *Purge Existing* checkbox allows to drop all existing fees before creating the records.

#### IMPORTANT

There are several internal services (vsc, conference, voicebox, fax2mail) which will need a specific destination entry with a domain-based destination. If you don't want to charge the same (or nothing) for those services, add a fee for destination `\.local$` there. If you want to charge different amounts for those services, break it down into separate fee entries for `@fax2mail\.local$`, `@vsc\.local$`, `@conference\.local$` and `@voicebox\.local$` with the

according fees. **NOT CREATING EITHER THE CATCH-ALL FEE OR THE SEPARATE FEES FOR THE `.local` DOMAIN WILL BREAK YOUR RATING PROCESS!**

- **Onpeak init rate:** The rate for the first rating interval in cent (of whatever currency, represented as a floating point number) per second. Applicable to calls during onpeak hours.
- **Onpeak init interval:** The duration of the first billing interval, in seconds. Applicable to calls during onpeak hours.
- **Onpeak follow rate:** The rate for subsequent rating intervals in cent (of whatever currency, represented as a floating point number) per second. Applicable to calls during onpeak hours. Defaults to *onpeak init rate*.
- **Onpeak follow interval:** The duration of subsequent billing intervals, in seconds. Applicable to calls during onpeak hours. Defaults to *onpeak init interval*.
- **Offpeak init rate:** The rate for the first rating interval in cent (of whatever currency, represented as a floating point number) per second. Applicable to calls during off-peak hours. Defaults to *onpeak init rate*.
- **Offpeak init interval:** The duration of the first billing interval, in seconds. Applicable to calls during off-peak hours. Defaults to *onpeak init interval*.
- **Offpeak follow rate:** The rate for subsequent rating intervals in cent (of whatever currency, represented as a floating point number) per second. Applicable to calls during off-peak hours. Defaults to *offpeak init rate* if that one is specified, or to *onpeak follow rate* otherwise.
- **Offpeak follow interval:** The duration of subsequent billing intervals, in seconds. Applicable to calls during off-peak hours. Defaults to *offpeak init interval* if that one is specified, or to *onpeak follow interval* otherwise.
- **Onpeak use free time:** Specifies whether free time minutes may be used when calling this destination during onpeak hours. Specified in the file upload as 0, [no], [false] and 1, [yes], [true] respectively.
- **Offpeak use free time:** Specifies whether free time minutes may be used when calling this destination during off-peak. Specified in the file upload as 0, [no], [false] and 1, [yes], [true] respectively.
- **Onpeak extra second:** If defined, an extra rate will be charged at the given second of call time for post-paid calls. Applicable to calls started during onpeak hours.
- **Onpeak extra rate:** The rate to charge if the call time exceeds *extra second* in cent (of whatever currency, represented as a floating point number). Applicable to calls started during onpeak hours.
- **Offpeak extra second:** See onpeak extra second. Applicable to calls started during offpeak hours.
- **Offpeak extra rate:** See onpeak extra rate. Applicable to calls started during offpeak hours.

### 6.1.3. Creating Off-Peak Times

To be able to differentiate between on-peak and off-peak calls, the platform stores off-peak times for every billing profile based on weekdays and/or calendar days. To edit the settings for a billing profile, go to *SettingsBilling* and press the *Off-Peaktimes* button on the billing profile you want to configure.

To set off-peak times for a weekday, click on *Edit* next to the according weekday. You will be presented with two input fields which both receive a timestamp in the form of *hh:mm:ss* specifying a time of day for the start and end of the off-peak period. If any of the fields is left empty, the system will

automatically insert 00:00:00 (*start* field) or 23:59:59 (*end* field). Click on *Add* to store the setting in the database. You may create more than one off-peak period per weekday. To delete a range, click *Delete* next to the entry. Click the *close* icon when done.

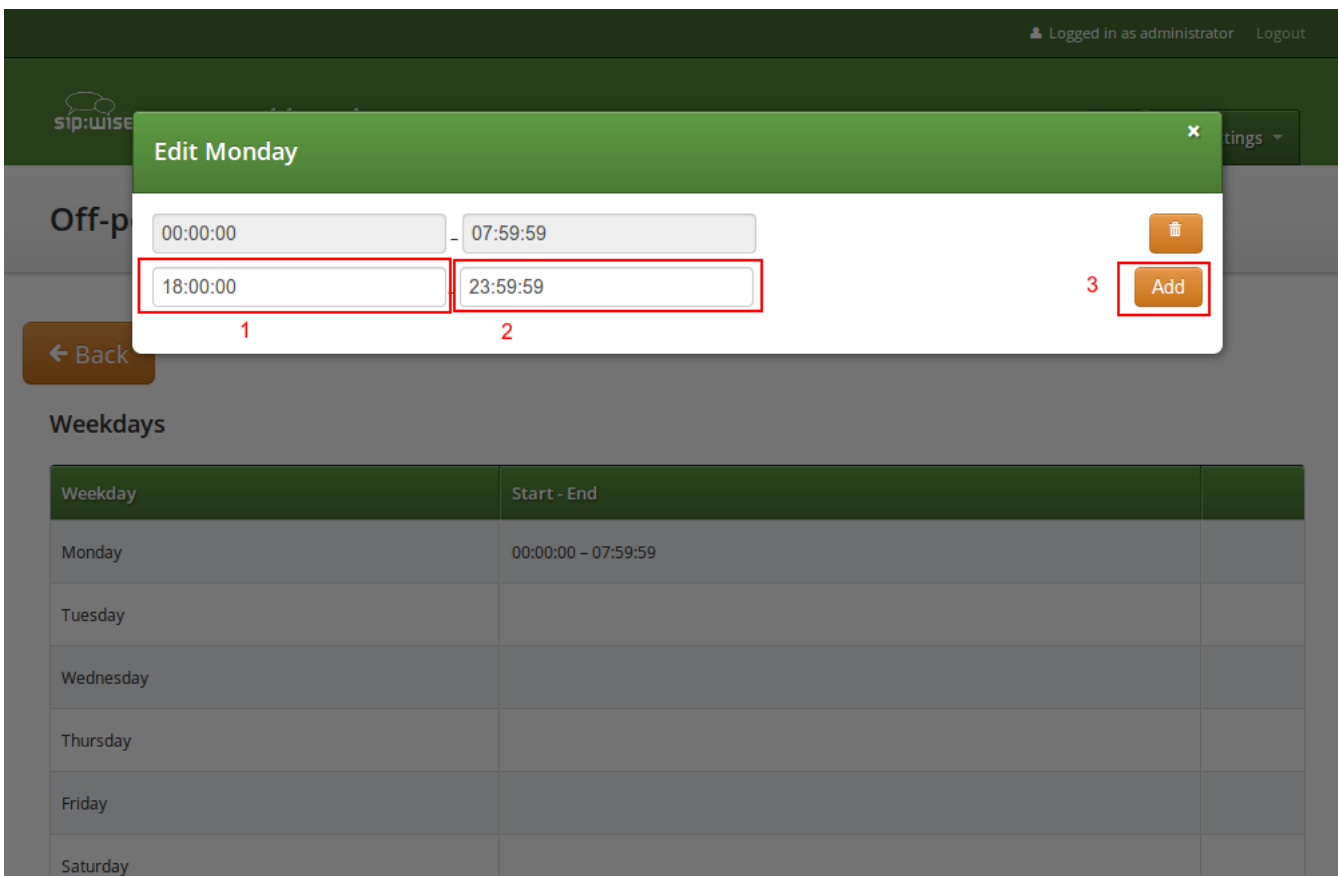

The screenshot shows the 'Edit Monday' modal in the Sipwise NGCP interface. The modal contains two input fields for start and end times, with '18:00:00' and '23:59:59' entered. A red box highlights these fields and the 'Add' button. A table below shows the current off-peak period for Monday from 00:00:00 to 07:59:59.

Weekday	Start - End
Monday	00:00:00 - 07:59:59
Tuesday	
Wednesday	
Thursday	
Friday	
Saturday	

To specify off-peak ranges based on calendar dates, click on *Create Special Off-Peak Date*. Enter a date in the form of YYYY-MM-DD hh:mm:ss into the *Start Date/Time* input field and *End Date/Time* input field to define a range for the off-peak period.

The screenshot shows a web interface for configuring date definitions. A modal dialog titled "Create Date Definitions" is open, containing two input fields:

- 1. Start Date/Time: 2013-12-24 00:00:00
- 2. End Date/Time: 2013-12-24 23:59:59

A "Save" button is located at the bottom right of the dialog, labeled with the number 3. Below the dialog, a table is visible with the following structure:

Weekday	Start - End
Monday	00:00:00 - 07:59:59 18:00:00 - 23:59:59
Tuesday	
Wednesday	
Thursday	
Friday	

## 6.2. Peak Time Call Rating Modes

### 6.2.1. Introduction to Call Rating Modes

The call rating engine component (*ngcp-rate-o-mat*) supports two different modes to consider configured off-peak/on-peak periods when calculating call costs:

- **Split-Peak-Parts mode:** CDRs reflecting calls which cross an off-peak/on-peak period transition will be split into two CDR fragments. This way it is possible for each fragment to exactly mark it as either on-peak or off-peak, and the CDR's *frag\_carrier\_onpeak*, *frag\_reseller\_onpeak* and *frag\_customer\_onpeak* fields can be populated accordingly.

CDRs that are entirely within either on-peak or off-peak periods are not split and show a value of 0 for their *is\_fragmented* field. CDR fragments are marked by the *is\_fragmented* field showing a value of 1. If the call is crossing *n* transitions, (*n+1*) fragments are created.

Apart from *is\_fragmented*, *\*\_onpeak* and *\*\_cost* fields, each fragment is a copy of the original CDR, except for *start\_time* and *duration* fields. The sum of durations of fragments is equal to the duration of the original CDR. Fragments are adjacent, so the *start\_time* of a fragment is equal to the end time (*start\_time* + *duration*) of the previous fragment.

- **Regular mode:** In regular mode, the costs are calculated by summing up init/follow interval ticks, and selecting on-peak or off-peak rates of the billing fee per tick. Resulting call costs will be identical to the sum of the costs of fragmented CDRs in Split-Peak-Parts mode, but now comprised of both on-peak and off-peak rates in a single value. Hence *frag\_carrier\_onpeak*, *frag\_reseller\_onpeak* and *frag\_customer\_onpeak* CDR fields cannot be provided.

## 6.2.2. Typical Use Cases for Call Rating Modes

The CDR fragmentation produced by **Split-Peak-Parts mode** can be useful when implementing:

- End-customer invoicing to **separate** call listings or costs by **off-peak and on-peak**
- Reports to compare sums of carrier and customer costs when fees with **different metering** (given by the fees' init and follow interval) are in effect

The process of the **regular mode** does not create additional CDRs, which has advantages in other situations:

- It is possible to **re-rate** CDRs, as there is no need to revert fragmentation.
- The concept of **one-CDR-per-call-leg** is kept, which simplifies external rating, reporting, call-flow visualisation etc.

## 6.2.3. Configuration of Call Rating Modes

The regular mode is enabled by default. To enable Split-Peak-Parts mode, set `rateomat.splitpeakparts` to 1 in `/etc/ngcp-config/config.yml` file.

## 6.3. Prepaid Accounting

In a normal post-paid accounting scenario, each customer accumulates debt in their billing account, which at the end of the billing interval is then billed to the customer. A *prepaid* billing profile reverses this sequence: the customer first has to provide credit to their account balance, and the costs for all calls are then deducted from that account balance. Once the balance reaches zero, no further calls from this customer are accepted, with the exception of free calls. Additionally, if the balance drops to zero while any calls are currently active, Sipwise C5 will disconnect those calls as soon as that happens.

With prepaid billing enabled, all details of the billing profile and all details of the billing fees behave as they normally do, including interval free time. If any interval free time is given, the free time will be used before the account's credit is.

### IMPORTANT

For technical reasons, the system can make the distinction between on-peak and off-peak times only at call establishment time. In other words, if the currently active call fee at the moment when the call is established is an off-peak fee, then the same off-peak fee will remain active for the whole length of this call, even if the call actually transitions into an on-peak fee (and vice versa).

### IMPORTANT

For technical reasons, prepaid billing can't charge local endpoint calls to Voicebox, VSC calls or calls to a Conference Room.

The Sipwise C5 platform offers advanced billing features which are especially designed for pre-paid billing scenarios. For details please visit [Billing Customizations](#) section of the handbook.

## 6.4. Fraud Detection and Locking

The Sipwise C5 supports a fraud detection feature, which is designed to detect accounts causing unusually high customer costs, and then to perform one of several actions upon those accounts. This feature can be enabled and configured through two sets of billing profile options described in [Creating Billing Profiles](#), namely the monthly (*fraud monthly limit*, *fraud monthly lock* and *fraud monthly notify*) and

daily limits (*fraud daily limit*, *fraud daily lock* and *fraud daily notify*). Either monthly/daily limits or both of them can be active at the same time.

As soon as call costs of a CDR are determined by rate-o-mat, database tables for bookkeeping daily and monthly sums are updated. Fraud lock levels will be applied instantly in case of a *fraud event* - that is when either the *fraud monthly limit* or *fraud daily limit* got exceeded. If **fraud lock** is set to anything other than *none*, it will lock the account's subscribers accordingly (e.g. if **fraud lock** is set to *outgoing*, the account will be locked for all outgoing calls).

A background script (managed by cron daemon, running every 10 minutes by default) automatically checks recent fraud events. An email will be sent to the address given by **fraud notify**, if set. The email will contain information about which account is affected, which subscribers within that account are affected, the current account balance and the configured fraud limit, and also whether or not the account was locked in accordance with the **fraud lock** setting. It should be noted that this email is meant for the administrators or accountants etc., and not necessarily for the customer.

### 6.4.1. Fraud Lock Levels

Fraud lock levels are various protection (and notification) settings that are applied to subscribers of a *Customer*, if fraud detection is enabled in the currently active billing profile and the *Customer's* daily or monthly fraud limit has been exceeded.

The following lock levels are available:

- none: no account locking will happen
- foreign calls: only calls within the subscriber's own domain, and emergency calls, are allowed
- all outgoing calls: subscriber cannot place any calls, except calls to emergency destinations
- incoming and outgoing: subscriber cannot place and receive any calls, except calls to emergency destinations
- global: same restrictions as at incoming and outgoing level, additionally subscribers are not allowed to access the Customer Self Care (CSC) interface
- ported: only automatic call forwarding, due to number porting, is allowed

#### IMPORTANT

You can override fraud detection and locking settings of a billing profile on a per-account basis via REST API or the Admin interface.

#### CAUTION

Accounts that were automatically locked by the fraud detection feature will **not** be automatically unlocked (e.g. if either a limit is lowered or the next day/month starts). This has to be done manually through the administration panel or through the provisioning interface.

#### NOTE

It is possible to fetch the list of fraud events and thus get fraud status of *Customers* by using the REST API and referring to the resource: `/api/customerfraudevents`.

#### NOTE

Apart from the daily fraud detection check service, Sipwise C5 also provides instant, "hard" locking for prepaid use cases, by means of billing profile packages. See [Billing Profile Packages](#) for reference.

## 6.5. Billing Customizations

The standard way of doing the billing—i.e. having fixed billing intervals of a calendar month, starting on the 1st day of month—may not fit all billing profiles and intervals that Sipwise C5 platform operators would like to use.

The Sipwise C5 supports alternate ways of defining billing profiles and intervals which are especially worthy for pre-paid scenarios. New functionality is covered by the following titles:

1. [Billing Networks](#)
2. [Profile Mappings Schedule](#)
3. [Profile Packages](#)
4. [Vouchers](#)
5. [Top-up](#)
6. [Balance Overviews](#)
7. [Usage Examples](#)

Subsequent sections will provide an introduction and configuration instructions to these advanced features of Sipwise C5.

### 6.5.1. Billing Networks

The idea is to dynamically select billing profiles (including fees) depending on the IP network the caller's SIP client is using to connect. The caller's IP is populated in a call's CDR, and effectively processed by:

- the rating engine component (*ngcp-rate-o-mat*) and the
- prepaid interception module (*libswrate*).

The billing profile for rating a call is identified by matching the source IP against network ranges linked to the customer contract's billing mappings records. This feature is sometimes also referred to as *roaming*.

A *Billing Network* is defined as a series of *network blocks* where each network block consists of *a single IP address or an IP subnet*. Blocks of a particular billing network can be defined by either IPv4, or IPv6 addresses but not mixed.

**Create Billing Network**

Reseller Search:

#	Name	Contract #	Status	
16	Demo Reseller	200	active	<input type="checkbox"/>

Showing 9 to 9 of 9 entries ← - 1 2 3 - →

Billing Network Name

Description

Billing Network Block  /

Figure 24. Creation of Billing Network

The new `/api/billingnetworks/` **REST API** resource makes it possible to manage billing networks. The example billing network that is shown in the figure above may be defined through the API with this JSON structure:

```
{ "blocks" : [ { "ip" : "10.0.1.0", // subnet: 10.0.1.0 .. 10.0.1.255
                "mask" : 24
              },
              { "ip" : "10.0.2.2" // single ip
              }
            ],
  "description" : "Some text",
  "name" : "Demo Billing Net 1", //unique per reseller
  "reseller_id" : 1
}
```

**Input validation** of the network blocks is automatically performed by Sipwise C5 during their definition in a way that it prevents specifying overlapping blocks by means of Interval Trees; billing networks themselves may overlap though.

Figure 25. Overlapping Block Prevention

## 6.5.2. Profile Mapping Schedule

Using the default settings related to billing when creating a new *Reseller* or *Customer* on the administrative web panel results in applying the standard billing profile mapping schedule: the same billing profile is always used.

### Definition of Profile Mapping Schedules

The idea of *billing profile mapping schedule* is to extend the billing mappings logic to utilize it as a schedule for billing profiles (and associated fees) for the *Customer* or *Reseller* contract. So far, billing mapping records provided only a history showing which profile was in effect at a given time in the past, which is for example required for delayed rating of calls.

Now it is also possible to define in advance, when specific billing profiles should become active in the future, e.g. to plan campaigns or special offers.

**Billing profile mappings** represent a schedule of overlapping time intervals with *Billing Profiles* and *Billing Networks*, which are assigned to (customer) contracts when creating or editing them.

*Mapping intervals* can be of type:

- open: no start time + no end time
- half-open:

left-open: no start time + definite end time

right-open: definite start time + no end time

- closed: definite start time + definite end time

### Schedule Example

id	Billing Profile Interval Schedule Example	Mai 2015			Jun 2015													
		29	30	31	1	2	3	4	5	6	7	8	9	10	11			
1	open: base/fallback (profile 1, no/any network)																	
2	closed: (profile 2 , network 1) from June, 2nd. – 4th.																	
3	right open: (profile 3 , network 1) starting on June, 1st.																	
4	right open: (profile 4 , network 2) starting on June, 1st.																	
5	closed: (profile 5 , no/any network) from June, 3rd. – 10th.																	

Figure 26. Profile Mapping Schedule Example

Applying the profile mapping schedule shown in the above figure will result in billing profiles being active as provided in the table below.

Table 1. Active Billing Profiles

Time	Web Panel shows	Rating		
		Caller IP in Network 1	Caller IP in Network 2	Caller IP in other network
May 30	Profile 1	Profile 1	Profile 1	Profile 1
June 1	Profile 4	Profile 3	Profile 4	Profile 1
June 2	Profile 2	Profile 2	Profile 4	Profile 1
June 5	Profile 5	Profile 3	Profile 4	Profile 5

### Configuration of Schedules

A *Customer's* default billing profile mapping can be changed to scheduled mappings when editing its properties, at the parameter "Set billing profiles", selecting: schedule (billing mapping intervals)

Edit Customer #202
✕

Set billing profiles schedule (billing mapping intervals) ▾

Billing Profiles	actual	Date	Billing Profile Name	Billing Network Name
✕	NULL-NULL		Demo-Billing-Profile	

Start

End

Profile

Search:

#	Reseller	Profile	
106	Demo Reseller	Demo Billi...	✕

Showing 49 to 49 of 49 entries

Network

Search:

#	Reseller	Network	
31	Demo Reseller	Demo Billi...	✕
33	Demo Reseller	Demo Billi...	<input type="checkbox"/>

Figure 27. Profile Mapping Schedule Creation

**TIP**

Assigning a *Billing Network* to a billing profile mapping is optional. Without selecting the network, the *Billing Profile* will be applied to all calls.

The profile mapping schedule assigned to a *Customer* is also listed among *Customer's* properties. See *Settings Customers Details Billing Profile Schedule*.

### Customer Details for #202 (Cloud PBX Account)

← Back
☰ Preferences
✎ Edit

✦ Expand Groups

Reseller

Contact Details

Billing Profile Schedule

actual	Date	Billing Profile Name	Prepaid	Billing Network Name
<input checked="" type="checkbox"/>	NULL-NULL	Demo Billing Profile	<input type="checkbox"/>	
<input type="checkbox"/>	2016-11-01T00:00:00 - 2016-12-31T00:00:00	Demo Billing Profile	<input type="checkbox"/>	Demo Billing Net 1
<input type="checkbox"/>	2017-01-01T00:00:00 - 2017-12-31T00:00:00	Demo Billing Profile	<input type="checkbox"/>	

Subscribers

PBX Groups

*Figure 28. Profile Mapping Schedule List*

#### NOTE

Profile mappings that started in the past, like the default one, are displayed with a strike-through font in order to indicate that those can not be modified.

The currently active mapping is depicted by a checked box.

### REST API for Profile Mapping Schedules

The `/api/customers/` API resource was extended to provide three different modes of defining profile mappings:

1. `billing_profiles` field: explicitly declare profile mappings in form of (billing profile, billing network, start time, stop time) tuples
2. `billing_profile_id` field (legacy API spec): a single profile mapping interval is appended (billing profile, no network / any caller IP respectively, starting now)
3. `profile_package_id` field: profile mappings starting now are appended by using lists of (billing profile, billing network) tuples from the given profile package

With regards to *Resellers*, the `/api/contracts/` API resource was enhanced as well, but supports method 1. and 2. only, and without billing networks.

### Mapping Intervals

Intervals can be of open, half-open (left-open, right-open) or closed type. When specifying profile mappings discretely, allowed interval types are restricted, depending on create/update situation:

*Table 2. Allowed Mapping Intervals*

Interval Type	Start	Stop	POST (create)	PUT / PATCH (update)
open	undefined	undefined	1..*	0
left-open	undefined	defined	0	0
right-open	> now()	undefined	*	*
closed	> now()	> start	*	*

### Example Profile Mapping

An example JSON structure for definition of profile mapping schedules shown in [Billing Profile Schedule List](#):

```
{ ...,
  "billing_profile_definition" : "profiles", // i.e. use
  'billing_profiles' field
  "billing_profiles" : [ { "network_id" : "236",
    "profile_id" : "236",
    "start" : "2016-11-01 00:00:00",
    "stop" : "2016-12-31 00:00:00"
  }, // closed future interval, with network
  { "network_id" : null,
    "profile_id" : "237",
    "start" : "2017-01-01 00:00:00",
    "stop" : "2017-12-31 00:00:00"
  } ], // closed future interval, without network

  "contact_id" : 141,
  ...
}
```

### 6.5.3. Profile Packages

By introducing billing profile packages, general billing parameters can be defined for a customer contract:

- Balance interval duration (regular/constant or aligned to top-up events)
- The first interval's start date
- The cash-balance carry-over/discard behaviour upon interval transitions
- Subscriber lock levels and profile sets to get applied upon:
  - top-up
  - balance threshold underrun
- Initial balance and billing profiles

*Profile Packages* are fundamental for pre-paid billing scenarios, since in such a billing scheme the traditional, fixed monthly periods prove to be insufficient to cover the business needs of Sipwise C5 platform operator. As an example: pre-paid subscribers typically have their "billing periods" between account balance top-ups.

## Elements of Profile Packages

A *Profile Package* consists of various elements that will be discussed in subsequent sections of Sipwise C5 handbook. In order to set the parameters of a profile package one must navigate to: *Settings Profile Packages Create Profile Package*, or alternatively, in order to update an existing profile package: select the package and press *Edit* button.

### Basic Balance Intervals Setup

- Interval duration (n hours, days, weeks, months)
- Interval start mode:

1st of month (1st): billing interval is 1 calendar month; this is the default for each *Customer* created on Sipwise C5 platform

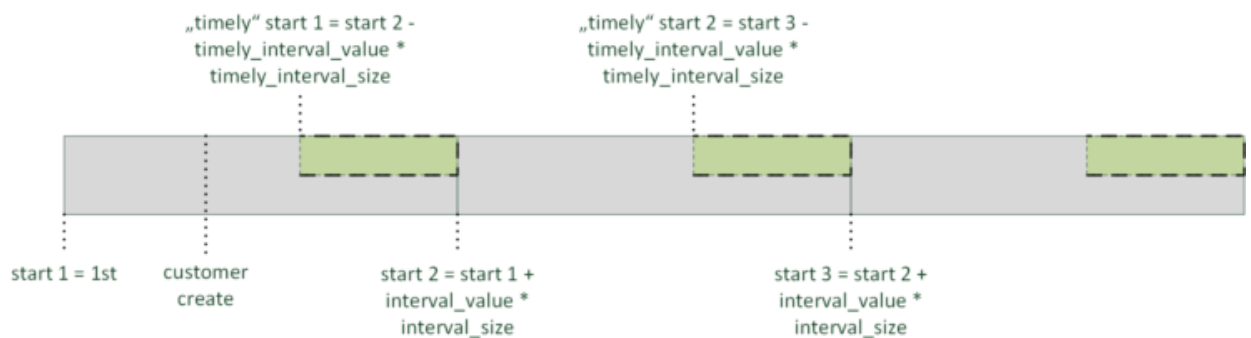

Figure 29. Interval Start Mode: 1st

upon customer creation (create): (the initial) billing interval starts when the *Customer* is created

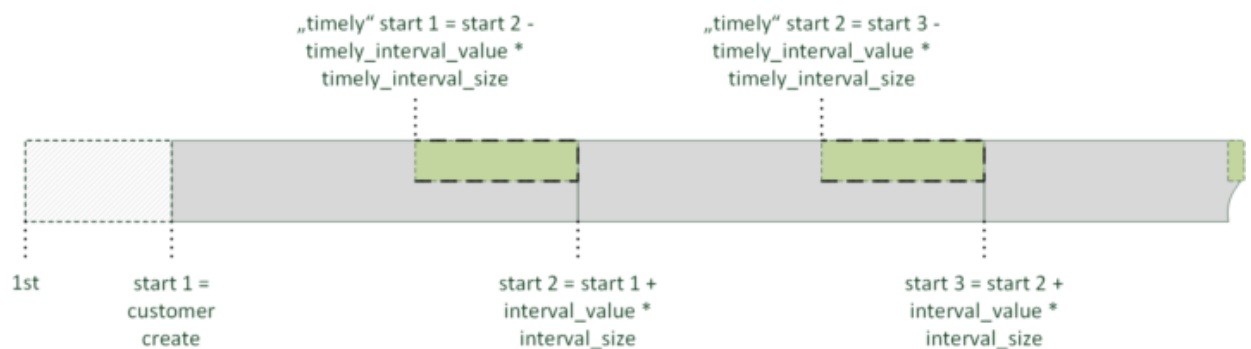

Figure 30. Interval Start Mode: create

upon topup (topup\_interval): interval starts at *first topup* event and its length is defined by interval duration parameter of the profile package

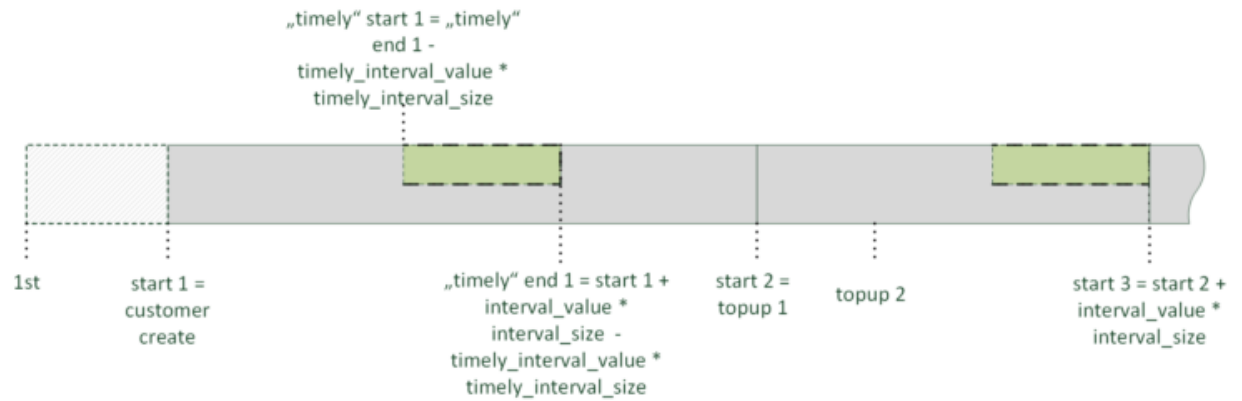

Figure 31. Interval Start Mode: topup-interval

intervals from topup to topup (topup): interval starts at *any topup* event and its length is defined by interval duration parameter of the profile package; intervals can overlap in this case

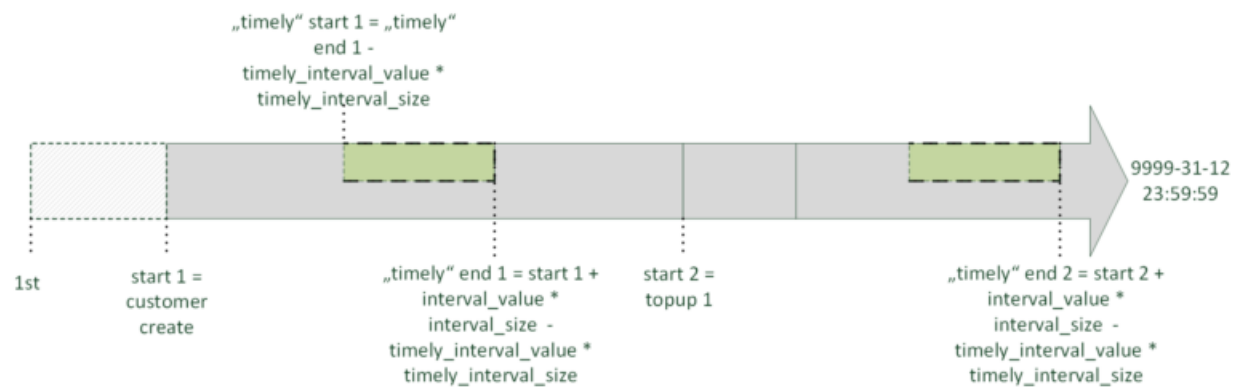

Figure 32. Interval Start Mode: topup

- Initial balance: the initial value of account balance (e.g. every new customer gets 5 Euros as a starting bonus)

### Balance Carry Over

- Carry Over: balance carry over behaviour upon interval transitions:
  - carry-over: always keep balance
  - carry-over only if topped-up timely: keep balance in case of a *timely* top-up only; where **timely** means the topup happens within a pre-defined time span before the end of the balance interval
  - discard: discard balance at the end of each interval
- Timely Duration: duration of the *timely* period
- Discard balance after intervals: for how many balance intervals the remaining account balance is kept before its disposal

### Underrun Settings

- Underrun lock threshold: when account balance reaches this amount the subscriber will be locked to a restricted set of services
- Underrun lock level: this level of services will apply when an account balance underruns

don't change: no change in the available set of services

no lock: all services are available

foreign: only calls within subscriber's own domain are allowed

outgoing: all outgoing calls are prohibited

all calls: all calls (incoming + outgoing) are prohibited

global: all calls + access to Customer Self Care web interface are prohibited

ported: only automatic call forwarding, due to number porting, is allowed

- Underrun profile threshold: when account balance reaches this amount the *Underrun Billing Profile* will be applied

### **Basic Top-up Settings**

- Top-up lock level: subscriber lock (unlock) levels to apply upon top-up event
- Service charge: (always) subtract this value from the voucher amount, if topup happens via the usage of a voucher

### **Profile mappings**

A lists of (billing profile, billing network) tuples for appending profile mappings:

- Initial Billing Profile: when creating or manually changing the customers package (initial\_profiles)
- Underrun Billing Profile: when the balance underruns a cash threshold (underrun\_profiles)
- Top-up Billing Profile: when the customer tops-up using a voucher associated with the package (topup\_profiles)

### **Examples**

#### **Profile Package Configuration**

1. Definition of basic profile package parameters

**Create Profile Package**
✕

Name

Description

Initial Balance

Initial Billing Profile/Network

Profile

Search:

#	Reseller	Profile	
106	Demo Reseller	Demo Billi...	<input type="checkbox"/>
107	Demo Reseller	Demo Pre-p...	<input checked="" type="checkbox"/>
109	Demo Reseller	Demo Pre-p...	<input type="checkbox"/>
111	Demo	Demo Pre-p...	<input type="checkbox"/>

Network

Search:

#	Reseller	Network	
1	default	test billi...	<input type="checkbox"/>
3	default	test billi...	<input type="checkbox"/>
7	default	test ipv6 ...	<input type="checkbox"/>
9	default	test ipv6 ...	<input type="checkbox"/>

Showing 1 to 4 of 14 entries

Figure 33. Basic Profile Package Parameters

2. Definition of balance interval and carry-over behaviour

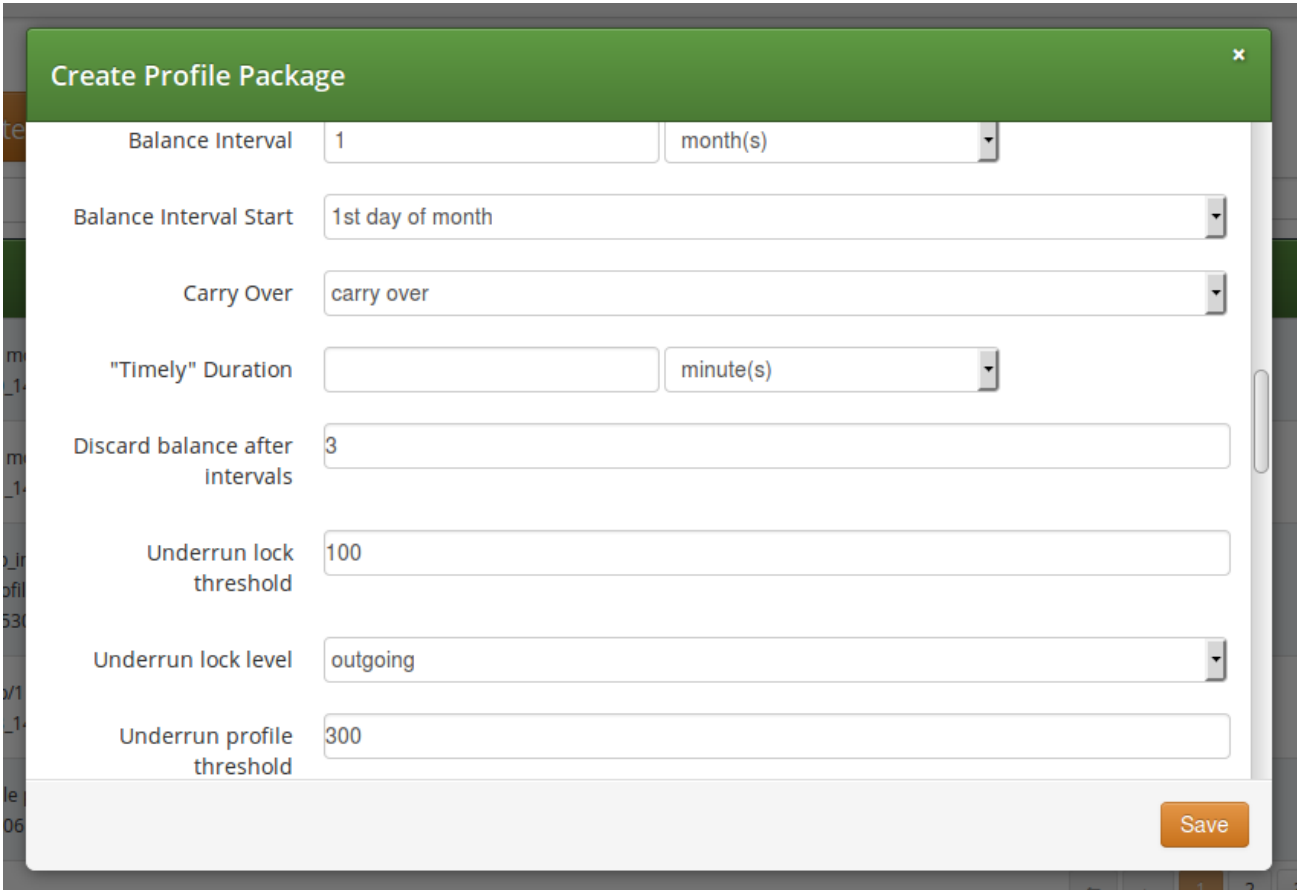

The screenshot shows a 'Create Profile Package' dialog box with the following fields and values:

Field	Value
Balance Interval	1 month(s)
Balance Interval Start	1st day of month
Carry Over	carry over
"Timely" Duration	minute(s)
Discard balance after intervals	3
Underrun lock threshold	100
Underrun lock level	outgoing
Underrun profile threshold	300

A 'Save' button is located at the bottom right of the dialog box.

Figure 34. Balance Interval and Carry-over

### 3. Definition of balance underrun parameters

**Create Profile Package**
✕

Underrun lock threshold

Underrun lock level

Underrun profile threshold

Underrun Billing Profile/Network

Profile

Search:

#	Reseller	Profile	
113	Demo Reseller	Demo Pre-p...	<input type="checkbox"/>
115	Demo Reseller	Demo Pre-p...	<input checked="" type="checkbox"/>
117	Demo Reseller	Demo Pre-p...	<input type="checkbox"/>

Network

Search:

#	Reseller	Network	
1	default	test billi...	<input type="checkbox"/>
3	default	test billi...	<input type="checkbox"/>
7	default	test ipv6 ...	<input type="checkbox"/>
9	default	test ipv6 ...	<input type="checkbox"/>

Figure 35. Balance Underrun Parameters

#### 4. Definition of top-up settings

**Create Profile Package**
✕

Top-up lock level no lock (unlock)

Service Charge 50

Top-up Billing Profile/Network

Profile

Search: demo

#	Reseller	Profile	
106	Demo Reseller	Demo Billi...	<input type="checkbox"/>
107	Demo Reseller	Demo Pre-p...	<input type="checkbox"/>
109	Demo Reseller	Demo Pre-p...	<input type="checkbox"/>
111	Demo Reseller	Demo Pre-p...	<input checked="" type="checkbox"/>

Network

Search:

#	Reseller	Network	
1	default	test billi...	<input type="checkbox"/>
3	default	test billi...	<input type="checkbox"/>
7	default	test ipv6 ...	<input type="checkbox"/>
9	default	test ipv6 ...	<input type="checkbox"/>

Showing 1 to 4 of 14 entries

←
←
1
2
3
4
→
→

Showing 1 to 4 of 7 entries (filtered from 55 total)

Remove
Save

Figure 36. Balance Top-up Settings

#### 5. Assigning a profile package to a customer

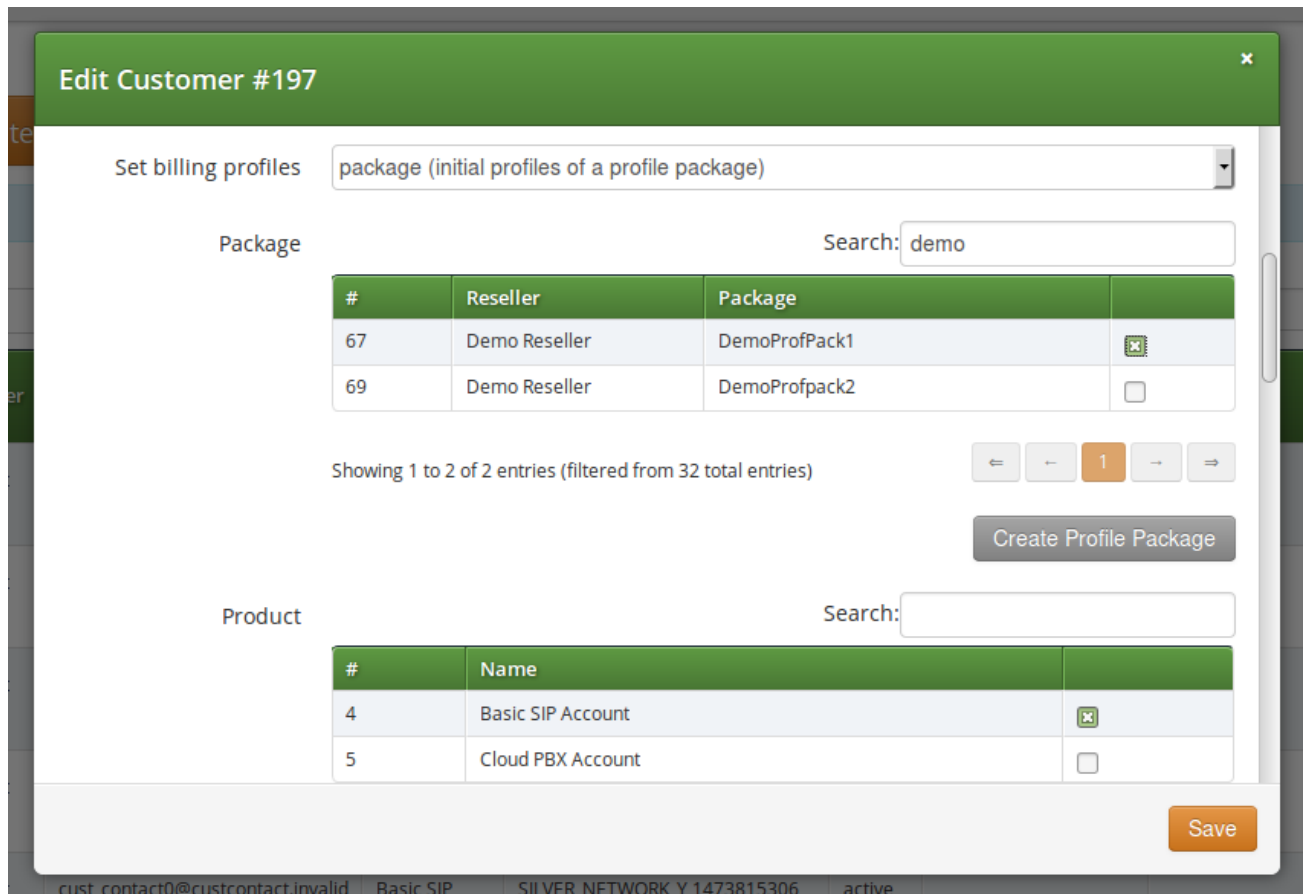

Figure 37. Assigning Profile Package to Customer

**Interval start mode: top-up interval; carry-over: timely**

Profile package setup:

- initial\_balance: 1.0 euro
- balance\_interval: 30 "day(s)"
- interval\_start\_mode: "topup\_interval"
- carry\_over\_mode: "timely"
- timely\_duration: 12 "day(s)"
- underrun\_lock\_threshold: 0.7 euro
- underrun\_profile\_threshold: 5.0 euro
- underrun\_lock\_level:...

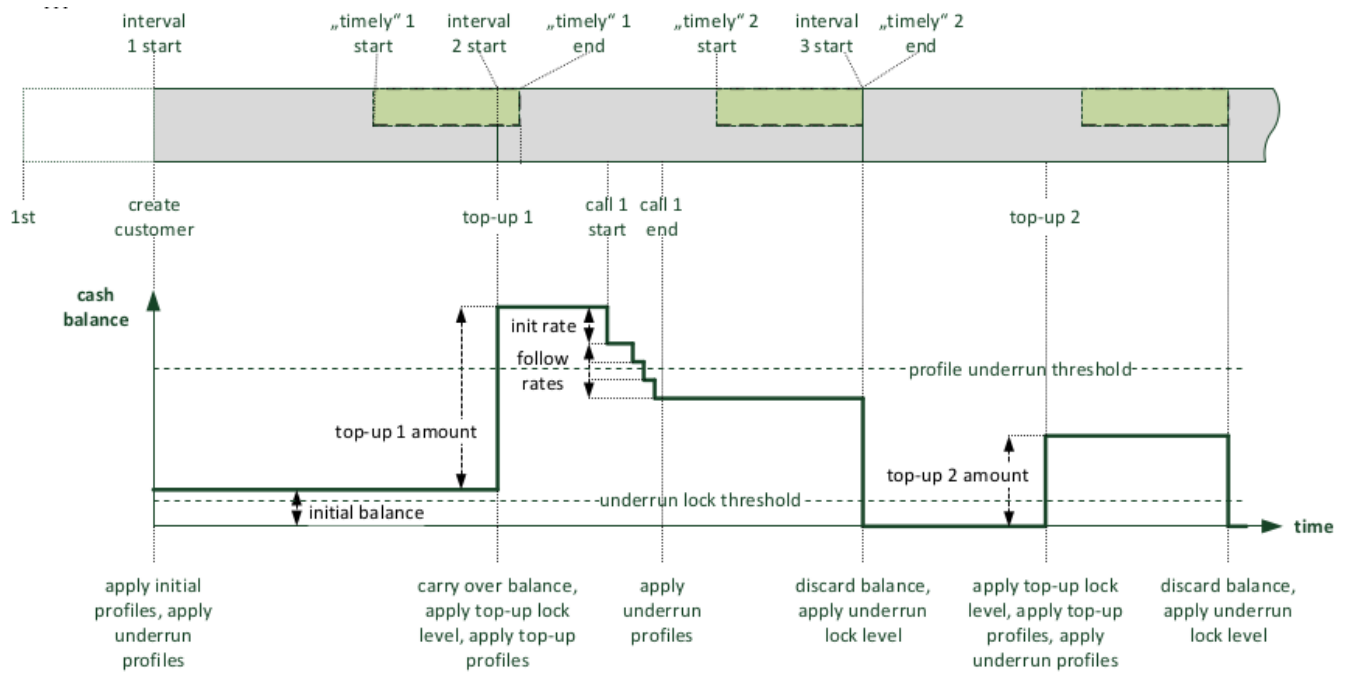

Figure 38. Example: Top-up Interval and Timely Carry-over

**Interval start mode: top-up to top-up; carry-over: always**

- initial\_balance: 1.0 euro
- balance\_interval: 30 "day(s)"
- interval\_start\_mode: "topup"
- carry\_over\_mode: "carry-over"
- notopup\_discard\_intervals: 1
- underrun\_lock\_threshold: 0.7 euro
- underrun\_profile\_threshold: 5.0 euro
- underrun\_lock\_level:...

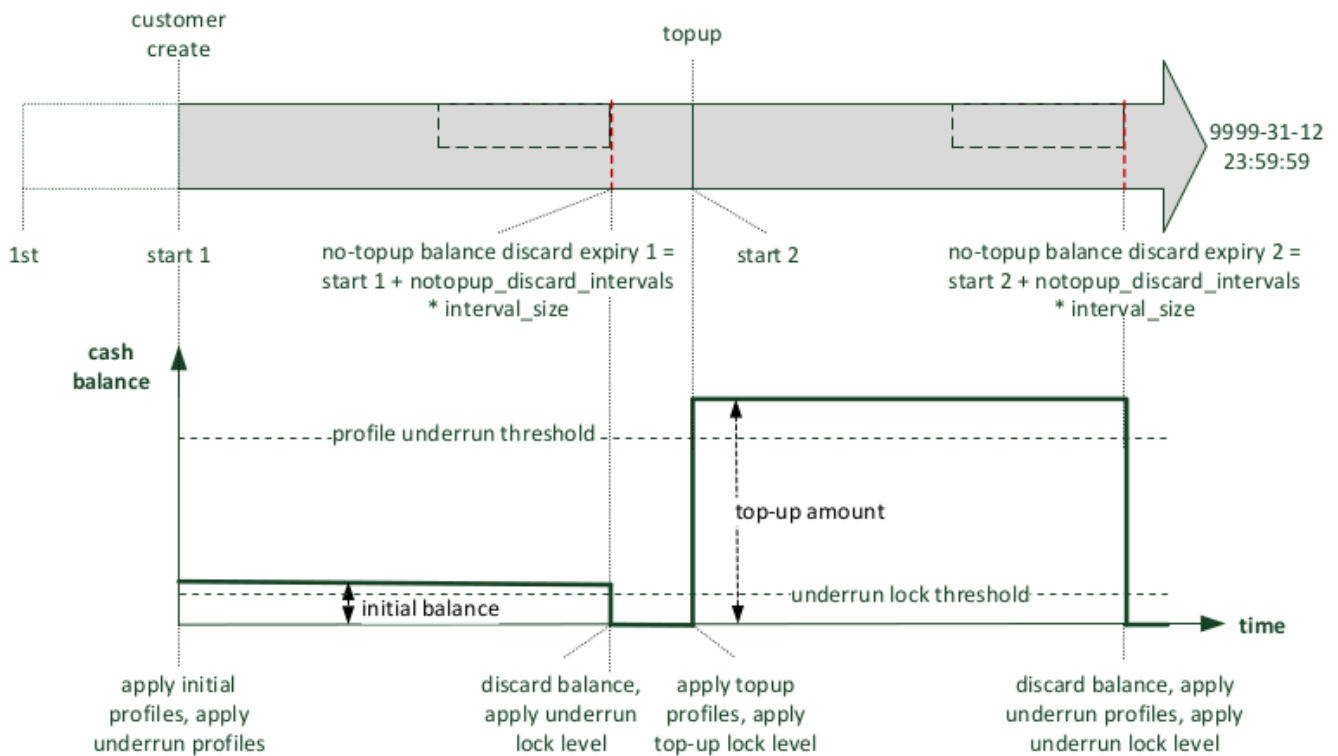

Figure 39. Example: Top-up and Always Carry-over

## REST API

The new `/api/profilepackages/` REST API resource makes it possible to manage billing profile package container entities, that aggregate settings of profile packages.

A sample JSON structure follows:

```
{
  "reseller_id" : 1,
  "status" : "active",
  "name" : "demo profile package",
  "description" : "package for 10€ ...",
  "balance_interval_start_mode" : "1st",
  "balance_interval_value" : 1,
  "balance_interval_unit" : "month",
  "carry_over_mode" : "carry_over",
  "timely_duration_unit" : null,
  "timely_duration_value" : null,
  "initial_balance" : 0,
  "initial_profiles" : [...], // required default, e.g. same as
  „topup_profiles“
  "notopup_discard_intervals" : null,
  "underrun_lock_threshold" : 0,
  "underrun_lock_level" : 4,
  "underrun_profile_threshold" : 5,
  "underrun_profiles" : [...],
  "service_charge" : 10,
}
```

```

"topup_lock_level" : null,
"topup_profiles" : [ {
    "network_id" : null, // any network
    "profile_id" : 29
  },
  {
    "network_id" : 2, // a specific billing network
    "profile_id" : 30
  },
],
...
}

```

### 6.5.4. Vouchers

Vouchers are a typical mean of topping-up an account balance in pre-paid billing scenarios.

The definition of a voucher in the database may succeed via:

- manual entry of voucher data on the administrative web panel or through the REST API
- bulk-uploading of vouchers using a CSV (comma separated value) formatted file

In order to manage vouchers the administrator has to navigate to: *Settings Vouchers Create Billing Voucher* or select an existing one and press *Edit* button.

**Billing Vouchers**

← Back
★ Create Billing Voucher
★ Upload Vouchers as CSV

Billing voucher successfully created

Show 10 entries
Search: demo

#	Code	Amount	Reseller	Profile Package	For Contract #	Valid Until	Used At	Used By Subscriber #
25	DEMO_Voucher_Profpack1_001	1000	Demo Reseller	DemoProfPack1		2017-12-31 23:59:59		
27	DEMO_Voucher_Profpack2_001	2000	Demo Reseller	DemoProfpack2		2018-06-30 23:59:59		

Showing 1 to 2 of 2 entries (filtered from 14 total entries)
← 1 →

Figure 40. List of Vouchers

### Properties of Vouchers

- Code: the unique code of the voucher which assures that a voucher can be used only once; this property is encrypted and displayed on the web panel to authorized users only
- Amount: the amount of money the voucher represents
- Valid until: end of validity period

**Create Billing Vouchers**

Reseller Search: demo

#	Name	Contract #	Status
16	Demo Reseller	200	active

Showing 1 to 1 of 1 entries (filtered from 9 total entries)

Create Reseller

Code: DEMO\_Voucher\_Profpack1\_001

Amount: 1000

Valid until: 17-12-31

Customer Search:

#	Reseller	Contact Email	External #	Status
---	----------	---------------	------------	--------

Save

Figure 41. Voucher's Main Properties

Setting following properties of a voucher is optional:

- Customer: the *Customer* whom the voucher will be assigned to; subscribers of other customers can not redeem the voucher
- Package: vouchers may be associated with profile packages; if done so, some changes will be applied to the *Customer* for whom the voucher is redeemed with the top-up event:
  - applying top-up profile mappings starting with the time of the top-up
  - subtracting the new package's service charge from the voucher amount
  - resizing the current balance interval for a gapless transition, if the new package has a different interval start mode (e.g. from "create" to "1st")
  - if a new balance interval starts with the top-up, the carry-over mode of the customer's previous package applies

**Create Billing Vouchers**

Customer Search:

#	Reseller	Contact Email	External #	Status	
7	default	customer.test@spce.test		active	<input type="checkbox"/>
13	default	cust_contact0@custcontact.invalid		active	<input type="checkbox"/>
15	default	cust_contact0@custcontact.invalid		active	<input type="checkbox"/>
17	default	cust_contact0@custcontact.invalid		active	<input type="checkbox"/>

Showing 1 to 4 of 71 entries

Create Contract

Package Search:

#	Reseller	Package	
69	Demo Reseller	DemoProfpack2	<input type="checkbox"/>
67	Demo Reseller	DemoProfPack1	<input checked="" type="checkbox"/>

Save

Figure 42. Voucher: Customer and Profile Package

## REST API

Vouchers can be created and managed using the `/api/vouchers/` REST API resource. This resource restricts invasive operations (POST, PUT, PATCH, DELETE) to authorized users.

```
{
  "amount" : 1000,
  "customer_id" : null, //do not restrict to a specific customer
  "valid_until" : "2017-06-05 23:59:59",
  "package_id" : "571", //switch to profile package
  "reseller_id" : 1,
  "code" : "SILVER_1_1437974823"
}
```

### 6.5.5. Top-up

A customer's administrator or subscriber can perform a top-up to increase the contract's cash balance. The Sipwise C5 platform supports two means of topping-up the balance:

1. Top-up Cash: Directly specify the cash amount to add
2. Top-up Voucher: Specify the code of a voucher, which was set up in advance

The Sipwise C5 platform provides 2 interfaces to perform top-ups:

1. through the REST API: use a CRM or third-party REST-API Broker (which i.e. coordinates with an App-Store purchase process) to finally instruct Sipwise C5 to perform a top-up. This is the **recommended** method.
2. through the administrative web interface:

One has to select the *Customer*, then *Details Contract Balance* and finally press *Top-up Cash* or *Top-up Voucher*.

### Top-up Cash

When doing top-up with cash one needs to supply the amount of top-up in the currency of the customer contract. Optionally one can assign a *Profile Package* to the top-up event which will activate that profile package for the customer.

The screenshot shows the 'Edit Settings' window with the following elements:

- Amount:** A text input field containing the value '12'.
- Package:** A section with a search bar and a table of available packages.

#	Reseller	Package	
67	Demo Reseller	DemoProfPack1	<input checked="" type="checkbox"/>
69	Demo Reseller	DemoProfpack2	<input type="checkbox"/>

Below the table, it says 'Showing 1 to 2 of 2 entries' and includes navigation arrows. At the bottom right, there is a 'Perform top-up' button.

Figure 43. Balance Top-up with Cash

It is also possible to perform top-up through the **REST API**: POST /api/topupcash

```
{
  "subscriber_id" : "73",
  "amount" : 100,
  "package_id" : null,
}
```

### Top-up Voucher

Selecting *Top-up Voucher* option will provide a simple list of available vouchers from which the

administrator can choose the voucher. If a *Profile Package* is assigned to the voucher, that package will be activated for the customer on the top-up event.

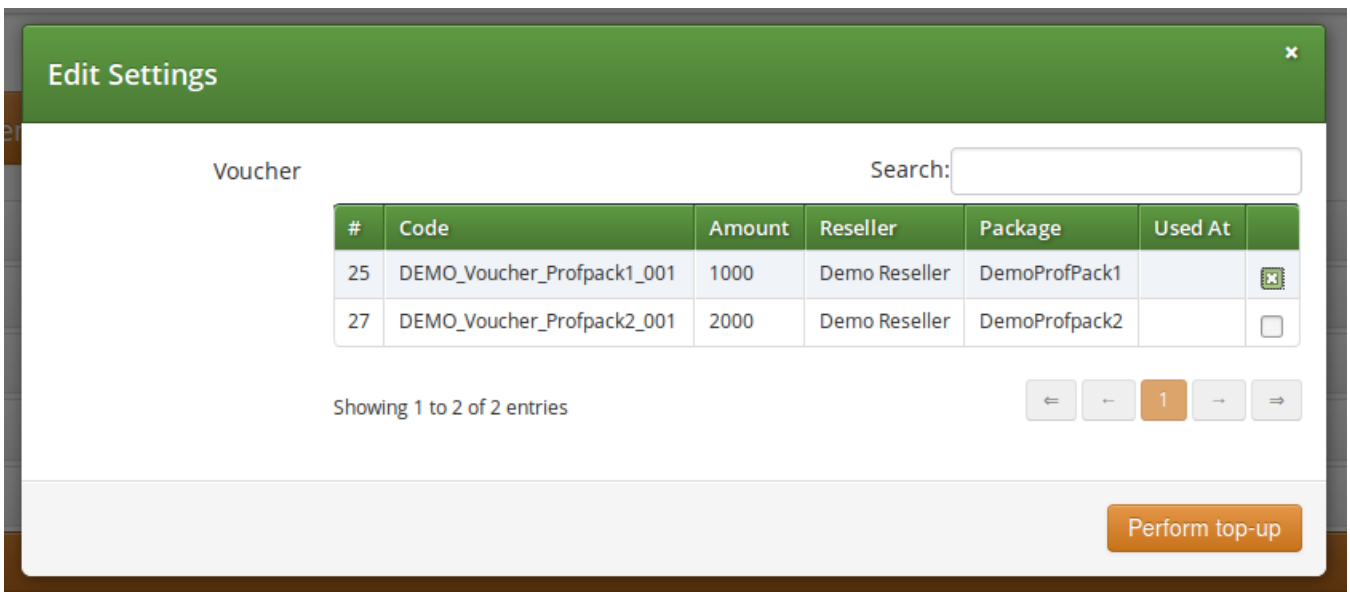

Figure 44. Balance Top-up with Voucher

It is also possible to perform top-up through the **REST API**: POST /api/topupvouchers

```
{
  "subscriber_id" : "73",
  "code" : "SILVER_1_1437974390"
  "request_token" : "uuid_from_3rdparty_relay" // optional request
  identifier                                     // for lookups in the
  top-up log
}
```

### 6.5.6. Balance Overviews

The actual contract balance and logs of top-up or balance interval change events are a kind of financially important information and that's why those are provided on the administrative web interface for each customer. One should navigate to: *Settings Customers select the customer Details*.

The various information details available on the web interface are discussed in subsequent sections of the handbook.

#### Contract Balance

This part of the overviews shows the actual financial state of the customer's balance and the current profile package and balance interval.

Sound Sets

Contract Balance

↻ Top-up Voucher
↻ Top-up Cash
🔗 Set Cash Balance

Cash balance	11.50	Debit	0.00
Free time balance	0	Free time spent	0

Interval from	2016-10-01T00:00:00	Interval to	2016-10-31T23:59:59
"Timely" top-ups from		"Timely" top-ups to	
Balance will be discarded, if no top-up happens until		2017-02-01T00:00:00	

Actual profile package	DemoProfPack1	Actual billing profile	Demo Pre-paid Topup 1
Balance threshold when underrun profiles get applied	1.00	Balance threshold when subscribers will be locked	1.00

Balance Intervals

Top-up Log

Figure 45. Contract Balance Status

Another functionality assigned to *Contract Balance* section is the manual top-up. Both top-up with cash and top-up with voucher can be performed from here.

## Balance Intervals

This table shows the balance intervals that have been in use, including the current interval.

Sound Sets

Contract Balance

Balance Intervals

Show  entries
Search:

From	To	Cash	Debit	#Top-ups	#Timely Top-ups	Underrun detected (Profiles)	Underrun detected (Lock)
2016-09-01 00:00:00	2016-09-30 23:59:59	0.00	0.00	0	0		
2016-10-01 00:00:00	2016-10-31 23:59:59	11.50	0.00	1	0	2016-10-07 15:05:26	2016-10-07 15:05:26

Showing 1 to 2 of 2 entries

Top-up Log

Fraud Limits

Figure 46. List of Balance Intervals

**Content** of the balance intervals table is:

- From, To: starting and end points of the time interval
- Cash: the contract's cash balance value at the end of the interval (former int.), or currently (actual

int.)

- Debit: the total spent amount of money in the actual interval

### NOTE

While "Cash" shows the remaining amount, "Debit" shows the spent amount. With a post-paid billing scenario only "Debit" field would be populated, with pre-paid both fields will display an amount.

- No. of Top-ups: how many top-up events happened within the interval
- No. of Timely Top-ups: how many timely top-up events happened within the interval
- Underrun detected (Profiles or Lock): the time of last underrun event when either an underrun billing profile, or a subscriber lock was activated

## Top-up Log

Each successful or failing top-up request has to be logged. The log records represent an audit trail and reflect any data changes in the course of the top-up request.

In case of an error during the top-up operation the error message and any parseable fields of failed top-up attempts is recorded.

Contract Balance											
Balance Intervals											
Top-up Log											
Show	5	entries	From Date:	<input type="text"/>	To Date:	<input type="text"/>	Search:	<input type="text"/>			
Timestamp	Subscriber	Type	Outcome	Message	Voucher ID	Amount	Balance before	Balance after	Package before	Package after	
2016-10-07 15:11:29		cash	ok			11.50	0.00	11.50	DemoProfPack1	DemoProfPack1	
Showing 1 to 1 of 1 entries											<input type="button" value="←"/> <input type="button" value="1"/> <input type="button" value="→"/>
Fraud Limits											
Invoices											

Figure 47. Balance Top-up Log

**Content** of the top-up log table is:

- Timestamp: when the top-up happened
- Subscriber: the ID of the subscriber who performed the top-up
- Type: cash or voucher
- Outcome: ok or failed
- Message: error message, if Outcome="failed"
- Voucher ID: ID of voucher, if Type="voucher"
- Amount: the amount by which the balance was modified (after the *Service Charge* was subtracted from the voucher's value)
- Balance before: balance's value before top-up
- Balance after: balance's value after top-up

- Package before: the name of the *Profile Package* that was active before top-up
- Package after: the name of the *Profile Package* that became active after top-up

The top-up log table can also be queried using the readonly `/api/topuplogs` **REST API** resource.

An example of the response:

```
{
  "_embedded" : {
    "ngcp:topuplogs" : [{
      "_links" : {...},
      "amount" : null,
      "cash_balance_after" : null,
      "cash_balance_before" : null,
      "contract_balance_after_id" : null,
      "contract_balance_before_id" : null,
      "contract_id" : 2565,
      "id" : 373,
      "lock_level_after" : null,
      "lock_level_before" : null,
      "message" : ..., //error reason
      "outcome" : "failed",
      "package_after_id" : null,
      "package_before_id" : null,
      "profile_after_id" : null,
      "profile_before_id" : null,
      "request_token" : "1444956281_6", // = "panel" for panel UI
      requests
      "subscriber_id" : 1804,
      "timestamp" : "2015-10-16 02:45:19",
      "type" : "voucher", // "cash" or "voucher"
      "username" : "administrator",
      "voucher_id" : null }]
    },
    "_links" : { ... },
    "total_count" : 1
  }
}
```

### 6.5.7. Usage Examples

After getting to know the concepts of customized billing solution on Sipwise C5 platform, it's worth seeing some practical examples for the usage of those advanced features.

The starting point is the setup of *Profile Packages* for our fictive customers: A, B and C. There are 4 different packages defined, with corresponding vouchers:

- **Initial:**

- Balance interval: 1 month

- Timely duration: 1 month

Interval start mode: topup\_interval

Carry-over mode: carry\_over\_timely

• **Silver:**

Balance interval: 1 month

Timely duration: 1 month

Interval start mode: "topup\_interval"

Carry-over mode: "carry\_over\_timely"

Service charge: 2 EUR

Underrun lock level: "no lock"

Voucher value: 10 EUR

• **Gold:**

Balance interval: 1 month

Interval start mode: "topup\_interval"

Carry-over mode: "carry\_over"

Service charge: 5 EUR

Underrun lock level: "no lock"

Voucher value: 20 EUR

• **Extension:**

Balance interval: 1 month

Timely duration: 1 month

Interval start mode: "topup\_interval"

Carry-over mode: "carry\_over\_timely"

Service charge: 2 EUR

Underrun lock level: "no lock"

Voucher value: 2 EUR

### Customer A—Silver Package

1. Customer A tops up 10 EUR with a "silver" voucher. 2 EUR are deducted as service charge. Remaining balance is 8 EUR starting on the date of the top-up.
2. Customer A doesn't top-up balance within the next month, so remaining balance is set to 0 after one month, and billing profiles and lock levels are set to the balance-underrun definition of the "silver" package.

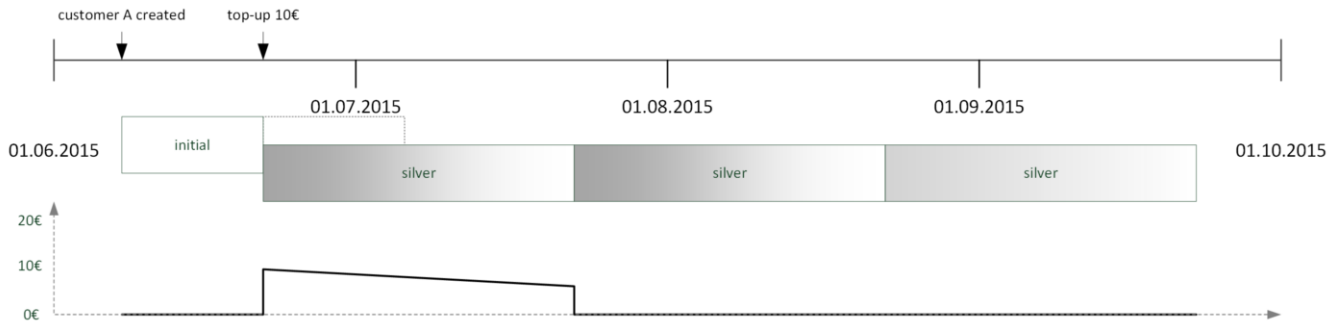

Figure 48. Usage Example: Silver Package

### Customer B—Silver and Extension Package

1. Customer B tops up 10 EUR with the "silver" voucher. 2 EUR are deducted as service charge. Remaining balance is 8 EUR starting on the date of the top-up.
2. Customer B tops up 2 EUR using an "extension" voucher on the last day. 2 EUR are deducted as service charge and the interval is extended for one month, carrying over his old balance.
3. Customer B doesn't top-up balance within the next month, so remaining balance is set to 0 after the month, and billing profiles and lock levels are set to the balance-underrun definition of the "extension" package.

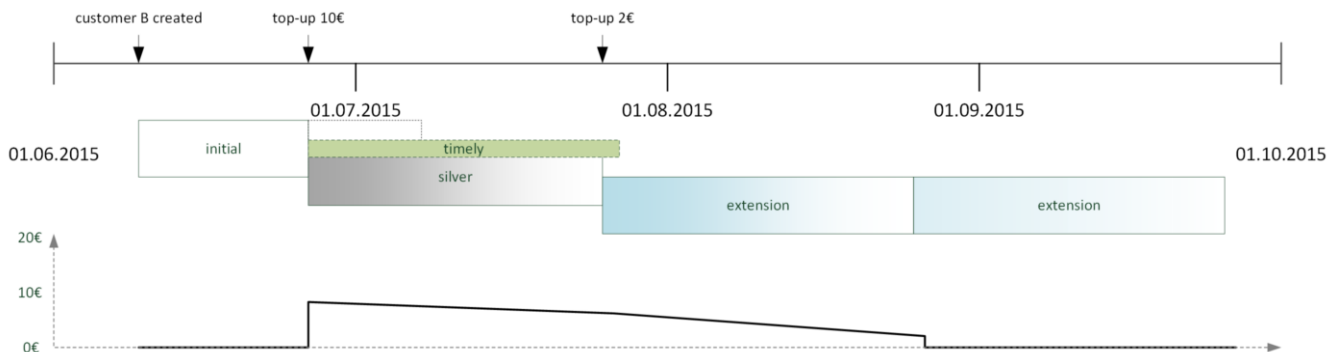

Figure 49. Usage Example: Silver + Extension Package

### Customer C—Gold Package

Customer C tops up 20 EUR with the "gold" voucher. 5 EUR are deducted as service charge. Remaining balance is 15 EUR starting on the date of the top-up. Balance is carried over after each month until used up.

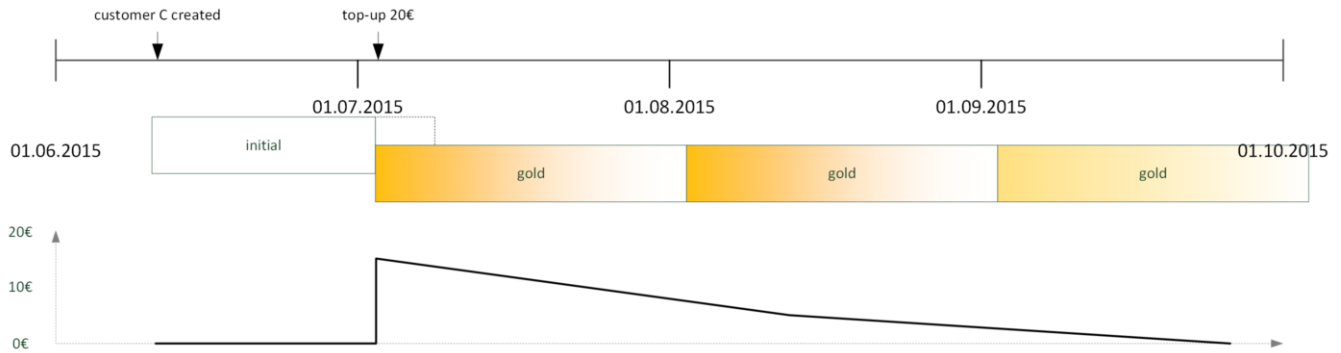

Figure 50. Usage Example: Gold Package

## 6.6. Notes on Billing and Call Rating

### Cash balance with post-paid billing profile

Customers with a post-paid billing profile may have a positive account cash balance value. This is the regular case when using a post-paid billing profile showing a *free cash* greater than '0'.

#### TIP

You can set the free cash (and the free time) in the billing profile. The account balance will be set and managed (i.e. refilled or carried over) automatically for subsequent balance intervals.

In case the account has a positive cash balance, the cost of the call will be deducted from that balance and not considered as additional cost of that particular call for the customer.

#### IMPORTANT

The rating engine (*ngcp-rate-o-mat*) in Sipwise C5 will write '0' instead of the real cost of a call in the CDR, if the source customer's (who initiated the call) account has a positive cash balance! The purpose of this is to reflect the usage of free cash in the CDR for the particular call.

#### NOTE

It might happen, for instance, that a customer's billing profile is changed from pre-paid to post-paid, and the customer already had a positive cash balance on his account. In that case the same call rating mechanism is involved as for the free cash.

## 6.7. Billing Data Export to Files

Legacy billing data export is done using CSV (*comma separated values*) files which are generated by a *cron* job and may be downloaded from the platform using the *cdlexport* user which has been created during the installation.

There are two types of exports. One is *CDR* (Call Detail Records) used to charge for calls made by subscribers, and the other is *EDR* (Event Detail Records) used to charge for provisioning events like enabling certain features.

### 6.7.1. Glossary of Terms

Billing records contain fields that hold data of various entities that play a role in the phone service offered by Sipwise C5. For a better understanding of billing data please refer to the glossary provided here:

- **Account:** the customer's account that is charged for calls of its subscriber(s)
- **Carrier:** a SIP peer that sends incoming calls to, or receives outgoing calls from NGCP. A carrier may charge fees for the outgoing calls from Sipwise C5 (outbound billing fee), or for the incoming calls to Sipwise C5 (inbound billing fee).
- **Contract:** the service contract that represents a customer, a reseller or a SIP peer; a contract on Sipwise C5 contains the billing profile (billing fees) too
- **Customer:** the legal entity that represents any number of subscribers; this entity receives the bills for calls of its subscriber(s)
- **Provider:** either the reseller that holds a subscriber who is registered on NGCP, or the SIP peer that handles calls between an external subscriber and NGCP
- **Reseller:** the entity who is the direct, administrative service provider of a group of customers and subscribers registered on NGCP; Sipwise C5 operator may also charge a reseller for the calls initiated or received by its subscribers
- **User:** the subscriber who either is registered on NGCP, or is an external call party

## 6.7.2. File Name Format

In order to be able to easily identify billing files, the file names are constructed by the following fixed-length fields:

```
<prefix><separator><version><separator><timestamp><separator><sequence number><suffix>
```

The definition of the specific fields is as follows:

Table 3. CDR/EDR export file name format

File name element	Length	Description
<prefix>	7	A fixed string. Always sipwise.
<separator>	1	A fixed character. Always _.
<version>	3	The format version, a three digit number. Currently 007.
<timestamp>	14	The file creation timestamp in the format YYYYMMDDhhmmss.
<sequence number>	10	A unique 10-digit zero-padded sequence number for quick identification.
<suffix>	4	A fixed string. Always .cdr or .edr.

A valid example filename for a CDR billing file created at 2012-03-10 14:30:00 and being the 42nd file exported by the system, is:

```
sipwise_007_20130310143000_0000000042.cdr
```

### 6.7.3. File Format

Each billing file consists of three parts: one header line, zero to 5000 body lines and one trailer line.

#### File Header Format

The billing file header is one single line, which is constructed by the following fields:

```
<version>,<number of records>
```

The definition of the specific fields is as follows:

Table 4. CDR/EDR export file header line format

Body Element	Length	Type	Description
<version>	3	zero-padded uint	The format version. Currently 007.
<number of records>	4	zero-padded uint	The number of body lines contained in the file.

A valid example for a Header is:

```
007,0738
```

#### File Body Format for Call Detail Records (CDR)

The body of a CDR consists of a minimum of zero and a default maximum of 5000 lines. The platform operator can configure the maximum number of lines kept in a file by updating the `cdrexport.max_rows_per_file` parameter in `/etc/ngcp-config/config.yml` file. Each line holds one call detail record in CSV format and is constructed by a configurable set of fields, all of them enclosed in single quotes.

The following table defines the **default set of fields** that are inserted into the CDR file, for exports related to `system` scope. The list of fields is defined in `/etc/ngcp-config/config.yml` file, `cdrexport.admin_export_fields` parameter.

Table 5. Default set of system CDR fields

Body Element	Length	Type	Description
CDR_ID	1-10	uint	Internal CDR ID.
UPDATE_TIME	19	timestamp	Timestamp of last modification, including date and time (with seconds precision).

Body Element	Length	Type	Description
SOURCE_USER_ID	36	string	Internal UUID of calling party subscriber. Value is 0 if calling party is external.
SOURCE_PROVIDER_ID	0-255	string	Internal ID of the contract of calling party provider (i.e. reseller or peer).
SOURCE_EXTERNAL_SUBSCRIBER_ID	0-255	string	External, arbitrary ID of calling party subscriber. (A string value shown as "External ID" property of an Sipwise C5 subscriber.)
SOURCE_SUBSCRIBER_ID	1-11	uint	Internal ID of calling party subscriber. Value is 0 if calling party is external.
SOURCE_EXTERNAL_CONTRACT_ID	0-255	string	External, arbitrary ID of calling party customer. (A string value shown as "External ID" property of an Sipwise C5 customer/peer.)
SOURCE_ACCOUNT_ID	1-11	uint	Internal ID of calling party customer.
SOURCE_USER	0-255	string	SIP username of calling party.
SOURCE_DOMAIN	0-255	string	SIP domain of calling party.
SOURCE_CLI	0-64	string	CLI of calling party in E.164 format.
SOURCE_CLIR	1	uint	1 for calls with CLIR, 0 otherwise.
SOURCE_IP	0-64	string	IP Address of the calling party.
DESTINATION_USER_ID	36	string	Internal UUID of called party subscriber. Value is 0 if called party is external.
DESTINATION_PROVIDER_ID	0-255	string	Internal ID of the contract of called party provider (i.e. reseller or peer).
DESTINATION_EXTERNAL_SUBSCRIBER_ID	0-255	string	External, arbitrary ID of called party subscriber. (A string value shown as "External ID" property of an Sipwise C5 subscriber.)
DESTINATION_SUBSCRIBER_ID	1-11	uint	Internal ID of called party subscriber. Value is 0 if calling party is external.
DESTINATION_EXTERNAL_CONTRACT_ID	0-255	string	External, arbitrary ID of called party customer. (A string value shown as "External ID" property of an Sipwise C5 customer/peer.)
DESTINATION_ACCOUNT_ID	1-11	uint	Internal ID of called party customer.

Body Element	Length	Type	Description
DESTINATION_USER	0-255	string	Final SIP username of called party.
DESTINATION_DOMAIN	0-255	string	Final SIP domain of called party.
DESTINATION_USER_IN	0-255	string	Incoming SIP username of called party, after applying inbound rewrite rules.
DESTINATION_DOMAIN_IN	0-255	string	Incoming SIP domain of called party, after applying inbound rewrite rules.
DESTINATION_USER_DIALED	0-255	string	The user-part of the SIP Request URI as received by NGCP.
PEER_AUTH_USER	0-255	string	Username used to authenticate towards peer.
PEER_AUTH_REALM	0-255	string	Realm used to authenticate towards peer.
CALL_TYPE	3-4	string	The type of the call - one of:  call: normal call  cfu: call forward unconditional  cfb: call forward busy  cft: call forward timeout  cfna: call forward not available  cfs: call forward for SMS  cfr: call forward on response  cfo: call forward on overflow

Body Element	Length	Type	Description
<b>CALL_STATUS</b>	2-8	string	The final call status - one of:  ok: successful call  busy: called party busy  noanswer: no answer from called party  cancel: cancel from caller  offline called party offline  timeout: no reply from called party  other: unspecified, see <b>CALL_CODE</b> field for details
<b>CALL_CODE</b>	3	string	The final SIP status code.
<b>INIT_TIME</b>	23	timestamp	Timestamp of call initiation (SIP 'INVITE' received from calling party). Includes date, time with milliseconds (3 decimals).
<b>START_TIME</b>	23	timestamp	Timestamp of call establishment (final SIP response received from called party). Includes date, time with milliseconds (3 decimals).
<b>DURATION</b>	4-13	fixed precision (3 decimals)	Length of call (calculated from <b>START_TIME</b> ) including milliseconds (3 decimals).
<b>END_TIME</b>	23	timestamp	<b>START_TIME</b> plus <b>DURATION</b> .
<b>INIT_TIME_TRUNCATED</b>	19	timestamp	<b>INIT_TIME</b> without milliseconds.
<b>START_TIME_TRUNCATED</b>	19	timestamp	<b>START_TIME</b> without milliseconds.
<b>END_TIME_TRUNCATED</b>	19	timestamp	<b>END_TIME</b> without milliseconds.
<b>TIMEZONE</b>	100	string	The name of the local subscriber's active timezone, defined by the contact of the subscriber/contract/reseller. The caller's timezone is used for outgoing calls. For calls from external subscribers, the callee's timezone is used. System timezone (defined in config.yml) is used for transit calls.

Body Element	Length	Type	Description
INIT_TIME_LOCALIZED	23	timestamp	INIT_TIME, converted to TIMEZONE.
START_TIME_LOCALIZED	23	timestamp	START_TIME, converted to TIMEZONE.
END_TIME_LOCALIZED	23	timestamp	END_TIME, converted to TIMEZONE.
INIT_TIME_LOCALIZED_TRUNCATED	19	timestamp	INIT_TIME_LOCALIZED without milliseconds.
START_TIME_LOCALIZED_TRUNCATED	19	timestamp	START_TIME_LOCALIZED without milliseconds.
END_TIME_LOCALIZED_TRUNCATED	19	timestamp	END_TIME_LOCALIZED without milliseconds.
CALL_ID	0-255	string	The SIP Call-ID.
RATING_STATUS	2-7	string	The internal rating status of the CDR - one of:  unrated: not rated  ok: successfully rated  failed: error while rating  Currently always ok or unrated, depending on whether rating is enabled or not.
RATED_AT	0-19	datetime	Time of rating, including date and time (with seconds precision). Empty if CDR is not rated.
SOURCE_CARRIER_COST	7-14	fixed precision (6 decimals)	The originating carrier cost that the carrier (i.e. SIP peer) charges for the calls routed to his network, or empty if CDR is not rated.  <i>PLEASE NOTE: Only available in system exports, not for resellers.</i>
SOURCE_CUSTOMER_COST	7-14	fixed precision (6 decimals)	The originating customer cost, or empty if CDR is not rated.

Body Element	Length	Type	Description
SOURCE_CARRIER_ZONE	0-127	string	Name of the originating carrier billing zone, or <b>onnet</b> if data is not available.  <i>PLEASE NOTE: Only available in system exports, not for resellers.</i>
SOURCE_CUSTOMER_ZONE	0-127	string	Name of the originating customer billing zone, or empty if CDR is not rated.
SOURCE_CARRIER_DETAIL	0-127	string	Description of the originating carrier billing zone, or <b>platform internal</b> if data is not available.  <i>PLEASE NOTE: Only available in system exports, not for resellers.</i>
SOURCE_CUSTOMER_DETAIL	0-127	string	Description of the originating customer billing zone, or empty if CDR is not rated.
SOURCE_CARRIER_FREE_TIME	1-10	uint	The number of free time seconds used on originating carrier side, or empty if CDR is not rated.  <i>PLEASE NOTE: Only available in system exports, not for resellers.</i>
SOURCE_CUSTOMER_FREE_TIME	1-10	uint	The number of free time seconds used from the originating customer's account balance, or empty if CDR is not rated.
DESTINATION_CARRIER_COST	7-14	fixed precision (6 decimals)	The terminating carrier cost, or empty if CDR is not rated.  <i>PLEASE NOTE: Only available in system exports, not for resellers.</i>
DESTINATION_CUSTOMER_COST	7-14	fixed precision (6 decimals)	The terminating customer cost, or empty if CDR is not rated.
DESTINATION_CARRIER_ZONE	0-127	string	Name of the terminating carrier billing zone, or <b>onnet</b> if data is not available.  <i>PLEASE NOTE: Only available in system exports, not for resellers.</i>

Body Element	Length	Type	Description
DESTINATION_CUSTOMER_ZONE	0-127	string	Name of the terminating customer billing zone, or empty if CDR is not rated.
DESTINATION_CARRIER_DETAIL	0-127	string	Description of the terminating carrier billing zone, or empty if CDR is not rated.  <i>PLEASE NOTE: Only available in system exports, not for resellers.</i>
DESTINATION_CUSTOMER_DETAIL	0-127	string	Description of the terminating customer billing zone, or empty if CDR is not rated.
DESTINATION_CARRIER_FREE_TIME	1-10	uint	The number of free time seconds used on terminating carrier side, or empty if CDR is not rated.  <i>PLEASE NOTE: Only available in system exports, not for resellers.</i>
DESTINATION_CUSTOMER_FREE_TIME	1-10	uint	The number of free time seconds used from the terminating customer's account balance, or empty if CDR is not rated.
SOURCE_RESELLER_COST	7-14	fixed precision (6 decimals)	The originating reseller cost, or empty if CDR is not rated.  <i>PLEASE NOTE: Only available in system exports, not for resellers.</i>
SOURCE_RESELLER_ZONE	0-127	string	Name of the originating reseller billing zone, or empty if CDR is not rated.  <i>PLEASE NOTE: Only available in system exports, not for resellers.</i>
SOURCE_RESELLER_DETAIL	0-127	string	Description of the originating reseller billing zone, or empty if CDR is not rated.  <i>PLEASE NOTE: Only available in system exports, not for resellers.</i>

Body Element	Length	Type	Description
SOURCE_RESELLER_FREE_TIME	1-10	uint	The number of free time seconds used from the originating reseller's account balance, or empty if CDR is not rated.  <i>PLEASE NOTE: Only available in system exports, not for resellers.</i>
DESTINATION_RESELLER_COST	7-14	fixed precision (6 decimals)	The terminating reseller cost, or empty if CDR is not rated.  <i>PLEASE NOTE: Only available in system exports, not for resellers.</i>
DESTINATION_RESELLER_ZONE	0-127	string	Name of the terminating reseller billing zone, or empty if CDR is not rated.  <i>PLEASE NOTE: Only available in system exports, not for resellers.</i>
DESTINATION_RESELLER_DETAIL	0-127	string	Description of the terminating reseller billing zone, or empty if CDR is not rated.  <i>PLEASE NOTE: Only available in system exports, not for resellers.</i>
DESTINATION_RESELLER_FREE_TIME	1-10	uint	The number of free time seconds used from the terminating reseller's account balance, or empty if CDR is not rated.  <i>PLEASE NOTE: Only available in system exports, not for resellers.</i>
<line_terminator>	1	string	Always \n (special char LF - ASCII 0x0A).

A valid example of one body line of a rated CDR is (line breaks added for clarity):

```
'15','2013-03-26 22:09:11','a84508a8-d256-4c80-a84e-820099a827b0','1','','1','','2','testuser1','192.168.51.133','4311001','0','192.168.51.1','94d85b63-8f4b-43f0-b3b0-221c9e3373f2','1','','3','','4','testuser3','192.168.51.133','testuser3','192.168.51.133','testuser3','','','call','ok','200','2013-03-25 20:24:50.890','2013-03-25 20:24:51.460','10.880','44449842','ok','2013-03-25 20:25:27','0.00','24.00','onnet','testzone','platform internal','testzone','0','0','0.00','200.00','','foo','','foo','0','0',
```

```
'0.00', '', '', '0', '0.00', '', '', '0'
```

The format of the **CDR export files generated for resellers** (as opposed to the complete system-wide export) is identical except for a few missing fields.

**NOTE**

Please check the description of fields in the table above, in order to see which fields are omitted for *reseller* related CDR exports.

The list of fields for *reseller* CDR export is defined in `/etc/ngcp-config/config.yml` file, `cdrexport.reseller_export_fields` parameter.

Multiple independent export configurations can be declared in `config.yml`, representing a separate CDR *stream* each.

```
cdrexport:
  my_stream1:
    admin_export_fields:
    ...
  other_stream2:
    admin_export_fields:
    ...
  ...
```

The streams will be processed *one after the other* by the exporter job.

## Extra fields that can be exported to CDRs

### Supplementary Data

There are fields in CDR database that contain **supplementary data** related to subscribers. This data is not used by Sipwise C5 for CDR processing but rather provides the system administrator with a possibility to include supplementary information in CDRs.

**NOTE**

*This informational section is meant for problem solving / debugging purpose:* The supplementary data listed in following table is stored in `provisioning.voip_preferences` database table.

Table 6. Supplementary data in CDR fields

Body Element	Length	Type	Description
<code>SOURCE_GPP0</code>	0-255	string	Supplementary data field 0 of calling party.
<code>SOURCE_GPP1</code>	0-255	string	Supplementary data field 1 of calling party.
<code>SOURCE_GPP2</code>	0-255	string	Supplementary data field 2 of calling party.
<code>SOURCE_GPP3</code>	0-255	string	Supplementary data field 3 of calling party.
<code>SOURCE_GPP4</code>	0-255	string	Supplementary data field 4 of calling party.
<code>SOURCE_GPP5</code>	0-255	string	Supplementary data field 5 of calling party.

Body Element	Length	Type	Description
SOURCE_GPP6	0-255	string	Supplementary data field 6 of calling party.
SOURCE_GPP7	0-255	string	Supplementary data field 7 of calling party.
SOURCE_GPP8	0-255	string	Supplementary data field 8 of calling party.
SOURCE_GPP9	0-255	string	Supplementary data field 9 of calling party.
DESTINATION_GPP0	0-255	string	Supplementary data field 0 of called party.
DESTINATION_GPP1	0-255	string	Supplementary data field 1 of called party.
DESTINATION_GPP2	0-255	string	Supplementary data field 2 of called party.
DESTINATION_GPP3	0-255	string	Supplementary data field 3 of called party.
DESTINATION_GPP4	0-255	string	Supplementary data field 4 of called party.
DESTINATION_GPP5	0-255	string	Supplementary data field 5 of called party.
DESTINATION_GPP6	0-255	string	Supplementary data field 6 of called party.
DESTINATION_GPP7	0-255	string	Supplementary data field 7 of called party.
DESTINATION_GPP8	0-255	string	Supplementary data field 8 of called party.
DESTINATION_GPP9	0-255	string	Supplementary data field 9 of called party.

### Account balance details (prepaid calls)

There are fields in CDR database that show **changes in cash or free time balance**. In addition to that, a history of billing packages / profiles may also be present, since Sipwise C5 vouchers, that are used to top-up, may also be set up to cause a transition of profile packages. (Which in turn can result in changing the billing profile/applicable fees). Therefore the billing package and profile valid at the time of the CDR are recorded and exposed as fields for CDR export.

**TIP** Such fields may also be required to integrate Sipwise C5 with legacy billing systems.

**NOTE** Please be aware that pre-paid billing functionality is only available in *Sipwise C5 PRO* and *Sipwise C5 CARRIER* products.

The name of CDR data field consists of the elements listed below:

1. source|destination: decides if the data refers to calling (source) or called (destination) party
2. carrier|reseller|customer: the account owner, whose billing data is referred
3. data type:
  1. cash\_balance|free\_time\_balance \_ before|after: cash balance or free time balance, before or after the call
  2. profile\_package\_id|contract\_balance\_id: internal ID of the active pre-paid billing profile or the account balance

Examples:

- source\_customer\_cash\_balance\_before
- destination\_customer\_profile\_package\_id

**IMPORTANT**

For calls spanning multiple balance intervals, the latter one will be selected, that is the balance interval where the call ended.

**IMPORTANT**

There are some limitations in rating **pre-paid** calls, please visit [Pre-paid Billing](#) section for details.

**Transformation of Values**

Each field allows to define a *perl* function to *transform* the values obtained from the database records. This can e.g. be used to manipulate numbers, as shown in the example below.

```
cdrexport:
  my_stream1:
    admin_export_fields:
      ...
      - name: header_Diversion
        enable: yes
        # Example: transform the subscriber number provided by the
        Diversion header
        transformation: "sub {

my ($value,$context) = @_;
my ($stmt,$sth);

my $number = $value;
my $cdr_id = $context->{out}->[1];

unless ($number) {
  unless ($context->{cdr}) {
    $stmt = 'select * from accounting.cdr where id = ?';
    $sth = $context->{dbh}->prepare($stmt);
    $sth->execute($cdr_id) or die 'failed to load cdr';
    $context->{cdr} = $sth->fetchrow_hashref();
    die 'failed to load cdr' unless $context->{cdr};
    $sth->finish();
  }
}

$number = $context->{cdr}->{source_cli} unless $number;
$number = $context->{cdr}->{source_user} unless $number;

if ($number =~ /^\\+?43/) {
  $number =~ s/^\\+?43/00/;
} elsif ($number =~ /^[1-9]/) {
  $number = '0' . $number;
}

return $number;

}"
  ...
```

## Distinguish between on-net and off-net calls CDRs

On-net calls (made only between devices on your network) are sometimes treated differently from off-net calls (terminated to or received from a peer) in external billing systems.

To distinguish between on-net and off-net calls in such a billing systems, check the **source\_user\_id** and **destination\_user\_id** fields. For on-net calls, both fields will have a different from zero value (actually, a UUID).

## File Body Format for Event Detail Records (EDR)

The body of an EDR consists of a minimum of zero and a maximum of 5000 lines. The platform operator can configure the maximum number of lines kept in a file by updating the `eventexport.max_rows_per_file` parameter in `/etc/ngcp-config/config.yml` file. Each line holds one call detail record in CSV format and is constructed by the fields as per the subsequent table.

The following table defines the **default set of fields** that are inserted into the EDR file, for exports related to `system` scope. The list of fields is defined in `/etc/ngcp-config/config.yml` file, `eventexport.admin_export_fields` parameter.

Table 7. Default set of system EDR fields

Body Element	Length	Type	Description
<b>EVENT_ID</b>	1-11	uint	Internal EDR ID.
<b>TYPE</b>	0-255	string	The type of the event - one of:  start_profile: A subscriber profile has been newly assigned to a subscriber.  end_profile: A subscriber profile has been removed from a subscriber.  update_profile: A subscriber profile has been changed for a subscriber.  start_huntgroup: A subscriber has been provisioned as PBX / hunting group.  end_huntgroup: A subscriber has been deprovisioned as PBX / hunting group.  start_ivr: A subscriber has a new call-forward to Auto-Attendant.  end_ivr: A subscriber has removed a call-forward to Auto-Attendant.
<b>CONTRACT_EXTERNAL_ID</b>	0-255	string	The external ID of the customer. (A string value shown as "External ID" property of an Sipwise C5 customer.)

Body Element	Length	Type	Description
COMPANY	0-127	string	The company name of the customer's contact.
SUBSCRIBER_EXTERNAL_ID	0-255	string	The external ID of the subscriber. (A string value shown as "External ID" property of an Sipwise C5 subscriber.)  <i>PLEASE NOTE: This field is empty in case of <b>start_huntgroup</b> and <b>end_huntgroup</b> events.</i>
PRIMARY_NUMBER	0-64	string	The VoIP number of the subscriber with the highest ID (DID or primary number).
OLD_PROFILE_NAME	0-255	string	The old status of the event. Depending on the event_type:  start_profile: Empty.  end_profile: The name of the subscriber profile which got removed from the subscriber.  update_profile: The name of the former subscriber profile which got updated.  start_huntgroup: Empty.  end_huntgroup: Empty.  start_ivr: Empty.  end_ivr: Empty.
NEW_PROFILE_NAME	0-255	string	The new status of the event. Depending on the event_type:  start_profile: The name of the subscriber profile which got assigned to the subscriber.  end_profile: Empty.  update_profile: The name of the new subscriber profile which got applied.  start_huntgroup: Empty.  end_huntgroup: Empty.  start_ivr: Empty.  end_ivr: Empty.
TIMESTAMP	23	timestamp	Timestamp of event. Includes date, time with milliseconds (3 decimals).

Body Element	Length	Type	Description
RESELLER_ID	1-11	uint	Internal ID of the reseller which the event belongs to.  <i>PLEASE NOTE: Only available in system exports, not for resellers.</i>
<line_terminator>	1	string	A fixed character. Always \n (special char LF - ASCII 0x0A).

A valid example of one body line of an EDR is (line breaks added for clarity):

```
"1","start_profile","sipwise_ext_customer_id_4","Sipwise GmbH",
"sipwise_ext_subscriber_id_44","436667778","","1","2014-06-19
11:34:31","1"
```

The format of the **EDR export files generated for resellers** (as opposed to the complete system-wide export) is identical except for a few missing fields.

#### NOTE

Please check the description of fields in the table above, in order to see which fields are omitted for *reseller* related EDR exports.

The list of fields for *reseller* EDR export is defined in `/etc/ngcp-config/config.yml` file, `eventexport.reseller_export_fields` parameter.

#### Extra fields that can be exported to EDRs

There are fields in EDR database that contain **supplementary data** related to subscribers, for example subscriber phone numbers are such data.

Table 8. Supplementary data in EDR fields

Body Element	Length	Type	Description
SUBSCRIBER_PROFILE_SET_NAME	0-255	string	The subscriber's profile set name.
PILOT_SUBSCRIBER_PROFILE_SET_NAME	0-255	string	The profile set name of the subscriber's pilot subscriber.
PILOT_SUBSCRIBER_PROFILE_NAME	0-255	string	The profile name of the subscriber's pilot subscriber.
FIRST_NON_PRIMARY_ALIAS_USERNAME_BEFORE	0-255	string	The subscriber's non-primary alias with lowest ID, before number updates during the operation.
FIRST_NON_PRIMARY_ALIAS_USERNAME_AFTER	0-255	string	The subscriber's non-primary alias with lowest ID, after number updates during the operation.
PILOT_FIRST_NON_PRIMARY_ALIAS_USERNAME_BEFORE	0-255	string	The non-primary alias with lowest ID of the subscriber's pilot subscriber, before number updates during the operation.

Body Element	Length	Type	Description
PILOT_FIRST_NON_PRIMARY_ALIAS_USERNAME_AFTER	0-255	string	The non-primary alias with lowest ID of the subscriber's pilot subscriber, after number updates during the operation.
NON_PRIMARY_ALIAS_USERNAME	0-255	string	The non-primary alias of a subscriber affected by an <code>update_profile</code> , <code>start_profile</code> or <code>end_profile</code> event to track number changes.
PRIMARY_ALIAS_USERNAME_BEFORE	0-255	string	The subscriber's primary alias, before number updates during the operation.
PRIMARY_ALIAS_USERNAME_AFTER	0-255	string	The subscriber's primary alias, after number updates during the operation.
PILOT_PRIMARY_ALIAS_USERNAME_BEFORE	0-255	string	The primary alias of the subscriber's pilot subscriber, before number updates during the operation.
PILOT_PRIMARY_ALIAS_USERNAME_AFTER	0-255	string	The primary alias of the subscriber's pilot subscriber, after number updates during the operation.
FIRST_NON_PRIMARY_ALIAS_USERNAME_BEFORE_AFTER	0-255	string	Equals <code>FIRST_NON_PRIMARY_ALIAS_USERNAME_BEFORE</code> , if the value is not NULL, otherwise it's the same as <code>FIRST_NON_PRIMARY_ALIAS_USERNAME_AFTER</code> .
PILOT_FIRST_NON_PRIMARY_ALIAS_USERNAME_BEFORE_AFTER	0-255	string	Equals <code>PILOT_FIRST_NON_PRIMARY_ALIAS_USERNAME_BEFORE</code> , if the value is not NULL, otherwise it's the same as <code>PILOT_FIRST_NON_PRIMARY_ALIAS_USERNAME_AFTER</code> .

### File Trailer Format

The billing file trailer is one single line, which is constructed by the following fields:

```
<md5 sum>
```

The `<md5 sum>` is a 32 character hexadecimal MD5 hash of the *Header* and *Body*.

To validate the billing file, one must remove the Trailer before computing the MD5 sum of the file. The `ngcp-cdr-md5` program included in the `ngcp-cdr-exporter` package can be used to validate the integrity of the file.

Given a CDR-file named as `sipwise_001_20071110123000_0000000004.cdr`, the output of the integrity check for an intact CDR file would be:

```
$ ngcp-cdr-md5 sipwise_001_20071110123000_0000000004.cdr
/tmp/ngcp-cdr-md5.sipwise_001_20071110123000_0000000004.cdr.oqkd4P2zXI:
```

```
OK
```

If the file has been altered during transmission, the output of the integrity check would be:

```
$ ngcp-cdr-md5 sipwise_001_20071110123000_0000000004.cdr
/tmp/ngcp-cdr-md5.sipwise_001_20071110123000_0000000004.cdr.hUtuhKEn1:
FAILED
md5sum: WARNING: 1 of 1 computed checksum did NOT match
```

#### 6.7.4. File Transfer

Billing files are created twice per hour at minutes 25 and 55 and are stored in the home directory of the `cdrexport` user. If the amount of records within the transmission interval exceeds the threshold of 5000 records per file, multiple billing files are created. If no billing records are found for an interval, a billing file without body data is constructed for detection of lost billing files on the 3rd party side.

CDR and EDR files are fetched by a 3rd party billing system using SFTP or SCP with either public key or password authentication using the username `cdrexport`.

If public key authentication is chosen, the public key file has to be stored in the file `.ssh/authorized_keys` below the home directory of the `cdrexport` user (i.e. `/home/jail/home/cdrexport/.ssh/authorized_keys`). Otherwise, a password has to be set for the user.

The 3rd party billing system is responsible for deleting CDR files after fetching them.

**NOTE** The `cdrexport` user is kept in a jailed environment on the system, so it has only access to a very limited set of command-line utilities.

## 6.8. Billing Data Replication to Remote Databases

NGCP PRO/Carrier provide the `ngcp-cdr-exporter` system service that replicates CDR data to one or more remote Databases in *real-time*:

- PostgreSQL
- Microsoft SQL
- MySQL/MariaDB
- Oracle Database
- SQLite

It uses a 2PC (2-Phase-Commit) approach when transferring CDR data from the `accounting.cdr` table (source) to the target table (remote), known from wire transfer transactions. This ensures that records cannot get duplicated or lost during the transfer process, no matter if suspended, interrupted or restarted etc.

Each export configuration in the `cdr_exporter` section in `config.yml` represents an independent CDR *stream*:

```

bulk_processor:
  cdr_exporter:
    enable: yes
    streams:
      my_stream1:
        type: postgresql
        ...
      other_stream2:
        type: oracle
        ...
      new_stream3:
        type: mssql
        ...
      stream4:
        type: postgres
        enabled: false
        ...
    ...
  ...

```

Each stream is processed by the service *simultaneously*, to keep the latency minimal.

There is no distinction between reseller/system data; it supports more flexible filtering and transforming mechanisms instead.

### 6.8.1. Replication Pipeline

The processing follows a map-reduce scheme based on the *bulk-processor* ETL framework. It is a pipeline that builds and processes CDR object graphs. Each stage can be configured in detail:

1. fetch source CDR to export
2. populate the CDR object by fetching related data
3. expand (split) the CDR object
4. reduce (skip) CDR objects
5. map CDR object fields to output table columns

#### Stage 1: Fetch Source CDR

An optimized SQL query is generated that defines what records from the `accounting.cdr` table to consider for the replication. `export_conditions` represent a list of conjunction terms that are required to match in order to include a record. Each term is specified by:

- `column`: SQL table column name
- `operand`: comparison operator
- `compare_value`: rhs value

Tables of related records referenced in the conditions may require to specify an `export_join` which is made up of:

- **alias**: SQL join alias
- **key\_column**: table 1 column name
- **reference\_column**: table 2 column name

```
bulk_processor:
  cdr_exporterd:
    enable: yes
    streams:
      my_stream1:
        ...
        export_join_alias: cdrtable
        export_joins:
          - table: accounting.cdr
            alias: x
            key_column: cdrtable.id
            reference_column: x.id
        export_conditions:
          - column: x.update_time
            operator: >
            value: '2025-06-25 00:00:00'
        ...
```

## Stage 2: Populate Relations of the CDR Object

The CDR's related data such as source/destination subscriber or contract records form a *tree* structure. Each relation is addressed by a path notation, which uses the `.` symbol to denote the tree depth, e.g. `cdr.source_user.provisioning_voip_subscriber`. Available relations to choose from are hard-wired, with data sources not limited to just related records from NGCP MariaDB tables:

- Redis records, ie. subscriber location data
- REST-APIs (NGCP or remote services)
- Data from message queues (Kafka, Redis PubSub, ...)

A relation in the **relations** list will be loaded from the data source when enabled. It can be conditionally skipped or transformed if needed:

- **load**: *Javascript* or *perl* function to define whether to load the relation value (tree)
- **filter**: *Javascript* or *perl* function to filter collection values
- **transform**: *Javascript* or *perl* function to modify the relation value (tree)

All relations with data required in the output table have to be retrieved, but to minimize load and latency it is recommended to disable those that are not needed. Below example gives an overview of relations available for the CDR object scheme:

```
bulk_processor:
  cdr_exporterd:
    enable: yes
    streams:
      my_stream1:
```

```

...
relations:
  cdr.source_user:
    load: !!perl/code |
      {
        my ($cdr) = @_;
        info("this function should return 1 to load the cdr.source_user graph");
        #return 0 if $cdr->{source_user_id} eq '0';
        return 1;
      }
  cdr.source_user.domain: 1
  cdr.source_user.primary_number: 1
  cdr.source_user.provisioning_voip_subscriber: 1
  cdr.source_user.provisioning_voip_subscriber.voip_dbaliases: 1
  cdr.source_user.provisioning_voip_subscriber.voip_usr_preferences: 1
  cdr.source_user.provisioning_voip_subscriber.voip_usr_preferences.attribute: 1
  cdr.source_user.provisioning_voip_subscriber.voip_usr_preferences.allowed_ips: 1
  cdr.source_user.provisioning_voip_subscriber.voip_usr_preferences.ncos: 1
  cdr.source_user.provisioning_voip_subscriber.voip_usr_preferences.cf_mapping: 1
  cdr.source_user.provisioning_voip_subscriber.voip_usr_preferences.cf_mapping.destinations:
1
  cdr.source_user.provisioning_voip_subscriber.voicemail_users: 1
  #cdr.source_user.provisioning_voip_subscriber.voicemail_users.voicemail_spool: 1
  cdr.source_user.provisioning_voip_subscriber.voip_fax_preferences: 1
  cdr.source_user.provisioning_voip_subscriber.voip_fax_destinations:
    transform: !!perl/code |
      {
        my ($fax_destinations,$prov_subscriber) = @_;
        info("this function converts each fax_destination record to a string");
        return [
          map { $_->{destination} . ' (' . $_->{filetype} . ')'; } @$fax_destinations
        ];
      }
  cdr.source_user.provisioning_voip_subscriber.profile: 1
  cdr.source_user.provisioning_voip_subscriber.voip_domain: 1
  cdr.source_user.provisioning_voip_subscriber.registrations: 1
  cdr.source_user.provisioning_voip_subscriber.registrations._entries: 1
  cdr.source_provider: 1
  cdr.source_provider.contact: 1
  cdr.source_provider.voip_peer_groups: 1
  cdr.source_provider.resellers: 1
  cdr.source_account: 1
  cdr.source_account.product: 1
  cdr.source_account.voip_subscribers:
    filter: |
      function(billSubscriber, sourceAccount) {
        if (billSubscriber.status == 'terminated') {
          debug("skipping terminated source_account subscriber " + billSubscriber.username);
          return 0;
        }
        return 1;
      }
  cdr.source_provider.contact: 1
  #cdr.source_provider.voip_peer_groups: 0
  #cdr.source_provider.resellers: 0
  cdr.destination_user: 1
  cdr.destination_provider: 1
  cdr.destination_account: 1
  cdr.source_carrier_billing_fee: 1
  cdr.source_reseller_billing_fee: 1
  cdr.source_customer_billing_fee: 1
  cdr.source_carrier_billing_zone: 1
  cdr.source_reseller_billing_zone: 1
  cdr.source_customer_billing_zone: 1
  cdr.destination_carrier_billing_fee: 1
  cdr.destination_reseller_billing_fee: 1
  cdr.destination_customer_billing_fee: 1
  cdr.destination_carrier_billing_zone: 1

```

```

cdr.destination_reseller_billing_zone: 1
cdr.destination_customer_billing_zone: 1
cdr.cdr_groups: 1
cdr.cdr_groups.cdrcs: 1
cdr.cdr_groups.cdrcs.source_user: 1
cdr.cdr_tags: 1
cdr.cdr_tags.tag: 1
cdr.cdr_tags.provider: 1
cdr.cdr_tags.direction: 1
cdr.cdr_mos: 1
cdr.cdr_status: 1
cdr.cdr_status.status: 1
cdr.cdr_relations: 1
cdr.cdr_relations.relation: 1
cdr.cdr_relations.provider: 1
cdr.cdr_relations.direction: 1
cdr.cdr_presentity: 1
cdr.cdr_cash_balances: 1
cdr.cdr_cash_balances.contract_balance: 1
cdr.cdr_cash_balances.provider: 1
cdr.cdr_cash_balances.direction: 1
cdr.cdr_time_balances.contract_balance: 1
cdr.cdr_time_balances.provider: 1
cdr.cdr_time_balances.direction: 1
...
...

```

### Stage 3: Expand/Split the CDR Object

Complex exporter logic requirements can involve modifying the number of exported records, which can be implemented with the expand/reduce stages. E.g. when exporting CDRs of special call scenarios, it can be desired to produce 2 or more records from the originating CDR. This can be done with a function provided by the `expand_cdrcs` element.

```

bulk_processor:
  cdr_exporter:
    enable: yes
    streams:
      my_stream1:
        ...
        expand_cdrcs: !!perl/code |
          sub {
            my ($arg) = @_;
            if (stash_get('expandcdrcsDone')) { return; } else { stash_set('expandcdrcsDone',1); }
            my $test = { x => 'x', y => 'y' };
            stash_set('test',$test);
            if (to_json($test,0,1) eq to_json(stash_get('test'),0,1)) {
              info("stash test ok");
            } else {
              warn("stash test failed");
            }
            info("this is a perl snippet (coderef from yaml)");
            my ($x,$y) = (2, 3);
            info("$x . " + " . $y . " = " . ($x + $y));
            info("symbol table: " . join(',', get_env()));
            info("we are processing cdr id " . $cdr->{id});
            info("dump cdr variable: " . to_json($cdr,1));
            info("dump arg variable: " . to_json($arg));
            #info("dump cdrcs variable: " . to_json($cdrcs));
            #info("dump stream variable: " . to_json($stream));
            info("some db query result - cdr count = " .
              $db->db_get_value("select count(1) from accounting.cdr"));
          }

```

```

    return ($cdr,$cdr); #export every cdr twice ..
  }
  ...

```

The example above demonstrates general features of the scripting environment, including:

- stash for storing variables across iterations (`stash_set`, `stash_get`)
- logging (`info`, `warn`, ...)
- serialisation (`to_json`, ...)
- database queries (`db_get_value`, ...)
- context argument and variables (`$cdr/cdr`)

The same `expand_cdrs` function example using *Javascript* language:

```

bulk_processor:
  cdr_exporterd:
    enable: yes
    streams:
      my_stream1:
        ...
        expand_cdrs: |
          function(arg) {
            if (stash_get('expandcdrsDone')) { return; } else { stash_set('expandcdrsDone',true); }
            var test = { x: 'x', y: 'y' };
            stash_set('test',test);
            if (to_json(test,0,1) == to_json(stash_get('test'),0,1)) {
              info("stash test ok");
            } else {
              warn("stash test failed");
            }
            info("this is a javascript snippet (string)");
            var x = 2, y = 3;
            info(x + " + " + y + " = " + (x + y));
            info("symbol table: " + get_env());
            info("we are processing cdr id " + cdr.id);
            info("dump cdr variable: " + to_json(cdr,1));
            info("dump arg variable: " + to_json(arg));
            //info("dump cdrs variable: " + to_json(cdrs));
            //info("dump stream variable: " + to_json(stream));
            info("select count(1) from accounting.cdr: " +
              db_get_value("select count(1) from accounting.cdr"));
            return [ cdr, cdr ]; // e.g. export every cdr twice ..
          }
        ...

```

If omitted, the CDR object will be passed as-is by default, which is equivalent to the `expand_cdrs` function below:

```

bulk_processor:
  cdr_exporterd:
    enable: yes
    streams:
      my_stream1:
        ...
        expand_cdrs: |

```

```

    function(arg) {
        return cdr;
    }
    ...

```

#### Stage 4: Reduce/Skip CDR Objects

The reduce stage allows to skip creating records. This can be required to e.g. collapse CDRs from call legs or correlated CDRs (`cdr_group`) of special call scenarios. To skip exporting a CDR safely across batches and threads, the `export_status` needs to be set to a value other than `unexported`. This can be done with a function provided by the `cdrs_export_status` element. The example below is notional, it will skip every other pair of CDRs:

```

bulk_processor:
  cdr_exporterd:
    enable: yes
    streams:
      my_stream1:
        ...
        cdrs_export_status: |
          function(record) {
            return [[ record.id, "ok" ], [ record.id+2, "ok" ]];
          }
        ...

```

If omitted, the status of exported CDRs will be set to `ok` by default.

#### Stage 5: Map CDR Object to Output

The final stage defines which CDR tree elements to map to the output table. This projection can be configured with the `table_fields` list. Each element defines mapping parameters:

- **path**: path notation of the CDR tree element. An element of a collection value is denoted by the element index in `[]` brackets, e.g. `provisioning_voip_subscriber.voip_usr_preferences.cfu[0].cf_mapping.destinations[99].destination`
- **colname**: column name in the output table of the remote database
- **transform**: *Javascript* or *perl* function to convert the value (tree)
- **sep**: convert a collection value to string using the given separator
- **field**: convert objects in the collection value to string using the given object field

If the output table in the remote database is not present yet, it will be created automatically with columns of SQL `TEXT` data type. Below `table_fields` list presumes the relations loaded for the CDR object from the stage 2 example.

```

bulk_processor:
  cdr_exporterd:
    enable: yes
    streams:

```

```

my_stream1:
...
table_fields:
- path: rating_status
  colname: column1
  transform: !!perl/code |
    sub {
      my ($v) = @_;
      info("count " . $db->db_get_value("select count(1) from accounting.cdr"));
      #info($context,"test");
      use Data::Dumper;
      #info($context,Dumper($context));
      #info($context,join(",","keys %main:"));
      return uc($v); # convert to uppercase
    }
- path: update_time
  colname: column2
- path: id
  colname: column3
- path: contract.id
  transform: !!perl/code |
    {
      my ($id,$bill_subs) = @_;
      return $id; # pass through ...
    }
- path: primary_number.cc
- path: primary_number.ac
- path: primary_number.sn
- path: provisioning_voip_subscriber.voicemail_users[0].attach
- path: provisioning_voip_subscriber.voicemail_users[0].delete
- path: provisioning_voip_subscriber.voicemail_users[0].email
- path: provisioning_voip_subscriber.voicemail_users[0].password
- path: provisioning_voip_subscriber.voip_usr_preferences.allowed_clis
  sep: ','
  field: 'value'
- path: provisioning_voip_subscriber.voip_usr_preferences.allowed_ips_grp[0].allowed_ips
  sep: ','
  field: 'ipnet'
- path: provisioning_voip_subscriber.voip_usr_preferences.block_out_list
  sep: ','
  field: 'value'
- path: provisioning_voip_subscriber.voip_usr_preferences.block_out_mode[0].value
- path: provisioning_voip_subscriber.voip_usr_preferences.block_in_list
  sep: ','
  field: 'value'
- path: provisioning_voip_subscriber.voip_usr_preferences.block_in_mode[0].value
- path: provisioning_voip_subscriber.voip_usr_preferences.adm_block_in_list
  sep: ','
  field: 'value'
- path: provisioning_voip_subscriber.voip_usr_preferences.adm_block_in_mode[0].value
- path: provisioning_voip_subscriber.voip_usr_preferences.adm_block_out_list
  sep: ','
  field: 'value'
- path: provisioning_voip_subscriber.voip_usr_preferences.adm_block_out_mode[0].value
- path: provisioning_voip_subscriber.voip_usr_preferences.ncos_id[0].ncos.level
- path: provisioning_voip_subscriber.voip_usr_preferences.adm_ncos_id[0].ncos.level
- path: provisioning_voip_subscriber.voip_usr_preferences.cfb[0].cf_mapping.destinations
  sep: ','
  field: 'destination'
- path: provisioning_voip_subscriber.voip_usr_preferences.cfna[0].cf_mapping.destinations
  sep: ','
  field: 'destination'
- path: provisioning_voip_subscriber.voip_usr_preferences.cfo[0].cf_mapping.destinations
  sep: ','
  field: 'destination'
- path: provisioning_voip_subscriber.voip_usr_preferences.cfr[0].cf_mapping.destinations
  sep: ','
  field: 'destination'

```

```
- path: provisioning_voip_subscriber.voip_usr_preferences.cfs[0].cf_mapping.destinations
  sep: ','
  field: 'destination'
- path: provisioning_voip_subscriber.voip_usr_preferences.cft[0].cf_mapping.destinations
  sep: ','
  field: 'destination'
- path: provisioning_voip_subscriber.voip_usr_preferences.cfu[0].cf_mapping.destinations
  sep: ','
  field: 'destination'
- path: provisioning_voip_subscriber.voip_fax_preferences.active
- path: provisioning_voip_subscriber.voip_fax_preferences.ecm
- path: provisioning_voip_subscriber.voip_fax_preferences.name
- path: provisioning_voip_subscriber.voip_fax_preferences.t38
- path: provisioning_voip_subscriber.voip_fax_destinations
  sep: ','
- path:
provisioning_voip_subscriber.voip_usr_preferences.force_inbound_calls_to_peer[0].value
- path: provisioning_voip_subscriber.voip_usr_preferences.lnp_for_local_sub[0].value
...
...
```

# Chapter 7. Features

The Sipwise C5 provides plenty of subscriber features to offer compelling VoIP services to end customers, and also to cover as many deployment scenarios as possible. In this chapter, we provide the features overview and describe their function and use cases.

## 7.1. About the Admin Web Interface

This section is going to give some hints to the reader about the Admin web interface of Sipwise C5. The notes here are generic and apply to most of the features that we discuss in the handbook in subsequent chapters.

### 7.1.1. Filtering the Lists / Datatables

When you look at or want to change various settings on Admin web interface you will see datatables or lists of particular items, e.g. Subscribers, Peering Groups, etc. Sometimes this kind of list can be really long and then it's difficult to find the desired item there. To help the system administrator, the Sipwise C5 offers search filters for each of the lists / datatables. You have to type a search string (arbitrary text) in the *Search* textbox and the system will automatically filter the complete datatable for records that match the search string.

The screenshot shows the 'Subscribers' section of the Admin Web Interface. A search bar at the top right contains the text '200'. Below the search bar, a dropdown menu shows '10' entries. The main area contains a table with the following columns: Contract #, Contract #, Contact Email, Username, Domain, UUID, Status, Number, and Profile. The table displays 5 rows of data, with the 'Number' column values being 40333100200, 438882200102, 39555200, 44266200, and 438881200101. A status bar at the bottom left indicates 'Showing 1 to 5 of 5 entries (filtered from 49 total entries)'. A pagination control at the bottom right shows '1' in a highlighted box.

Contract #	Contract #	Contact Email	Username	Domain	UUID	Status	Number	Profile
39	3	tv@enterprise.org	ext200	1.c5.██████████.com	f25dcb6e-c56e-431a-9e7a-eada925f0de7	active	40333100200	
105	21	machsols4b_customer@example.org	machsols4b_subs2	██████████	afa78b9d-c02b-41de-9a77-d82006698e7a	active	438882200102	
121	27	basicsip@boghiclau	555200	c5.██████████.com	42e03f31-c068-46d8-9a58-0f2f9d938749	active	39555200	
159	19	cbs@tt.org	ext200	c5.██████████.com	86195f25-ab71-4aaa-85a8-caefb33b3fc0	active	44266200	
35	21	machsols4b_customer@example.org	machsols4b_subs101	s4b.c5.██████████.com	377394fe-2f67-4feb-8013-3fc35544807a	active	438881200101	

Figure 51. Filtered List of Subscribers

### The Search String

The previous example shows what happens if you type a search string in the *Search* textbox. The search string will be applied to all visible columns of the datatable as a filter and all matching records are kept displayed.

The **symbol can be used as \*wildcard** for zero-or-more characters.

#### NOTE

The **\*** is prepended and appended implicitly to the string entered in *Search* textbox to make filtering easier, for almost all datatables / lists.

While the search pattern is typically matched to values of all columns visible in the datatable, in some cases (i.e. unindexed columns) may be excluded from searching.

## 7.1.2. Call History

Each call appears in the subscriber's *Call History*, except globally suppressed ones (if suppressing is configured), and you can apply search filters to the table as in case of other datatables.

The *Call History* datatable behaves slightly differently when it comes to wildcard usage. The `*` wildcard needs to be entered explicitly by the user if needed.

Call List for machsols4b\_subs2@ (43 888 2200102)

← Back

Show all calls

Show 10 entries From Date: To Date: Search: s4b\_int\*

#	Caller	Callee	CLIR	Billing zone	Status	Start Time*	Duration	MOS avg	MOS packetloss	MOS jitter	MOS roundtrip	Call-ID	Cost
1505	438882200102	s4b_int432158@	0		cancel	2018-08-06 11:27:41.945	0:00:00					d54aec4a71e57db7c38db9e8cf894e1d	0.00
1507	438882200102	s4b_int31882200101@	0		noanswer	2018-08-06 11:28:10.273	0:00:00					d2f5a87577ee338fb326743fb2894e1d	0.00
1509	438882200102	s4b_int31882200101@	0	all	ok	2018-08-06 11:29:54.920	0:00:21.891	4.3	0.0	0.0	9999.0	13148ad1d3c16da8eba7dd5443894e1d	0.00
Total							0:00:21.891						0.00

Showing 1 to 3 of 3 entries (filtered from 10 total entries)

Figure 52. Filtered Call History

### CAUTION

Be aware that acceptable response times of the administrative web interface rely on utilizing available database indexes, which is impossible with a leading wildcard in the search string. Wildcards at the end of the search pattern do not impact performance.

## 7.2. Managing System Administrators

The Sipwise C5 offers the platform operator with an easy to use interface to manage users with administrative privileges. Such users are representatives of resellers, and are entitled to manage configuration of services for *Customers*, *Subscribers*, *Domains*, *Billing Profiles* and other entities on Sipwise C5.

Administrators, as user accounts, are also used for client authentication on the REST API of NGCP.

There are two administrators, whose account is enabled by default. Both of them belong to the *default reseller*. These users are the *superusers* of Sipwise C5 administrative web interface (the so-called "admin panel"), and they have the right to modify administrators of other *Resellers* as well. These users are:

- "administrator" is a default administrative account. It is fully manageable by the system owner.
- "sipwise" is solely for the Sipwise support access. This user can be only enabled or disabled but not

modified neither removed.

### 7.2.1. Configuring Administrators

Configuration of access rights of system administrators is possible through the admin panel of NGCP. In order to do that, please navigate to *Settings Administrators*.

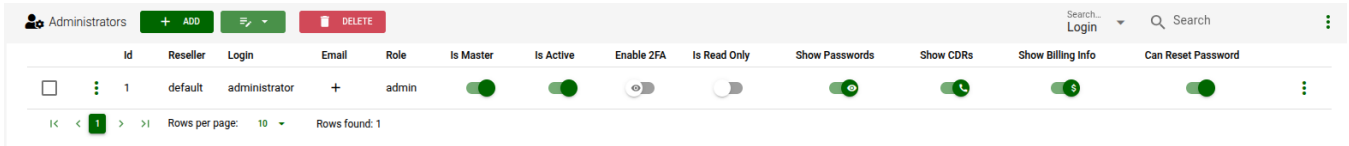

	Id	Reseller	Login	Email	Role	Is Master	Is Active	Enable 2FA	Is Read Only	Show Passwords	Show CDRs	Show Billing Info	Can Reset Password
<input type="checkbox"/>	1	default	administrator	+	admin	<input checked="" type="checkbox"/>	<input checked="" type="checkbox"/>	<input type="checkbox"/>	<input type="checkbox"/>	<input checked="" type="checkbox"/>	<input checked="" type="checkbox"/>	<input checked="" type="checkbox"/>	<input checked="" type="checkbox"/>

Figure 53. List of System Administrators

You have 2 options:

- If you'd like to **create** a new administrator user press *ADD* button.
- If you'd like to **edit** an existing administrator user press the three dots beside an existing administrator and then press the *Edit* button.

There are some generic attributes that have to be set for each administrator:

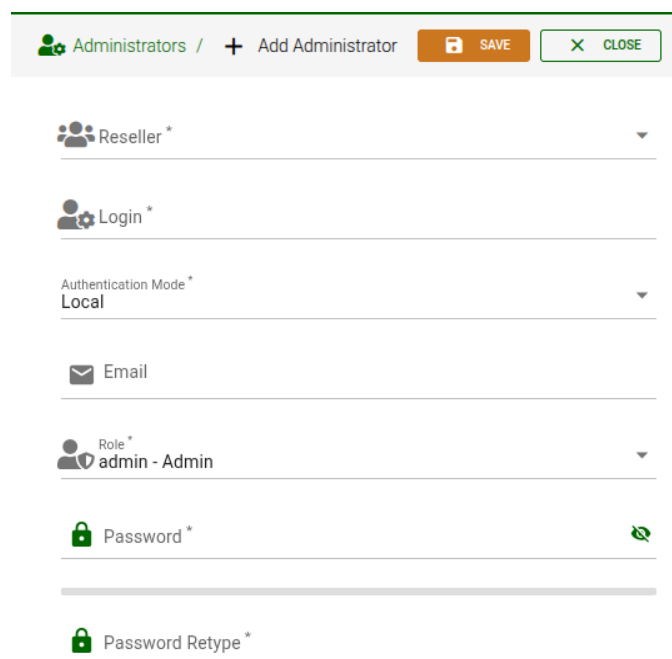

Administrators / + Add Administrator [SAVE] [CLOSE]

Reseller \*

Login \*

Authentication Mode \*  
Local

Email

Role \*  
admin - Admin

Password \*

Password Retype \*

Figure 54. Generic System Administrator Attributes

- *Reseller*: each administrator user must belong to a *Reseller*. There is always a default reseller (ID: **1**, Name: **default**), but the administrator has to be assigned to his real reseller, if such an entity (other than **default**) exists.
- *Login*: the login name of the administrator user
- *Password*: the password of the administrator user for logging in the admin panel, or for

authenticating REST API requests

- *Authentication Mode*: currently available options are:

local: Authenticate by matching login name and password stored in the local NGCP database

LDAP: Authenticate login name (converted to a cn) and provided password against a (remote) LDAP service

- *Email*: the email of the administrator user, used for resetting password.
- *Role*: role associated to the administrator user. The six available access roles are summarized in the next section of the handbook

#### NOTE

Due to the fact that administrators can request a password reset via email, no administrator is able to change a password or API key other than to himself. Administrators with `is_system`, `is_superuser` and `is_master` flags are the only ones that can change the username and email of other administrators, while the ones without those flags can only change their own email and password.

## 7.2.2. Administrator's Roles

Six different types of roles are available for administrators. The table below describes each of them and provides a correspondance with the old 'role flags'.

Table 9. System Administrator's Roles

Role	Old Access Right	Description
System	<code>Is system</code>	The user is allowed to create, delete or modify Lawful Intercept Admins which are otherwise invisible to other types of administrators.
Admin	<code>Is superuser</code>	The user is allowed to modify data on Reseller level and, if mixed with the "is_master" access right it is also able to modify administrators of other resellers. There should be only 1 user on Sipwise C5 with the combination of "admin" role and "is_master" privilege.
Reseller		The user is allowed to create, delete or modify Customers, Subscribers and any other element in the system only within a Reseller the user belongs to. It cannot create other administrator unless it has "is_master" access right.
Customer Care Admin	<code>Is ccare, Is superuser</code>	The user is allowed to create, delete or modify Customers and Subscribers across all Resellers. The user can access to relevant information required to create or modify Customers or Subscribers, such as Domains, Billing Profiles, Email Templates, but the user cannot access the entries (e.g: see the detailed info about a Billing Profile), nor modify them.

Role	Old Access Right	Description
Customer Care	Is ccare	The user is allowed to create, delete or modify Customers and Subscribers only within a Reseller the user belongs to. The user can access to relevant information required to create or modify Customers or Subscribers, such as Domains, Billing Profiles, Email Templates, but the user cannot access the entries (e.g: see the detailed info about a Billing Profile), nor modify them.
Lawful Intercept	Lawful intercept	Visible only for System administrators. It s the only role with access to the interceptions REST API (that is: /api/interceptions). Administrators with this flag do not have access to anything but the administrators in UI and API and /api/interceptions in the API.  NOTE: This means that besides enabling LI in config.yml configuration file one also needs to enable the API via the LI privilege of an administrator user, so that Sipwise C5 can really provide LI service.

### 7.2.3. Access Rights of Administrators

The various access rights of administrators are shown in the figure and summarized in the table below.

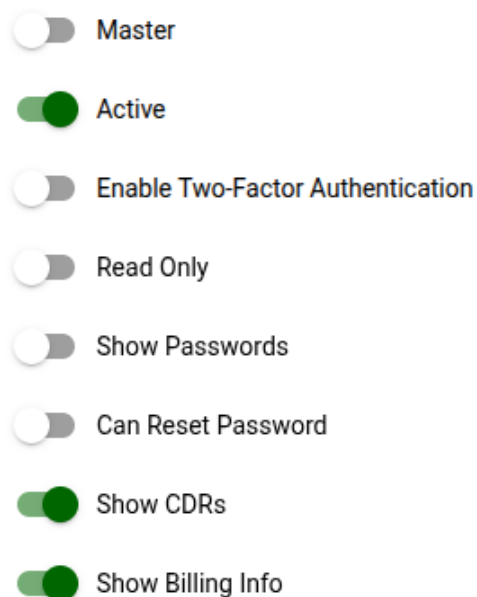

Figure 55. Access Rights of System Administrators

Table 10. Access Rights of System Administrators

Label in admin list	Access Right	Description
Master	<b>Is master</b>	The user is allowed to create, delete or modify other Admins who belong to the same Reseller.
Active	<b>Is active</b>	The user account is active, i.e. the admin user can login on the web panel or authenticate himself on REST API; otherwise user authentication will fail.
Enable Two-Factor Authentication	<b>Enable 2fa</b>	It enables mandatory 2FA for the administrator user.
Read Only	<b>Read only</b>	The user will only be able to list various data but is not allowed to modify anything.  * For the <b>web interface</b> this means that <i>Create...</i> and <i>Edit</i> buttons will be hidden or disabled. * For the <b>REST API</b> this means that only GET, HEAD, OPTIONS HTTP request methods are accepted, and Sipwise C5 will reject those targeting data modification: PUT, PATCH, POST, DELETE.
Show Passwords	<b>Show passwords</b>	The user sees subscriber passwords (in plain text) on the web interface.  NOTE: Admin panel user passwords and subscriber web passwords are stored in an unreadable way (cryptographic hash digest) in the database, while subscriber SIP passwords are stored in plain text. The latter happens on purpose, e.g. to make subscriber data migration possible.
Can Reset Password	<b>Can Reset Password</b>	The user is allowed to request a password reset.
Show CDRs	<b>Call data</b>	This privilege has effect on 2 items that will be displayed on admin panel of NGCP, when <i>Subscriber Details</i> is selected: 1. <i>PBX Groups</i> list, 2. <i>Captured Dialogs</i> list
Show Billing Info	<b>Billing data</b>	Some REST API resources that are related to billing are disabled: HTTP requests on <code>/api/vouchers</code> , <code>/api/topupcash</code> and <code>/api/topupvoucher</code> resources are rejected.

## 7.3. Access Control for SIP Calls

There are two different methods to provide fine-grained call admission control to both subscribers and admins. One is *Block Lists*, where you can define which numbers or patterns can be called from a subscriber to the outbound direction and which numbers or patterns are allowed to call a subscriber in the inbound direction. The other is *NCOS (Network Class of Service) Levels*, where the admin predefines rules for outbound calls, which are grouped in certain levels. The subscriber can then choose the level, or the admin can restrict a subscriber to a certain level. Also Sipwise C5 offers some options to restrict the IP addresses that subscriber is allowed to use the service from. The following sections describe these features in detail.

### 7.3.1. Block Lists

*Block Lists* provide a way to control which users/numbers can call or be called, based on a subscriber

level, and can be found in the *Call Blockings* section of the subscriber preferences.

Trusted Sources	
Call Blockings	
Name	Value
block_in_mode	<input type="checkbox"/>
block_in_list	
block_in_clir	<input type="checkbox"/>
block_out_mode	<input type="checkbox"/>
block_out_list	
adm_block_in_mode	<input type="checkbox"/>
adm_block_in_list	
adm_block_in_clir	<input type="checkbox"/>
adm_block_out_mode	<input type="checkbox"/>
adm_block_out_list	
ncos	

Block Lists are separated into *Administrative Block Lists* (*adm\_block\_\**) and *Subscriber Block Lists* (*block\_\**). They both have the same behaviour, but Administrative Block Lists take higher precedence. Administrative Block Lists are only accessible by the system administrator and can thus be used to override any Subscriber Block Lists, e.g. to block certain destinations. The following break-down of the various block features apply to both types of lists.

### Block Modes

Block lists can either be *whitelists* or *blacklists* and are controlled by the User Preferences *block\_in\_mode*, *block\_out\_mode* and their administrative counterparts.

- The *blacklist* mode (option is not checked) tells the system to **allow anything except the entries in the list**. Use this mode if you want to block certain numbers and allow all the rest.
- The *whitelist* mode indicates to **reject anything except the entries in the list**. Use this mode if you want to enforce a strict policy and allow only selected destinations or sources.

You can change a list mode from one to the other at any time.

### Block Lists

The list contents are controlled by the User Preferences *block\_in\_list*, *block\_out\_list* and their administrative counterparts. Click on the *Edit* button in the *Preferences* view to define the list entries.

In block list entries, you can provide shell patterns like *\** and *[]*. The behavior of the list is controlled by the *block\_xxx\_mode* feature (so they are either allowed or rejected). In our example above we have *block\_out\_mode* set to *blacklist*, so all calls to US numbers and to the Austrian number +431234567 are

going to be rejected.

In the call forward scenario both the original caller number as well as the forwarder number are checked against the *block\_in\_list*.

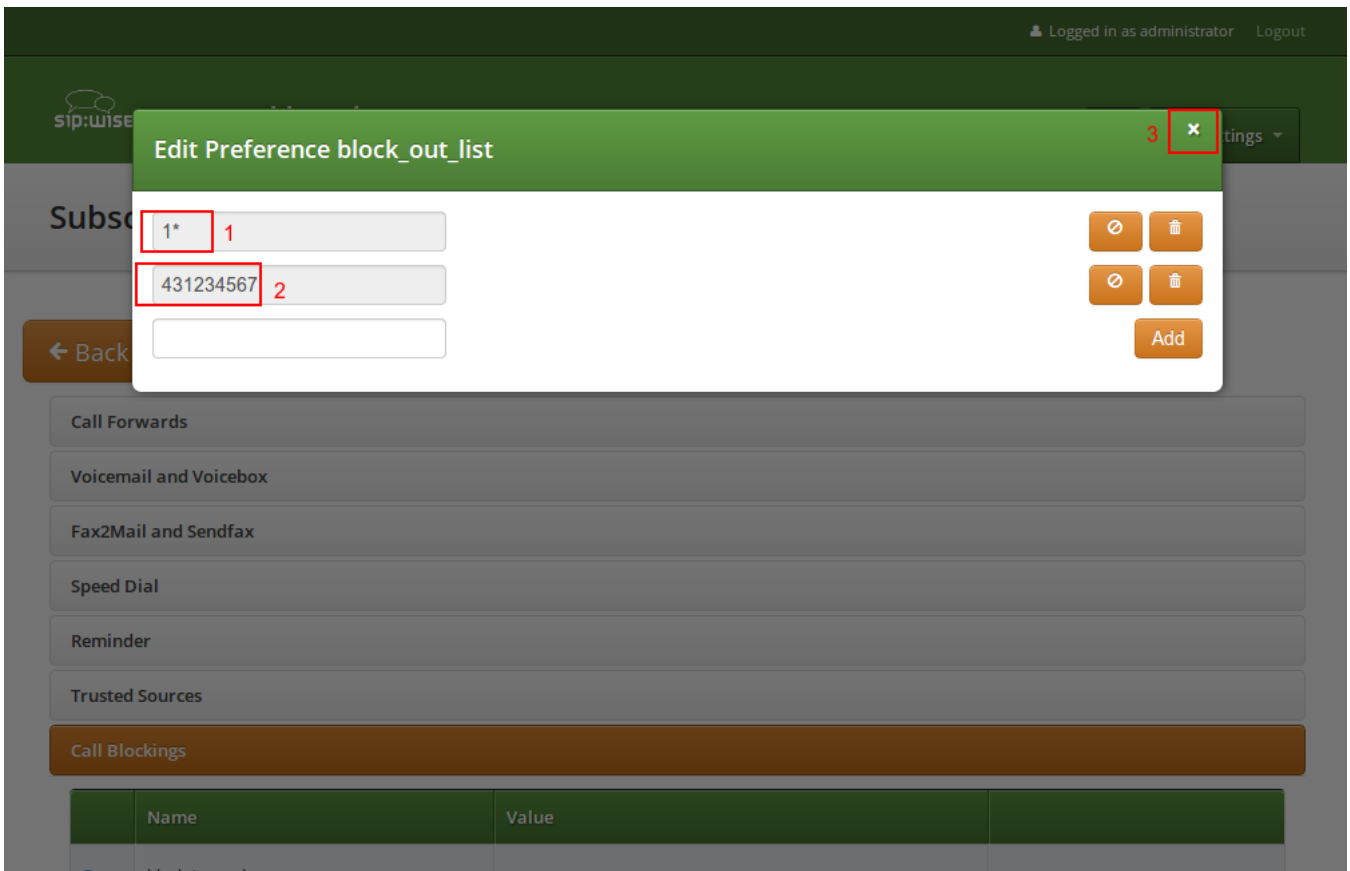

Click the *Close* icon once you're done editing your list.

### Block Anonymous Numbers

For incoming call, the User Preference *block\_in\_clir* and *adm\_block\_in\_clir* controls whether or not to reject incoming calls with number suppression (either "[A]nonymous" in the display- or user-part of the From-URI or a header *Privacy: id* is set). This flag is independent from the Block Mode.

### 7.3.2. NCOS (Network Class of Service) Levels

*NCOS Levels* provide predefined lists of allowed or denied destinations for outbound calls of local subscribers. Compared to *Block Lists*, they are much easier to manage, because they are defined on a global scope, and the individual levels can then be assigned to each subscriber. Again there is the distinction for the user- and administrative- levels.

In a case of a conflict, when the Block Lists feature allows a number and NCOS Levels rejects the same number or vice versa, the call will be rejected.

NCOS levels can either be *whitelists* or *blacklists*.

- The *blacklist* mode indicates to **allow everything except the entries in this level**. Use this mode if you want to block specific destinations and allow all the rest.

- The *whitelist* mode indicates to **reject anything except the entries in this level**. Use this mode if you want to enforce a strict policy and allow only selected destinations.

NCOS levels can also have a [Timeset](#) associated which will enable the NCOS level check only within the time window defined. By default, in case the day time is outside the defined time window, the NCOS level check is skipped. Use the flag: "Timeset Invert" to match the timeset in the opposite way: skip the NCOS level check in case the day time is inside the defined time window.

The *Expose to Customer* flag allows the customer's administrator subscribers to see and set the NCOS level in the CSC portal. This allows them to autonomously configure the NCOS level for all the subscribers belonging to the same customer.

ATTENTION: when the *Expose to Customer* flag of an NCOS level is switched from set to unset, all assigned NCOS preferences for customers and subscribers that contain the NCOS Level are removed. That means that those customers and subscribers will not have any NCOS level assigned other than the administrative ones (adm\_ncos and adm\_cf\_ncos).

## Creating NCOS Levels

To create an NCOS Level, go to *Settings* *NCOS Levels* and press the *Create NCOS Level* button.

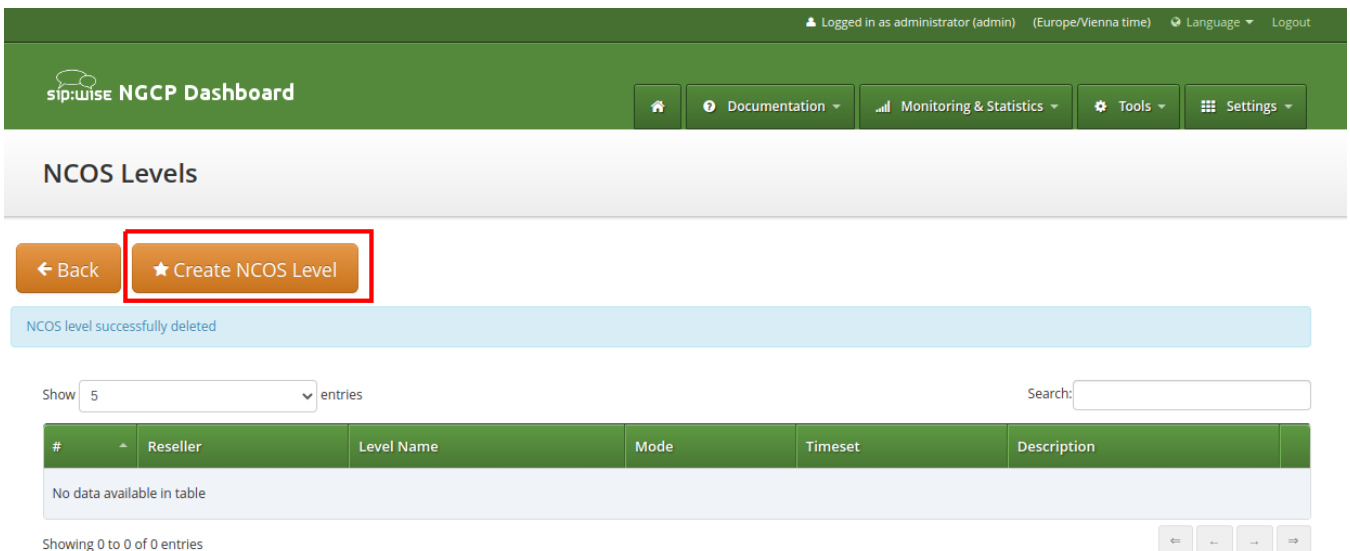

Logged in as administrator (admin) (Europe/Vienna time) Language Logout

sip:wise NGCP Dashboard

Documentation Monitoring & Statistics Tools Settings

### NCOS Levels

← Back ★ Create NCOS Level

NCOS level successfully deleted

Show 5 entries Search:

#	Reseller	Level Name	Mode	Timeset	Description
No data available in table					

Showing 0 to 0 of 0 entries

Select a reseller, enter a name, select the mode, add a description:

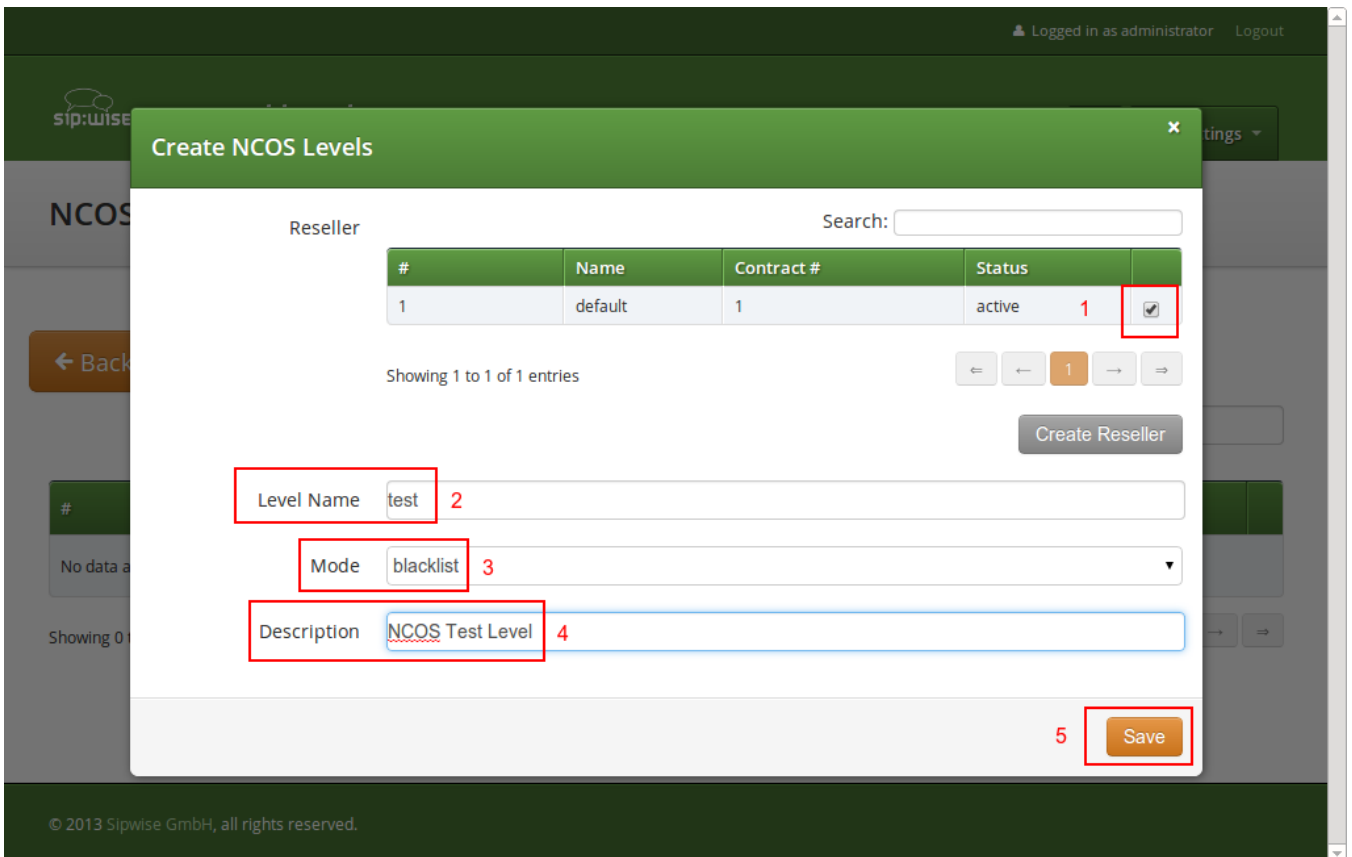

and, if necessary, assign a timeset then click the *Save* button.

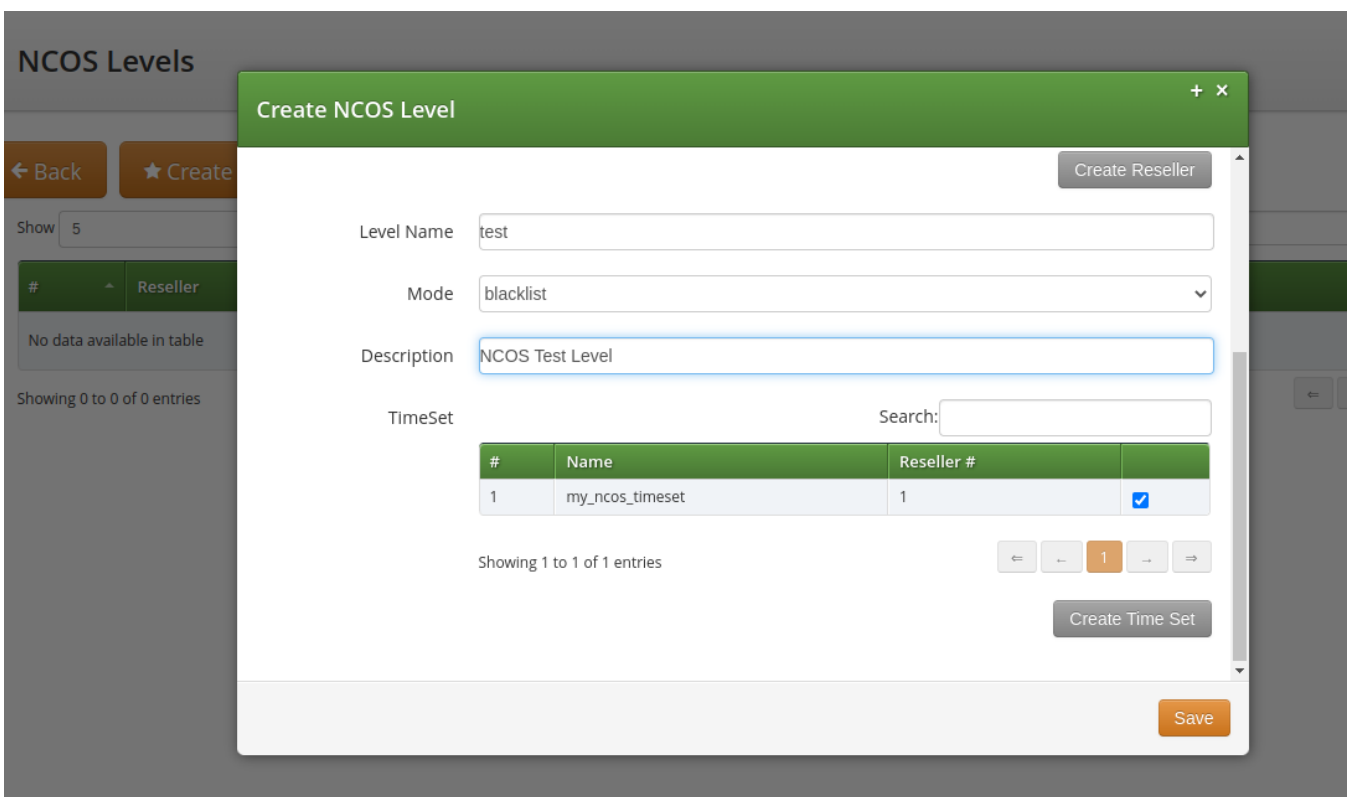

### Creating Rules per NCOS Level

To define the rules within the newly created NCOS Level, click on the *Patterns* button of the level.

← Back   ★ Create NCOS Level

NCOS level successfully created

Show 5 entries   Search:

#	Reseller	Level Name	Mode	Timeset	Description	
25	default	test	blacklist	my_ncos_timeset	NCOS Test Level	<input type="button" value="Edit"/> <input type="button" value="Delete"/> <input type="button" value="Patterns"/>

Showing 1 to 1 of 1 entries  

There are 2 groups of patterns where you can define matching rules for the selected NCOS Level:

- NCOS Number Patterns: here you can define number patterns that will be matched against the called number and allowed or blocked, depending on whitelist / blacklist mode. The patterns are regular expressions.
- NCOS LNP Carriers: here you can select predefined *LNP Carriers* that will be allowed (whitelist mode) or prohibited (blacklist mode) to route calls to them. For each of them you can restrict the matching to a predefined number pattern. (See [Local LNP Database](#) in the handbook for the description of LNP functionality)

#### NOTE

Sipwise C5 performs number matching always with the dialed number and not with the number generated after LNP lookup that is: either the original dialed number prefixed with an LNP carrier code, or the routing number.

**NCOS Number Patterns**

← Back   ★ Create Pattern Entry

NCOS pattern successfully created

Show 5 entries   Search:

#	Pattern	Description
1	^439	Austrian Premium Numbers

Showing 1 to 1 of 1 entries

Include local area code  
 Intra PBX Calls within same customer

Edit

**NCOS LNP Carriers**

★ Create LNP Entry

Show 5 entries   Search:

#	LNP Carrier	Description
1	LNP_Carr1	Rule for LNP Carrier 1

Showing 1 to 1 of 1 entries

Figure 56. NCOS Patterns List

In the **NCOS Number Patterns** view you can create multiple patterns to define your level, one after the other. Click on the *Create Pattern Entry* Button on top and fill out the form.

**Create Number Pattern** ×

Pattern

Description

Save

Figure 57. Create NCOS Number Pattern

In this example, we block (since the mode of the level is *blacklist*) all numbers starting with 439. Click the *Save* button to save the entry in the level.

There are **2 options** that help you to easily define specific number ranges that will be allowed or blocked, depending on whitelist / blacklist mode:

- *Include local area code*: all subscribers within the caller's local area, e.g. if a subscriber has country-code 43 and area-code 1, then selecting this checkbox would result in the implicit number pattern: ^431.

- *Intra PBX calls within same customer*: all subscribers that belong to the same PBX customer as the caller himself.

In the **NCOS LNP Carriers** view you can select specific LNP Carriers—i.e. carriers that host the called ported numbers—that will be allowed or blocked for routing calls to them (whitelist / blacklist mode, respectively).

An example of *NCOS LNP Carrier* definition:

**NCOS LNP Carriers**

★ Create LNP Entry

Show 5 entries Search:

#	LNP Carrier	Description	
93	LNP_Carr1	Rule for LNP Carrier 1	<a href="#">Edit</a> <a href="#">Delete</a> <a href="#">Patterns</a>

Showing 1 to 1 of 1 entries

Figure 58. Create NCOS LNP Carrier

In the above example we created a rule that blocks calls to "LNP\_Carr1" carrier, supposing we use blacklist mode of the NCOS Level.

In the **LNP NCOS Number Patterns** view you can create multiple patterns to restrict *NCOS LNP Carrier* matching, one after the other. Click on the *Create LNP Pattern Entry* Button on top and fill out the form.

**LNP Patterns for LNP\_Carr1**

← Back ★ Create LNP Pattern Entry

NCOS pattern successfully created

Show 5 entries Search:

#	Pattern	Description	
99	^390	Restrict_LNP_Carr_1	

Showing 1 to 1 of 1 entries

Figure 59. Create NCOS LNP Carrier Pattern

Considering the example before and adding the pattern shown in the picture, the rule now blocks only calls to "LNP\_Carr1" carrier that starts with 390.

**TIP**

There might be situations when phone number patterns may not be strictly aligned with telephony providers, for instance in case of full number portability in a country. In such cases using *NCOS LNP Carriers* patterns still allows for defining NCOS levels that allow / block calls to mobile numbers, for example. In order to achieve this goal you have to list all LNP carriers in the NCOS patterns that are known to host mobile numbers.

The below table gives an overview of all the possible combinations of *NCOS* and *NCOS LNP Carrier*:

Table 11. NCOS combinations

TYPE	NCOS	NCOS_LNP	RESULT
Whitelist	empty table	empty table	Blocked
Whitelist	empty table	no match	Blocked
Whitelist	empty table	match	Allowed
Whitelist	no match	empty table	Blocked
Whitelist	no match	no match	Blocked
Whitelist	no match	match	Blocked
Whitelist	match	empty table	Allowed
Whitelist	match	no match	Blocked
Whitelist	match	match	Allowed
Blacklist	empty table	empty table	Allowed
Blacklist	empty table	no match	Allowed
Blacklist	empty table	match	Blocked
Blacklist	no match	empty table	Allowed
Blacklist	no match	no match	Allowed
Blacklist	no match	match	Blocked
Blacklist	match	empty table	Blocked
Blacklist	match	no match	Blocked
Blacklist	match	match	Blocked

The parameter `kamailio.proxy.lnp.strictly_check_ncos` contained in `/etc/ngcp-config/config.yml` specify whether the NCOS LNP should be evaluated even if the LNP lookup was not previously executed (because not required by the inbound/outbound call) or if it didn't return any occurrence. If set to *yes*, a whitelist NCOS will fail if the LNP lookup doesn't return any match. The parameter has no impact on blacklist NCOS.

### Assigning NCOS Levels to Subscribers/Domains

Once you've defined your NCOS Levels, you can assign them to local subscribers. To do so, navigate to *SettingsSubscribers*, search for the subscriber you want to edit, press the *Details* button and go to the *Preferences View*. There, press the *Edit* button on either the *ncos* or *adm\_ncos* setting in the *Call Blockings* section.

Call Blockings			
	Name	Value	
1	<input type="checkbox"/> block_in_mode	<input type="checkbox"/>	
	<input type="checkbox"/> block_in_list		
	<input type="checkbox"/> block_in_clir	<input type="checkbox"/>	
	<input type="checkbox"/> block_out_mode	<input type="checkbox"/>	
	<input type="checkbox"/> block_out_list	1* 431234567	
	<input type="checkbox"/> adm_block_in_mode	<input type="checkbox"/>	
	<input type="checkbox"/> adm_block_in_list		
	<input type="checkbox"/> adm_block_in_clir	<input type="checkbox"/>	
	<input type="checkbox"/> adm_block_out_mode	<input type="checkbox"/>	
	<input type="checkbox"/> adm_block_out_list		
	<input type="checkbox"/> ncos 2	<input type="text" value=""/>	3 <input type="button" value="Edit"/>

You can assign the NCOS level to all subscribers within a particular domain. To do so, navigate to *SettingsDomains*, select the domain you want to edit and click *Preferences*. There, press the *Edit* button on either *ncos* or *admin\_ncos* in the *Call Blockings* section.

Note: if both domain and subscriber have same NCOS preference set (either *ncos* or *adm\_ncos*, or both) the subscriber's preference is used. This is done so that you can override the domain-global setting on the subscriber level.

### Assigning NCOS Level for Forwarded Calls to Subscribers/Domains

In some countries there are regulatory requirements that prohibit subscribers from forwarding their numbers to special numbers like emergency, police etc. While Sipwise C5 does not deny provisioning Call Forward to these numbers, the administrator can prevent the incoming calls from being actually forwarded to numbers defined in the NCOS list: select the appropriate NCOS level in the domain's or subscriber's preference *adm\_cf\_ncos*. This NCOS will apply only to the Call Forward from the subscribers and not to the normal outgoing calls from them.

### NCOS exceptions

Using the subscriber's preference "adm\_ncos\_exceptions" an administrator can configure exceptions per subscriber to assigned NCOS Levels. In case a called number matches one of the 'adm\_ncos\_exceptions' preference entries, then all the NCOS Level checks (administrative or not) are skipped and the call will be accepted.

### 7.3.3. NCOS Sets

*NCOS Sets* provides the possibility to create a Set of *NCOS Levels*. Multiple *NCOS Levels*, with different

rules and modes, can be grouped together in a *NCOS Set* which can be assigned to a local subscriber or a local domain. This is suitable in case you need to group different levels with different modes (*whitelist* and *blacklist*) and build more efficient NCOS rules. In order for a call to pass the *NCOS Sets* check, it must fulfill all the *NCOS Levels* that belong to the Set, otherwise, the call will be rejected.

## Creating NCOS Set

To create an NCOS Set, go to SettingsNCOS Sets and press the Add button.



Mandatory parameters are reseller, name and description.

The *Expose to Customer* flag allows the customer's administrator subscribers to see and set the NCOS Set in the CSC portal. This allows them to autonomously configure the NCOS Set for all the subscribers belonging to the same customer.

ATTENTION: when the *Expose to Customer* flag of an NCOS Set is switched from set to unset, all assigned NCOS preferences for customers and subscribers that contain the NCOS Set are removed. That means that those customers and subscribers will not have any NCOS Set assigned other than the administrative ones (*adm\_ncos\_set* and *adm\_cf\_ncos\_set*).

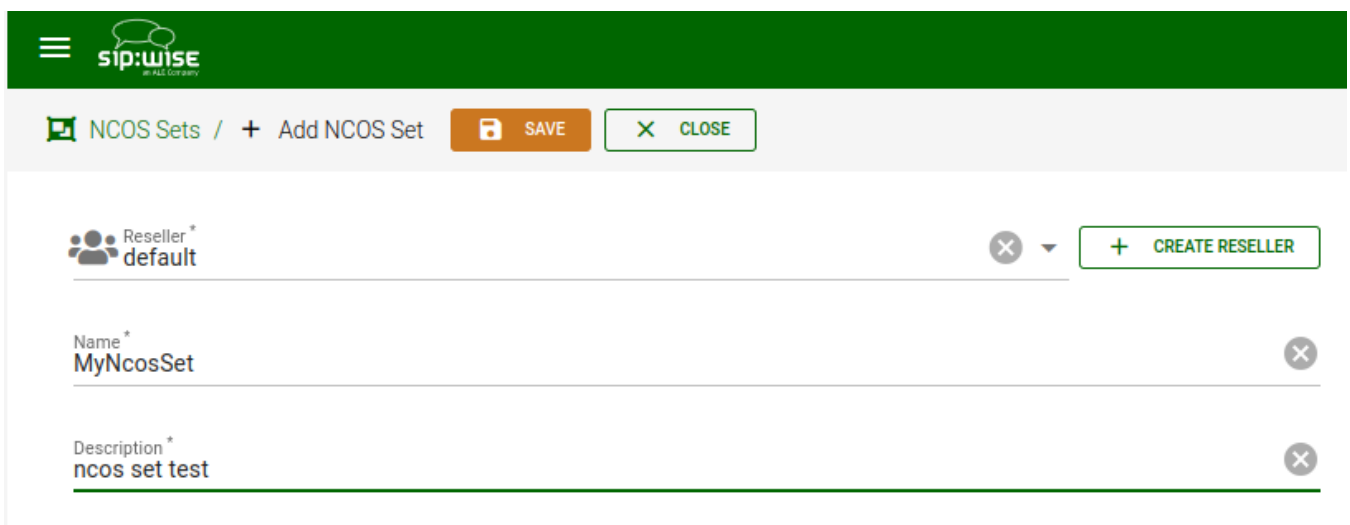

## Add Levels to NCOS Set

To add NCOS levels to the NCOS Set, click on the three dots and then to *Levels*

There are two sections in the *Levels* page, the first section shows the *Selected NCOS Levels* and the second one the list of all available NCOS Levels.

In order to add a Level to the set, click on the three dots of a level and select *Add*. The selected level will be added to the set, but it will not be removed from the available list, because the same level can be assigned to different sets.

## Assigning NCOS Sets to Subscribers/Domains

Once you've defined your NCOS Sets, you can assign them to local subscribers or domains. To do so, navigate to *SettingsSubscribers*, search for the subscriber you want to edit, press the *Details* button and go to the *Preferences View*. There, press the *Edit* button on either the *ncos\_set* or *adm\_ncos\_set* setting in the *Call Blockings* section.

•	ncos_set	NCOS Set	<input type="text"/>	<input type="button" value="Edit"/>
•	adm_ncos_set	Administrative NCOS Set	<input type="text"/>	
•	adm_cf_ncos_set	Administrative NCOS Set for Call Forward	<input type="text"/>	

### Assigning NCOS Set for Forwarded Calls to Subscribers/Domains

In some countries there are regulatory requirements that prohibit subscribers from forwarding their numbers to special numbers like emergency, police etc. While Sipwise C5 does not deny provisioning Call Forward to these numbers, the administrator can prevent the incoming calls from being actually forwarded to numbers defined in the NCOS list: select the appropriate NCOS set in the domain's or subscriber's preference *adm\_cf\_ncos\_set*. This NCOS will apply only to the Call Forward from the subscribers and not to the normal outgoing calls from them.

### NCOS Set exceptions

The subscriber's preference "adm\_ncos\_exceptions", mentioned before, is valid also for the NCOS Sets. In case a called number matches one of the 'adm\_ncos\_exceptions' preference entries, then all the NCOS Set checks (administrative or not) are skipped and the call will be accepted.

### 7.3.4. IP Address Restriction

The Sipwise C5 provides subscriber and domain preference *allowed\_ips* to restrict the IP addresses that a particular subscriber or any subscribers within the respective domain is allowed to use the service from. If the REGISTER or INVITE request comes from an IP address that is not in the allowed list, Sipwise C5 will reject it with a 403 message. Also a voice message can be played when the call attempt is rejected (if configured).

By default, *allowed\_ips* is an empty list which means that subscriber is not restricted. If you want to configure a restriction, navigate to *SettingsSubscribersPreferences* or *SettingsDomainsPreferences*, and search for the *allowed\_ips* preference in the *Access Restrictions* section.

Call Blockings			
Access Restrictions			
1	Name	Value	
	lock		
	concurrent_max		
	concurrent_max_out		
	allowed_clis		
	reject_emergency	<input type="checkbox"/>	
	concurrent_max_per_account		
	concurrent_max_out_per_account		
	allowed_ips 2		3 <input type="button" value="Edit"/>
	man_allowed_ips		
	ignore_allowed_ips	<input type="checkbox"/>	
	allow_out_foreign_domain	<input type="checkbox"/>	

Press the Edit button to the right of empty drop-down list.

You can enter multiple allowed IP addresses or IP address ranges one after another. Click the *Add* button to save each entry in the list. Click the *Delete* button if you want to remove some entry.

### 7.3.5. CLI-based Access Control

The Sipwise C5 provides subscriber preference *upn\_block\_list* to restrict the CLI that subscriber is allowed to use the service from. If the INVITE request comes with a CLI that is not in the allowed list, Sipwise C5 will reject it with a 403 message. Also a voice message can be played when the call attempt is rejected (if configured).

The restriction is applied to User-Provided Number (UPN) which is obtained from the configurable source based on the setting of *inbound\_upn* preference in the *Number Manipulation* section in the Domain and/or User preferences, after it has been rewritten with Inbound Rewrite Rules for Caller.

In case the *inbound\_upn* preference is set to the "From Display-Name" the UPN value can be alphanumeric so the access control supports the alphanumeric (caller name) matching as well. If the incoming message does not have the Display-Name, though, the UPN value will be taken from the From-Username.

The *inbound\_upn* preference has a slightly different meaning if *kamailio.proxy.multiple\_headers\_for\_valid\_upn* is set to yes inside config.yml.

In this particular case the *inbound\_upn* preference only defines which Sip Header must be checked first and, in case of failure, the check is repeated evaluating the username part of the following headers:

- P-Preferred-Identity

- P-Asserted-Identity
- From

In case of positive result, that value will be used as valid UPN and the subsequent headers will be not evaluated, otherwise if all additional checks fail, restrictions are applied as described above.

By default, *upn\_block\_list* is an empty list which means that subscriber is not restricted. If you want to configure a restriction, navigate to *SettingsSubscribers*, search for the subscriber you want to edit, press *Details* and then *Preferences* and press *Edit* for the *upn\_block\_list* preference in the *Call Blockings* section to define the list entries.

In block list entries, you can provide shell patterns like \* and []. The CLI-based block list can either be *whitelist* or *blacklist*.

- The *blacklist* mode indicates to **allow everything except the entries in this list**. This is the default mode of operation and is effective when the preference *upn\_block\_mode* is unset.
- The *whitelist* mode indicates to **reject anything except the entries in this list**. In order to switch to this mode, set the preference *upn\_block\_mode* (it is a toggle between whitelist/blacklist).

If separate preference *upn\_block\_clir* is enabled, outgoing anonymous calls from this user will be dropped.

If the caller's UPN is allowed it is also checked according to *allowed\_clis* preference as usual and can be rewritten according to *allowed\_clis\_reject\_policy* for correct calling number presentation on outgoing calls. This step happens after Access Control.

### 7.3.6. Call Limit Control

There's a set of preferences that limits calls to and from subscribers. The option *concurrent\_max\_total* defines the maximum number of concurrent calls (incoming and outgoing) for a subscriber, while the option *concurrent\_max\_out\_total* limits only subscriber's outbound concurrent calls and the option *concurrent\_max\_in\_total* only subscriber's inbound concurrent calls.

Preferences *concurrent\_max*, *concurrent\_max\_out*, and *concurrent\_max\_in* have the same effect, excluding calls to voicemail, application server and intra-PBX calls.

It's also possible to limit the number of concurrent calls of a subscriber compared to the number of calls made or received by all subscribers within the same customer (account). The options *concurrent\_max\_per\_account*, *concurrent\_max\_out\_per\_account*, *concurrent\_max\_in\_per\_account* permit to apply this limit. To better understand how they work, suppose we have two subscribers A and B, owned by the same customer. If we set *concurrent\_max\_per\_account=2* on B preferences and A is placing two calls, then B can not receive or place new calls at the same time. For instance, an administrator may define this restriction to some non-manager subscribers, in which *concurrent\_max\_per\_account=2*. Hence, they will be able to make a maximum of two calls if there are no other calls in place within the customer. On manager subscribers, the limit can be defined differently, or even not set at all. In the last case, calls will be always allowed.

When *concurrent\_max\_total* limit is reached, announcement set on *max\_calls\_in* is played to those who try to call that subscriber. The same announcement is played for *concurrent\_max*, *concurrent\_max\_per\_account*, *concurrent\_max\_in\_total*, *concurrent\_max\_in*, *concurrent\_max\_in\_per\_account*. When *concurrent\_max\_out\_total* limit is reached, announcement set on *max\_calls\_out* is played. The same announcement is played for *concurrent\_max\_out* or

*concurrent\_max\_out\_per\_account*.

Options *concurrent\_max*, *concurrent\_max\_out* and *concurrent\_max\_in* are configurable on peers as well.

Furthermore, options *concurrent\_max*, *concurrent\_max\_out*, *concurrent\_max\_in* and their *\_total* version (*concurrent\_max\_total* and so on), are configurable on customer and reseller as well. In this case the limits are applied considering the number of calls of all the subscribers belonging to that account/reseller.

## 7.4. Call Forwarding and Call Hunting

The Sipwise C5 provides the capabilities for normal *call forwarding* (deflecting a call for a local subscriber to another party immediately or based on events like the called party being busy or doesn't answer the phone for a certain number of seconds) and *serial call hunting* (sequentially executing a group of deflection targets until one of them succeeds). Targets can be stacked, which means if a target is also a local subscriber, it can have another call forward or hunt group which is executed accordingly.

### 7.4.1. Call Forward Types

Currently 7 different types of Call Forward are available in Sipwise C5:

- **Call Forward Unconditional (CFU):** The call forward is always executed, completely disregarding the subscriber state.
- **Call Forward Busy (CFB):** The call forward is executed when the subscriber returns a busy state.
- **Call Forward Timeout (CFT):** The call forward is executed when no answer is received from the subscriber before the timeout expiration. Timeout is configurable in *ringtimeout* subscriber preference.
- **Call Forward Unavailable (CFNA):** The call forward is executed when the subscriber has no endpoint registered.

#### CAUTION

The Call Forward Unavailable is also executed if the callee responds with *480 Temporarily Unavailable*, which may be the case when a subscriber's endpoint (e.g. an IP-PBX) is registered but the callee user is not available.

- **Call Forward SMS (CFS):** The SMS forward is always executed, completely disregarding the subscriber state. SMS service has to be enabled, see the [SMS \(Short Message Service\)](#) subchapter for a detailed description on how to activate it.
- **Call Forward on Response (CFR):** The call forward is executed only for particular reply codes received back from the destination endpoint. The list of the reply codes and the activation mode can be configured in *rerouting\_codes* and *rerouting\_mode* subscriber's preferences. Example: suppose that *rerouting\_codes* is set to 503, *rerouting\_mode* to *whitelist* and the CFR is configured. If that subscriber receives a call and it replies back a with code 503, then the call will be re-routed to the destination configured in the CFR. For all the other reply codes the CFR will be NOT executed.
- **Call Forward on Overflow (CFO):** The call forward is executed when the new incoming call for the subscriber exceeds the limit configured in *concurrent\_max\_in\_total*, *concurrent\_max\_in* or *concurrent\_max\_in\_per\_account* subscriber's preferences. If none of the preferences is set then the CFO will be NOT executed.

## 7.4.2. Setting a simple Call Forward

Go to your *Subscriber Preferences* and click *Edit* on the Call Forward Type you want to set (e.g. *Call Forward Unconditional*).

### Edit Call Forward Unconditional

Destination  Voicemail  
 Conference  
 Fax2Mail  
 Calling Card  
 Custom Announcement  
 Local Subscriber  
 URI/Number

URI/Number

for (seconds)

Enabled

Use redirection

If you select *URI/Number* in the *Destination* field, you also have to set a *URI/Number*. The timeout defines for how long this destination should be tried to ring.

## 7.4.3. Call Forward Destinations

- **Voicemail:** Calls are forwarded to the Voicemail Application Server where the caller can leave a message.
- **Conference:** Calls are forwarded to the conference room. The subscriber is the host of the conference.
- **Fax2Mail:** Calls are forwarded to the Fax Server and the caller is supposed to leave a fax message. Note: The Fax2Mail feature must be enabled in the subscriber's preferences.
- **Custom Announcement:** A custom announcement is played back to the caller. Select an announcement from the *Custom announcement* list.
- **Manager Secretary:** Calls are forwarded to numbers defined in the "manager\_secretary\_numbers" subscriber preference. The "manager\_secretary" feature must be enabled.

- **URI/Number:** The call is forwarded to the provided SIP-URI string or a number (See the *Call Forward Destination Extra Parameters* section below).

### Call Forward Destination Options

- **URI/Number:** A destination to forward calls to. This option is only valid for the *URI/Number* destination type. Specify a valid SIP-URI string or a plain number.
- **for (seconds):** Sets the ringing time, after which the call is forwarded to the next number on the list (if configured).
- **Custom Announcement:** Custom Announcements are created in Sound Sets and must have the name like 'custom\_announcement\_0', where the trailing symbol is a digit from 0 to 9.
- **Enabled:** Defines whether the Call Forward rule is being used or not.
- **Use redirection:** If enabled and only for calls coming from PSTN, the callforward is performed as a redirection and Sipwise C5 will reply with a "302 Moved Temporarily" message, the new destination is set in the Contact header.

### 7.4.4. Advanced Call Hunting

Beside call forwarding to a single destination, Sipwise C5 offers the possibility to activate call forwarding in a more sophisticated way:

- to multiple destinations ( *Destination Set* )
- only during a pre-defined time set ( *Time Set* )
- only for specific callers ( *Source Set* )
- only for specific callee ( *B-Number Set* )

If you want to define such more detailed call forwarding rules, you need to change into the *Advanced View* when editing your call forward. There, you can select multiple *Destination Set - Time Set - Source Set - B-Number Set* groups that determine all conditions under which the call will be forwarded.

#### Explanation of call forward parameters

- A **Destination Set** is a list of destinations where the call will be routed to, one after another, according to the order of their assigned priorities. See the [Destination Sets](#) subchapter for a detailed description.
- A **Time Set** is a time period definition, i.e. when the call forwarding has to be active. See the [Time Sets](#) subchapter for a detailed description.
- A **Source Set** is a list of number patterns that will be matched against the calling party number; if the calling number matches the call forwarding will be executed. See the [Source Sets](#) subchapter for a detailed description.
- A **B-Number Set** is a list of number patterns that will be matched against the called party number; if the callee number matches the call forwarding will be executed. See the [B-Number Sets](#) subchapter for a detailed description.

### 7.4.5. Show Call Forward Destination to Caller (colp\_cf)

When using extension numbers belonging to the same customer pbx, there is the possibility to take advantage of the "colp\_cf" subscriber preference. If "colp\_cf" subscriber's preference is enabled, during

a call forward, Sipwise C5 will try to send to the original caller some information about the final destination using the P-Asserted-Identity header. This extra header can be read from the calling user agent while ringing or during the conversation, and display the correct forward destination in place of the original dialed destination.

### Configuring Destination Sets

Click on *Manage Destination Sets* to see a list of available sets. The *quickset\_cfu* has been implicitly created during our creation of a simple call forward. You can edit it to add more destinations, or you can create a new destination set.

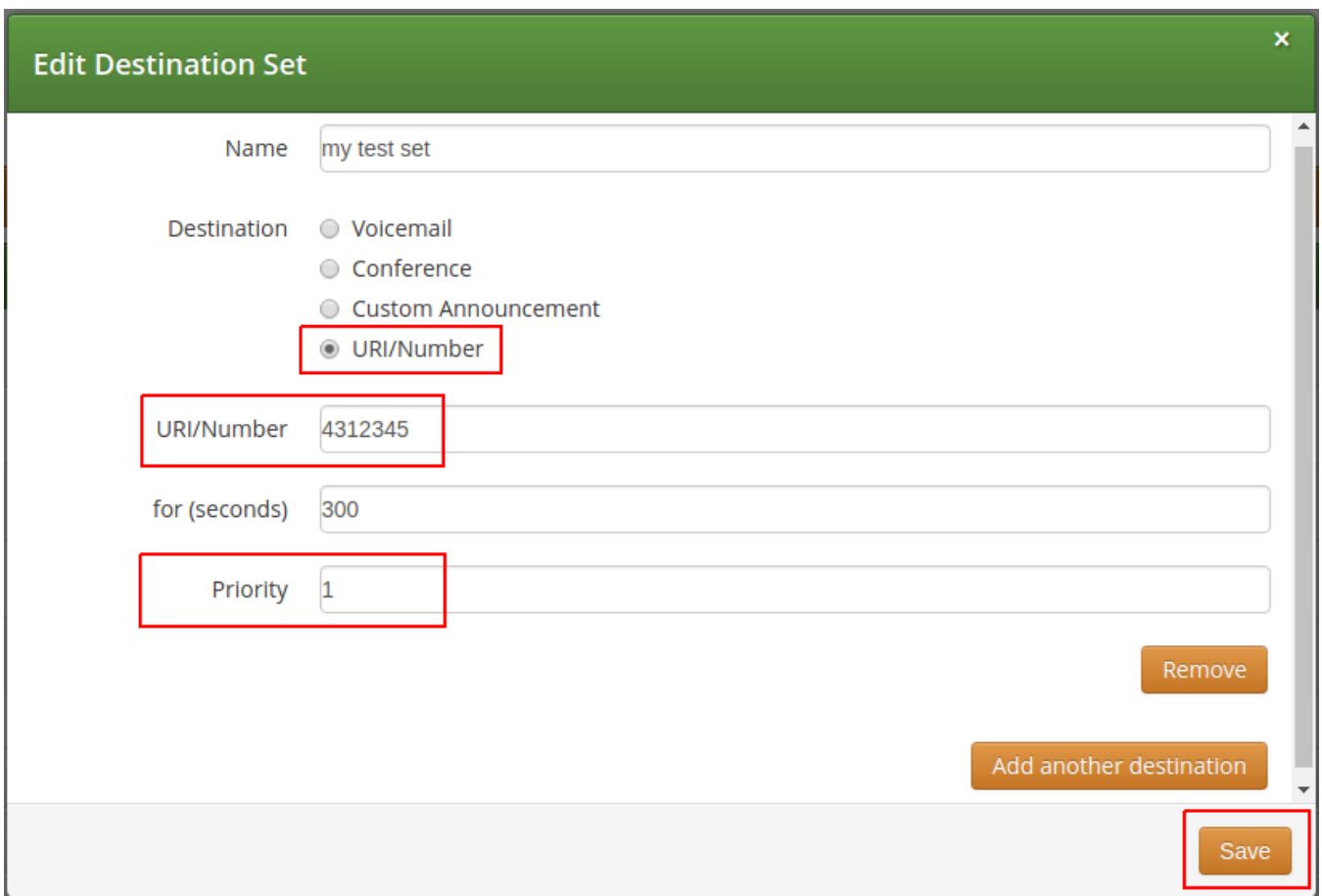

**Edit Destination Set**

Name

Destination

- Voicemail
- Conference
- Custom Announcement
- URI/Number

URI/Number

for (seconds)

Priority

When you close the *Destination Set Overview*, you can now assign your new set in addition or instead of the *quickset\_cfu* set.

### Edit Call Forward Unconditional ✕

during Time Set

from Source Set

to B-Number Set

Destination Set

Enabled

Press *Save* to store your settings.

### Configuring Time Sets

Click on *Manage Time Sets* in the advanced call-forward menu to see a list of available time sets. By default there are none, so you have to create one.

You need to provide a *Name*, and a list of *Periods* where this set is active. If you only set the top setting of a date field (like the *Year* setting in our example above), then it's valid for only this setting (like the full year of 2013 in our case). If you provide the bottom setting as well, it defines a period (like our *Month* setting, which means from beginning of April to end of September). For example, if a CF is set with the following timeset: "hour { 10-12 } minute { 20-30 }", the CF will be matched within the following time ranges:

- from 10.20am to 10:30am
- from 11.20am to 11:30am
- from 12.20am to 12:30am

### IMPORTANT

the period is a *through* definition, so it covers the full range. If you define an *Hour* definition 8-16, then this means from 08:00 to 16:59:59 (unless you filter the *Minutes* down to something else).

If you close the *Time Sets* management, you can assign your new time set to the call forwards you're configuring.

## Configuring Source Sets

Once the *Advanced View* of the call forward definition has been opened, you will need to press the *Manage Source Sets* button to start defining new Source Sets or managing an existing one. The following image shows the Source Set definition dialog:

Figure 60. Creating a Call Forward Source Set

You will need to fill in the Name field first, the Mode: whitelist or blacklist, the is\_regex flag and finally in the Source field you can enter:

- A simple phone number in E.164 format
- A pattern, in order to define a range of numbers. You can use "\*" (matches a string of 0 to any number of characters), "?" (matches any single character), "[abc]" (matches a single character that is part of the explicitly listed set: a, b or c) and "[0-9]" (matches a single character that falls in the range 0 to 9) as wildcards, as usual in shell patterns. Examples:

"431\*" (all numbers from Vienna / Austria)

"49176[0-5]77\*" (German numbers containing fixed digits and a variable digit in 0-5 range in position 6)

"43130120??" (numbers from Vienna with fixed prefix and 2 digits variable at the end)

- A perl compatible regular expressions (only if is\_regex if set). Capturing groups can be formed using parentheses and referenced in the *Destination Set* via `\1`, `\2`,...
- The constant string "anonymous" that indicates a suppressed calling number (CLIR)

You can add more patterns to the Source Set by pressing the *Add another source* button. When you finished adding all patterns, press the *Save* button. You will then see the below depicted list of Source Sets:

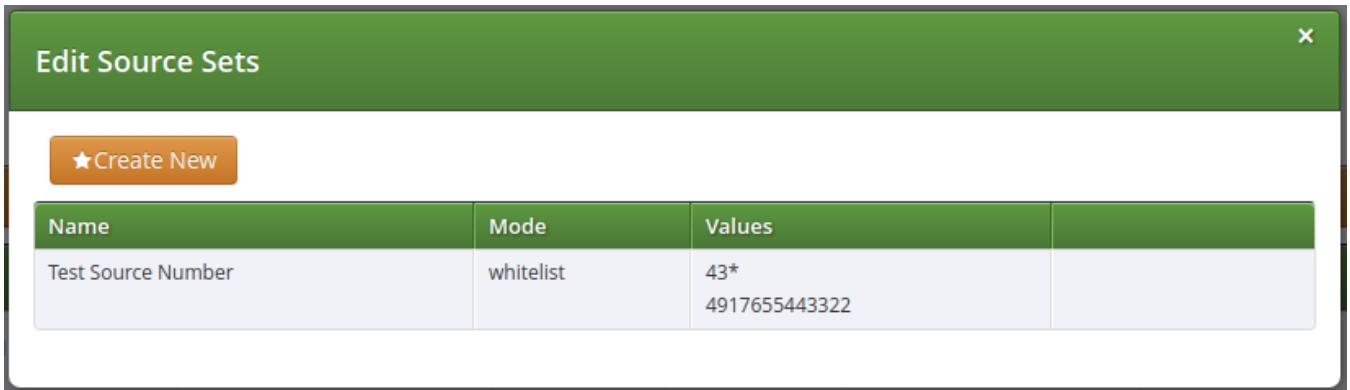

Name	Mode	Values
Test Source Number	whitelist	43* 4917655443322

Figure 61. List of Call Forward Source Sets

### Configuring B-Number Sets

Once the *Advanced View* of the call forward definition has been opened, you will need to press the *Manage B-Number Sets* button to start defining new B-Number Sets or managing an existing one. The following image shows the B-Number Set definition dialog:

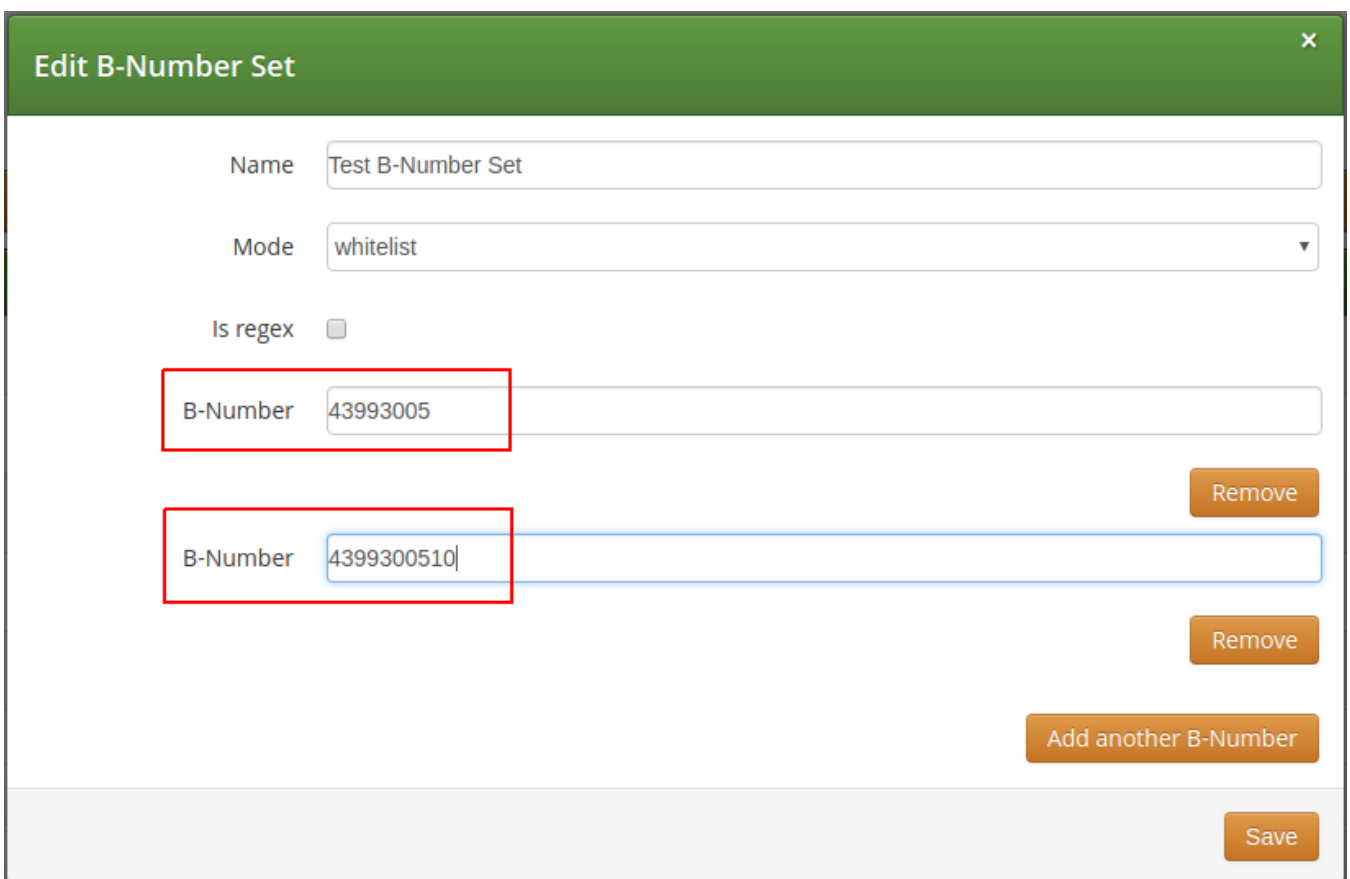

Figure 62. Creating a Call Forward B-Number Set

You will need to fill in the Name field first, the Mode: whitelist or blacklist, the is\_regex flag and finally in the B-Number field you can enter:

- A simple phone number in E.164 format
- A pattern, in order to define a range of numbers. You can use "\*" (matches a string of 0 to any

number of characters), "?" (matches any single character), "[abc]" (matches a single character that is part of the explicitly listed set: a, b or c) and "[0-9]" (matches a single character that falls in the range 0 to 9) as wildcards, as usual in shell patterns. Examples:

"431\*" (all numbers from Vienna / Austria)

"49176[0-5]77\*" (German numbers containing fixed digits and a variable digit in 0-5 range in position 6)

"43130120??" (numbers from Vienna with fixed prefix and 2 digits variable at the end)

- A perl compatible regular expressions (only if `is_regex` if set). Capturing groups can be formed using parentheses and referenced in the *Destination Set* via `\1`, `\2`,...

You can add more patterns to the B-Number Set by pressing the *Add another B-Number* button. When you finished adding all patterns, press the *Save* button. You will then see the below depicted list of B-Number Sets:

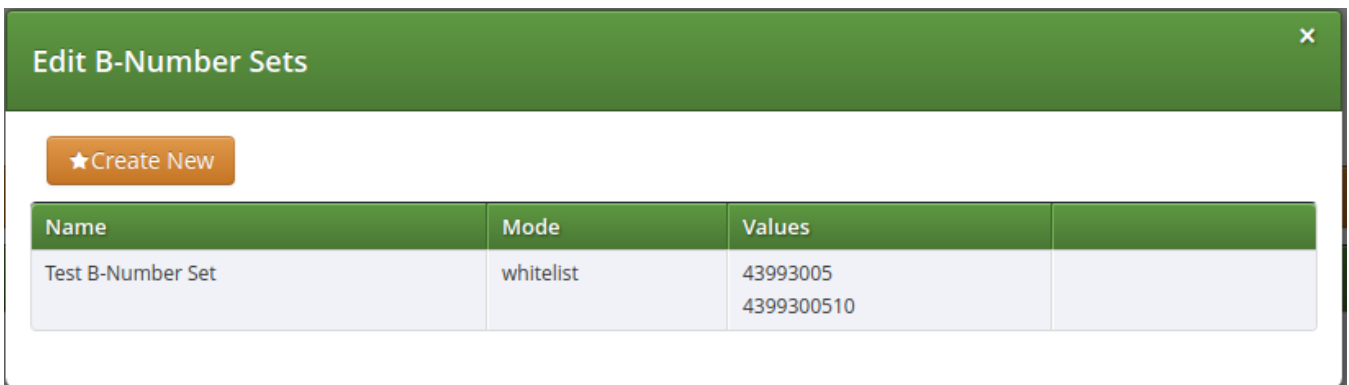

Edit B-Number Sets			
★ Create New			
Name	Mode	Values	
Test B-Number Set	whitelist	43993005 4399300510	

Figure 63. List of Call Forward B-Number Sets

### Finalizing the call forward definition

As additional step you can define a Destination Set as described in [Destination Sets](#) subchapter. For our example, we have defined the following Destination Set:

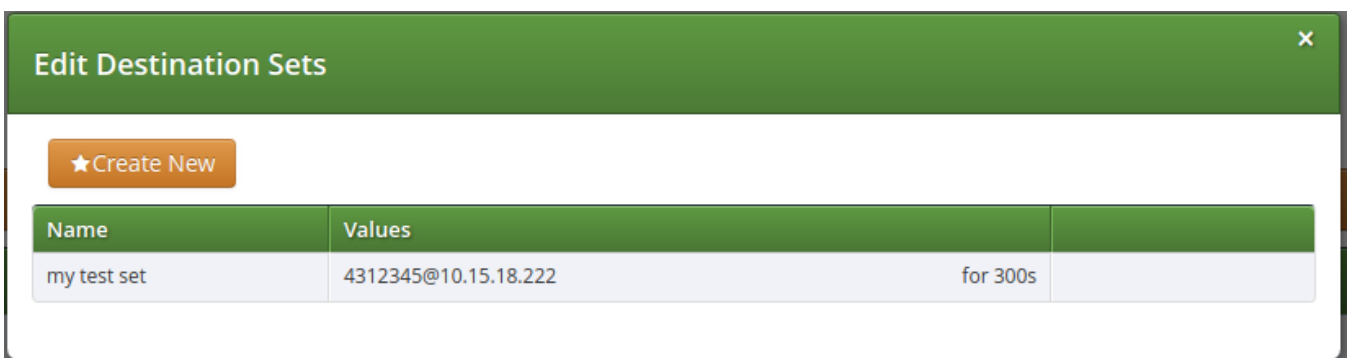

Edit Destination Sets			
★ Create New			
Name	Values		
my test set	4312345@10.15.18.222	for 300s	

Figure 64. List of Call Forward Destination Sets

A final step of defining the call forward settings is selecting a Destination, a Time Set, a Source Set and a B-Number Set, as shown in the image below. *Please note* that there is no specific Time Set selected in our example, that means the call forward rule is valid (as shown) <always>.

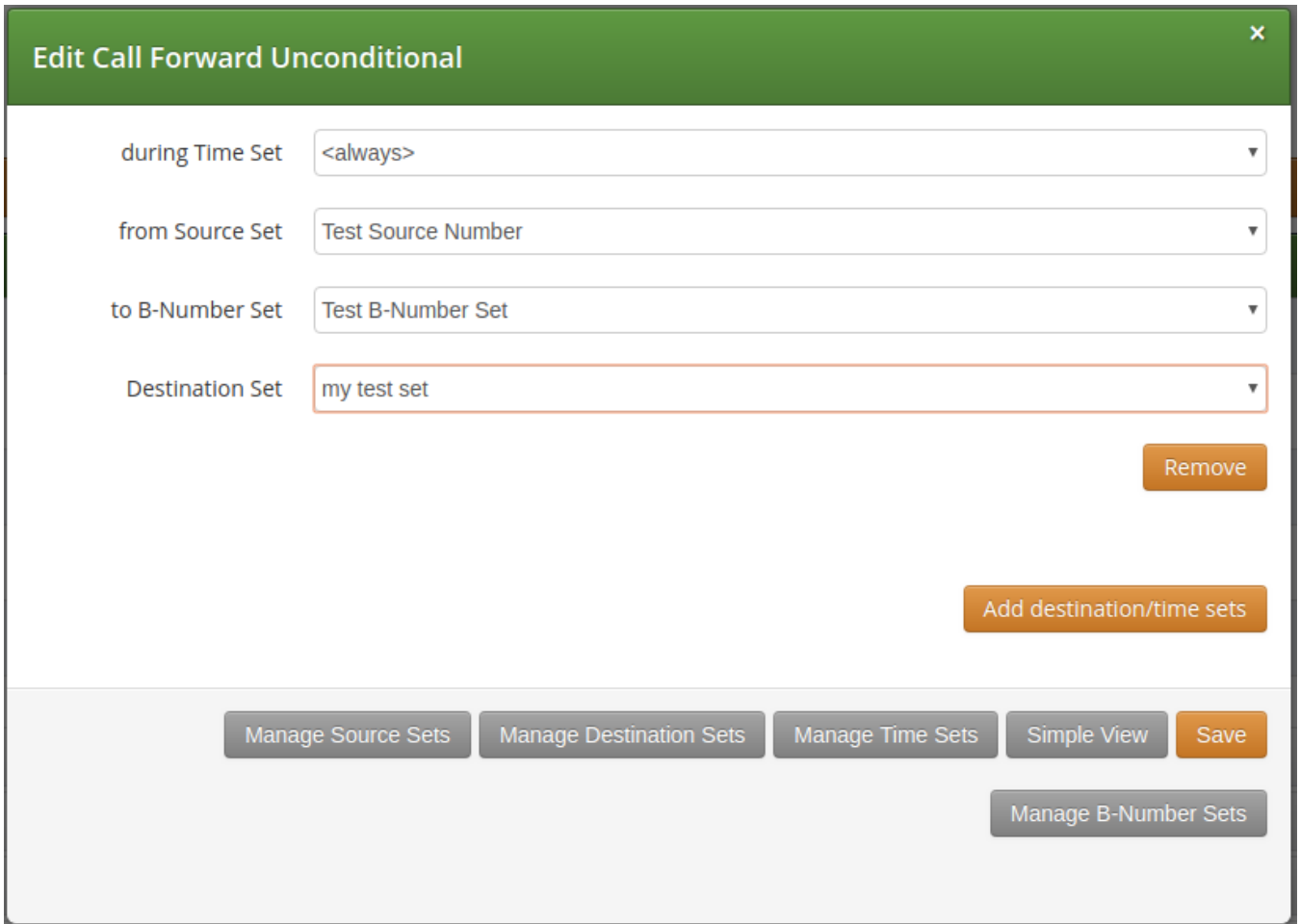

The screenshot shows a web interface for editing a call forward rule. The title bar is green and contains the text "Edit Call Forward Unconditional" and a close button (X). The main area is white and contains four dropdown menus:

- during Time Set: <always>
- from Source Set: Test Source Number
- to B-Number Set: Test B-Number Set
- Destination Set: my test set

Below the Destination Set dropdown is an orange "Remove" button. To the right of the "Destination Set" dropdown is an orange "Add destination/time sets" button. At the bottom of the interface, there is a row of buttons: "Manage Source Sets", "Manage Destination Sets", "Manage Time Sets", "Simple View", and "Save". Below "Simple View" and "Save" is another button: "Manage B-Number Sets".

Figure 65. Definition of a Call Forward with Source and Destination Sets

Once all the settings have been defined and the changes are saved, you will see the call forward entry (in our example: *Call Forward Unconditional*), with the names of the selected Destination, Time Set, Source Sets and B-Number Set provided, at *SubscriberPreferences Call Forwards* location on the web interface:

← Back
Expand Groups

Successfully saved Call Forward

Call Forwards

Type	Answer Timeout	Timeset	Sources	To (B-Numbers)	New Destinations	
Call Forward Unconditional		always	Test Source Number (whitelist) <span style="color: blue;">•</span>	Test B-Number Set (whitelist) <span style="color: blue;">•</span>	my test set <span style="color: blue;">•</span>	
Call Forward Busy						
Call Forward Timeout						
Call Forward Unavailable						
Call Forward SMS						
Call Forward on Response						
Call Forward on Overflow						

Figure 66. List of Call Forward with Source and Destination Sets

## 7.5. Call Forking by Q value

The Sipwise C5 platform allows you to register multiple devices under the same subscriber.

By default, you can register up to 5 devices, but this limit can be adjusted using the *kamailioproxy max\_registrations\_per\_subscriber* setting in the *config.yml* file.

If you want to disable call forking, an alternative is to set *kamailioproxy last\_registration\_only* to "yes." This restricts each subscriber to a single registered device. This behavior is similar to *kamailioproxy max\_registrations\_per\_subscriber*, with the key difference being that it removes all previous registrations and retains only the most recent contact per AoR.

If a customer registers multiple devices, Sipwise C5 – once receives a call for that user – send the call to all the registered devices, in parallel. All the devices will ring at the same time. This is called Parallel Forking, and this is the default behavior. The Sipwise C5 can also do the so-called Serial Forking, which means let ring one device first, then after a timeout let ring the next device, and so on and so forth. The Serial Forking feature can be activated setting subscriber/domain preference *serial\_forking\_by\_q\_value*.

### 7.5.1. The Q value

Serial Forking is based on SIP Contact's parameter called 'Q value', which is a priority number, set by the clients during their Registration. The q value is a floating point number in a range 0 to 1.0 specified as a parameter in the Contact header field.

In case the client doesn't set the q value, Sipwise C5 set a default value of 'q=-1' in the database.

Q value can be also specified during the creation of a subscriber's permanent registration (*Details Registered Devices Create Permanent Registration*).

The Sipwise C5 can apply two different type of algorithm to the q values in order to achieve two different types of serial forking called *standard* and *probability*.

### 7.5.2. The Standard Method

This method uses the q values as a pure priority index. The higher the q value number, the more priority that device has. Contacts with q value 1.0 have maximum priority, so such contacts will be always tried first in serial forking. Contacts with q value 0 have the lowest priority and they will be tried after all other contacts with higher priority.

**NOTE**

In case two or more contacts have the same q value, then they are tried in parallel. This allow to create a very flexible mix of Serial and Parallel forking.

This method can be activated setting *Standard* in subscriber/domain preference *serial\_forking\_by\_q\_value*.

### 7.5.3. The Probability Method

This method uses the q values as the weight of the contact. The higher the q value number, the more probability that the device has to ring first. Equals q values means equals probability to be tried. Contacts with q values equals to 0 or lower are not considered by the ordering algorithm, but added at the end of the list as backup option if all other contacts fail.

**NOTE**

Differently from the *standard* method there is no possibility to have parallel forking. This algorithm can be useful to load-balance the calls in case of endpoints in ACTIVE-ACTIVE configuration.

This method can be activated setting *Probability* in subscriber/domain preference *serial\_forking\_by\_q\_value*.

### 7.5.4. Advanced Configurations

If a subscriber with Serial Forking enabled receives a call, Sipwise C5 calls the registered devices one after the another. The forking is stopped only in the following cases:

- there are no more devices to try to contact
- one of the ringing devices answers the call
- one of the ringing devices replies with the SIP code 600, 603, 604, 606 or one of the response codes defined in *stop\_forking\_code\_lists* subscriber/domain preference.
- a Call Forward on Timeout is set and the ringtimeout is reached.

Sipwise C5 allows you also to define how long each single device has to ring during a Serial Forking call. To do that, set the subscriber/domain preference *contact\_ringtimeout* to the desired value.

**NOTE**

In case both *contact\_ringtimeout* and Call Forward on Timeout are configured, CFT timeout has higher priority. To clarify this concept, please take a look at the following examples: Case 1: CFT timeout lower than the total ringtimeout of the contacts. For example: CFT timeout = 100, *contact\_ringtimeout* = 40 and 3 devices registered: 1st device will ring for 40 seconds, 2nd device will ring for other 40 seconds, 3rd device will ring only for 20 seconds because of the CFT. Case 2: CFT timeout higher than the total ringtimeout of the contacts. For example: CFT timeout = 100, *contact\_ringtimeout* = 40 and 2 devices registered: 1st device will ring for 40 seconds, 2nd device will ring till reaching the CFT timeout (60 seconds in this case).

## 7.6. Local Number Porting

The Sipwise C5 platform comes with two ways of accomplishing local number porting (LNP):

- one is populating the integrated LNP database with porting data,
- the other is accessing external LNP databases via the Sipwise LNP daemon using the LNP API.

**NOTE** | Accessing external LNP databases is available for PRO and CARRIER products only.

### 7.6.1. Local LNP Database

The local LNP database provides the possibility to define LNP Carriers (the owners of certain ported numbers or number blocks) and their corresponding LNP Numbers belonging to those carriers. It can be configured on the admin panel in *SettingsNumber Porting* or via the API. The LNP configuration can be populated individually or via CSV import/export both on the panel and the API.

**NOTE** | For huge LNP datasets, there is a CLI importer that also supports an efficient way of applying day-to-day deltas: [LNP Dataset Importer](#).

#### LNP Carriers

LNP Carriers are defined by an arbitrary *Name* for proper identification (e.g. *British Telecom*) and contain a *Prefix* which can be used as routing prefix in LNP Rewrite Rules and subsequently in Peering Rules to route calls to the proper carriers. The LNP prefix is written to CDRs to identify the selected carrier for post processing and analytics purposes of CDRs. LNP Carrier entries also have an *Authoritative* flag indicating that the numbers in this block belong to the carrier operating Sipwise C5. This is useful to define your own number blocks, and in case of calls to those numbers reject the calls if the numbers are not assigned to local subscribers (otherwise they would be routed to a peer, which might cause call loops). Finally the *Skip Rewrite* flag skips executing of LNP Rewrite Rules if no number manipulation is desired for an LNP carrier.

#### LNP Numbers

LNP Carriers contain one or more LNP Numbers. Those LNP Numbers are defined by a *Number* entry in E164 format (<cc><ac><sn>) used to match a number against the LNP database. Number matching is performed on a longest match, so you can define number blocks without specifying the full subscriber number (e.g. a called party number *431999123* is going to match an entry *431999* in the LNP Numbers).

For an LNP Numbers entry, an optional *Routing Number* can be defined. This is useful to translate e.g. premium 900 or toll-free 800 numbers to actual routing numbers. If a Routing Number is defined, the called party number is implicitly replaced by the Routing Number and the call processing is continued with the latter. For external billing purposes, the optional *Type* tag of a matched LNP number is recorded in CDRs.

An optional *Start Date* and *End Date* makes it possible to schedule porting work-flows up-front by populating the LNP database with certain dates, and the entries are only going to become active with those dates. Empty values for start indicate a start date in the past, while empty values for end indicate an end time in the future during processing of a call, allowing to define infinite date ranges. As intervals can overlap, the LNP number record with a start time closest to the current time is selected.

## Enabling local LNP support

Sipwise C5 currently supports different types of local number porting: All Call Query (ACQ), Onward Routing (OR) and Query on Release (QoR).

In order to activate Local LNP lookup during call routing, the feature must be activated in `/etc/ngcp-config/config.yml`. Set these parameters:

- `kamailio->proxy->lnp->enable : yes`
- `kamailio->proxy->lnp->type : local / local_qor`

All Call Query (ACQ) and Onward Routing (OR) methods can be covered by the *type* 'local' and they will be referred as 'local' methods from now onwards. For Query on Release (QoR) the 'local\_qor' type has to be set up and it will be referred as QoR in the rest of the document.

**NOTE** | Query on Release (QoR) LNP type is available for PRO and CARRIER products only.

## Local LNP Routing Procedure

When a call arrives at the system, the calling and called party numbers are first normalized using the *Inbound Rewrite Rules for Caller* and *Inbound Rewrite Rules for Callee* within the rewrite rule set assigned to the calling party (a local subscriber or a peer).

If the called party number is not assigned to a local subscriber, or if the called party is a local subscriber and has the subscriber/domain preference *lnp\_for\_local\_sub* set, the LNP lookup logic is engaged, otherwise the call proceeds without LNP lookup. The further steps assume that LNP is engaged.

If the call originated from a peer, and the peer preference *caller\_lnp\_lookup* is set for this peer, then an LNP lookup is performed using the normalized calling party number. The purpose for that is to find the LNP prefix of the calling peer, which is then stored as *source\_lnp\_prefix* in the CDR, together with the selected LNP number's *type* tag (*source\_lnp\_type*). If the LNP lookup does not return a result (e.g. the calling party number is not populated in the local LNP database), but the peer preference *default\_lnp\_prefix* is set for the originating peer, then the value of this preference is stored in *source\_lnp\_prefix* of the CDR.

Next, an LNP lookup is performed using the normalized called party number. If no number is found (using a longest match), no further manipulation is performed.

If an LNP number entry is found, and the *Routing Number* is set, the called party number is replaced by the routing number. Also, if the *Authoritative* flag is set in the corresponding LNP Carrier, and the called party number is not assigned to a local subscriber, the call is rejected. This ensures that numbers allocated to the system but not assigned to subscribers are dropped instead of routed to a peer.

### IMPORTANT

If the system is serving a local subscriber with only the routing number assigned (but not e.g. the premium number mapping to this routing number), the subscriber will not be found and the call will either be rejected if the called party premium number is within an authoritative carrier, or the call will be routed to a peer. This is due to the fact that the subscriber lookup is performed with the dialled number, but not the routing number fetched during LNP. So make sure to assign e.g. the premium number to the local subscriber (optionally in addition to the routing number if necessary using alias numbers) and do not use the LNP routing number mechanism for number mapping to local subscribers.

Next, if the LNP carrier does not have the *Skip Rewriting* option set, the *LNP Rewrite Rules for Callee* are engaged. The rewrite rule set used is the one assigned to the originating peer or subscriber/domain via the *rewrite\_rule\_set* preference. The variables available in the match and replace part are, beside the standard variables for rewrite rules:

- `${callee_lnp_prefix}`: The prefix stored in the LNP Carrier
- `${callee_lnp_basenum}`: The actual number entry causing the match (may be shorter than the called party number due to longest match)

Typically, you would create a rewrite rule to prefix the called party number with the *callee\_lnp\_prefix* by matching `^([0-9]+)$` and replacing it by `${callee_lnp_prefix}\1`.

Once the LNP processing is completed, the system checks for further preferences to finalize the number manipulation. If the terminating local subscriber or peer has the preference *lnp\_add\_npdi* set, the Request URI user-part is suffixed with `;npdi`. Next, if the preference *lnp\_to\_rn* is set, the Request URI user-part is suffixed with `;rn=LNP_ROUTING_NUMBER`, where *LNP\_ROUTING\_NUMBER* is the *Routing Number* stored for the number entry in the LNP database, and the originally called number is kept in place. For example, if *lnp\_to\_rn* is set and the number *1800123* is called, and this number has a routing number *1555123* in the LNP database, the resulting Request-URI is `sip:1800123;rn=1555123@example.org`.

Finally, the *destination\_lnp\_prefix* in the CDR table is populated either by the prefix defined in the Carrier of the LNP database if a match was found, or by the *default\_lnp\_prefix* preference of the destination peer or subscriber/domain.

### Blocking Calls Using LNP Data

The Sipwise C5 provides means to allow or block calls towards ported numbers that are hosted by particular LNP carriers. Please visit [Creating Rules per NCOS Level](#) in the handbook to learn how this can be achieved.

### Transit Calls using LNP

If a call originated from a peer and the peer preference *force\_outbound\_calls\_to\_peer* is set to *force\_nonlocal\_lnp* (the *if callee is not local and is ported* selection in the panel), the call is routed back to a peer selected via the peering rules.

This ensures that if a number once belonged to your system and is ported out, but other carriers are still sending calls to you (e.g. selecting you as an anchor network), the affected calls can be routed to the carrier the number got ported to.

### QoR LNP Routing Procedure

As for the Local LNP type, when a call arrives at the system, the calling and called party numbers are first normalized using the *Inbound Rewrite Rules for Caller* and *Inbound Rewrite Rules for Callee* within the rewrite rule set assigned to the calling party (a local subscriber or a peer).

If the called party number is not assigned to a local subscriber or it is an offline local subscriber, the LNP lookup logic is engaged using the called number for the query. In the case an LNP number entry is found:

- if the call originated from a peer with the preference 'connect\_on\_ported' enabled and the *Routing Number* is set, then the called party number is replaced by the routing number

- if the call originated from a peer with the preference 'connect\_on\_ported' disabled, then the Sipwise C5 replies back with a '410 Ported' response. See [here](#) how to customize the '410 ported' response.
- if the call originated from a local subscriber with the preference 'connect\_on\_ported' enabled and the *Routing Number* is set, then the called party number is replaced by the routing number otherwise the call proceeds with other change.

If, after routing the call to a peer, the Sipwise C5 receive a '410 Ported' response back, then the LNP lookup logic is engaged using the called number for the query. In the case an LNP number entry is found and the *Routing Number* is set, then the called party number is replaced by the routing number, and the call is routed to the final destination. See [here](#) how to customize the '410 ported' response.

In case an online local subscriber with 'ported\_n1\_to\_ruri' preference enabled is called, then the LNP lookup logic is engaged trying to find a correspondence of the called number in the Routing Number list. In the case an entry is found, then the call is routed to the subscriber replacing the called party number with LNP number entry. After a first route attempt, if the local subscriber replies with a '404 Not Found' message, the Sipwise C5 does another attempt to route the call to the same subscriber, this time using the originally dialed number (Routing Number).

Similarly, when a local subscriber with 'ported\_n1\_to\_ruri' preference enabled makes a call, the LNP lookup logic is engaged trying to find a correspondence of the provided caller id number in the Routing Number list. In the case an entry is found, then the caller id number is replaced with the LNP number entry.

For example, the number 123456789 has been ported to 987654321. The Sipwise C5, as receiving operator, has a local subscriber with primary number 987654321 and an LNP entry with number '123456789' and routing number '987654321'. If a call comes in with callee number 987654321, the local subscriber is matched, but then the call is routed to the destination with the callee number 123456789. Similarly, when the same subscriber makes a call, the caller id 123456789 is accepted if the subscriber is recognised as a ported number and, prior to routing out the call, the caller id number is converted to 987654321.

#### 410 Ported response customization

The default response generated to or expected from a peer to inform that an operator does no longer possesses the number is '410 Ported'. Since the return code and reason could be different per country, two parameters in the config.yml file allow to change the default settings:

- `kamailio->proxy->lnp->local_qor->release_code` : it allows to define the return code
- `kamailio->proxy->lnp->local_qor->release_reason` : it allows to define the return reason

#### QoR LNP number manipulation

To simplify the QoR LNP lookup operation in the local database some number transformations can be configured in the config.yml file:

- `kamailio->proxy->lnp->local_qor->prefix_add_regex` : it specifies the regex query used to detect if the international prefix should be added to the number. For example: `^(6[0-9][7])$`.
- `kamailio->proxy->lnp->local_qor->prefix_remove_regex` : it specifies the regex query used to detect if the international prefix should be removed from the number. For example: `^(65[3-9][0-9][7])$`.
- `kamailio->proxy->lnp->local_qor->international_prefix` : it defines the international prefix to

add/remove to/from the lnp numbers. For example: '65'.

### Upload and Download LNP entries

The LNP database can be downloaded as CSV, and in the same format can be uploaded to the system. On upload, you can decide whether to drop existing data prior to applying the data from the CSV.

The CSV file format contains the fields in the following order:

Table 12. LNP CSV Format

Name	Description
Carrier Name	The <i>Name</i> in the LNP Carriers table (string, e.g. <i>My Carrier</i> )
Carrier Prefix	The <i>Prefix</i> in the LNP Carriers table (string, e.g. <i>DD55</i> )
Number	The <i>Number</i> in the LNP Numbers table (E164 number, e.g. <i>1800666</i> )
Routing Number	The <i>Routing Number</i> in the LNP Numbers table (E164 number or empty, e.g. <i>1555666</i> )
Start	The <i>Start</i> in the LNP Numbers table (YYYY-MM-DD or empty, e.g. <i>2016-01-01</i> )
End	The <i>End</i> in the LNP Numbers table (YYYY-MM-DD or empty, e.g. <i>2016-12-30</i> )
Authoritative	The <i>Authoritative</i> flag in the LNP Carriers table (0 or 1)
Skip Rewrite	The <i>Skip Rewrite</i> flag in the LNP Carriers table (0 or 1)
Type	The <i>Type</i> tag in the LNP Numbers table (alphanumeric string, e.g. <i>mobile</i> )

### LNP Dataset Importer

Large LNP datasets can be imported from CLI:

```
/usr/sbin/ngcp-lnp-importer
```

The importer uses a dedicated SQLite database file to identify the delta of LNP dataset files provided between (daily) runs, which is populated and processed in 3 separate stages:

1. import LNP dataset text file to SQLite database and identify delta
2. process *ADDED* delta: new LNP number (and carrier) records are created in the NGCP database tables
3. process *DELETED* delta: removed LNP number (and carrier) records are deleted in the NGCP database tables

The implementation is based on a multithread streaming processor design. In contrast to panel CSV upload/download, there will be a constant memory consumption when reading a LNP dataset file (regardless it's size).

**NOTE**

LNP dataset files are line-delimited (utf-8) text files with tens of millions of lines. A line will correspond to a LNP number or range of LNP numbers. The importer configuration allows to specify any custom file format implementation.

The importer is based on the *bulk-processor* ETL framework, which allows to configure database connectivity and working directories on your own. To start with, copy `/usr/share/perl5/NGCP/BulkProcessor/Projects/ETL/Lnp/config.cfg` to `/var/myworkspace/lnp/config.cfg` and adjust it accordingly:

```
##general settings:
working_path = /var/myworkspace/lnp
cpucount = 4
enablemultithreading = 1

##load credentials from constants.yml (requires root privileges):
constants_yml = /etc/ngcp-config/constants.yml

##gearman/service listener config:
#jobservers = 127.0.0.1:4730

##NGCP MySQL connectivity - "accounting" db:
#accounting_host = db01
#accounting_port = 3306
#accounting_databasename = accounting
#accounting_username = root
#accounting_password =

##NGCP MySQL connectivity - "billing" db:
#billing_host = db01
#billing_port = 3306
#billing_databasename = billing
#billing_username = root
#billing_password =

##NGCP MySQL connectivity - "provisioning" db:
#provisioning_host = db01
#provisioning_port = 3306
#provisioning_databasename = provisioning
#provisioning_username = root
#provisioning_password =

##NGCP MySQL connectivity - "kamailio" db:
#kamailio_host = db01
#kamailio_port = 3306
#kamailio_databasename = kamailio
#kamailio_username = root
#kamailio_password =
```

```

##NGCP MySQL connectivity - default db for distributed transactions (XA)
to connect to:
#xa_host = db01
#xa_port = 3306
#xa_databasename = ngcp
#xa_username = root
#xa_password =

##NGCP REST-API connectivity:
#ngcprestapi_uri = https://127.0.0.1:1443
#ngcprestapi_username = administrator
#ngcprestapi_password = administrator
#ngcprestapi_realm = api_admin_http

##sending email:
emailenable = 0
erroremailrecipient =
warnemailrecipient =
completionemailrecipient = jdoe@company.com
doneemailrecipient =

##logging:
#fileloglevel = DEBUG
fileloglevel = INFO
screenloglevel = INFO
emailloglevel = OFF

```

**NOTE**

Default values apply if not specified explicitly. When you ie. omit explicit connection details in `config.cfg`, credentials will be read from `/etc/ngcp-config/constants.yml`. This however requires to run the importer as unix user with elevated privileges.

Next, copy the importer configuration to `/usr/share/perl5/NGCP/BulkProcessor/Projects/ETL/Lnp/settings.yml` to `/var/myworkspace/lnp/settings.yml` and adjust it to your needs:

```

##CLI option to make changes to NGCP database permanent, or "dry run"
only:
#dry=0

##CLI option to abort run on errors:
#skip_errors=0

##LNP dataset file name (if not specified as CLI arg):
#lnp_filename: /var/myworkspace/lnp/input/large_lnp_dataset.txt
##line number (1-based) to start reading from:
lnp_rownum_start: 2

##SQLite database file to identify delta between runs -
/var/myworkspace/lnp/db/lnp.db
sqlite_db_file: lnp

```

```

##use multiple threads for loading lnp_filename to lnp.db:
import_multithreading: 1
##limit thread count:
lnp_import_numofthreads: 2
##insert multiple LNP numbers per transaction:
lnp_import_single_row_txn: 0
ignore_lnp_unique: 0

##use multiple threads for adding LNP number records to NGCP database:
create_lnp_multithreading: 1
##limit thread count:
create_lnp_numofthreads: 1
##insert multiple LNP numbers per transaction:
create_lnp_blocksize: 1000000
lnp_numbers_multi_insert: 1
lnp_numbers_single_row_txn: 0
ignore_lnp_numbers_unique: 0

##use multiple threads for removing LNP number records from NGCP
database:
delete_lnp_multithreading: 1
##limit thread count:
delete_lnp_numofthreads: 1
##delete multiple LNP numbers per transaction:
delete_lnp_blocksize: 1000
lnp_numbers_batch_delete: 1

##file format implementation
expand_numbers: !!perl/code |
    {
        my ($context,$row) = @_;
        my ($carrier_name,
            $carrier_prefix,
            $number,
            $routing_number,
            $start,
            $end,
            $authoritative,
            $skip_rewrite,
            $type) = split(/,/, $row);

        my @lnp_numbers = ();
        push(@lnp_numbers,[
            $carrier_name,
            $carrier_prefix,
            $number,
            $routing_number,
            (length($start) ? $start : undef),
            (length($end) ? $end : undef),
            $authoritative,
            $skip_rewrite,

```

```

    $type]) if length($row);
    return \@lnp_numbers;
}

```

By default, the LNP dataset file is considered as CSV with the known fields:

- carrier\_name
- carrier\_prefix
- number
- routing\_number
- start
- end
- authoritative
- skip\_rewrite
- type

Any custom file format implementation can be provided in `settings.yml`:

```

##the custom file format implementation is provided as a perl sub.
##the line string is passed as input argument, to be processed/split
as desired.
##the sub is supposed to return an array of LNP number records for NGCP,
##each of which is a array of the LNP number fields:
##[
##  'carrier_name',
##  'carrier_prefix',
##  'number',
##  'routing_number',
##  'start',
##  'end',
##  'authoritative',
##  'skip_rewrite',
##  'type',
##]
##these will also be the expected comma-separated fields,
##if no custom format is specified.
##below shows an example of a real-world file format implementation with
##number range expansion:
expand_numbers: !!perl/code |
  {
    my ($context,$row) = @_;
    if ($row =~ /^Linha\d+=[^=]*$/i) {
      my (
        $DonorID,
        $HolderID,
        $TypeOfNumber,
        $PABXMainTelephoneNumber,

```

```

    $FirstTelephoneNumber,
    $LastTelephoneNumber,
    $PresentNRN,
    $DateTimeFrom
  ) = split(/,/, $1);

  my @lnp_numbers = ();
  #020,012,0,212879000,212879000,212879999,D012001,2016-08-31
14:20:18
  unless ($PresentNRN =~ /^D012[0-9]{3,3}$/) { #custom number
range notation
    foreach my $number ($FirstTelephoneNumber ..
$LastTelephoneNumber) {
      push(@lnp_numbers, [
        $PresentNRN, #'carrier_name',
        $PresentNRN, #'carrier_prefix',
        $number, #'number',
        undef, #'routing_number',
        $DateTimeFrom, #'start',
        undef, #'end',
        undef, #'authoritative',
        undef, #'skip_rewrite',
        undef, #'type',
      ]);
    }
  }
  return \@lnp_numbers;
}

return [];
}

```

The importer stages can be invoked using the `--task` options:

#### Load LNP dataset file:

```

sudo ngcp-lnp-importer \
  --task=load_file
  --config=/var/myworkspace/lnp/config.cfg
  --settings=/var/myworkspace/lnp/settings.yml
  --file=/var/myworkspace/lnp/input/large_lnp_dataset.txt

```

#### Purge all LNP records in NGCP:

```

sudo ngcp-lnp-importer \
  --task=purge_lnp
  --config=/var/myworkspace/lnp/config.cfg
  --settings=/var/myworkspace/lnp/settings.yml

```

**Create *ADDED* delta LNP records in NGCP:**

```
sudo ngcp-lnp-importer \
  --task=create_lnp
  --config=/var/myworkspace/lnp/config.cfg
  --settings=/var/myworkspace/lnp/settings.yml
```

**Delete *DELETED* delta LNP records in NGCP:**

```
sudo ngcp-lnp-importer \
  --task=delete_lnp
  --config=/var/myworkspace/lnp/config.cfg
  --settings=/var/myworkspace/lnp/settings.yml
```

**Load LNP dataset file, create and delete LNP records in NGCP *in one go*:**

```
sudo ngcp-lnp-importer \
  --task=load_file
  --task=create_lnp
  --task=delete_lnp
  --config=/var/myworkspace/lnp/config.cfg
  --settings=/var/myworkspace/lnp/settings.yml
  --file=/var/myworkspace/lnp/input/large_lnp_dataset.txt
```

**NOTE**

The `--dry` option switch will simulate manipulating records of the NGCP database, without making permanent changes. This allows to test if e.g. unique constraints are violated by the dataset.

**Reset SQLite database:**

```
sudo ngcp-lnp-importer \
  --task=cleanup
  --config=/var/myworkspace/lnp/config.cfg
  --settings=/var/myworkspace/lnp/settings.yml
```

**IMPORTANT**

The SQLite database holds the delta information. The NGCP LNP records should be empty/purged before any initial import (without delta).

**NOTE**

The SQLite `.db` database file can be easily copied to save/restore delta information.

**Local LNP returned values**

If a match in the local LNP table is found corresponding LNP Carrier code will be stored in CDR data.

Additionally two dedicated headers can be added to the outgoing SIP message:

- P-NGCP-LNP-Number: The returned LNP number, if any

- P-NGCP-LNP-Status: The LNP query return code (200 if successful, 404 if no entry found)

This feature is not enabled by default, but can be activated with the following parameters:

- kamailio->proxy->lnp->add\_reply\_headers->enable : *no*
- kamailio->proxy->lnp->add\_reply\_headers->number : *P-NGCP-LNP-Number*
- kamailio->proxy->lnp->add\_reply\_headers->status : *P-NGCP-LNP-Status*

## 7.6.2. External LNP via LNP API

External LNP relies on the *NGCP LNP Daemon (ngcp-lnpd)* which kamailio-proxy is talking to via a defined JSONRPC protocol. The proxy sends the A and B number to *ngcp-lnpd*, which translates it to a SIP INVITE message sent to an external server. *ngcp-lnpd* supports at the moment 2 different types of redirection servers:

- Squire SIP-to-INAP gateway: it performs an SS7 INAP request to fetch the LNP result, which is passed back as a binary blob in a 3xx response to *ngcp-lnpd*. *ngcp-lnpd* extracts the TCAP body of the response and returns the information back to the proxy.
- Plain 302 Redirecting: it performs an internal lookup to fetch the LNP result, which is passed back as SIP headers in a 3xx response to *ngcp-lnpd*. *ngcp-lnpd* extracts the redirecting number from the username of the Contact header and the LNP code from the X-LNP header (the name is configurable), and then returns this information back to the proxy.

### Enabling LNP lookup via API

In order to activate LNP lookup via API during call routing, the feature must be activated in `/etc/ngcp-config/config.yml`. Set these parameters:

- kamailio->proxy->lnp->enable : *yes*
- kamailio->proxy->lnp->type : *api*
- lnpd->enable : *yes*

There is a possibility to explicitly allow (whitelist) or deny (blacklist) certain number ranges for which an LNP lookup may be done. The relevant configuration parameters are at `kamailio->proxy->lnp->lnp_request_whitelist` and `kamailio->proxy->lnp->lnp_request_blacklist`. For each entry in the list a POSIX regex expression may be used, see the following example:

```
lnp:
  lnp_request_whitelist:
    - '^9'
    - '^800'
  lnp_request_blacklist:
    - '^1'
    - '^900'
    - '^110'
    - '^112'
```

Interpretation of the above lists (that are based on numbers represented in national format):

- whitelist: *do* LNP lookup for any called number that starts with '9' or '800'
- blacklist: *do not* perform LNP lookup for any called number that starts with '1', '900', '110' or '112'

**IMPORTANT**

If both whitelist and blacklist are defined, the LNP lookup is only performed when the called number matches any of the whitelist patterns and does not match any of the blacklist patterns.

**Squire SIP-to-INAP gateway: Refine LNP and FCI decoding**

Preconfigured parameters for Squire SIP-to-INAP gateway method should already make it possible to correctly decode the LNP number and FCI code contained in the received TCAP body. If the external server replies with a non-standard TCAP body, it is possible to fine tune the information extraction. Edit the following parameters in order to point to the correct fields:

- kamilio->proxy->lnp->api->tcap\_field\_lnp : *ConnectArg.destinationRoutingAddress.0*
- kamilio->proxy->lnp->api->tcap\_field\_opcode : *end.components.0.invoke.opCode*
- kamilio->proxy->lnp->api->tcap\_field\_fci : *end.components.0.invoke.parameter*

**Plain 302 Redirecting: Refine LNP and FCI decoding**

A preconfigured setup to connect to a plain 302 redirecting server is already deployed on the system and only has to be activated. In case you need to change the name of the header that will return the LNP code, please check [Configuration of LNP daemon](#).

**The Redundancy Feature**

It is possible to set up *LNP daemon* to provide a kind of redundant service to the Proxy. This means the *LNP daemon* will send its LNP query to more LNP serving nodes that are predefined in a list. (See [Configuration of LNP daemon](#) chapter for details.) The LNP query may happen in 2 ways:

- **round-robin:** *LNP daemon* sends the query to one of the serving nodes then waits for the response for a configurable timeout. If it does not get the response in time, it sends the LNP query to the next serving node.
- **parallel:** *LNP daemon* sends the query to all of the serving nodes then waits for the response, and will accept the first response that it receives.

**Configuration of Sipwise LNP Daemon**

*LNP daemon* takes its active configuration from `/etc/ngcp-lnpd/config.yml` file. The file is generated automatically—when a new Sipwise C5 configuration is applied (`ngcpcfg apply...`)—from the main Sipwise C5 configuration file: `/etc/ngcp-config/config.yml` and a template: `/etc/ngcp-config/template/etc/ngcp-lnpd/config.yml.tt2`. System administrators are only expected to modify the `lnpd.config` section of main configuration file `/etc/ngcp-config/config.yml`.

A sample *LNP daemon* configuration file (`/etc/ngcp-lnpd/config.yml`) looks like:

```
daemon:
  json-rpc:
    ports:
      - 54321
```

```
        - 12345
    interfaces:
        - 127.0.0.1
        - 192.168.1.90
        - ::1

    sip:
        port: 5095
        address: 0.0.0.0

    threads: 4
    foreground: false
    pidfile: /run/ngcp-lnpd.pid
    loglevel: 6

instances:
    default_sigtran:
        module: sigtran
        destination: 192.168.1.99
        from-domain: test.example.com
        headers:
            - header: INAP-Service-Key
              value: 2
        reply:
            tcap: raw-tcap
    redundant:
        module: sigtran
        destinations:
            - 192.168.1.99
            - 192.168.1.95
            - 192.168.1.90
        mechanism: round-robin
        retry-time: 30
        timeout: 5
        from-domain: test.example.com
        headers:
            - header: INAP-Service-Key
              value: 2
        reply:
            tcap: raw-tcap
    parallel:
        module: sigtran
        destinations:
            - 192.168.1.99
            - 192.168.1.95
            - 192.168.1.90
        mechanism: parallel
        retry-time: 30
        timeout: 10
        from-domain: test.example.com
        headers:
            - header: INAP-Service-Key
```

```

        value: 2
      reply:
        tcap: raw-tcap
mock1:
  module: mock-tcap
  numbers:
    - number: '4311003'
      routing-number: '4318881003'
  reply:
    tcap: raw-tcap
default_sipredir:
  module: sipredir
  destination: 192.168.1.1:8888
  from-domain: test.example.com
  headers: []
  reply:
    user: username
    dom: domain
    code: portability
  reply-headers:
    - header: X-LNP
      map-to: portability

```

The corresponding Sipwise C5 main configuration file contains:

```

daemon:
  foreground: 'false'
  json_rpc:
    ports:
      - '54321'
      - '12345'
  loglevel: '6'
  sip:
    port: '5095'
    threads: '4'
  instances:
    << These are the same entries as in /etc/ngcp-lnpd/config.yml file
    >>

```

### Description of configuration parameters in /etc/ngcp-config/config.yml file

- daemon section:

foreground: determines if the LNP daemon runs as foreground or background process

json\_rpc.ports: port numbers where LNP daemon listens for incoming JSONRPC requests from Sipwise C5 Proxy

loglevel: how detailed information LNP daemon writes in its log file

sip.port: listening port number used for SIP sessions with LNP serving nodes; LNP daemon will listen on first available (shared) *sip\_int* IP address that is taken from /etc/ngcp-

config/network.yml file

threads: number of threads LNP daemon will use internally; this value determines how many requests the daemon can serve in parallel

- instances section: at least one **default** instance must be defined here. Others are also useful for providing redundancy, please check **redundant** and **parallel** entries above.

module: either **sigtran** or **sipredir** depending on the type of external server

### IMPORTANT

The module **mock-tcap** is only meant for developers. In this case the LNP daemon does not produce a SIP request that it sends to LNP serving nodes, but instead it uses the **numbers** parameter to match a called number with a routing number. The **numbers** parameter contains a list of number—routing-number pairs and is used as a database for number lookups. Finally LNP daemon returns the routing number as a response on LNP query.

destinations: list of nodes to which LNP daemon sends the LNP query

mechanism: either **parallel** or **round-robin**, defining the method of redundant queries

retry-time: a period of time in seconds while LNP daemon considers an LNP serving node being unreachable after an LNP query timeout

timeout: the period of time while LNP daemon waits for a response on an LNP query from one of the LNP serving nodes

### NOTE

**retry-time** and **timeout** are used with both the parallel and the round-robin redundancy methods

from-domain: the domain that will be used in SIP *From* header when LNP daemon sends the LNP query

headers: this is a list of **header** name—**value** pairs; these custom headers will be included in SIP request that LNP daemon sends to an LNP serving node. Necessary only when **sigtran** module is used.

reply: determines the json keys and values returned to Sipwise C5 Proxy.

tcap: currently only **raw-tcap** is supported, which means LNP daemon will not decode the TCAP response it gets from an LNP serving node but forwards the raw TCAP message body. Only for **sigtran** module.

user: username extracted from the Contact header. Only for **sipredir** module.

dom: domain extracted from the Contact header. Only for **sipredir** module.

code: LNP portability code extracted from the custom header. Only for **sipredir** module.

**reply-headers**: this is a list of **header** name—**map-to** pairs; these custom headers will be read by LNP daemon from the 302 reply message and internally translated into a variable that can be used in the **reply** parameter to return values Sipwise C5 Proxy. At least the header that provides the portability information has to be defined (X-LNP by default). Necessary only when **sipredir** module is used.

## Selection of Sipwise LNP Daemon Instances

By default the instance with name **default** is used for all the lnp queries. To dynamically select which instance use, or to completely skip the lnp query for a particular call, the lnp api module is looking into

the SIP message for the header with name *P-NGCP-Lnpd\_Instance*:

- if present and not empty, the instance with the name equal to the header content is used
- if present but empty, the lnp api lookup is skipped
- if not present, the **default** instance is used

### LNP API number manipulation

The country code assigned to the calling subscriber can be prepended to the redirecting number obtained from the LNP lookup. To enable this feature please set the following parameter:

- `kamailio->proxy->lnp->api->add_caller_cc_to_lnp_dst : no`

The obtained result can be also rewritten using dedicated LNP Rewrite Rules for Callee. The rewrite rule set used is the one assigned to the originating peer or subscriber/domain via the `rewrite_rule_set` preference. This variable is available in the match and replace part, beside the standard variables for rewrite rules:

- `${callee_lnp_prefix}`: lnp redirecting code

This feature is not enabled by default, but can be activated with the following parameters:

- `kamailio->proxy->lnp->api->apply_callee_lnp_rewrite : no`

### LNP API returned values

As for Local LNP, the LNP number and the FCI code are stored in CDR data.

Additionally two dedicated headers can be added to the outgoing SIP message:

- `P-NGCP-LNP-Number`: The returned LNP number, if any
- `P-NGCP-LNP-Status`: The LNP query return code (200 if successful, 404 if no entry found, 408 in case of connection timeout or 500 if another general error happens)

This feature is not enabled by default, but can be activated with the following parameters:

- `kamailio->proxy->lnp->add_reply_headers->enable : no`
- `kamailio->proxy->lnp->add_reply_headers->number : P-NGCP-LNP-Number`
- `kamailio->proxy->lnp->add_reply_headers->status : P-NGCP-LNP-Status`

### LNP API advanced setup

Sipwise `C5 config.yml` provides some advanced configuration to control what happens to the call based on whether the LNP lookup is completed successfully or not (timeout, malformed or missing data in the message):

- `kamailio->proxy->lnp->api->check_if_user_is_local_after_succ_lookup : no`. By default in case of successful LNP lookup, the system assumes that the callee is reachable via a peer connection. Set this option to **yes** instead to force the system to check if the redirecting number belongs to a local subscriber.
- `kamailio->proxy->lnp->api->check_if_user_is_local_after_fail_lookup : no`. By default in case of failed

LNP lookup, the system tries to reach the callee using the originally dialed number via a peer connection. Set this option to **yes** instead to force the system to check if the originally number belongs to a local subscriber.

- `kamailio->proxy->lnp->api->reply_error_on_lnp_failure` : *no*. If set to **yes** it will return a SIP error message back to the caller in case of failed LNP lookup.

## 7.7. P-Early-Media

The Sipwise C5 platform supports P-Early-Media Sip Header according to RFC5009.

### 7.7.1. Implementation

The Sipwise C5 platform tries to find a P-Early-Media SIP header on every INVITE message coming from peers or subscribers. If the header is found, it tries to parse the content, in particular it looks for the following parameters:

- `sendonly`
- `recvonly`
- `inactive`
- `sendrecv`
- `supported`
- `gated`

Any other parameter found will be silently discarded.

The first four parameters are also known as *directional parameters* and they will influence how the Sipwise C5 platform will behave when a service, potentially producing early media, is involved during the call. The P-Early-media header will be also transparently sent to the b leg of the call and to the callee which must honour the contents of the header before playing early media.

A typical example is when a subscriber with an announce preference activated is called, under normal conditions the early media with the announce is played before connecting to the callee. The early media however won't be played if the caller is not willing to receive the early audio stream (*inactive* and *sendonly* directional parameters set in P-Early-Media).

There are cases when Sipwise C5 produces an early media to alert the user of an error (typical examples are when the callee is offline or pstn termination is not available). In this situations, if the caller is not willing to receive the early audio stream, Sipwise C5 will just return a SIP error without playing the early media announce.

The presence of the *supported* parameter forces the Sipwise C5 platform to send back P-Early-Media in 18X replies even if the callee user agent does not include it. This will help the caller user agent to understand that we are going to send early media and an audio channel must be allocated and opened. The Sipwise C5 platform will add the missing P-Early-Media back from the callee towards the caller, according to the following schema:

- if caller sends P-Early-Media: **sendonly** Sipwise C5 will reply with P-Early-Media: **recvonly**
- if caller sends P-Early-Media: **recvonly** Sipwise C5 will reply with P-Early-Media: **sendonly**

- if caller sends P-Early-Media: **sendrecv** Sipwise C5 will reply with P-Early-Media: **sendrecv**
- if caller sends P-Early-Media: **inactive** Sipwise C5 will reply with P-Early-Media: **inactive**

The *gated* parameter is recognized by Sipwise C5 but it doesn't affect its mode of operation. This parameter, if present, is just passed transparently to the callee.

### 7.7.2. Configuration

It's possible to alter how Sipwise C5 manages P-Early-Media just changing the following parameters inside the *config.yml* file:

- `kamailio.proxy.p_early_media.default_auth`: this parameter will instruct how Sipwise C5 behaves when a P-Early-Media without directional parameters is received. The default behaviour will permit early media streams on both directions (`sendrecv`).
- `kamailio.proxy.p_early_media.play_on_missing`: this parameter will drive the Sipwise C5 behaviour when the caller sends an INVITE message without P-Early-Media header. If set to `yes` (default), Sipwise C5 will be allowed to play early media for its own services. If set to `no` Sipwise C5 will skip early media since it's assuming the caller is not willing to receive early media.

## 7.8. Emergency Mapping

As opposed to the [Simple Emergency Number Handling](#) solution, Sipwise C5 supports an advanced emergency call handling method, called *emergency mapping*. The main idea is: instead of obtaining a statically assigned emergency prefix / suffix from subscriber preferences, Sipwise C5 retrieves an emergency routing prefix and suffix from a central emergency call routing table, according to the current location of the calling subscriber.

The following figure shows the overview of emergency call processing when using *emergency mapping* feature:

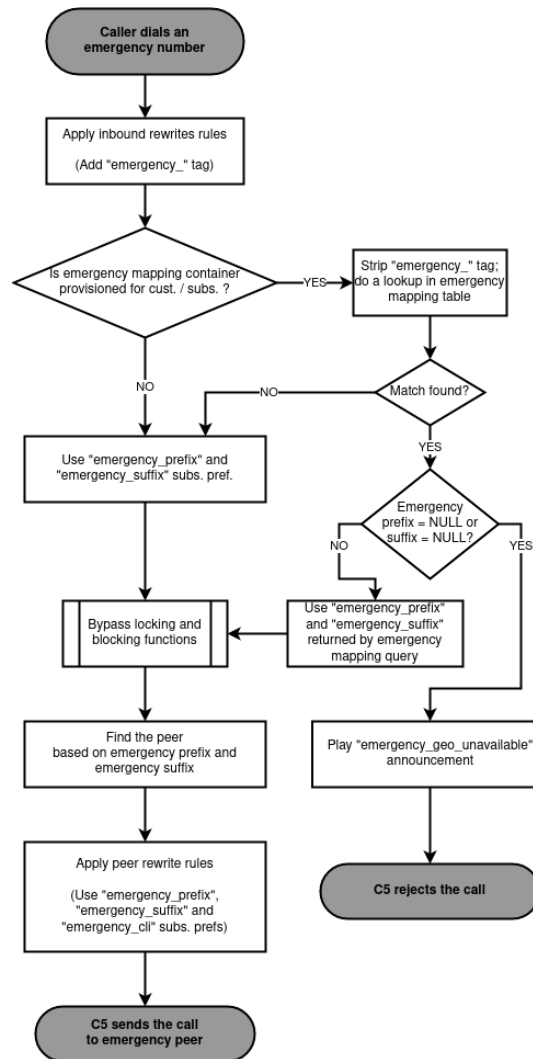

Figure 67. Emergency Call Handling with Mapping

### 7.8.1. Emergency Mapping Description

Emergency numbers per geographic location are mapped to different routing prefixes not derivable from an area code or the emergency number itself. In some cases the suffix is also needed to be added to the emergency number. This is why a **global emergency mapping table** related to resellers is introduced, allowing to map emergency numbers to their geographically dependent routing numbers.

The geographic location is referenced by a location ID, which has to be populated by a north-bound provisioning system. No towns, areas or similar location data is stored on Sipwise C5 platform. The locations are called *Emergency Containers* on NGCP.

The actual emergency number mapping is done per location (per *Emergency Container*), using the so-called *Emergency Mapping* entries. An *Emergency Mapping* entry assigns a routing prefix, valid only in a geographic area, to a generic emergency number (for example '112' in Europe, '911' in the U.S.A.) or a country specific one (for example '133').

#### NOTE

Sipwise C5 performs an exact match on the emergency number in the emergency routing table.

*Emergency Containers* may be assigned to various levels of the client hierarchy within NGCP. The

following list shows such levels with each level overriding the settings of the previous one:

1. Customer or Domain
2. Customer Location, which is a territory representing a subset of the customer's subscribers, defined as one or more IP subnets.
3. Subscriber

**NOTE**

Please be aware that *Customer Location* is not necessarily identical to the "location" identified through an *Emergency Container*.

Once the emergency routing prefix or suffix has been retrieved from the emergency mapping table, call processing continues in the same way as in case of simple emergency call handling.

## 7.8.2. Emergency Mapping Configuration

The administrative web panel of Sipwise C5 provides the configuration interface for emergency mapping. Please navigate to *Settings Emergency Mapping* menu item first, in order to start configuring the mapping.

An *Emergency Container* must be created, before the mapping entries can be defined. Press *Create Emergency Container* to start this. An example of a container is shown here:

The screenshot displays the 'Edit Emergency Containers' interface. At the top, there is a search bar labeled 'Reseller' and 'Search:'. Below it is a table with the following data:

#	Name	Contract #	Status	
1	default	1	active	<input checked="" type="checkbox"/>
3	api_test test reseller	137	active	<input type="checkbox"/>
5	patched name 1494894408	179	active	<input type="checkbox"/>
7	test reseller 1494894408 2	181	active	<input type="checkbox"/>
9	test reseller 1494894408 3	183	active	<input type="checkbox"/>

Below the table, it says 'Showing 1 to 4 of 8 entries' and includes navigation buttons (left, right, 1, 2). A 'Create Reseller' button is also present. At the bottom, there is a 'Name' input field with the value 'EmergCont\_1' and a 'Save' button.

Figure 68. Creating an Emergency Container

You have to select a Reseller that this container belongs to, and enter a Name for the container, which is an arbitrary text.

**TIP**

The platform administrator has to create as many containers as the number of different geographic areas (locations) the subscribers are expected to be in.

As the second step of emergency mapping provisioning, the *Emergency Mapping* entries must be created. Press *Create Emergency Mapping* to start this step. An example is shown here:

**Create Emergency Mappings** + x

Emergency Mapping Container Search:

#	Reseller	Name	
5	default	EmergCont_2	<input type="checkbox"/>
1	default	test emergency container	<input type="checkbox"/>
3	default	EmergCont_1	<input checked="" type="checkbox"/>

Showing 1 to 3 of 3 entries

← 1 →

Create Emergency Mapping Container

Code

Prefix

Suffix

Save

Figure 69. Creating an Emergency Mapping Entry

The following parameters must be set:

- Container: select an emergency mapping container (i.e. a location ID)
- Code: the emergency number that subscribers will dial
- Prefix: the routing prefix that belongs to the particular emergency service within the selected location
- Suffix: the routing suffix that belongs to the particular emergency service within the selected location

Once all the necessary emergency mappings have been defined, the platform administrator will see a list of containers and mapping entries:

## Emergency Mappings

[← Back](#)
[★ Download CSV](#)
[★ Upload CSV](#)

### Emergency Containers

[★ Create Emergency Container](#)

Show  entries Search:

#	Reseller	Name
1	default	test emergency container
3	default	EmergCont_1
5	default	EmergCont_2

Showing 1 to 3 of 3 entries

### Emergency Mappings

[★ Create Emergency Mapping](#)

Emergency mapping successfully created

Show  entries Search:

#	Container	Reseller	Emergency Number	Emergency Prefix	Emergency Suffix
1	test emergency container	default	123	456	
3	EmergCont_1	default	133	E1_133_	_321
5	EmergCont_1	default	144	E1_144_	_321
7	EmergCont_2	default	133	E1_133_	_321

Showing 1 to 4 of 4 entries

Figure 70. Emergency Mapping List

The emergency number mapping is now defined. As the next step, the platform administrator has to assign the emergency containers to *Customers* / *Domains* / *Customer Locations* or *Subscribers*. We'll take an example with a *Customer*: select the customer, then navigate to *Details Preferences Number Manipulations*. In order to assign a container, press the *Edit* button and then select one container from the drop-down list:

### Customer #205 - Preferences

← Back
Expand Groups

Call Blockings

Access Restrictions

Number Manipulations

	Attribute	Name	Value	
i	emergency_prefix	Emergency Prefix variable		
i	emergency_suffix	Emergency Suffix variable		
i	emergency_cli	Emergency CLI		
i	emergency_mapping_container	Emergency Mapping Container	EmergCont_2	<span style="background-color: #e67e22; color: white; padding: 2px 5px; border-radius: 3px;">Edit</span>

Internals

Figure 71. Assigning an Emergency Mapping Container

### Rewrite Rules for Emergency Mapping

Once emergency containers and emergency mapping entries are defined, Sipwise C5 administrator has to ensure that the proper number manipulation takes place, before initiating any emergency call towards peers.

#### IMPORTANT

Please don't forget to define the rewrite rules for peers—particularly: *Outbound Rewrite Rules for Callee*—as described in [Normalize Emergency Calls for Peers](#) section of the handbook.

### Emergency Calls Not Allowed

There is a special case when the dialed number is recognized as an emergency number, but the emergency number is not available for the geographic area the calling party is located in.

In such a case the emergency mapping lookup will return an emergency prefix, but the value of this will be NULL. Therefore the call is rejected and an announcement is played. The announcement is a newly defined sound file referred as `emergency_geo_unavailable`.

It is possible to configure the rejection code and reason in `/etc/ngcp-config/config.yml` file, the parameters are: `kamailio.proxy.early_rejects.emergency_invalid.announce_code` and `kamailio.proxy.early_rejects.emergency_invalid.announce_reason`.

### Bulk Upload or Download of Emergency Mapping Entries

The Sipwise C5 offers the possibility to upload / download emergency mapping entries in form of CSV files. This operation is available for each reseller, and is very useful if a reseller has many mapping entries.

### Downloading Emergency Mapping List

One has to navigate to *Settings Emergency Mapping* menu and then press the *Download CSV* button to get the list of mapping entries in a CSV file. First the reseller must be selected, then the *Download* button must be pressed. As an example, the entries shown in "Emergency Mapping List" picture above would be written in the file like here below:

```
EmergCont_1,133,E1_133_,_321
EmergCont_1,144,E1_144_,_321
EmergCont_2,133,E2_133_,_321
```

The **CSV file** has a plain text format, each line representing a mapping entry, and contains the following **fields**:

- Container name, as defined in *Emergency Containers*
- Emergency Number
- Emergency Prefix
- Emergency Suffix

### **Uploading Emergency Mapping List**

Uploading a CSV file with emergency mapping entries may be started after pressing the *Upload CSV* button. The following data must be provided:

- Reseller: selected from the list
- Upload mapping: the CSV file must be selected after pressing the *Choose File* button
- Purge existing: an option to purge existing emergency mapping entries that belong to the selected reseller, before populating the new mapping data from the file

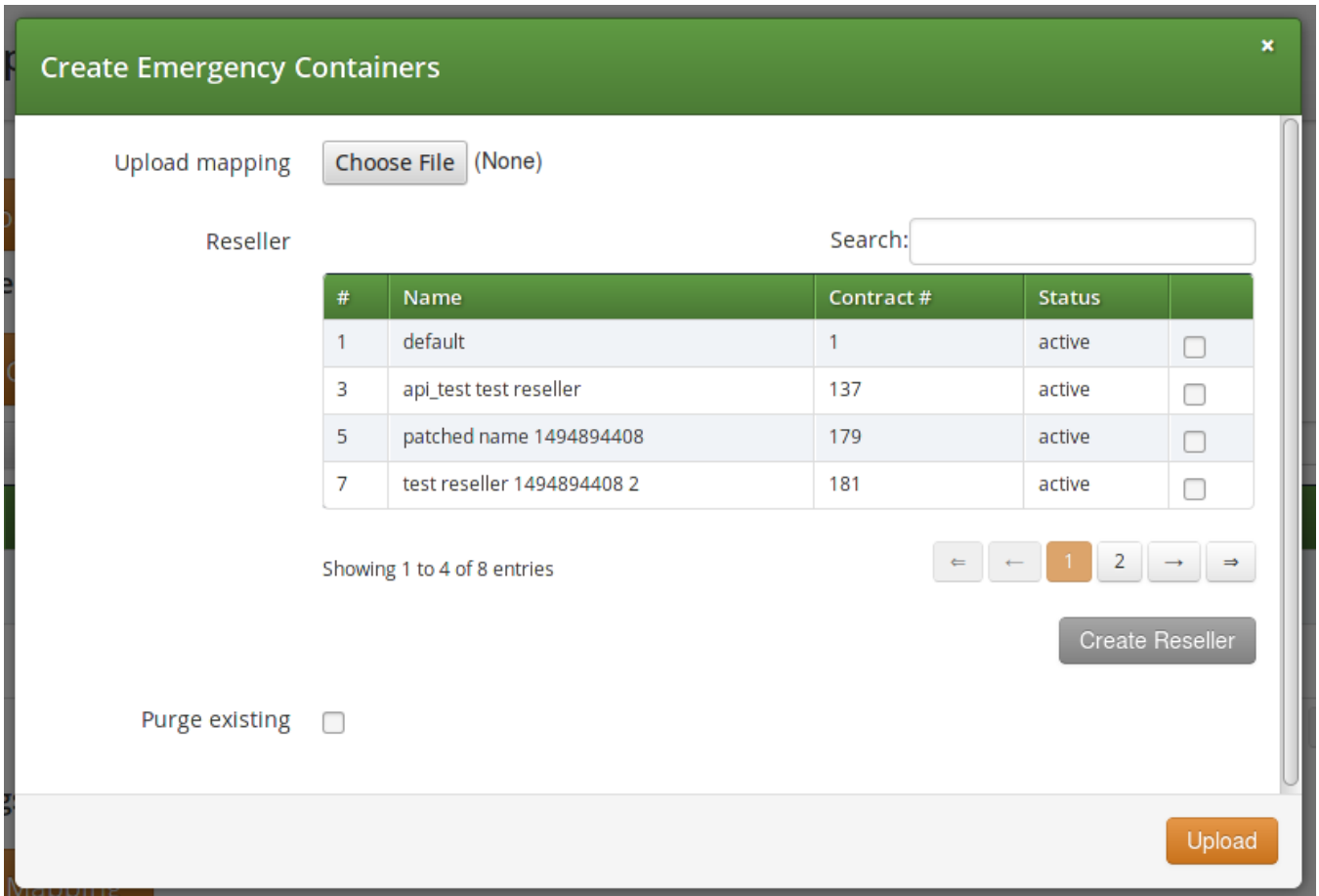

Figure 72. Uploading Emergency Mapping Data

The CSV file for the upload has the same format as the one used for download.

## 7.9. Emergency Prioritization

The Sipwise C5 can potentially host *privileged subscribers* that offer emergency or at least prioritized services (civil defence, police etc.). In case of an emergency, the platform has to be free'd from any SIP flows (calls, registrations, presence events etc.) which do not involve those privileged subscribers.

Such an exceptional condition is called **emergency mode** and it can be activated for all domains on the system, or only for selected domains.

Once emergency mode is activated, Sipwise C5 will immediately apply the following restrictions on new SIP requests or existing calls:

- Any SIP requests (calls, registrations etc.) from subscribers within the affected domains, who are not marked as privileged, are rejected.
- Any calls from peers not targeting privileged subscribers are rejected.
- Any active calls which do not have a privileged subscriber involved are terminated.

Calls from non-privileged subscribers to emergency numbers are still allowed.

### 7.9.1. Call-Flow with Emergency Mode Enabled

Typical call-flows of emergency mode will be shown in this section of the handbook. We have the following assumptions:

- Emergency prioritization has been enabled on system-level
- There is a domain for which the emergency mode has been activated
- There is a privileged subscriber in that domain
- A generic peering connection has been configured for non-emergency calls
- A dedicated peering connection has been configured for emergency calls

The examples do not show details of SIP messages, but rather give a high-level overview of the call-flows.

1. A **non-privileged** subscriber makes a call **to another non-privileged subscriber**. Result: the call will be **rejected**.

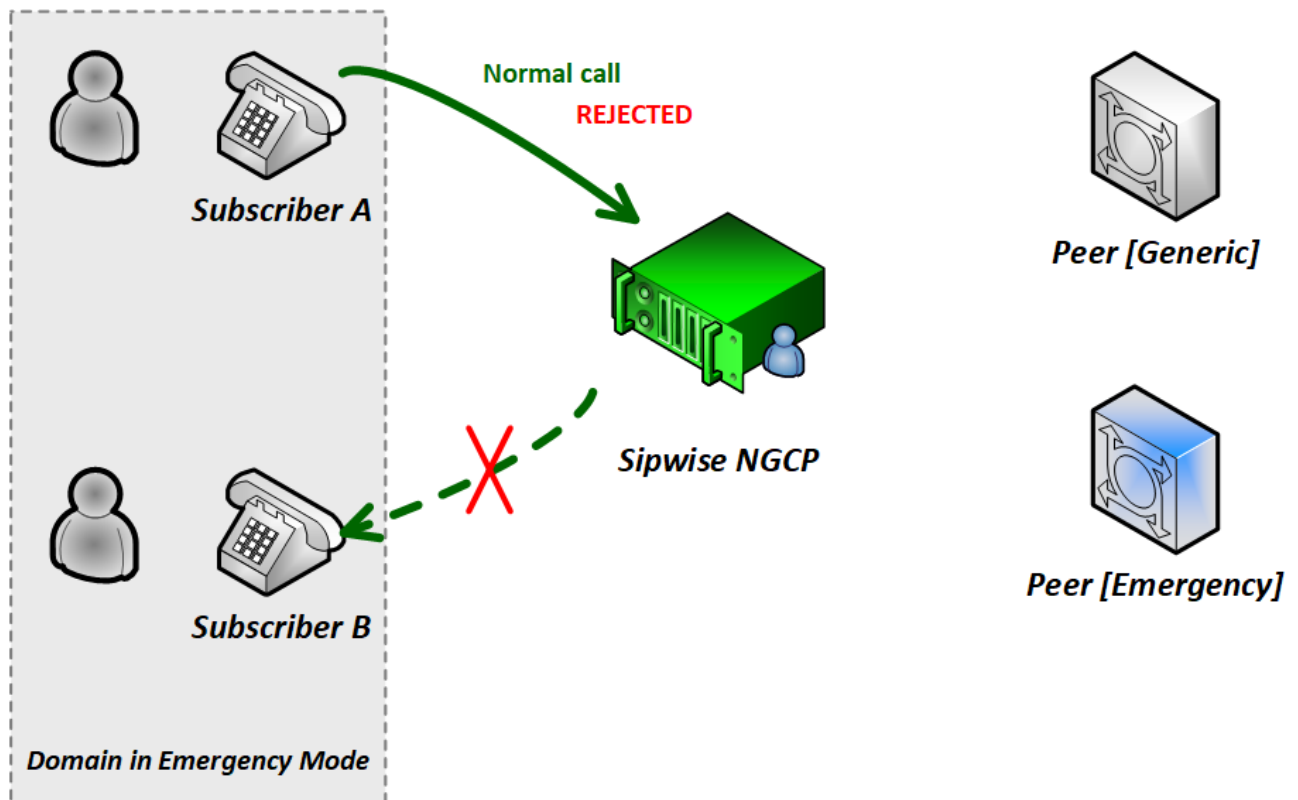

Figure 73. Call-flow in Emergency Mode 1. (Std to Std)

2. A **non-privileged** subscriber makes a call **to an external subscriber (via peer)**. Result: the call will be **rejected**.

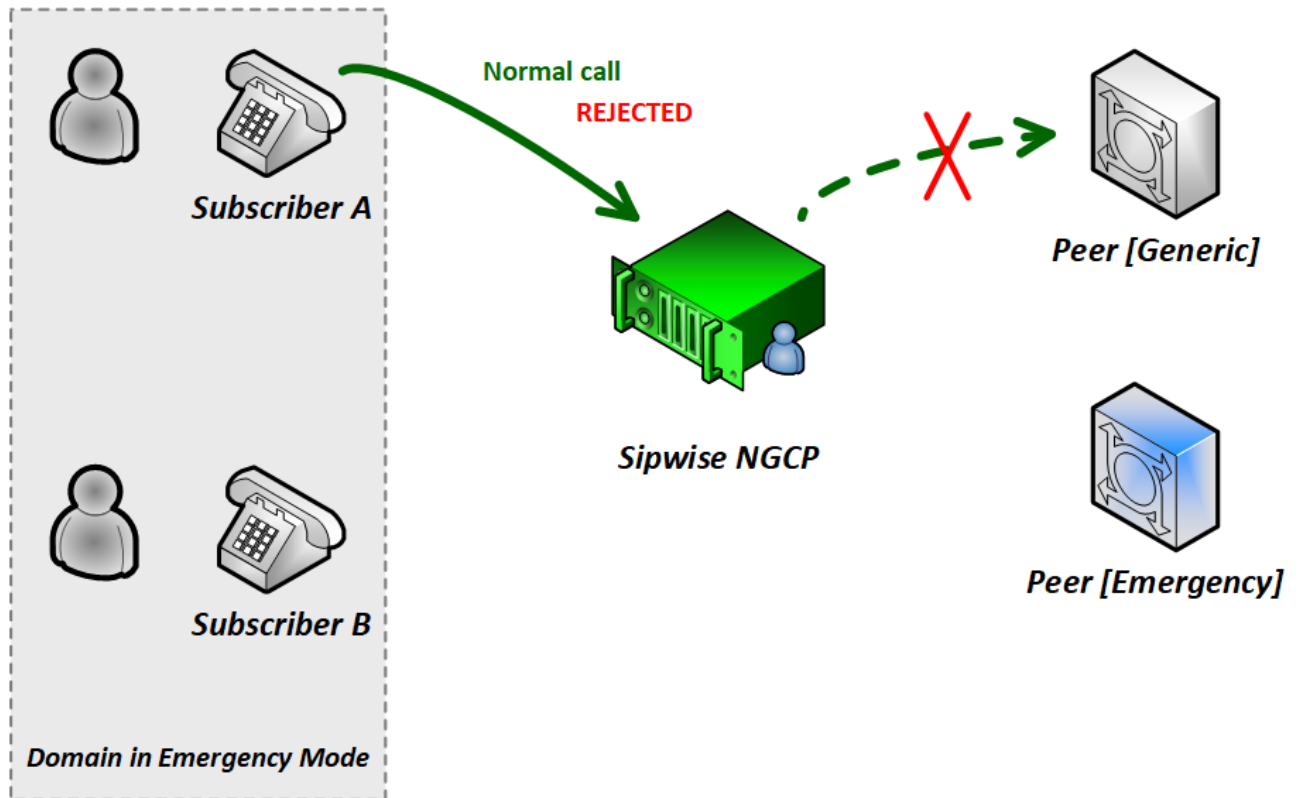

Figure 74. Call-flow in Emergency Mode 2. (Std to Peer)

3. A **non-privileged** subscriber makes a call **to a privileged subscriber**. Result: the call will be **accepted**.

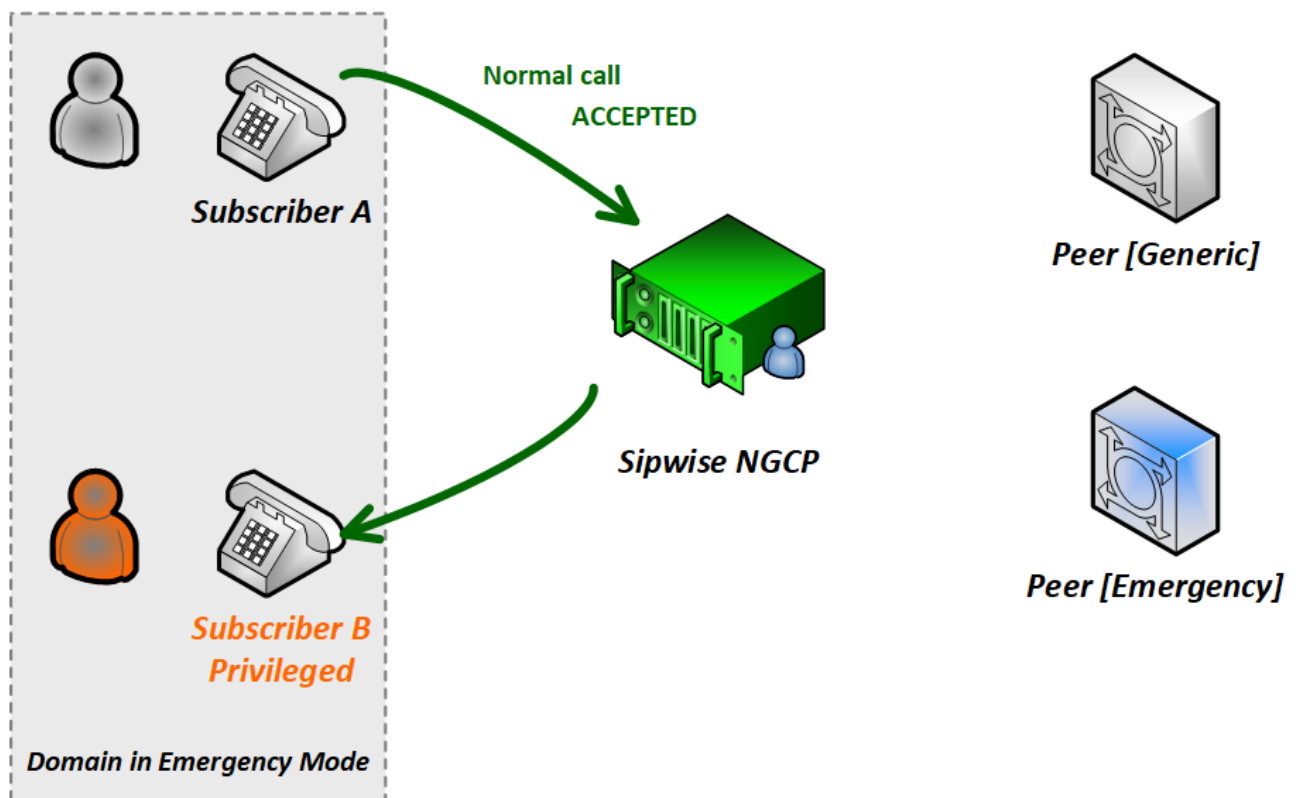

Figure 75. Call-flow in Emergency Mode 3. (Std to Priv)

4. A **non-privileged** subscriber makes a call **to an emergency number**. Result: the call will be **accepted**.

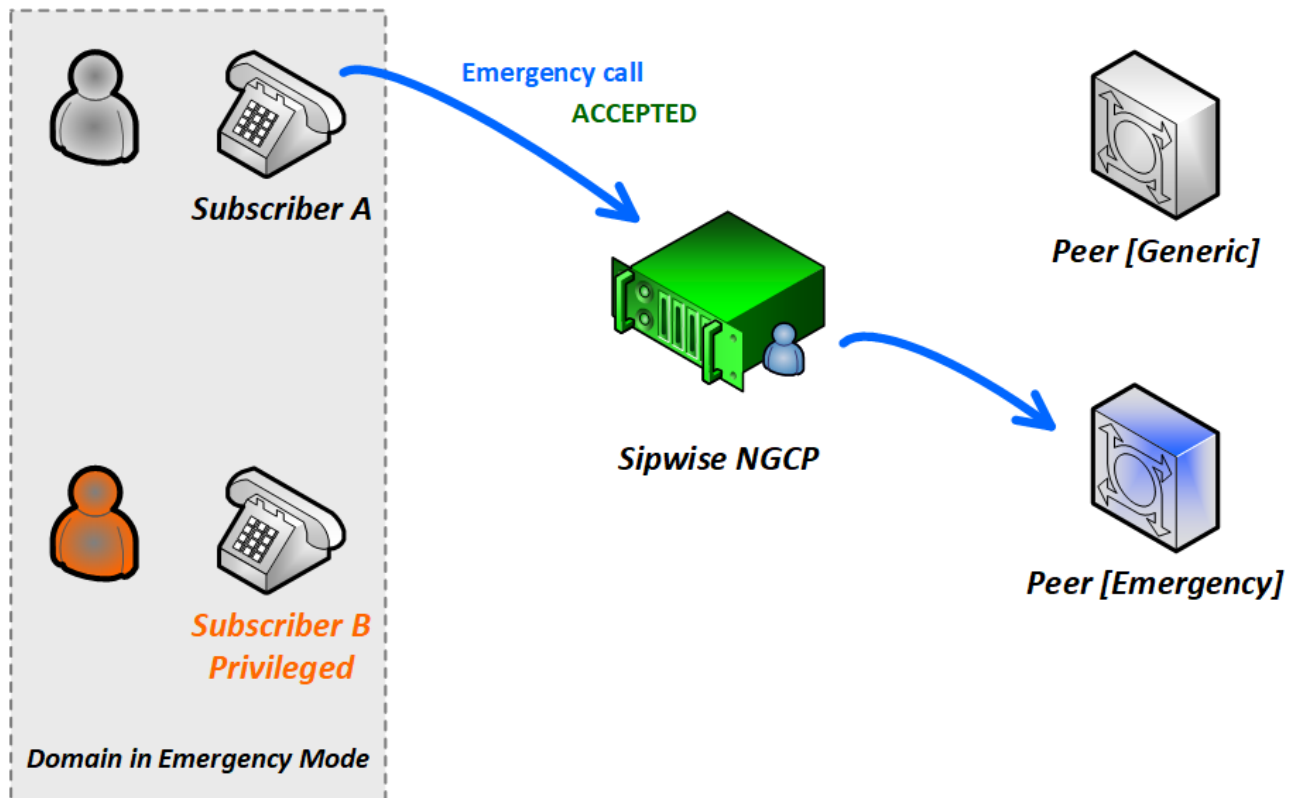

Figure 76. Call-flow in Emergency Mode 4. (Std to Emerg)

5. A **privileged** subscriber makes a call **to a non-privileged subscriber**. Result: the call will be **accepted**.

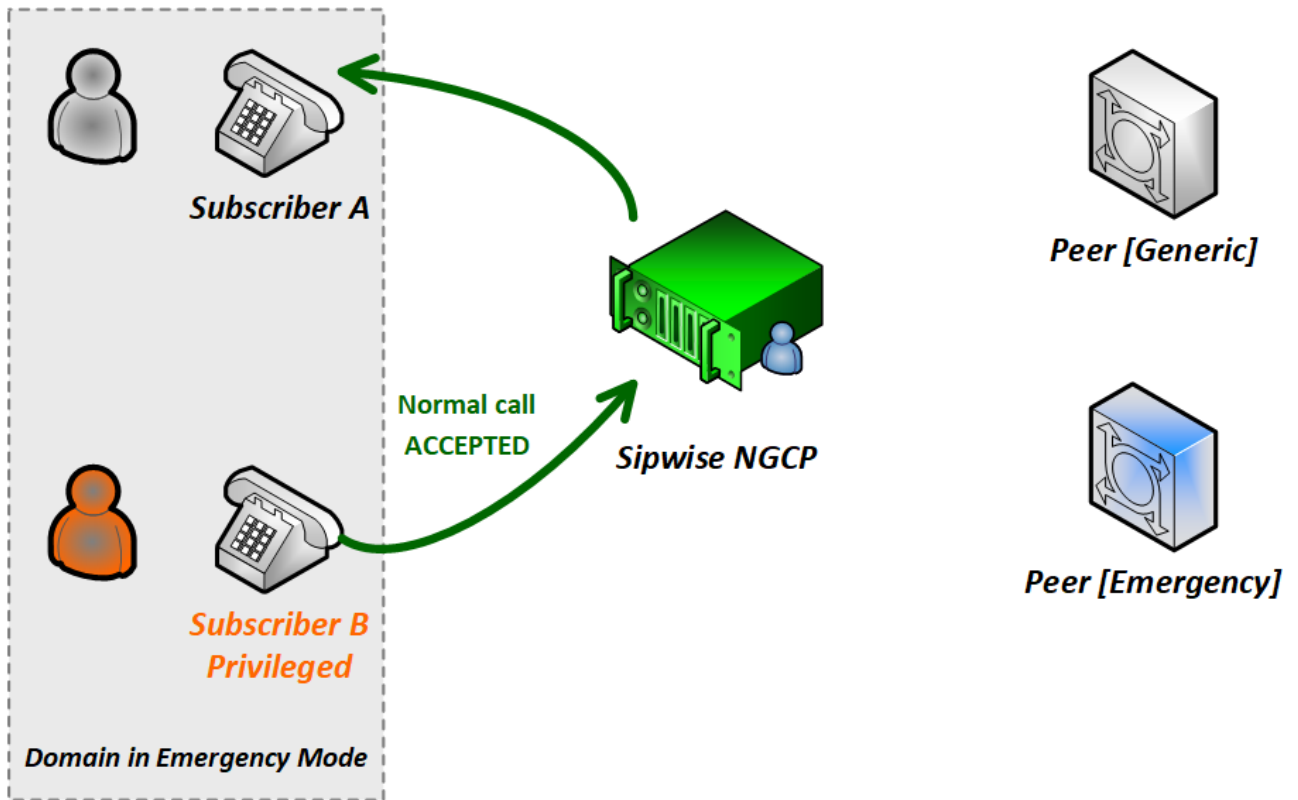

Figure 77. Call-flow in Emergency Mode 5. (Priv to Std)

6. A **privileged** subscriber makes a call **to an external subscriber (via peer)**. Result: the call will be **accepted**.

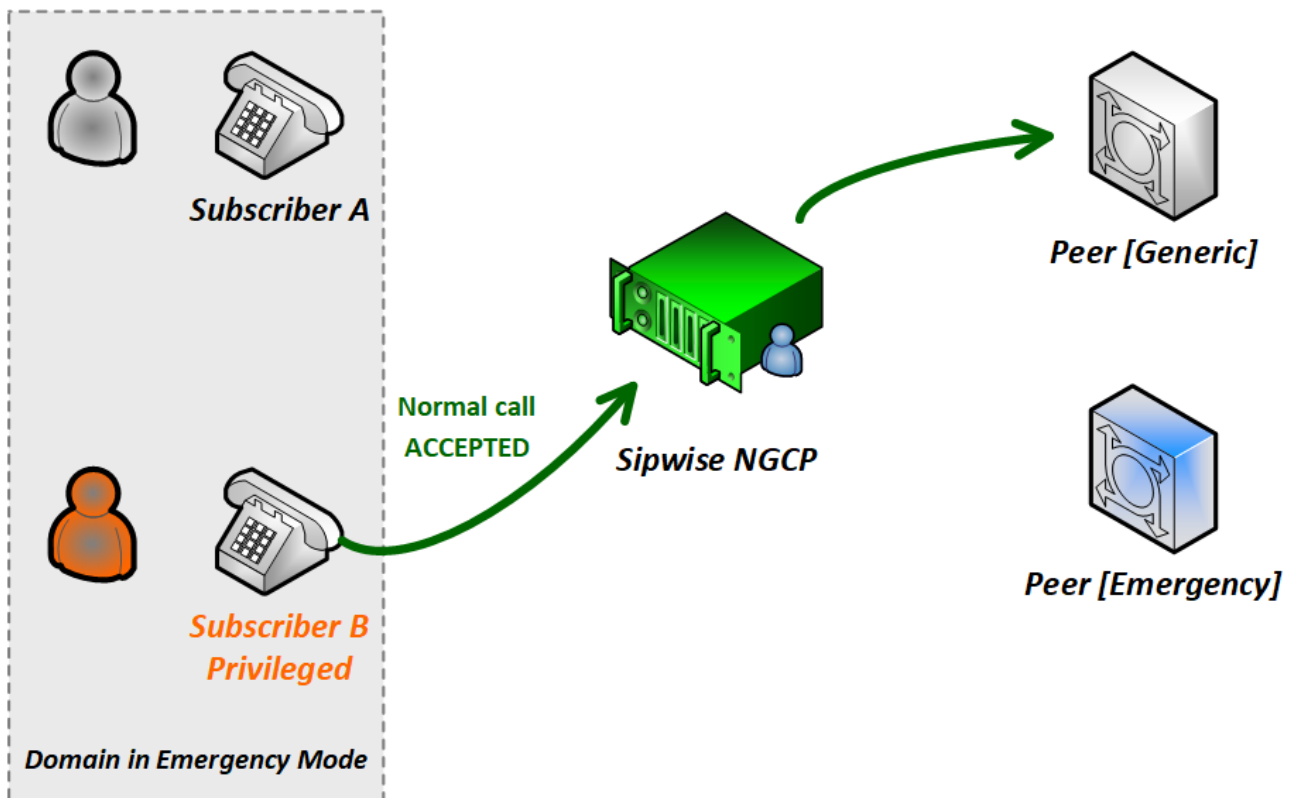

Figure 78. Call-flow in Emergency Mode 6. (Priv To Peer)

## 7.9.2. Configuration of Emergency Mode

The platform operator has to perform 2 steps of configuration so that the emergency mode can be activated. After the configuration is completed it is necessary to explicitly activate emergency mode, which can be accomplished as described in [Activating Emergency Mode](#) later.

### 1. System-level Configuration

The emergency prioritization function must be enabled for the whole system, otherwise emergency mode can not be activated. The platform operator has to set `kamailio.proxy.emergency_priorization.enabled` configuration parameter value to "yes" in the main configuration file `/etc/ngcp-config/config.yml`. Afterwards changes have to be applied in the usual way, with the command: `ngcpcfg apply "Enabled emergency prioritization"`

In order to learn about other parameters related to emergency prioritization please refer to [kamailio](#) part of the handbook.

### 2. Subscriber-level Configuration

The platform operator (or any administrator user) has the capability to declare a subscriber privileged, so that the subscriber can initiate and receive calls when emergency mode has been activated on the NGCP. In order to do that the administrator has to navigate to *Settings* *Subscribers* *select the subscriber* *Details* *Preferences* *Internals* *emergency\_priorization* on the **administrative web interface**, and press the *Edit* button.

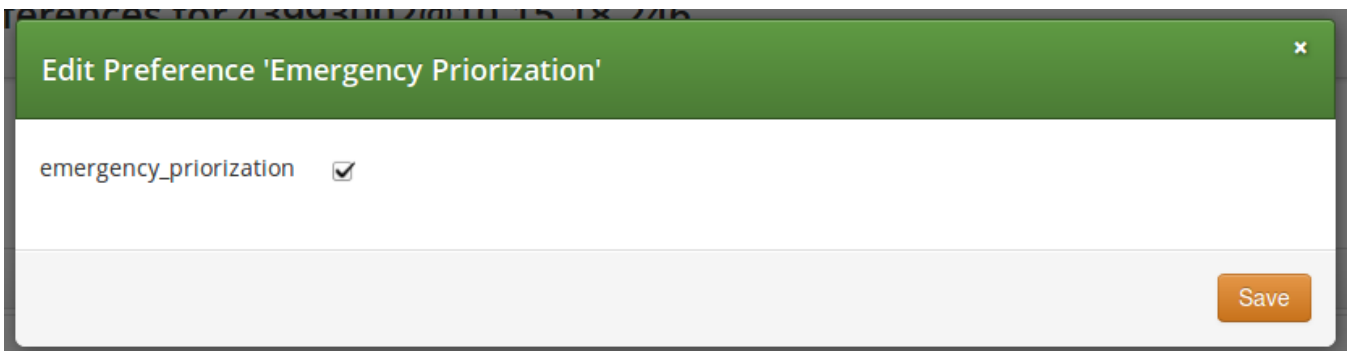

Figure 79. Emergency Priorization of Subscriber

The checkbox `emergency_priorization` has to be ticked and then press the *Save* button.

The same privilege can be added via the **REST API** for a subscriber: a HTTP PUT/PATCH request must be sent on `/api/subscriberpreferences/id` resource and the `emergency_priorization` property must be set to "true".

## 7.9.3. Activating Emergency Mode

The platform operator can activate emergency mode for a single or multiple domains in 3 different ways:

- via the administrative web interface
- via the REST API
- via a command-line tool

**IMPORTANT**

The interruption of ongoing calls is only possible with the command-line tool! Activating emergency mode for domains via the web interface or REST API will only affect upcoming calls.

**1. Activate emergency mode via web interface:** this way of activation is more appropriate if only a single (or just a few) domain is affected. Please navigate to *Settings Domains select a domain Preferences Internals emergency\_mode\_enabled Edit*.

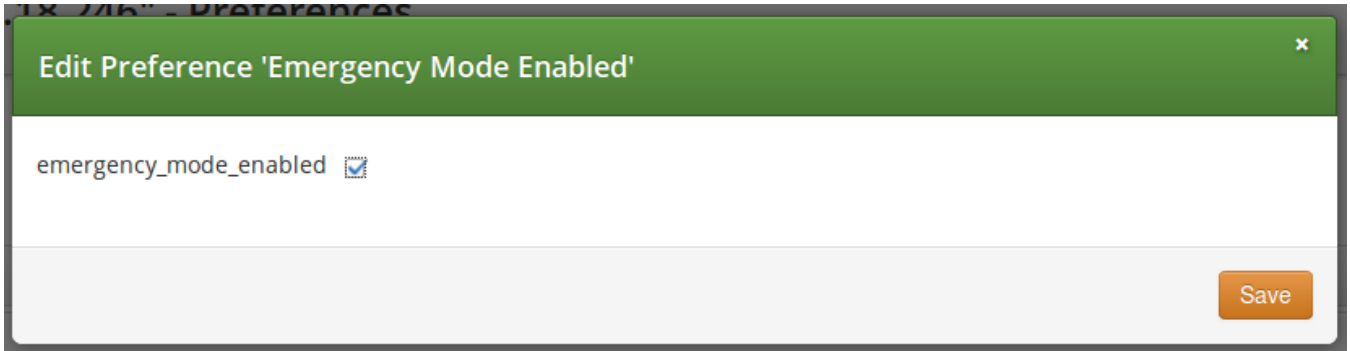

Figure 80. Activate Emergency Mode of Domain

The checkbox *emergency\_mode\_enabled* has to be ticked and then press the *Save* button.

**2. Activate emergency mode via REST API:** this way of activation is more appropriate if only a single (or just a few) domain is affected.

For that purpose a HTTP PUT/PATCH request must be sent on `/api/domainpreferences/id` resource and the `emergency_mode_enabled` property must be set to "true".

**3. Activate emergency mode using a command-line tool:** Sipwise C5 provides a built-in script that may be used to enable/disable emergency mode for some particular or all domains.

- Enable emergency mode:

```
> ngcp-emergency-mode enable <all|[domain1 domain2 ...]>
```

- Disable emergency mode:

```
> ngcp-emergency-mode disable <all|[domain1 domain2 ...]>
```

- Query the status of emergency mode:

```
> ngcp-emergency-mode status <all|[domain1 domain2 ...]>
```

## 7.10. Speed dials

Speed dials are short codes, prefixed by an '\*' (asterisk), that map a destination number. A list of speed dials can be configured on subscribers or customers level. Subscriber's speed dials allow the user to

configure a maximum of ten codes (based on 1-digit).

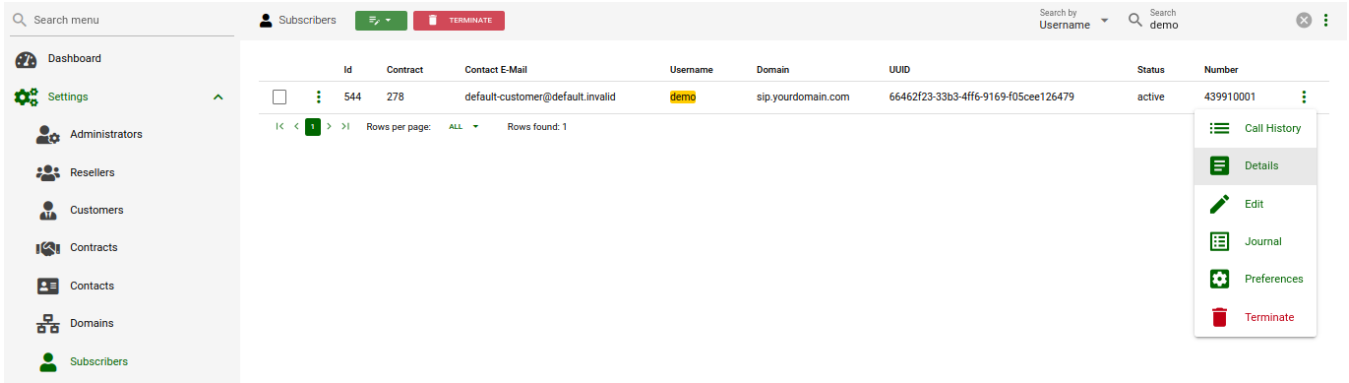

Figure 81. Subscriber Details

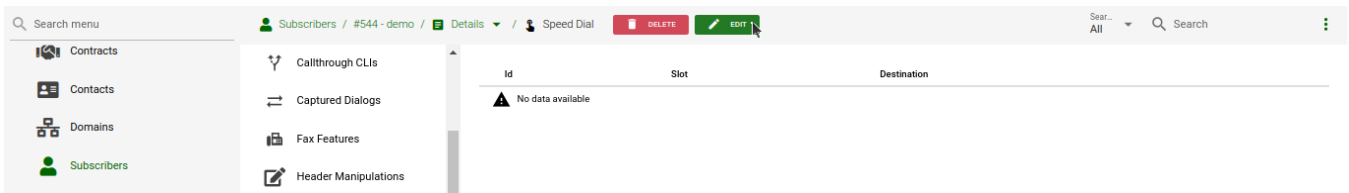

Figure 82. Speed dials

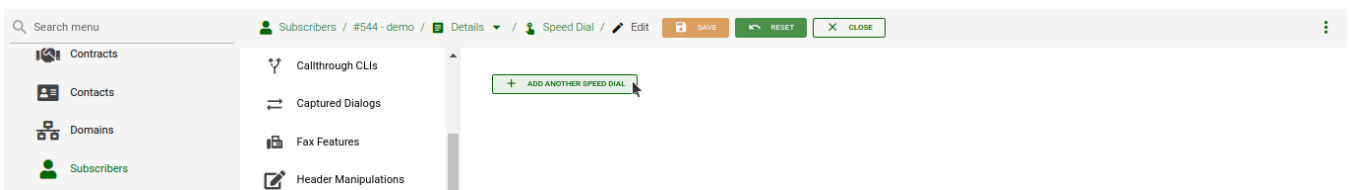

Figure 83. Add Speed dials

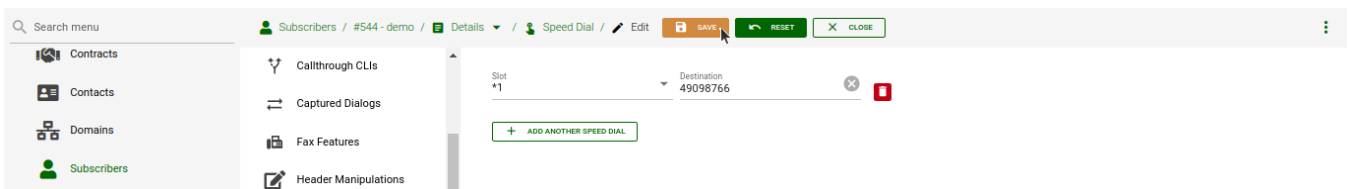

Figure 84. Set Speed dials

The list of pre-defined codes goes from \*0 till \*9. Below an example of a speed dial configured for a subscriber.

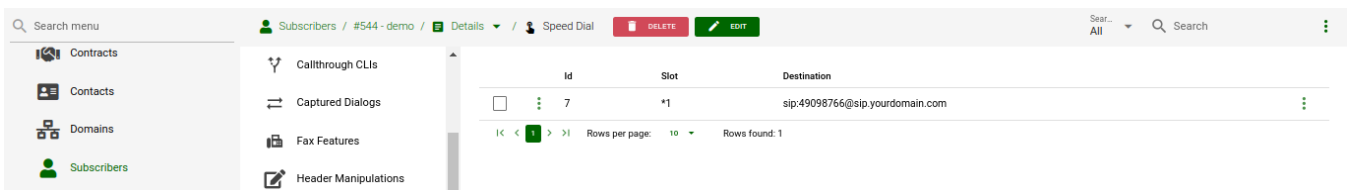

Figure 85. Available Speed dials

A similar configuration can be done on customer level too. Customer's Speed dials allow to configure a

maximum of one thousand codes (based on 3-digits), from \*000 till \*999. Each of the customer's speed dials will be visible and usable by all the subscriber belonging to that customer.

In both cases, when a subscriber wants to call the destination associated to the speed dial code, they simply dial \*X or \*XXX (in case of customer's speed dial).

## 7.11. SIP Message Filtering

### 7.11.1. Header Filtering

Adding additional SIP headers to the initial INVITES relayed to the callee (second leg) is possible by creating a [patchtt](#) file for the following template:

```
/etc/ngcp-config/templates/etc/sems-b2b/etc/ngcp.sbcprofile.conf.tt2.
```

The following section can be changed:

```
header_filter=whitelist
header_list=[%IF kamailio.proxy.debug == "yes"%]P-NGCP-CFGTEST, [%END%]
P-R-Uri,P-D-Uri,P-Preferred-Identity,P-Asserted-
Identity,Diversion,Privacy,
Allow,Supported,Require,RAck,RSeq,Rseq,User-Agent,History-Info,Call-Info
[%IF kamailio.proxy.presence.enable == "yes"%],Event,Expires,
Subscription-State,Accept[%END%] [%IF kamailio.proxy.allow_refer_method
== "yes"%],Referred-By,Refer-To,Replaces[%END%]
```

By default the system will remove from the second leg all the SIP headers which are not in the above list. If you want to keep some additional/custom SIP headers, coming from the first leg, into the second leg you need to add them at the end of the *header\_list*= list. After that, as usual, you need to apply and push the changes. In this way the system will keep your headers in the INVITE sent to the destination subscriber/peer.

#### WARNING

Refrain from making any adjustments to the list if you are not familiar with ALL the required procedures to do so.

### 7.11.2. Codec Filtering

At times, you may want to filter specific audio codecs from the SDP payload. For example, to prevent subscribers from using certain codecs or to require the use of a particular one. To achieve that you need to change the `/etc/ngcp-config/config.yml`, in the following section:

```
sdp_filter:
  codecs: PCMA,PCMU,telephone-event
  enable: yes
  mode: whitelist
```

In the example above, the system is removing all the audio CODECS from the initial INVITE except G711 a-law and  $\mu$ -law and telephone-event. In this way the callee will be notified that the caller is able to talk only PCMA. Another example is the blacklist mode:

```
sdp_filter:
  codecs: G729,G722
  enable: yes
  mode: blacklist
```

In this way the G729 and G722 will be removed from the SDP payload. In order to apply the changes, run

```
ngcpcfg apply 'Enable CODEC filtering'
ngcpcfg push all
```

#### WARNING

Codec filtering feature applies to SDP attributes and it does not remove a whole SDP media session in case all the related attributes match a filter rule. For example, this SDP video media session:

```
m=video 9078 RTP/AVPF 96 97
a=rtpmap:96 VP8/90000
a=rtpmap:97 H264/90000
a=fmtp:97 profile-level-id=42801F
```

in combination with:

```
sdp_filter:
  codecs: PCMA,PCMU,telephone-event
  enable: yes
  mode: whitelist
```

will result in no filtering at all because both codecs id 96 97 are not whitelisted and an empty media session is not allowed.

### 7.11.3. Codec Filtering with user preferences

Codec filtering management is also possible using the following preferences:

- codecs\_list
- codecs\_filter
- codecs\_id\_filter
- codecs\_id\_list

These preferences offer an alternative way to filter codecs without updating the configuration file and restarting the **kamailio-proxy** service. Since they can be applied at domain/peer/subscriber preferences level, they feature a more granular management compared when configuration is set via config.yml file, which is system wide.

The "codecs\_list" preference allows you to enter a list of codecs names, valid names are G722, PCMU,

PCMA, speex, GSM, G723, DVI4, L16, QCELP, CN, MPA, G728, DVI4, G729, AMR, AMR\*WB, opus, telephone-event, CelB, JPEG, H261, H263, H263\*1998, MPV, MP2T, nv, vp8, vp9, h264.

The "codecs\_id\_list" preference allows you to achieve the same result but in this case you will have to enter the corresponding CODEC-ID(s) payload type.

Once the list is filled, you have to specify if the codecs are going to be blacklisted or whitelisted by `kamailio-proxy`. This is done through the `codecs_filter` or the `codecs_id_filter` preferences.

If "codecs\_list" and "codecs\_id\_list" are set (and the corresponding `codecs_list/codec_id_list`), both filters will be applied sequentially: the list of codecs resulting from "codecs\_list" filtering will be used as input for the second "codecs\_id\_list" filtering.

By default, the codecs filter preferences are cleared (blacklisted) causing all codecs listed inside the codecs lists preferences to be filtered out. Differently, if the codecs filters are set, only the ones inside the codecs list will be retained causing the others to be filtered out.

### WARNING

The `codecs_filter` preference is tied to `codecs_list` and only operates on codecs entered inside that list. Likewise for `codecs_id_filter` and `codecs_id_list`, respectively. Ensure that these do not get mixed.

Examples:

- Example 1

`codecs_list: "G729"`

`codecs_filter: unset (false)`

SDP IN:

```
m=audio 6000 RTP/AVP 8 0 18 101
a=rtpmap:8 PCMA/8000
a=rtpmap:0 PCMU/8000
a=rtpmap:18 G729/8000
a=rtpmap:101 telephone-event/8000
```

SDP OUT:

```
m=audio 30000 RTP/AVP 8 0 101
a=rtpmap:8 PCMA/8000
a=rtpmap:0 PCMU/8000
a=rtpmap:101 telephone-event/8000
```

Codec G729 has been filtered out because blacklisted in `codecs_list`.

- Example 2

`codecs_id_list: "18"`

`codecs_id_filter: set (true)`

SDP IN:

```
m=audio 6000 RTP/AVP 8 0 18 101
a=rtpmap:8 PCMA/8000
a=rtpmap:0 PCMU/8000
a=rtpmap:18 G729/8000
a=rtpmap:101 telephone-event/8000
```

SDP OUT:

```
m=audio 30108 RTP/AVP 18
a=rtpmap:18 G729/8000
```

Codec G729 is retained because whitelisted, PCMA PCMU have been filtered out because they are not whitelisted.

#### 7.11.4. Enable History and Diversion Headers

It may be useful and mandatory - specially with NGN interconnection - to enable SIP History header and/or Diversion header for outbound requests to a peer or even for on-net calls. In order to do so, you should enable the following preferences in Domain's and Peer's Preferences:

- Domain's Preferences: *inbound\_uprn* = **Forwarder's NPN**
- Peer's Preferences: *outbound\_history\_info* = **UPRN**
- Peer's Preferences: *outbound\_diversion* = **UPRN**
- Domain's Preferences: *outbound\_history\_info* = **UPRN** (if you want to allow History Header for on-net call as well)
- Domain's Preferences: *outbound\_diversion* = **UPRN** (if you want to allow Diversion Header for on-net call as well)

#### 7.11.5. User Agent Filtering

It could be useful to filter the received REGISTER and INVITE requests based on the User-Agent header's value. For example, if you want to force your subscribers to use certain type/model of devices. To do that system wide you need to change the `/etc/ngcp-config/config.yml`, in the following section:

```
kamailio:
  lb:
    block_useragents:
      action: reject
      block_empty: no
      block_absent: no
      enable: yes
      mode: whitelist
      ua_patterns:
        - Yealink.*
```

In the example above, the system allows all the requests, which have the User-Agent header beginning with 'Yealink' value. All other UACs will be rejected with the *403 Forbidden* message. To silently drop the received message, it is possible to specify the *drop* action instead of the default *reject*.

Another example is the blacklist mode:

```
kamailio:
  lb:
    block_useragents:
      action: drop
      block_empty: no
      block_absent: no
      enable: yes
      mode: blacklist
      ua_patterns:
        - friendly-scanner
```

In the example above the Sipwise C5 drops all requests, which have the User-Agent header equal to 'friendly-scanner'. Since there is the *drop* action, these messages will be dropped silently, without providing a response to the sender.

Another example with *block\_empty*: and *block\_absent*: options set to 'yes':

```
kamailio:
  lb:
    block_useragents:
      action: reject
      block_empty: yes
      block_absent: yes
      enable: yes
      mode: whitelist
      ua_patterns: []
```

In the example above the Sipwise C5 rejects all requests, which have the User-Agent header absent or the User-Agent header with no value. Such requests will be rejected with a *403 Forbidden* message. It's possible to set only one of the options (*block\_empty*: / *block\_absent*:) to 'yes'. As well as it's possible to keep both of them enabled.

In order to apply the changes, run the following:

```
ngcpcfg apply 'Enable User-Agent filtering'
ngcpcfg push all
```

### IMPORTANT

Please note that implementing these changes will require a restart of the LB component. It is advisable to schedule this only during non-working hours.

Regardless of the system-wide configuration (UA filtering enabled globally or not), it is possible to define a specific User-Agent filtering for each Domain or Subscriber. In order to do so, you should

configure the following fields in Domain's or Subscriber's Preferences section:

- `ua_filter_list`: Contains wildcard list of allowed or denied SIP User-Agents matched against the User-Agent header.
- `ua_filter_mode`: Specifies the operational mode of the SIP User-Agent Filter List: Blacklist or Whitelist.
- `ua_reject_missing`: Rejects any request if no User-Agent header is given.

In case of rejection the response with code `kamailio.proxy.early_rejects.block_admin.announce_code` and reason `kamailio.proxy.early_rejects.block_admin.announce_reason` will be sent back to the subscriber.

## 7.12. SIP Trunking with SIPconnect

### 7.12.1. User provisioning

For the purpose of external SIP-PBX interconnect with the Sipwise C5, the platform admin should create a subscriber with multiple aliases, representing the numbers and number ranges served by the SIP-PBX.

- Subscriber username - any SIP username that forms an "email-style" SIP URI.
- Subscriber Aliases - numbers in the global E.164 format without the leading plus.

To configure the Subscriber, go to *SettingsSubscribers*, click the three dotted icon and click *Preferences* on the row of your subscriber.

You should look into the *Number Manipulations* and *Access Restrictions* sections in particular, which control the calling and called number presentation.

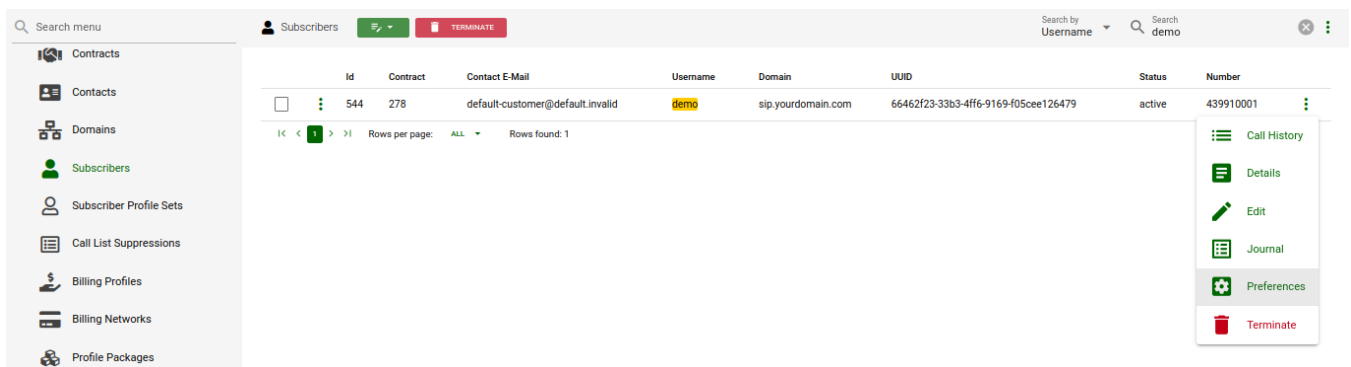

The screenshot shows the Sipwise web interface for managing subscribers. The main content area displays a table with the following data:

Id	Contract	Contact E-Mail	Username	Domain	UUID	Status	Number
544	278	default-customer@default.invalid	demo	sip.yourdomain.com	66462f23-33b3-4ff6-9169-f05cee126479	active	439910001

Below the table, there is a navigation menu with the following options: Call History, Details, Edit, Journal, Preferences, and Terminate. The 'Preferences' option is highlighted.

Figure 86. Subscriber Preferences

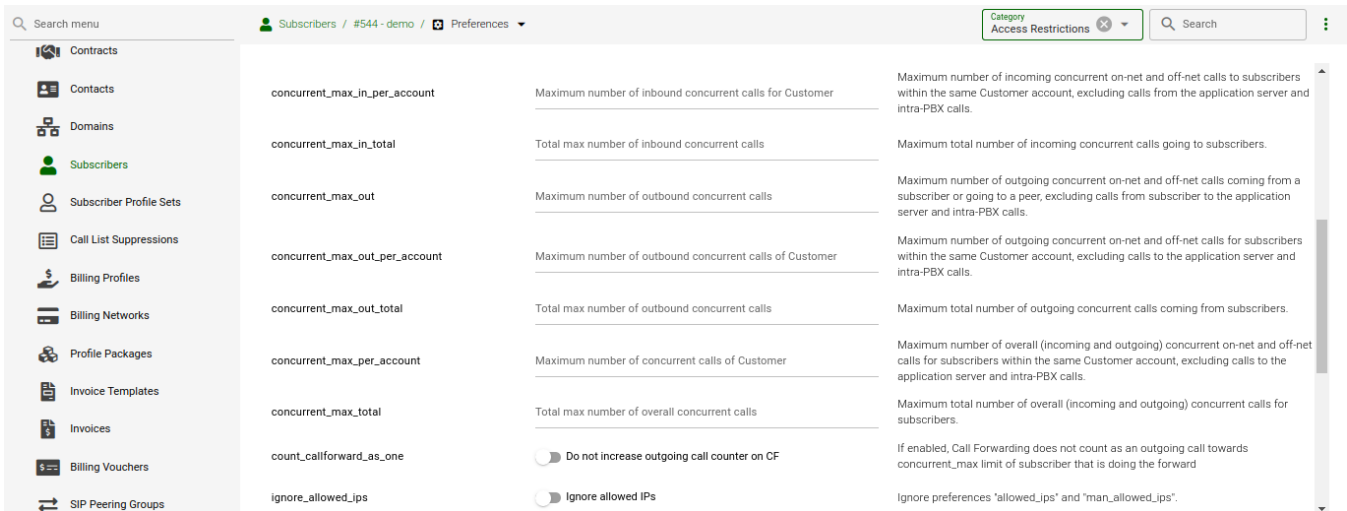

Figure 87. Subscribers Preferences - Access Restrictions

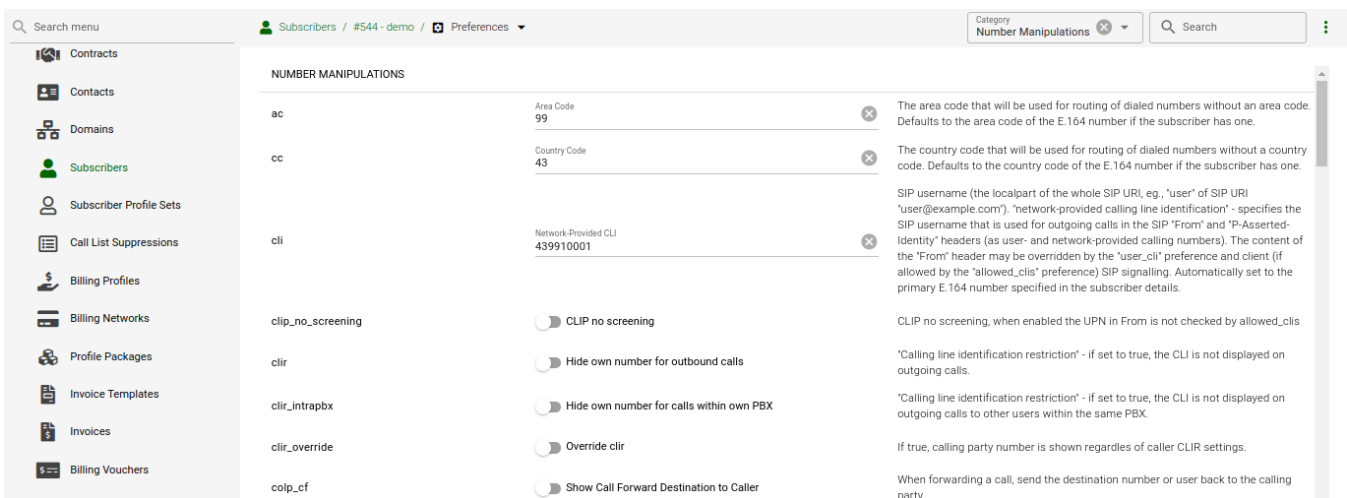

Figure 88. Subscribers Preferences - Number Manipulations

### 7.12.2. Inbound calls routing

Enable preference *Number Manipulationse164\_to\_ruri* for routing inbound calls to SIP-PBX. This ensures that the Request-URI will comprise a SIP-URI containing the dialed alias-number as user-part, instead of the user-part of the registered AOR (which is normally a static value).

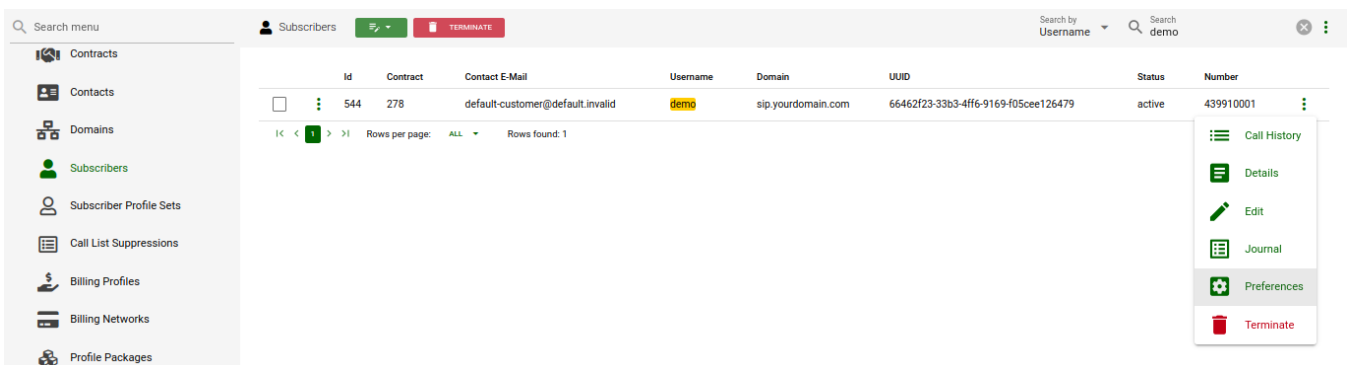

Figure 89. Subscriber Preferences

Search menu   Subscribers / #544 - demo / Preferences   Category: Number Manipulations   Search

Setting	Value	Description
colp_pstn	<input type="checkbox"/>	Show PSTN Destination to Caller: When calling PSTN, show the destination number or user back to the calling party.
display_name	Network-Provided Display Name	The network-provided display name used for XMPP contacts and optionally SIP outbound header manipulation.
e164_to_uri	<input checked="" type="checkbox"/>	Use Number instead of Contact first for outbound calls: Send the E164 number instead of SIP AOR as request username when sending INVITE to the subscriber. If a 404 is received the SIP AOR is sent as request URI as fallback.
emergency_cli	Emergency CLI	SIP username (the localpart of the whole SIP URI, eg., 'user' of SIP URI 'user@example.com'). Emergency CLI which can be used in rewrite rules as substitution value.
emergency_location_format	Emergency location format: cirpack	Defines the format of emergency_location_object
emergency_location_object	MIME encapsulated Location Information in the INVITE	SDP MIME object related to location to be added on an emergency call
emergency_mapping_container	Emergency Mapping Container	Specifies the emergency mapping container to be used for this subscriber to map emergency numbers to emergency prefixes.
emergency_prefix	Emergency Prefix variable	A numeric string intended to be used in rewrite rules for emergency numbers.
emergency_suffix	Emergency Suffix variable	A numeric string intended to be used in rewrite rules for emergency numbers.

Figure 90. Subscriber Preferences - e164-to-uri

## Fallback behaviours

Sipwise C5 can enhance pbx integration providing four different extended dialing modes:

- Strict number matching: dialing arbitrary extension behind subscriber number is not allowed
- Extended matching, send dialed number with extension: the system will locate the subscriber by longest matching prefix, only the whole dialed number (base number + extension) will be written inside the Request URI user part.
- Extended matching, send base matching number: the system will locate the subscriber by longest matching prefix, only the base number or subscriber username will be written inside the Request URI user part.
- Extended matching, send primary number with extension: the system will locate the subscriber by longest matching prefix, the new Request URI user part will be equal to the primary number with appended the extension (calculated using the exceeding part of the callee).

Search menu   Subscribers   TERMINATE   Search by Username   Search demo

Id	Contract	Contact E-Mail	Username	Domain	UUID	Status	Number
544	278	default-customer@default.invalid	demo	sip.yourdomain.com	66462f23-33b3-4ff6-9169-f05cee126479	active	439910001

Rows per page: ALL   Rows found: 1

- Call History
- Details
- Edit
- Journal
- Preferences
- Terminate

Figure 91. Subscriber Preferences

Setting Name	Value / Description	Configuration / Description
emergency_upn	Emergency User-Provided-Number Field	Select if, in case of emergency calls, the subscriber's User-Provided-Number is overwritten with the Network-Provided-Number (default) or not.
extended_dialing_mode	Incoming Dialed Number Matching	"Incoming Dialed Number Matching" - configure between strict number matching for incoming calls where dialing arbitrary extension behind subscriber number is not allowed and the extended number matching, where the system will locate the subscriber by longest matching prefix and will send either the base matching number or the original dialed number with extension (with possible fallback to user on 404 response from callee).
extension_in_npn	<input checked="" type="checkbox"/> Use valid Alias CLI as NPN	Search for partial match of user-provided number (UPN) to subscriber's primary E164 number and aliases. If it matches, take UPN as valid without allowed_cli check and copy UPN to network-provided number (NPN).
force_outb_call_uses_peer_hdrs	<input checked="" type="checkbox"/> Use peer-specific outbound headers when call is forced to peer	If enabled, set the outbound headers as per peer outbound_* preferences when the call is forced to the peer by force_outbound_calls_to_peer setting. Otherwise, the outbound headers are controlled by the user/domain settings of the subscriber which forces the call to peer (by default).
inbound_upn	Inbound User-Provided Number	The SIP header field to fetch the user-provided-number from for inbound calls
inbound_upn	Inbound User-Provided Redirecting Number	Specifies the way to obtain the User-Provided Redirecting CLI. Possible options are use NPN of forwarding subscriber or respect inbound Diversion header. Same validation rules as for UPN apply to UPRN. NGCP does not stack UPRNs up if the call is forwarded several times.
manager_secretary	<input checked="" type="checkbox"/> "Manager Secretary" call forwardings toggle	Turns on and off "Manager Secretary" call forwardings

Figure 92. Subscriber Preferences - extended-dialing-mode

Extended dialing modes are editable under *Number Manipulations* `extended_dialing_mode`.

Fallback procedure is on by default and usually applies to extended matching or `e164_to_ruri` modes. If the callee UAC replies with a 404 not found error, the fallback feature triggers the generation of a new INVITE. In this case the new Request URI will be set accordingly to the `extended_dialing_mode` and `e164_to_ruri` values.

The whole 404 fallback procedure can however be disabled activating the `no_404_fallback` option under subscriber's or domain's preferences.

### 7.12.3. Number manipulations

The following sections describe the recommended configuration for correct call routing and CLI presentation according to the SIPConnect 2.0 recommendation.

#### Rewrite rules

The SIP PBX by default inherits the domain dialplan which usually has rewrite rules applied to normal Class 5 subscribers with inbound rewrite rules normalizing the dialed number to the E.164 standard. If most users of this domain are Class 5 subscribers the dialplan may supply calling number in national format - see [Configuring Rewrite Rule Sets](#). While the SIP-PBX trunk configuration can be sometimes amended it is a good idea in sense of SIPconnect recommendation to send only the global E.164 numbers.

Moreover, in mixed environments with the Sipwise C5 Cloud PBX sharing the same domain with SIP trunking (SIP-PBX) customers, the subscribers may have different rewrite rules sets assigned to them. The difference is caused by the fact that the dialplan for Cloud PBX is fundamentally different from the dialplan for SIP trunks due to extension dialing, where the Cloud PBX subscribers use the break-out code (see [Preparing PBX Rewrite Rules](#))

to dial numbers outside of this PBX.

The SIPconnect compliant numbering plan can be accommodated by assigning Rewrite Rules Set to the SIP-PBX subscriber. Below is a sample Rewrite Rule Set for using the global E.164 numbers with plus required for the calling and called number format compliant to the recommendation.

*Inbound Rewrite Rule for Caller*

- Match Pattern: `^(00|+)([1-9][0-9]+)$`
- Replacement Pattern: `\2`
- Description: **International to E.164**
- Direction: **Inbound**
- Field: **Caller**

*Inbound Rewrite Rule for Callee*

- Match Pattern: `^(00|+)([1-9][0-9]+)$`
- Replacement Pattern: `\2`
- Description: **International to E.164**
- Direction: **Inbound**
- Field: **Callee**

*Outbound Rewrite Rule for Caller*

- Match Pattern: `^([1-9][0-9]+)$`
- Replacement Pattern: `+\1`
- Description: **For the calls to SIP-PBX add plus to E.164**
- Direction: **Outbound**
- Field: **Caller**

*Outbound Rewrite Rule for Callee*

- Match Pattern: `^([1-9][0-9]+)$`
- Replacement Pattern: `+\1`
- Description: **For the calls to SIP-PBX add plus to E.164**
- Direction: **Outbound**
- Field: **Callee**

Assign the aforementioned Rewrite Rule Set to the SIP-PBX subscribers.

**WARNING**

Outbound Rewrite Rules for Callee shall NOT be applied to the calls to normal SIP UAs like IP phones since the number with plus does not correspond to their SIP username.

**User parameter**

The following configuration is needed for your platform to populate the From and To headers and Request-URI of the INVITE request with "user=phone" parameter as per RFC 3261 Section 19.1.1 (if the user part of the URI contains telephone number formatted as a telephone-subscriber).

- Domain's Preferences: `outbound_from_user_is_phone = Y`

- Domain's Preferences: *outbound\_to\_user\_is\_phone* = Y

## Forwarding number

The following is our common configuration that covers the calling number presentation in a variety of use-cases, including the incoming calls, on-net calls and Call Forward by the platform:

- Domain's Preferences: *inbound\_uprn* = **Forwarder's NPN**
- Domain's Preferences: *outbound\_from\_user* = **UPRN (if set) or User-Provided Number**
- Domain's Preferences: *outbound\_pai\_user* = **UPRN (if set) or Network-Provided Number**
- Domain's Preferences: *outbound\_history\_info* = **UPRN** (if the called user expects History-Info header)
- Domain's Preferences: *outbound\_diversion* = **UPRN** (if the called user expects Diversion header)
- Domain's Preferences: *outbound\_to\_user* = **Original (Forwarding) called user** if the callee expects the number of the subscriber forwarding the call, otherwise leave default.

The above parameters can be tuned to operator specifics as required. You can override these settings in the Subscriber Preferences if particular subscribers need special settings.

### TIP

On outgoing call from SIP-PBX subscriber the Network-Provided Number (NPN) is set to the *cli* preference prefilled with main E.164 number. In order to have the full alias number as NPN on outgoing call set preference *extension\_in\_npn* = Y.

### *Externally forwarded call*

If the call forward takes place inside the SIP-PBX it can use one of the following specification for signaling the diversion number to the platform:

- using **Diversion** method (RFC 5806): configure Subscriber's Preferences: *inbound\_uprn* = **Forwarder's NPN / Received Diversion**
- using **History-Info** method (RFC 7044): the Sipwise C5 platform extends the History-Info header received from the PBX by adding another level of indexing according to the specification RFC 7044.

## Allowed CLIs

- For correct calling number presentation on outgoing calls, you should include the pattern matching all the alias numbers of SIP-PBX or each individual alias number under the *allowed\_clis* preference.
- If the signalling calling number (usually taken from From user-part, see *inbound\_upn* preferences) does not match the *allowed\_clis* pattern, the *user\_cli* or *cli* preference (Network-Provided Number) will be used for calling number presentation.

## 7.12.4. Registration

SIP-PBX can use either Static or Registration Mode. While SIPConnect 2.0 support for TLS is a MUST, one should note that using TLS for signaling does not require the use of the SIP URIs scheme. SIP URIs scheme is obsolete for this purpose.

### *Static Mode*

While SIPConnect 2.0 allows the use of Static mode, this poses additional maintenance overhead on

the operator. The administrator should create a static registration for the SIP-PBX: go to Subscribers, three dotted icon, *DetailsRegistered DevicesAdd* and put the address of the SIP-PBX in the following format: sip:username@ipaddress:5060 where username=username portion of SIP URI and ipaddress = IP address of the device.

### Registration Mode

It is recommended to use the Registration mode with SIP credentials defined for the SIP-PBX subscriber.

#### IMPORTANT

The use of RFC 6140 style "bulk number registration" is discouraged. The SIP-PBX should register one AOR with email-style SIP URI. The Sipwise C5 will take care of routing the aliases to the AOR with *e164\_to\_ruri* preference.

### Trusted Sources

If a SIP-PBX cannot perform the digest authentication, you can authenticate it by its source IP address in the Sipwise C5. To configure the IP-based authentication, go to the subscriber's preferences (*Details Trusted Sources*) and specify the IP address of the SIP-PBX in the *Source IP* field.

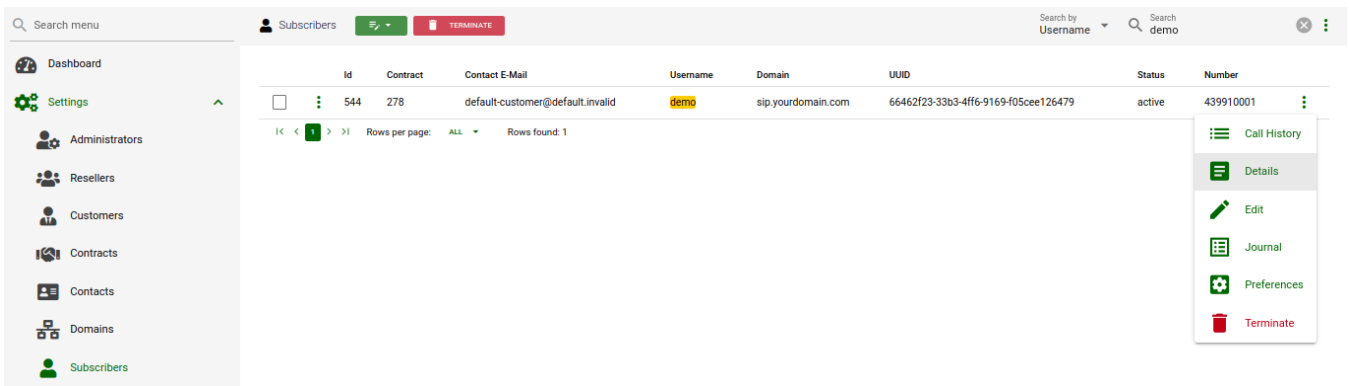

Figure 93. Subscriber Details

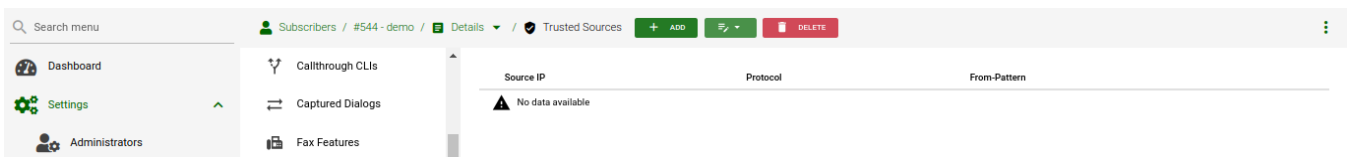

Figure 94. Trusted Sources

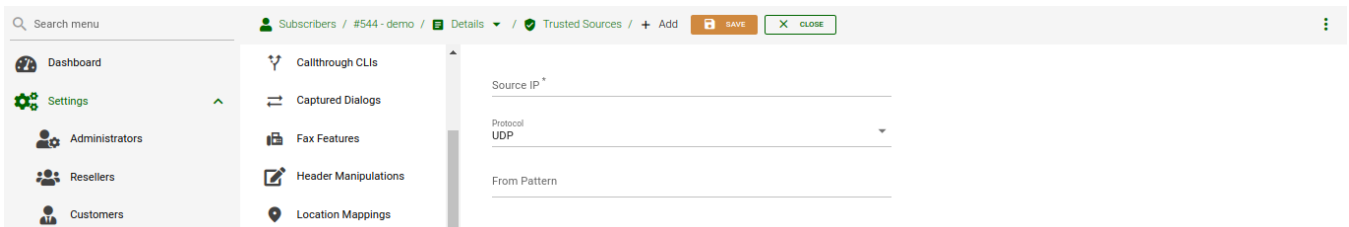

Figure 95. Add Trusted Sources

To authenticate multiple subscribers from the same IP address, use the *From* field to distinguish these subscribers.

When this feature is configured for a subscriber, the Sipwise C5 authenticates all calls that arrive from the specified IP address without challenging them.

### IMPORTANT

If the same IP address and the FROM field are mistakenly specified as trusted for different subscribers, the Sipwise C5 will not know which subscriber to charge for the call and will randomly select one.

## 7.13. Trusted Subscribers

In some cases, when you have a device that cannot authenticate itself against Sipwise C5, you may need to create a *Trusted Subscriber*. Trusted Subscribers use IP-based authentication and they have a Permanent SIP Registration URI in order to receive messages from the Sipwise C5.

In order to make a regular subscriber trusted, perform the following extra steps:

- Create a permanent registration via (*SubscribersDetails Registered DevicesCreate Permanent Registration*)
- Add the IP address of the device as Trusted Source in your subscriber's preferences (*Details PreferencesTrusted Sources*).

Figure 96. Subscriber Details

Figure 97. Add Subscriber Registered Devices

Figure 98. Subscriber Registered Devices

This way, all SIP messages coming from the device IP will be considered trusted (and get authenticated only by the source IP). All the SIP messages forwarded to the devices will be sent to the SIP URI specified in the subscriber's permanent registration.

## 7.14. Peer Probing

The basic way of selecting the appropriate peering server, where an outbound call can be routed to, has already been described in [Routing Order Selection](#) of the handbook.

### 7.14.1. Introduction to Peer Probing Feature

The Sipwise C5 provides a web admin panel and API capabilities to configure peering servers in order to terminate calls to non-local subscribers. Those peering servers may become *temporarily unavailable* due to overloading or networking issues. The Sipwise C5 will fail over to another peering server (matching the corresponding peering rules) after a timeout configured at system level (see the `b2b.sbc.outbound_timeout` configuration parameter; 6 sec by default), if no provisional response (a response with a code in the range of 100 to 199) is received for the outbound INVITE request.

Even if this timer is set much lower, like 3 sec, the call setup time is increased significantly. This is even more true if multiple peering servers fail at the same time, which will sum up the individual timeouts, finally *causing call setup times reach the order of tens of seconds*.

To optimize the call setup time in such scenarios, a new feature is implemented to *continuously probe peering servers* via SIP messages, and mark them as unavailable on timeout or when receiving unexpected response codes. Appropriate SIP response codes from the peering servers will mark them as available again.

Peering servers *marked as unavailable* are then *skipped during call routing* in the peering selection process, which significantly shortens the call setup times if peering servers fail.

### 7.14.2. Configuration of Peer Probing

The system administrator has to configure the peer probing feature in 2 steps:

1. System-level configuration enables the peer probing feature in general on the Sipwise C5 and determines the operational parameters, such as timeouts, the SIP method used for probing requests, etc.
2. Peering server configuration will add / remove a peering server to the list of probed endpoints.

#### System-level Configuration

The parameters of peer probing are found in the main system configuration file `/etc/ngcp-config/config.yml`. You can see the complete list of configuration parameters in [kamailio](#) of the handbook, while the most significant ones are discussed here.

**Enabling peer probing** system-wide happens through the `kamailio.proxy.peer_probe.enable` parameter. If it is set to 'yes' (which is the default value), the Sipwise C5 will consider probing of individual peering servers based on their settings.

**Timeout** of a single probing request can be defined through `kamailio.proxy.peer_probe.timeout` parameter. This is a value interpreted as seconds while Sipwise C5 will wait for a SIP response from the peering server. Default is 5 seconds.

The **probing interval** can be set through the `kamailio.proxy.peer_probe.interval` parameter. This is the time period in seconds that determines how often a probing request is sent to the peering servers. Default is 10 seconds.

The **SIP method** used for probing requests can be defined through `kamailio.proxy.peer_probe.method` parameter. Allowed values are: OPTIONS (default) and INFO.

**TIP**

The system administrator, in most of the cases, will not need to modify the default configuration values other than that of timeout and interval.

**If no available peering server is found, the call is rejected** with the response code and reason configured in `kamailio.proxy.early_rejects.peering_unavailable.announce_code` and `kamailio.proxy.early_rejects.peering_unavailable.announce_reason`. If a sound file is configured within the *system sound set* assigned to the calling party, an announcement is played as early media before the rejection.

## Individual Peering Server Configuration

When the peer probing feature is enabled on system-level, it is possible to add each individual peering server to the list of probed endpoints. You can change the probed status of a server in two ways:

### Enable probing of a peering server via the admin web interface

1. Open the properties panel of a peering server: *Peerings* *select a peering group* *Details* *select a peering server* *Edit*
2. Tick the checkbox *Enable Probing*
3. *Save changes*

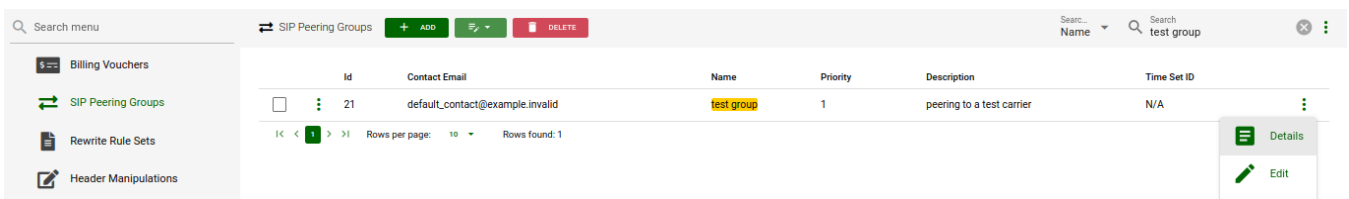

Figure 99. SIP Peering Group Details

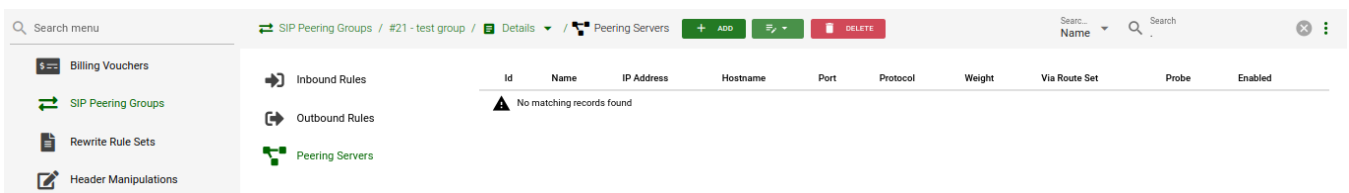

Figure 100. Add Peering Server

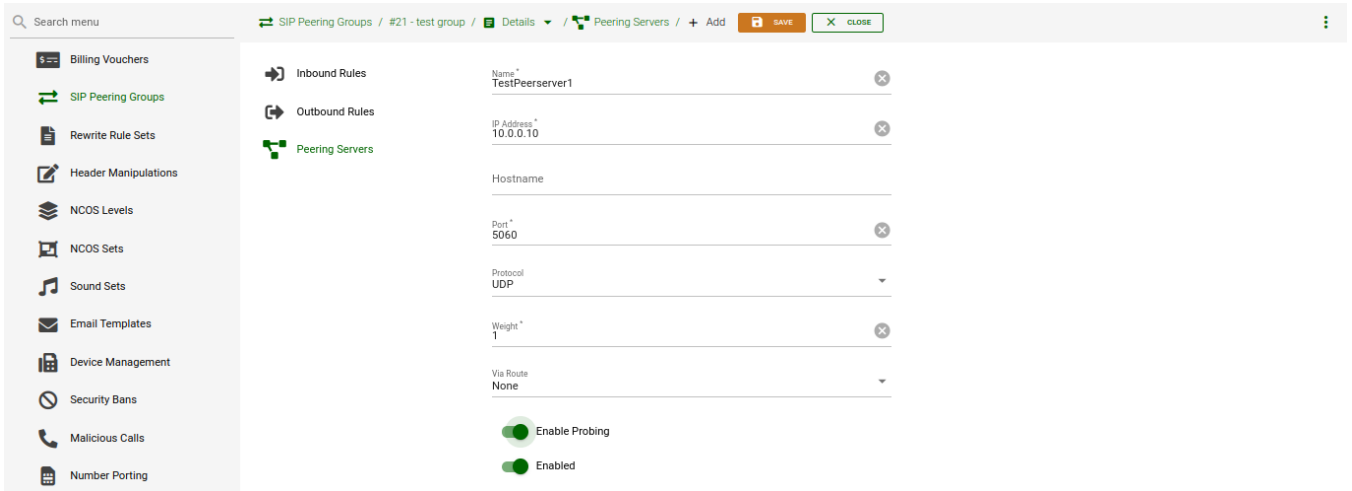

Figure 101. Enable Probing of Peering Server

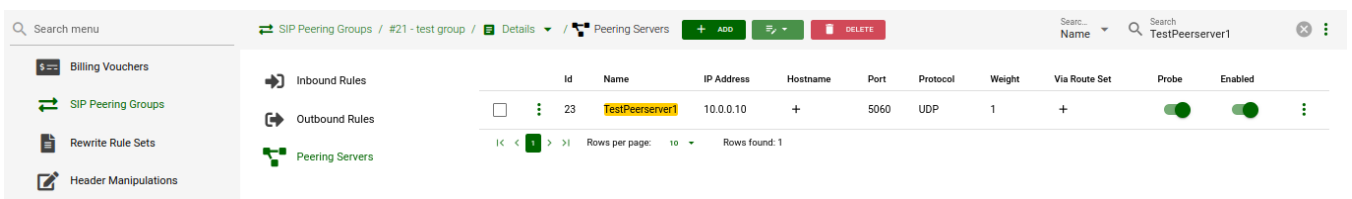

Figure 102. Enable Probing of Peering Server

### Enable probing of a peering server via the REST API

- when you *create a new peering server* you will use an HTTP *POST* request and the target URL:

[https://<IP\\_of\\_NGCP>:1443/api/peeringservers](https://<IP_of_NGCP>:1443/api/peeringservers)

- when you *update an existing peering server* you will use an HTTP *PUT* or *PATCH* request and the target URL:

[https://<IP\\_of\\_NGCP>:1443/api/peeringservers/id](https://<IP_of_NGCP>:1443/api/peeringservers/id)

In all cases you have to set the 'probe' property to **true** in order to enable probing, and to **false** in order to disable probing. Default value is **false** and this property may be omitted in a create/update request, which ensures backward compatibility of the `/api/peeringservers` API resource.

#### TIP

For more information about the REST API, you can access the documentation included in your system by accessing this URL [https://<IP\\_of\\_NGCP>:1443/api/](https://<IP_of_NGCP>:1443/api/)

### 7.14.3. Monitoring of Peer Probing

Peering server states, such as "reachable" / "unreachable", are continuously stored in a time-series database (Prometheus compatible database) by the Sipwise C5 Proxy nodes. It is possible to **graphically represent the state of peering servers** on NGCP's admin web interface, just like other system variables (like CPU and memory usage, number of registered subscribers, etc.). However this is not yet available by default.

Alarm conditions or state change events of peering servers are also reported by means of **SNMP traps**. An event trap is emitted each time the reachable state of one of the monitored peering servers

changes. An alarm trap is emitted on problematic conditions arising or clearing.

The Sipwise MIB is extended by a table of peers per proxy, containing the peer ID and the peer name, along with the peer probe status. An external monitoring system can **poll the peers table via SNMP** to gather the peer status from each proxy's point of view.

The peer information for all nodes is stored in a table rooted at the OID `.1.3.6.1.4.1.34274.1.1.2.40.2.1` with the following OID path:

```
.iso.org.dod.internet.private.enterprises.sipwise.ngcp.ngcpObjects.ngcpMonitor.ngcpMonitorPeering.psTable
```

The peer status is an indexed element of that table at the OID `.1.3.6.1.4.1.34274.1.1.2.40.2.1.7` with the following OID path:

```
.iso.org.dod.internet.private.enterprises.sipwise.ngcp.ngcpObjects.ngcpMonitor.ngcpMonitorPeering.psTable.psEntry.psPeerStatus
```

Value of *psPeerStatus* can be:

- 0: unknown
- 1: administratively down
- 2: administratively up
- 3: probed, pending
- 4: probed, down
- 5: probed, up

#### 7.14.4. Further Details for Advanced Users

##### TIP

This subchapter of the handbook is targeted on advanced system operators and Sipwise engineers. Reading this section is not essential for effectively managing the peer probing feature of the NGCP.

#### Behaviour of Kamailio Proxy Instances

Each *kamailio-proxy* instance on the proxy nodes performs the probing individually for performance reasons. Each proxy holds its result in its cache to avoid central storage and replication of the probing results.

Each proxy will send an SNMP event trap if it detects a state change or an SNMP alarm trap for problematic conditions arising or clearing for a peering server, because proxies might be geographically distributed along with their load-balancers and can therefore experience different probing results.

Each peering server is cross-checked against the hash table filled during outbound probing requests and is skipped by call routing logic, if a match is found.

On start or restart of the *kamailio-proxy* instance, the probing will start after the first interval, and NOT

immediately after start. In the first probing interval the proxy will always try to send call traffic to peering servers until the first probing round is finished, and will only then start to skip unavailable peering servers.

### Changes to Kamailio Proxy Configuration

A new configuration template: `/etc/ngcp/config/templates/etc/kamailio/proxy/probe.cfg.tt2` is introduced to handle outbound probing requests.

### Database Changes

A new DB column: `provisioning.voip_peer_hosts.probe` with type `TINYINT(1)` (boolean) is added to the DB schema.

A peer status change will populate the `kamailio.dispatcher` table, inserting the SIP URI in format `sip:$ip:$port;transport=$transport` in dispatcher group 100, which defines the probing group for peering servers.

Also the `kamailio.dispatcher.attrs` column is populated with a parameter `peerid=$id`. This ID is used during probing to load the peer preferences: `outbound_socket` and `lbrtp_set`, that are required to properly route the probing request.

## 7.15. Fax Server

There is a Fax Server included in the Sipwise C5. The following sections describe its architecture.

The Fax Server is included on the platform and requires no additional hardware. It supports both T38 and G711 codecs and provides a cost-effective paper-free office solution.

For the details of Fax Server configuration options, please see [Fax Server Configuration](#) chapter in this handbook.

### 7.15.1. Fax2Mail Architecture

To receive faxes via email, a phone call from a sender is connected to the fax application module (Asterisk + Sipwise C5 Fax Server) on Sipwise C5. The received fax document is converted to the format the receiver has configured (either PS, PDF or TIFF) via the components outlined in the figure below. The email is delivered to one or more configured addresses.

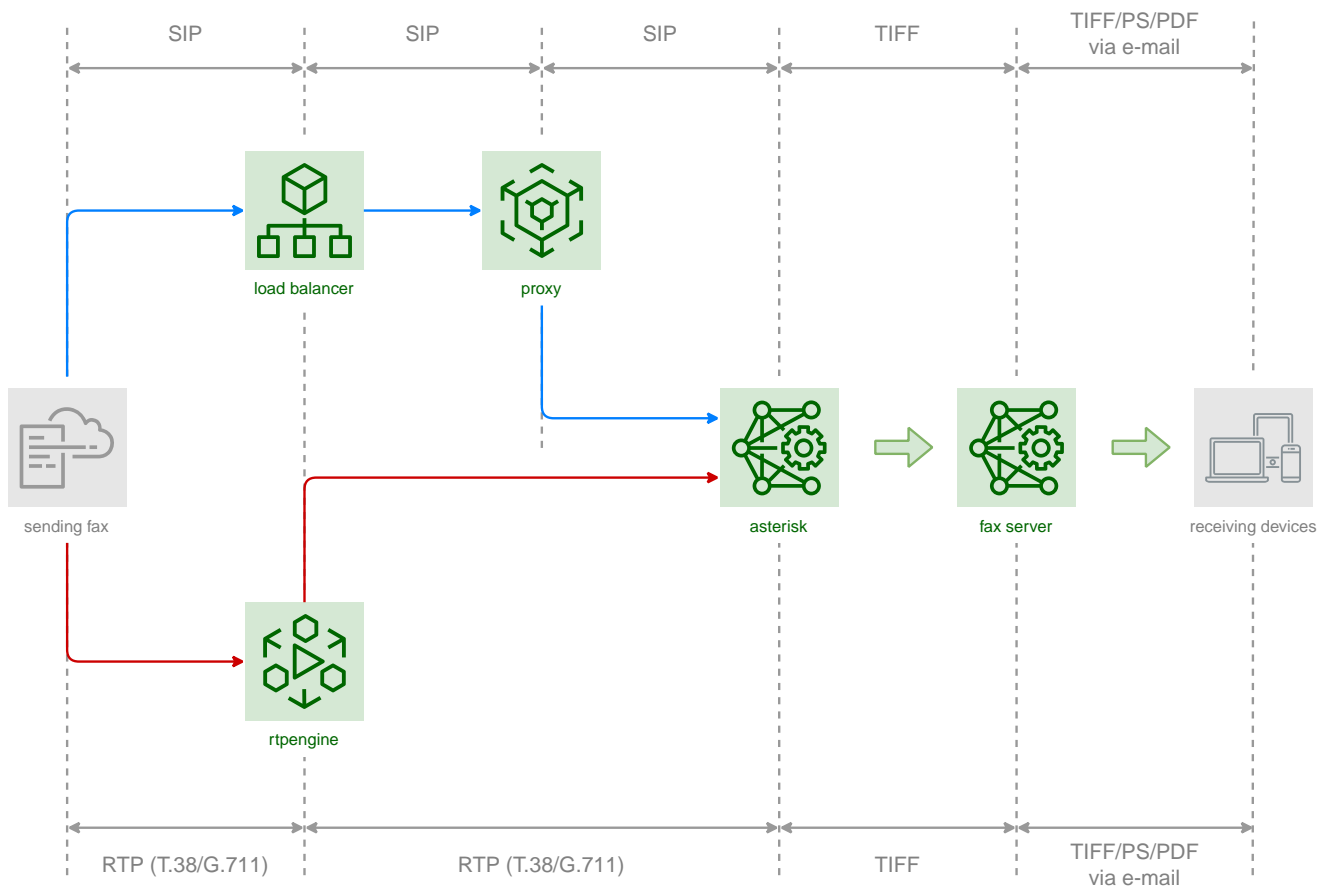

### 7.15.2. Sendfax and Mail2Fax Architecture

To send faxes via Sipwise C5 a sender can use any email client or an interface such as Webfax or REST API.

Currently, supported formats are TXT, PS, TIFF and PDF.

The document is sent to Sipwise C5 Fax Server instance on Sipwise C5 . Once successfully queued by the fax server, it is converted to an internal TIFF format and is sent via the components outlined in the below figure to the specified phone number. A fax device that can receive the document must be connected on the destination side.

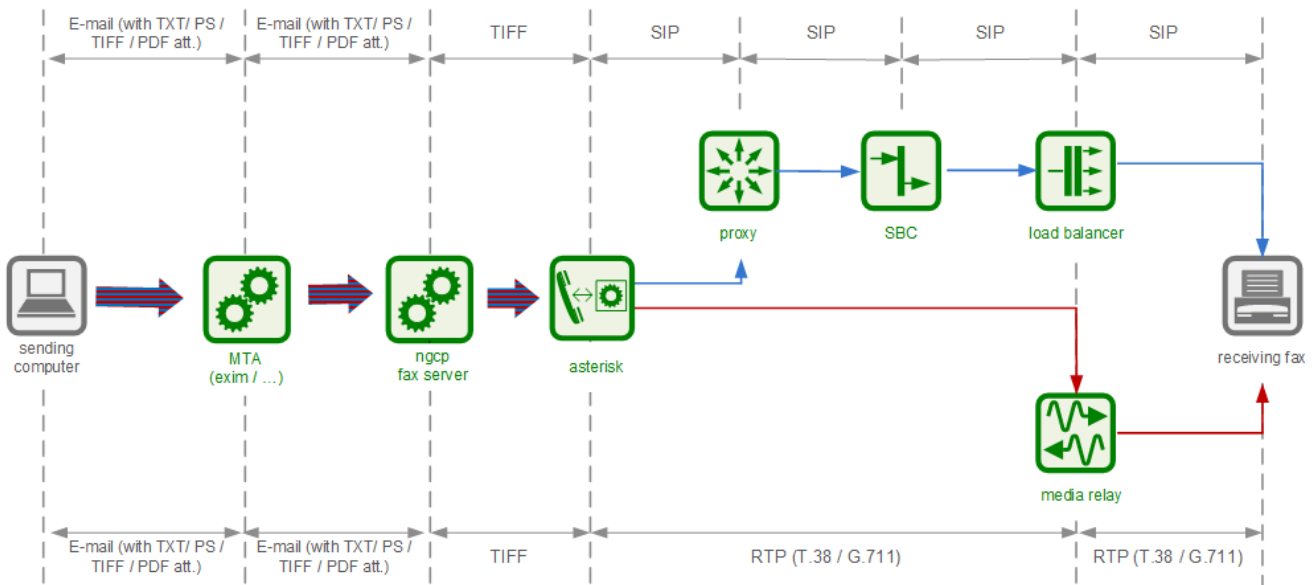

## 7.16. Voicemail System

### 7.16.1. Accessing the IVR Menu

There are three ways to access the voicebox, so that the subscriber can manage their voicebox via the IVR:

1. Call the URI `voicebox@yourdomain` from the subscriber itself, allowing password-less access to the IVR, as the authentication is already done on SIP level.
2. Call the URI `voiceboxpass@yourdomain` from any number, causing the system to prompt for a mailbox and the PIN.
3. Call the URI `voiceboxpin@yourdomain` where only the password/PIN will be requested. The PIN can be set in the *Voicemail and Voicebox* section of the *Subscriber Preferences*.

#### Mapping numbers and codes to IVR access

Since access might need to be provided from external networks like PSTN/Mobile, and since certain SIP phones do not support calling alphanumeric numbers to dial voicebox, you can map any number to the voicebox URIs using rewrite rules.

To do so, you can provision a match pattern e.g. `^(00|\+ )12345$` with a replace pattern `voicebox`, `voiceboxpass` or `voiceboxpin` to map a number to either password-less for the first one or password-based IVR access for the other two. Create a new rewrite rule with the **Inbound** direction and the **Callee** field in the corresponding rewrite rule set.

For inbound calls from external networks, assign this rewrite rule set to the corresponding incoming peer. If you also need to map numbers for on-net calls, assign the rewrite rule set to subscribers or the whole SIP domain.

#### External IVR access

When reaching `voiceboxpass`, the subscriber is prompted for their mailbox number and a password. All numbers assigned to a subscriber are valid input (primary number and any alias number). By default, the required format is in E.164, so the subscriber needs to enter the full number including country code,

for example 4912345 if they got assigned a German number.

While reaching for **voiceboxpin**, the subscriber is only prompted for the PIN.

You can globally configure a rewrite rule in config.yml using asterisk.voicemail.normalize\_match and asterisk.voicemail.normalize\_replace, allowing you to customize the format a subscriber can enter, e.g. having `^0([1-9][0-9]+)$` as match part and `49$1` as replace part to accept German national format.

## 7.16.2. IVR Menu Structure

The following list shows you how the voicebox menu is structured.

- '1' Read voicemail messages
  - '3' Advanced options
    - '3' To Hear messages Envelope
    - "" Return to the main menu
  - '4' Play previous message
  - '5' Repeat current message
  - '6' Play next message
  - '7' Delete current message
  - '9' Save message in a folder
    - '0' Save in new Messages
    - '1' Save in old Messages
    - '2' Save in Work Messages
    - '3' Save in Family Messages
    - '4' Save in Friends Messages
    - '#' Return to the main menu
- '2' Change folders
  - '0' Switch to new Messages
  - '1' Switch to old Messages
  - '2' Switch to Work Messages
  - '3' Switch to Family Messages
  - '4' Switch to Friends Messages
  - '#' Get Back
- '3' Advanced Options
  - "" To return to the main menu
- '0' Mailbox options
  - '1' Record your unavailable message
    - '1' accept it
    - '2' Listen to it

- '3' Rerecord it
- '2' Record your busy message
  - '1' accept it
  - '2' Listen to it
  - '3' Rerecord it
- '3' Record your name
  - '1' accept it
  - '2' Listen to it
  - '3' Rerecord it
- '4' Record your temporary greetings
  - '1' accept it / or re-record if one already exist
  - '2' Listen to it / or delete if one already exist
  - '3' Rerecord it
- '5' Change your password
- "" To return to the main menu
- "" Help
- '#' Exit

### 7.16.3. Type Of Messages

A message/greeting is a short message that plays before the caller is allowed to record a message. The message is intended to let the caller know that you are not able to answer their call. It can also be used to convey other information like when you will be available, other methods to contact you, or other options that the caller can use to receive assistance.

The IVR menu has three types of greetings.

#### Unavailable Message

The standard voice mail greeting is the "unavailable" greeting. This is used if you don't answer the phone and so the call is directed to your voice mailbox.

- You can record a custom unavailable greeting.
- If you have not recorded your unavailable greeting but have recorded your name, the system will play a generic message like: "Recorded name is unavailable."
- If you have not recorded your unavailable greeting, the phone system will play a generic message like: "Digits-of-number-dialed is unavailable".

#### Busy Message

If you wish, you can record a custom greeting used when someone calls you and you are currently on the phone. This is called your "Busy" greeting.

- You can record a custom busy greeting.

- If you have not recorded your busy greeting but have recorded your name, the phone system will play a generic message: "Recorded name is busy."
- If you have not recorded your busy greeting and have not recorded your name (see below), the phone system will play a generic message: "Digits-of-number-dialed is busy."

## Temporary Greeting

You can also record a temporary greeting. If it exists, a temporary greeting will always be played instead of your "busy" or "unavailable" greetings. This could be used, for example, if you are going on vacation or will be out of the office for a while and want to inform people not to expect a return call anytime soon. Using a temporary greeting avoids having to change your normal unavailable greeting when you leave and when you come back.

## 7.16.4. Folders

The Voicemail system allows you to save and organize your messages into folders. There can be up to ten folders.

### The Default Folder List

- 0 - New Messages
- 1 - Old Messages
- 2 - Work Messages
- 3 - Family Messages
- 4 - Friends Messages

When a caller leaves a message for you, the system will put the message into the "New Messages" folder. If you listen to the message, but do not delete the message or save the message to a different folder, it will automatically move the message to the "Old Messages" folder. When you first log into your mailbox, the Voicemail System will make the "New Messages" folder the current folder if you have any new messages. If you do not have any new messages it will make the "Old Messages" folder the current folder.

## 7.16.5. Voicemail Languages Configuration

To add a new language or to change the pronunciation for an existing one, ensure that **mode=new** is defined in `/etc/ngcp-config/templates/etc/asterisk/say.conf.tt2`. Adjust the configuration in the same file using the manual in the beginning. Then, as usual, make the new configuration active.

## 7.16.6. Flowcharts with Voice Prompts

This section shows flowcharts of calls to the voicemail system. Flowcharts contain the name of prompts as they are identified among *Asterisk* voice prompts.

### Listening to New Messages

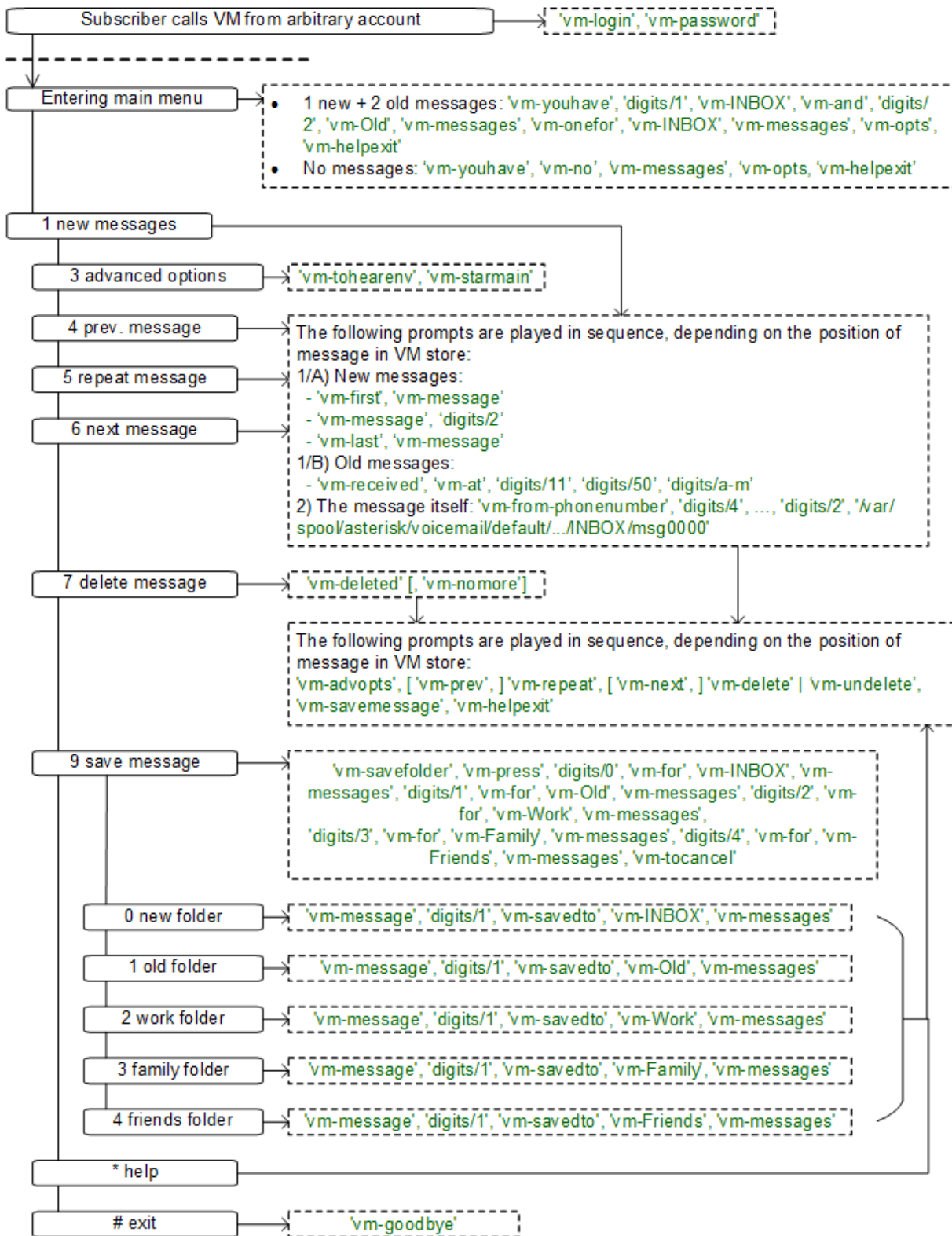

Figure 103. Flowchart of Listening to New Messages

### Changing Voicemail Folders

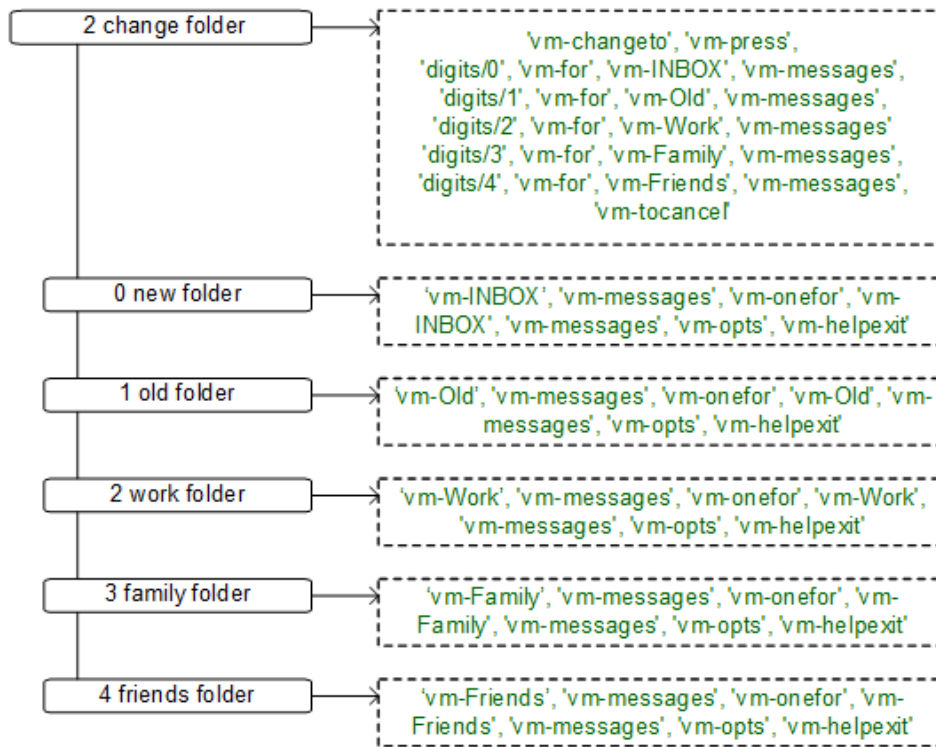

Figure 104. Flowchart of Changing Voicemail Folders

## Mailbox Options

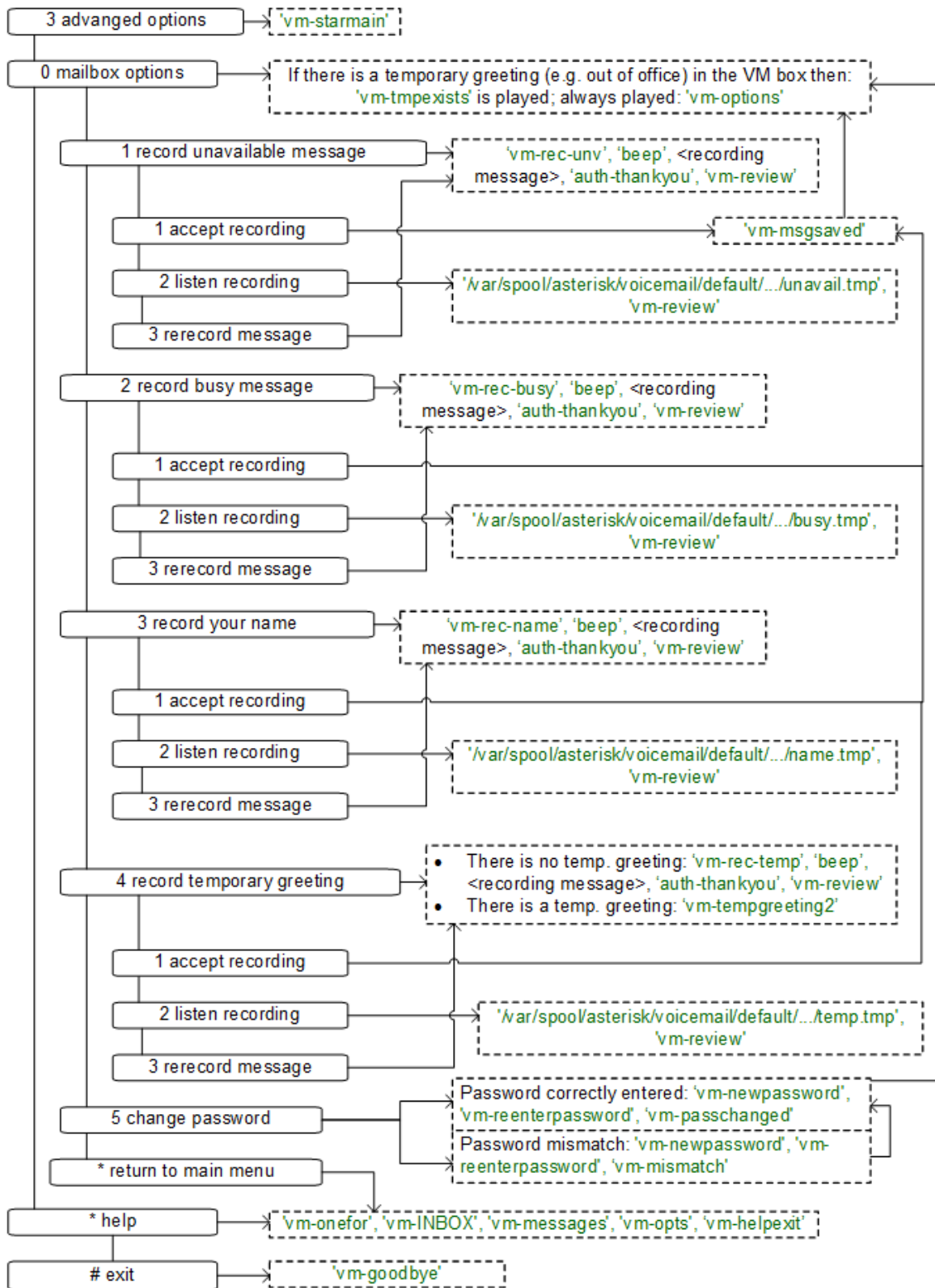

Figure 105. Flowchart of Changing Mailbox Options

### Leaving a Message

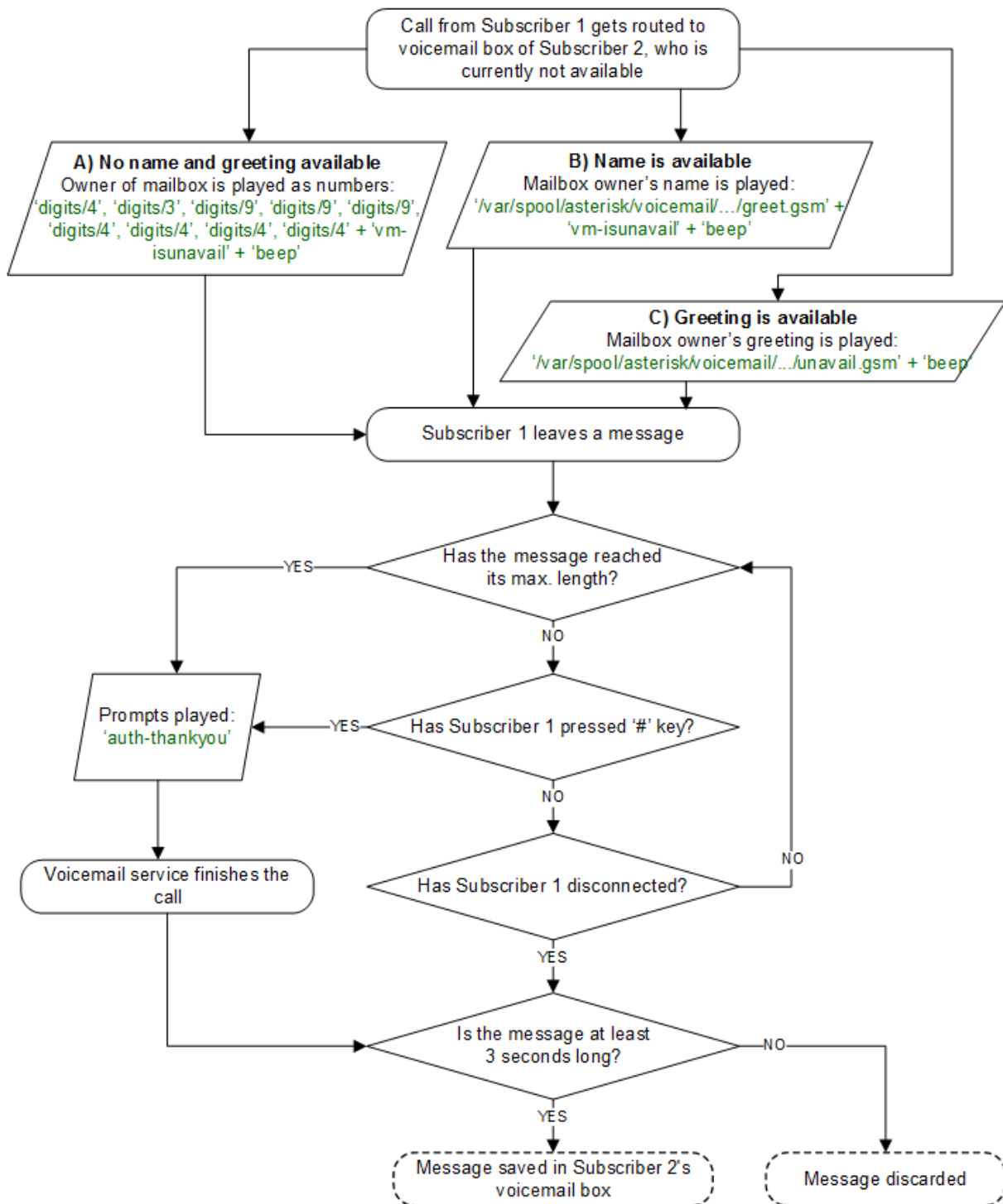

Figure 106. Flowchart of Leaving a Voice Message

## 7.17. Configuring Subscriber IVR Language

The language for the Voicemail system IVR or Vertical Service Codes (VSC) IVRs may be set using the subscriber or domain preference *language*.

Id	Contract	Contact E-Mail	Username	Domain	UUID	Status	Number
544	278	default-customer@default.invalid	demo	sip.yourdomain.com	66462f23-33b3-4ff6-9169-f05cee126479	active	439910001

Subscribers / #544 - demo / Preferences

Setting	Description
header_rule_set	Assign a 'Header Rule Set' to manipulate SIP headers based on dynamic conditions
ip_header	The SIP header to take the IP address for logging it into CDRs.
language	Voice prompts language for voicemail, conference and application server.
last_number_redial	Enable the Vertical Service Code to redial latest dialed number for this subscriber/domain.
lawful_interception	Enables lawful interception for the subscriber.
lcr_peer_cf	If set and a CF to an outbound number is configured on the subscriber, the selection of the outbound peer is done using the forwarder as caller number.
lnp_add_npdi	If enabled, npdi parameter will be added if there is a LNP query.
lnp_for_local_sub	If enabled allows LNP queries for local subscribers.
lnp_to_rn	Defines how to provide the routing number after a LNP query. If enabled, rn parameter will be used.
lookup_all_registrations	By default incoming calls to subscriber's primary number and standard aliases are routed only to devices registered by subscriber's username. Enabling this option allows to route the calls also to endpoints registered as devices (those who use subscriber's alias to register).
mobile_push_enable	Send inbound call to Mobile Push server when called subscriber is not registered. This can not be used together with CFNA as call will be then simply forwarded.
mobile_push_expiry	The expiry interval of sent push request. Client is expected to register within this time, otherwise he should treat the request as outdated and ignore.

The Sipwise C5 offers pre-installed prompts for voicemail in English, Spanish, French and Italian, to name a few, and pre-installed prompts for Vertical Service Codes IVRs in English only.

The other IVRs such as the Conference system and the error announcements use the Sound Sets configured in the Sipwise C5 Panel and uploaded by the administrator in their language of choice.

## 7.18. Sound Sets

The Sipwise C5 provides the administrator with ability to upload the voice prompts such as conference prompts or call error announcements on the *Sound Sets page*.

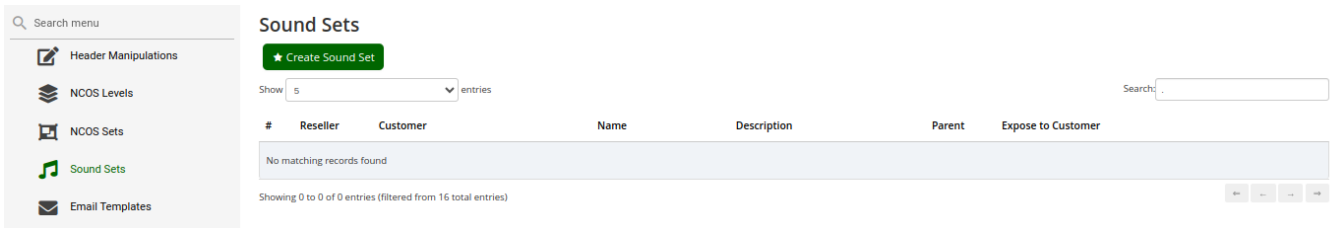

There is a preference *sound\_set* in the *NAT and Media Flow Control* section on Domain and Subscriber levels to link subscribers to the sound set that they should hear (as usual the subscriber preference overrides the domain one).

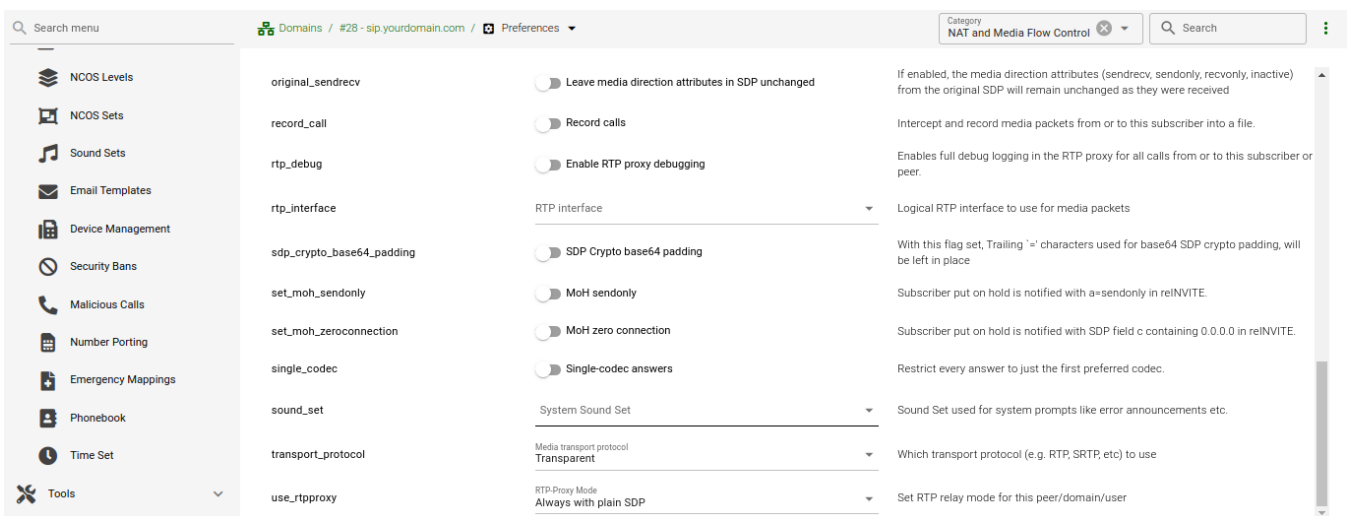

Additionally Sound Sets can be configured on Peer level in order to play a dedicated early reject prompt when an incoming call doesn't match any local subscriber. Sound Sets can be defined in *SettingsSound Sets*. To create a new Sound Set, click *Create Sound Set*. Then click the *Files* button.

### NOTE

As soon as the first audio files (for the sound sets) are uploaded, they will be stored using the SQL backend and will be not available in the filesystem (as usual files). But, as soon as these files are first time played for a caller, they will be stored (cached) in the '/ngcp-data/cache' directory. This is done so in order to reduce the time needed to retrieve them (on a routine basis). Anyway, this data will always be stored in the SQL backend as well for redundancy reasons. So your Sipwise C5 will always be able to retrieve them from SQL and cache them again if needed.

### NOTE

You may use 8 or 16 bit mono WAV audio files for all of the voice prompts.

### 7.18.1. Sound\_Set and Contract\_Sound\_Set Usage

*Sound\_Set* and *Contract\_Sound\_Set* are used for different purposes:

- *Sound\_Set* general soundset that can be assigned by system administrators at domain or subscriber level.
- *Contract\_Sound\_Set* is a customer-specific sound set. It can be assigned only to a PBX customer. It

can be managed also by subscriber administrators through the CSC or API.

Starting from Sipwise C5 version mr11.3.1 the *Contract\_Sound\_Set* has been extended to include all the announcements available in the default *Sound\_Set*. In cases where both types of sound set are assigned to a subscriber, the *Contract\_Sound\_Set* takes precedence.

### 7.18.2. Parent and Soundset Sets inheritance

Every *Sound\_Set* can have a parent *Sound\_Set*. If the parent is configured, all the announcements not defined in the current *Sound\_Set* will be inherited from the parent, if any. The parent *Sound\_Set* can also have a *Sound\_Set* assigned as a parent, producing the "chained" behavior. The Sipwise C5 has an internal check to prevent the creation of a parent inheritance loops. The *Sound\_Set* can be used as a parent from a *Contract\_Sound\_Set* and viceversa.

If a *Sound\_Set* has the *Expose to Customer* flag enabled, it will be visible for subscriber administrators in the CSC panel (and through API), but only in the read-only mode. This allows the subscriber administrators to:

- listen to the currently configured announcements without the possibility to change them
- create a new *Contract\_Sound\_Set* using the exposed *Sound\_Set* as the parent

When a *Sound\_Set* has a parent assigned, there is a new column *Use parent* shown on the UI that enables a choice to use this file (even if empty) or use the parent one (even if not empty). The following table describes the system behavior for different combinations of the *Parent*, *Use Parent* and file presence settings.

Table 13. Sound Sets Inheritance

SoundSet1 (no parent)	SoundSet2 (parent SoundSet1)	SoundSet3 (parent SoundSet2)	Announcement Played
file present	file present	file present	From Soundset3
file present	file present	file present + use parent	From Soundset2
file present	file present + use parent	file present + use parent	From Soundset1
no file	file present + use parent	file present + use parent	No announcement
file present	file present	no file + use parent	From Soundset2
file present	no file + use parent	no file + use parent	From Soundset1
file present	file present	no file	No announcement

When a parent *Sound\_Set* is deleted, the system removes the parent configuration from all *Sound\_Set* that used it as a parent. The same happens in case a *Sound\_Set* is parent of a *Contract\_Sound\_Set* and the *Expose to Customer* flag is disabled afterwards.

### 7.18.3. Configuring Early Reject Sound Sets

The call error announcements are grouped under *Early Rejects* section. Unfold the section and click *Edit* next to the sound handles (Names) that you want to use. Choose a WAV file from your file system, and tick the Loopplay setting if you want to play the file in a loop instead of only once. Click Save to upload the file.

**Manage Sound Set ddd**

calling\_card  
conference  
custom\_announcements  
digits  
early\_media  
early\_rejects

Name	Filename	Loop
block_in		<input type="checkbox"/>
block_ncos		<input type="checkbox"/>
block_out		<input type="checkbox"/>
block_override_pin_wrong		<input type="checkbox"/>
callee_busy		<input type="checkbox"/>

The call error announcements are played to the user in early media hence the name "Early Reject". If you do not provide the sound files for any handles they will not be used and the Sipwise C5 will fallback to sending the error response code back to the user.

The exact error status code and text are configurable in the `/etc/ngcp-config/config.yml` file, in `kamailio.proxy.early_rejects` section. Please look for the announcement handle listed in below table in order to find it in the configuration file.

Table 14. Early Reject Announcements

Handle	Description	Message played
<code>block_in</code>	This is what the calling party hears when a call is made from a number that is blocked by the incoming block list ( <code>adm_block_in_list</code> , <code>block_in_list</code> customer/subscriber preferences)	Your call is blocked by the number you are trying to reach.
<code>block_out</code>	This is what the calling party hears when a call is made to a number that is blocked by the outgoing block list ( <code>adm_block_out_list</code> , <code>block_out_list</code> customer/subscriber preferences)	Your call to the number you are trying to reach is blocked.
<code>block_ncos</code>	This is what the calling party hears when a call is made to a number that is blocked by the NCOS level assigned to the subscriber or domain (the NCOS level chosen in <code>ncos</code> and <code>adm_ncos</code> preferences). <i>PLEASE NOTE:</i> It is not possible to configure the status code and text.	Your call to the number you are trying to reach is not permitted.

Handle	Description	Message played
<code>block_override_pin_wrong</code>	Announcement played to calling party if it used wrong PIN code to override the outgoing user block list or the NCOS level for this call (the PIN set by <i>block_out_override_pin</i> and <i>adm_block_out_override_pin</i> preferences)	The PIN code you have entered is not correct.
<code>callee_busy</code>	Announcement played on incoming call to the subscriber which is currently busy (486 response from the UAS)	The number you are trying to reach is currently busy. Please try again later.
<code>callee_offline</code>	Announcement played on incoming call to the subscriber which is currently not registered	The number you are trying to reach is currently not available. Please try again later.
<code>callee_tmp_unavailable</code>	Announcement played on incoming call to the subscriber which is currently unavailable (408, other 4xx or no response code or 30x with malformed contact)	The number you are trying to reach is currently not available. Please try again later.
<code>callee_unknown</code>	Announcement that is played on call to unknown or invalid number (not associated with any of our subscribers/hunt groups)	The number you are trying to reach is not in use.
<code>callee_dnd</code>	Announcement that is played on call to a subscriber that the the DND preference set	The number you are trying to reach is currently not accepting calls. Please try again later.
<code>cf_loop</code>	Announcement played when the called subscriber has the call forwarding configured to itself	The number you are trying to reach is forwarded to an invalid destination.
<code>emergency_geo_unavailable</code>	Announcement played when emergency destination is dialed but the destination is not provisioned for the location of the user. <i>PLEASE NOTE:</i> The configuration entry for this case in <code>/etc/ngcp-config/config.yml</code> file is <code>emergency_invalid</code> .	The emergency number you have dialed is not available in your region.

Handle	Description	Message played
<code>emergency_unsupported</code>	Announcement played when emergency destination is dialed but the emergency calls are administratively prohibited for this user or domain ( <i>reject_emergency</i> preference is enabled)	You are not allowed to place emergency calls from this line. Please use a different phone.
<code>error_please_try_later</code>	Announcement played when was an error during call processing. <i>PLEASE NOTE:</i> This announcement may be configured in the sound set in <i>voucher_recharge</i> section.	An error has occurred. Please try again later.
<code>invalid_speeddial</code>	This is what the calling party hears when it calls an empty speed-dial slot	The speed dial slot you are trying to use is not available.
<code>locked_in</code>	Announcement played on incoming call to a subscriber that is locked for incoming calls	The number you are trying to reach is currently not permitted to receive calls.
<code>locked_out</code>	Announcement played on outgoing call to subscriber that is locked for outgoing calls	You are currently not allowed to place outbound calls.
<code>max_calls_in</code>	Announcement played on incoming call to a subscriber who has exceeded the <i>concurrent_max</i> or <i>concurrent_max_in</i> limit or whose customer has exceeded the <i>concurrent_max_per_account</i> or <i>concurrent_max_in_per_account</i> limit calls	The number you are trying to reach is currently busy. Please try again later.
<code>max_calls_out</code>	Announcement played on outgoing call to a subscriber who has exceeded the <i>concurrent_max</i> (total limit) or <i>concurrent_max_out</i> (limit on number of outbound calls) or whose customer has exceeded the <i>concurrent_max_per_account</i> or <i>concurrent_max_out_per_account</i> limit	All outgoing lines are currently in use. Please try again later.
<code>max_calls_peer</code>	Announcement played on calls from the peering if that peer has reached the maximum number of concurrent calls (configured by admin in <i>concurrent_max</i> preference of peering server). <i>PLEASE NOTE:</i> There is no configuration option of the status code and text in <i>config.yml</i> file for this case.	The network you are trying to reach is currently busy. Please try again later.

Handle	Description	Message played
<code>no_credit</code>	Announcement played when prepaid account has insufficient balance to make a call to this destination	You don't have sufficient credit balance for the number you are trying to reach.
<code>peering_unavailable</code>	Announcement played in case of outgoing off-net call when there is no peering rule matching this destination and/or source	The network you are trying to reach is not available.
<code>reject_vsc</code>	When the VSC (Vertical Service Code) service is disabled in domain or subscriber preferences (Access Restrictions / <code>reject_vsc</code> is set to TRUE) and a subscriber tries to make a call with VSC, an announcement is played.	N/A (custom message, no default)
<code>relaying_denied</code>	Announcement played on inbound call from trusted IP (e.g. external PBX) with non-local Request-URI domain	The network you are trying to reach is not available.
<code>unauth_caller_ip</code>	This is what the calling party hears when it tries to make a call from unauthorized IP address or network ( <code>allowed_ips</code> preferences)	You are not allowed to place calls from your current network location.

There are some early reject scenarios when either **no voice announcement is played, or a fixed announcement is played**. In either case a SIP error status message is sent from Sipwise C5 to the calling party. It is possible to configure the exact status code and text for such cases in the `/etc/ngcp-config/config.yml` file, in `kamailio.proxy.early_rejects` section. The below table gives an overview of those early reject cases.

Table 15. Additional Early Reject Reason Codes

Handle	Description
<code>block_admin</code>	Caller blocked by <code>adm_block_in_list</code> , <code>adm_block_in_clir</code> and callee blocked by <code>adm_block_out_list</code> (customer or subscriber preference)
<code>block_callee</code>	Callee blocked by subscriber preference <code>block_out_list</code>
<code>block_caller</code>	Caller blocked by subscriber preference <code>block_in_list</code> , <code>block_in_clir</code>
<code>block_contract</code>	Caller blocked by customer preference <code>block_in_list</code> , <code>block_in_clir</code> and callee blocked by customer preference <code>block_out_list</code>

Handle	Description
<code>callee_tmp_unavailable_gp</code>	Callee is a PBX group with 0 members. Announcement <code>callee_tmp_unavailable</code> is played; status code and text can be configured.
<code>callee_tmp_unavailable_tm</code>	Callee is a PBX group and we have a timeout (i.e. no group member could be reached). Announcement <code>callee_tmp_unavailable</code> is played; status code and text can be configured.
<code>emergency_invalid</code>	<i>PLEASE NOTE:</i> This handle refers to the same early reject case as <code>emergency_geo_unavailable</code> , but is labeled differently in the configuration file.

By default the Early Reject sounds are being played using early media, so after the 183 Session Progress message. Using the subscriber's preference `announce_conn_type` this behavior can be changed.

If `announce_conn_type` is set to "Early" (default value), the behavior does not change. If `announce_conn_type` is set to "Established" the prompt will be played with an established media (200 OK).

This can help such scenario where 183 cannot be properly handled by the caller side.

Furthermore, changing of this preference will affect a behavior of all pre-announcement based applications for this subscriber, such as:

- **Office-Hours:** [Office-Hours](#)
- **Pre-Recording Announcement:** [Pre-Recording Announcement](#)
- **Early-Reject Announcement:** [Configuring Early Reject Sound Sets](#)
- **Any other type of pre announcements**

This preference has two levels of setting:

- **Domain level**
- **Subscriber level**

In case it's set per domain level and a subscriber has a value set to 'use domain default', the value for this preference will be then inherited from the domain one.

#### 7.18.4. Play an announcement on behalf of callee server failure in case of outbound calls

The Sipwise C5 makes it possible to play an announcement on behalf of callee server failure in case of outbound calls. The features can be activated on Subscribers and on Peers. For example: if subscriber A calls subscriber B, but subscriber B refuses the call with code 404 without providing any announcement, the Sipwise C5 can be configured to play a customized announcement to subscriber A

on behalf of subscriber B.

To activate this feature, first create a system *Sound Set*, or use an already existing one, and then assign it to the callee subscriber. Upload in the *Sound Set* one or more announcements. Once the *Sound Set* is configured, the subscriber's preference *announce\_error\_codes\_enable* must be enabled under *Subscriber Preferences NAT and Media Flow Control* menu. Last step is to list in the subscriber's preference *announce\_error\_codes\_list* the announcements that will be played to the caller in case a particular error code is returned back from the callee. Each entry of the list has to be a string composed in the following way: `<error_code>;<announcement_name>`, where *error\_code* is the SIP return code and *announcement\_name* is name of the announcement taken from the *sound\_set* list. Returning to the example above, to play *callee\_unknown* message in case of *404* returned from the callee, the entry `'404;callee_unknown'` has to be added in *announce\_error\_codes\_list* preference.

The same feature is available for peer as well.

### IMPORTANT

In case *announce\_error\_codes\_enable* is enabled, it is important that the remote endpoint does not play any announcement for error codes listed in *announce\_error\_codes\_list* otherwise the final result will be to have two announcements: one generated by the remote endpoint and one generated by the Sipwise C5.

## 7.19. Conference System

The Sipwise C5 provides the simple pin-protected conferencing service built using the SEMS DSM scripting language. Hence it is open for all kinds of modifications and extensions.

Template files for the sems conference scripts stored in `/etc/ngcp-config/templates/etc/sems-b2b/`:

- IVR script: `/etc/ngcp-config/templates/etc/sems-b2b/dsm/confpin.dsm.tt2`
- Config: `/etc/ngcp-config/templates/etc/sems-b2b/dsm/confpin.conf.tt2`

### 7.19.1. Configuring Call Forward to Conference

Go to your *Subscriber Details*, then *Call Forwarding* and click *Edit* on the Call Forward Type you want to set (e.g. *Call Forward Unconditional*).

Type	Answer Timeout	Timeset	Sources	To (B-Numbers)	New Destinations	Enabled
Call Forward Unconditional		always	all sources	any number	4312345@sip.yourdomain.com for 300s	1 <span>Edit</span> <span>Delete</span>
Call Forward Busy						
Call Forward Timeout						
Call Forward Unavailable						
Call Forward SMS						
Call Forward on Response						
Call Forward on Overflow						

You should select *Conference* option in the *Destination* field and leave the *URI/Number* empty. The timeout defines for how long this destination should be tried to ring.

### 7.19.2. Configuring Conference Sound Sets

Sound Sets can be defined in *SettingsSound Sets*. To create a new Sound Set, click *Create Sound Set*. Then click the *Files* button.

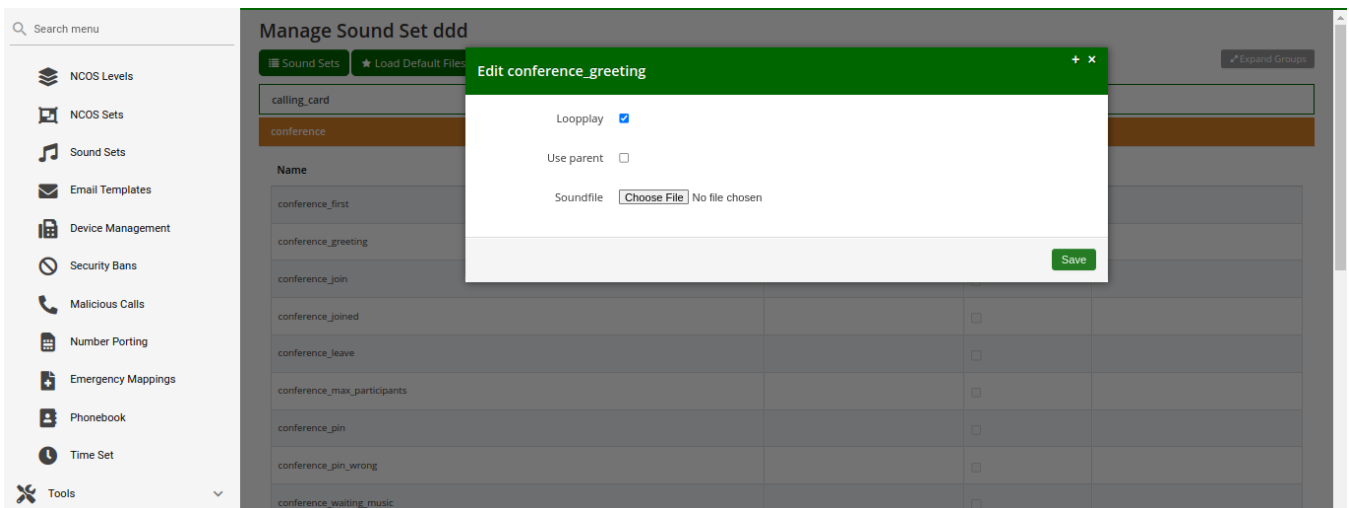
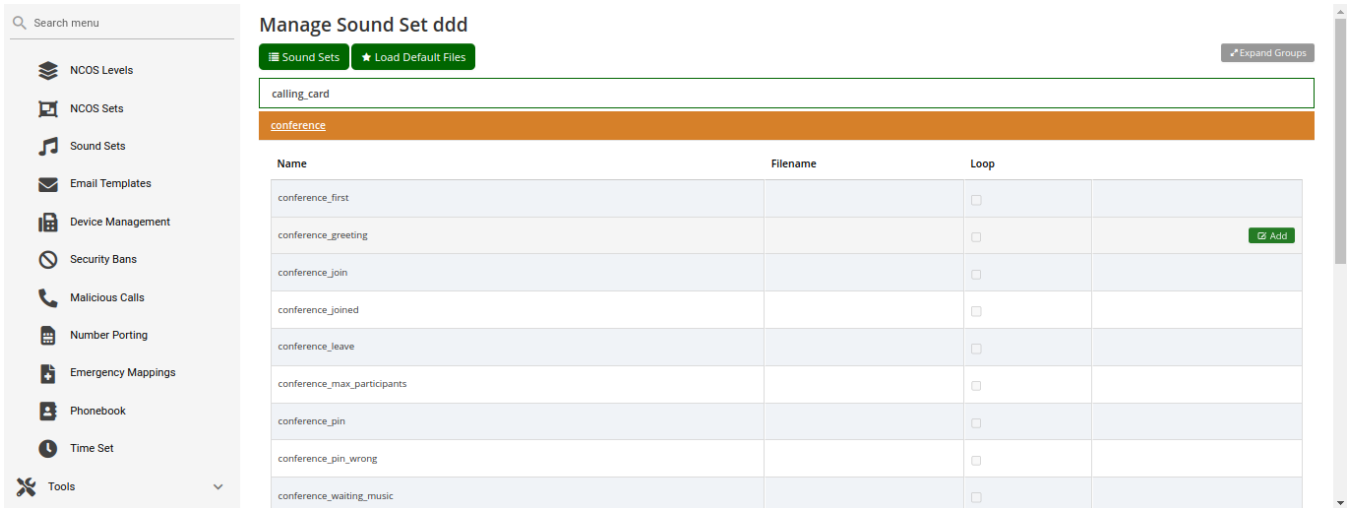
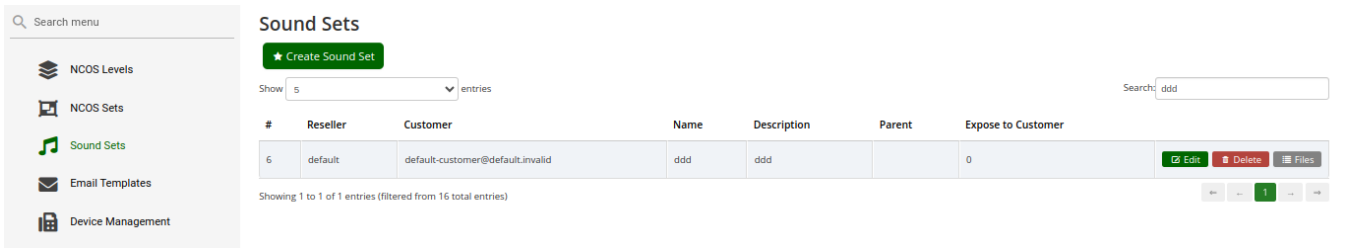

Upload the following files:

Table 16. Conference Sound Sets

Handle	Message played
conference_greeting	Welcome to the conferencing service.
conference_pin	Please enter your PIN, followed by the pound key.
conference_pin_wrong	You have entered an invalid PIN number. Please try again.
conference_joined	You will be placed into the conference.
conference_first	You are the first person in the conference.
conference_join	A person has joined the conference.

Handle	Message played
conference_leave	A person has left the conference.
conference_max_participants	All conference lines are currently in use. Please try again later.
conference_waiting_music	...waiting music...
goodbye	Goodbye.

**NOTE** | You may use 8 or 16 bit mono WAV audio files.

Then set the preference *sound\_set* on the Domain or Subscriber level in order to assign the Sound Set you have just created to the subscriber (as usual the subscriber preference overrides the domain one).

### 7.19.3. Joining the Conference

There are 2 ways of joining a conference: with or without PIN code. The actual way of joining the conference depends on *Subscriber* settings. A subscriber who has activated the conference through call forwarding may set a PIN in order to protect the conference from unauthorized access. To activate the PIN one has to enter a value in *Subscriber Preferences Internals conference\_pin* field.

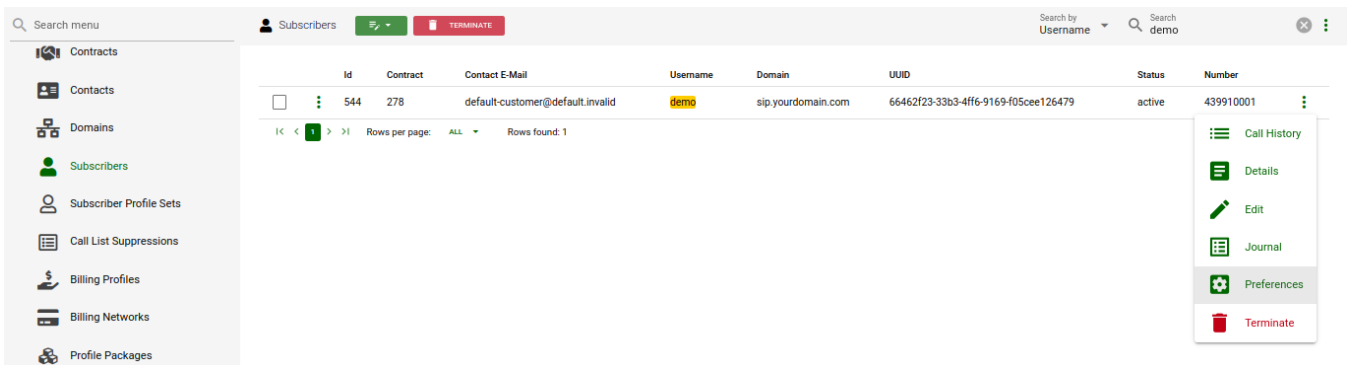

Figure 107. Subscriber Preferences

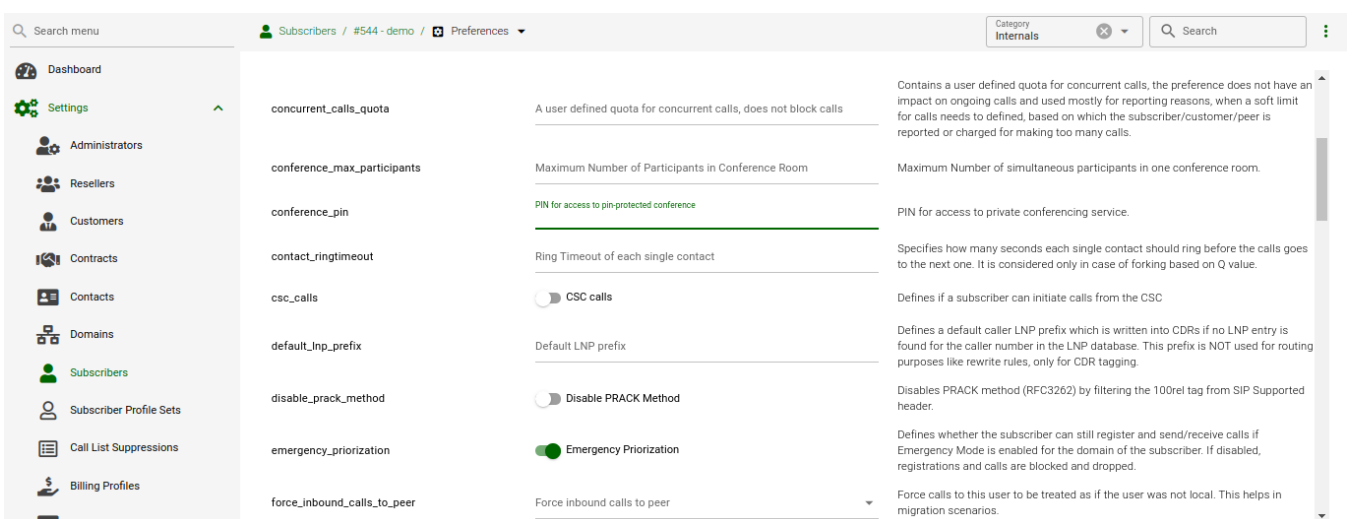

Figure 108. Setting Conference PIN

In case the PIN protection for the conference is activated, when someone calls the subscriber who has

enabled the conference, the caller is prompted to enter the PIN of the conference. Upon the successful entry of the PIN the caller hears the announcement that he is going to be placed into the conference and at the same time this is announced to all participants already in the conference.

#### 7.19.4. Conference Flowchart with Voice Prompts

The following 2 sections show flowcharts with voice prompts that are played to a caller when they dial the conference.

##### Conference Flowchart with PIN Validation

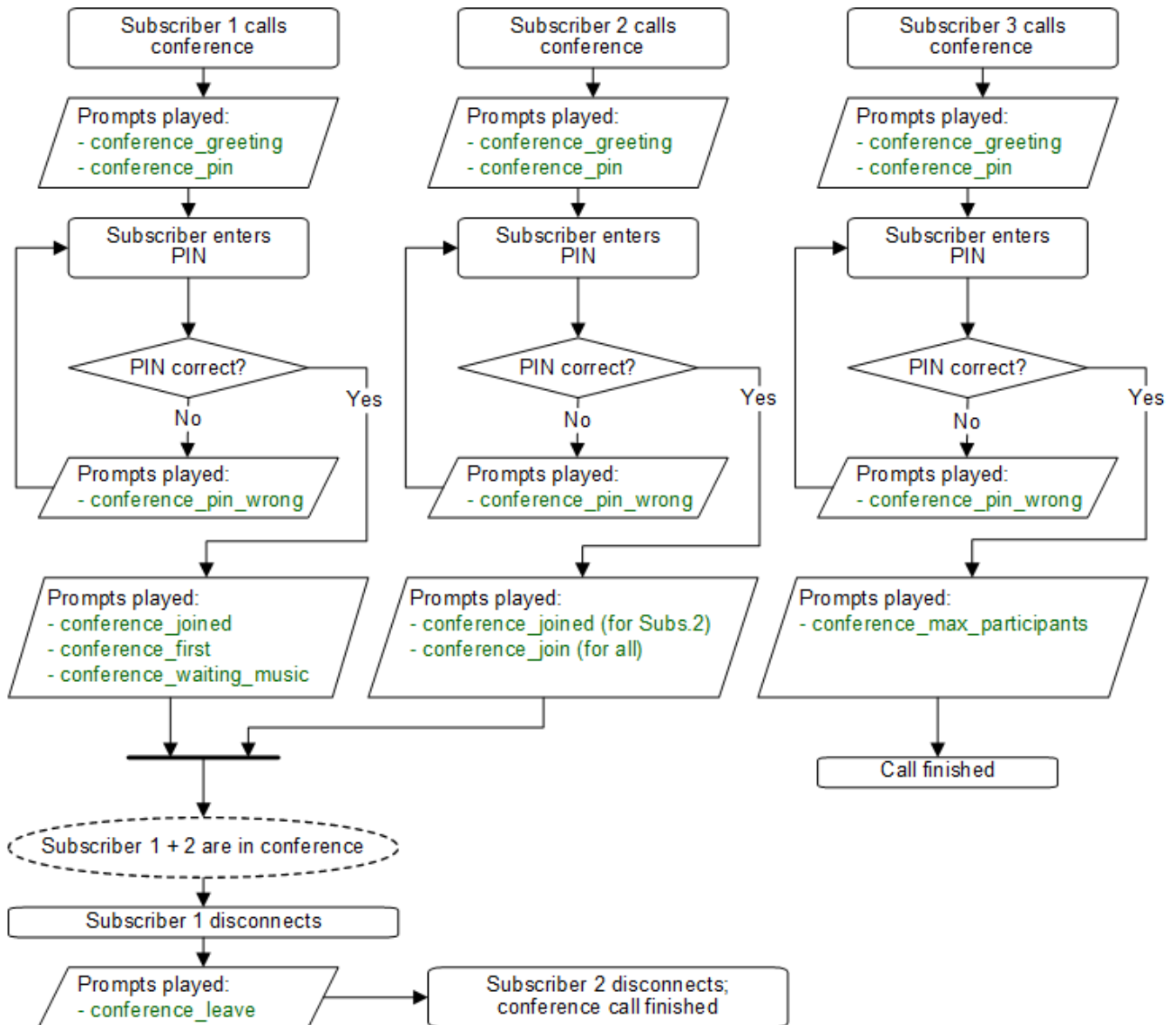

Figure 109. Flowchart of Conference with PIN Validation

##### Conference Flowchart without PIN

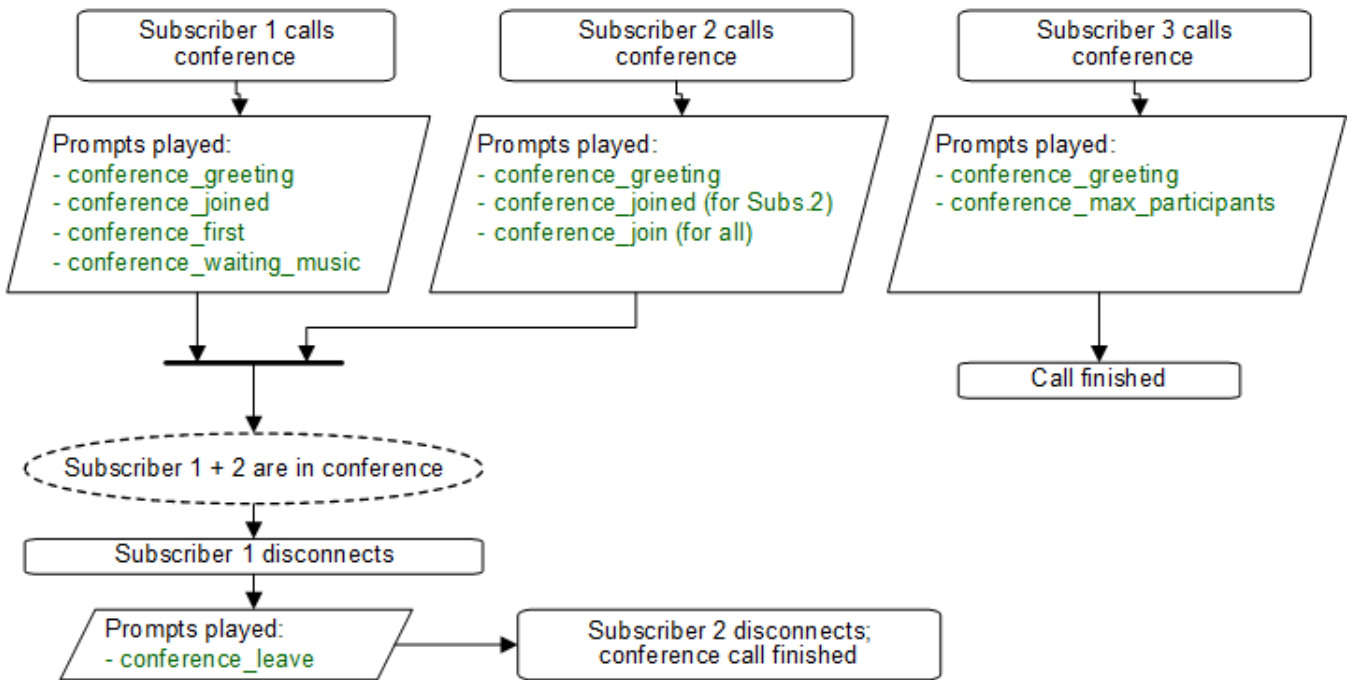

Figure 110. Flowchart of Conference without PIN

## 7.20. Malicious Call Identification (MCID)

The MCID feature allows customers to report unwanted calls to the platform operator.

### 7.20.1. Setup

To enable the feature first edit `config.yml` and enable there apps: `malicious_call: yes` and `kamailio: store_recentcalls: yes`. The latter option enables kamailio to store recent calls per subscriber UUID in the redis DB (the amount of stored recent calls will not exceed the amount of provisioned subscribers).

Next step is to create a system sound set for the feature. In *SettingsSound Sets* either use your already existing *Sound Set* or create a new *Sound Set* and then assign it to your domain or subscribers. In the *Sound Set* there is a fileset `malicious_call_identification` for that purpose.

Once the *Sound Set* is created, the Subscriber's Preferences *Malicious Call Identification* must be enabled under *Subscribers Preferences Applications malicious\_call\_identification*. The same parameter can be set in the Customer's preferences to enable this feature for all its subscribers.

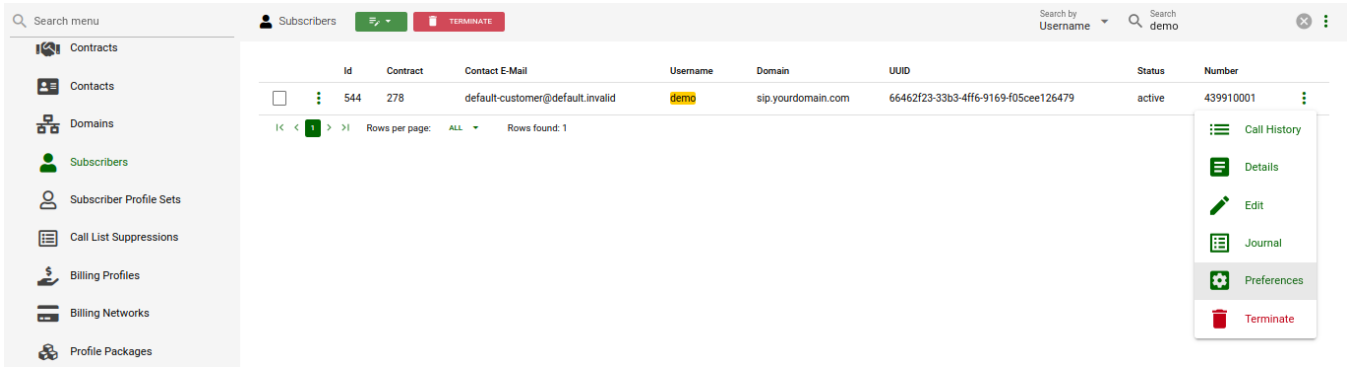

Figure 111. Subscriber Preferences

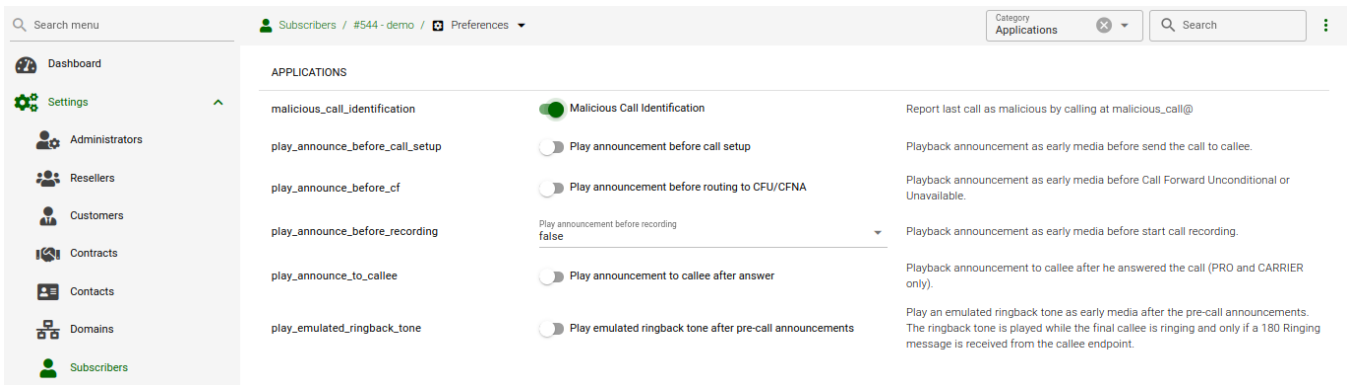

Figure 112. Set Malicious Call Identification

The final step is to create a new *Rewrite Rule* and to route calls to, for instance `*123 -> MCID` application. For that you create a *Callee Inbound* rewrite rule `^\(\*123\)$ malicious_call`

Finally, run `ngcpcfg apply "Enabling MCID"` to recreate the templates and automatically restart depended services.

### 7.20.2. Usage

For a subscriber to report a malicious call, they can either call *malicious\_call* or to their custom number assigned for that purpose. Please note that you can only report your last received call. You will hear the media reply from the *Sound Set* you have previously configured.

To check reported malicious calls as the platform operator open *SettingsMalicious Calls* tab where you will see a list of registered calls. You can selectively delete records from the list and alternatively you can manage the reported calls by using the REST API.

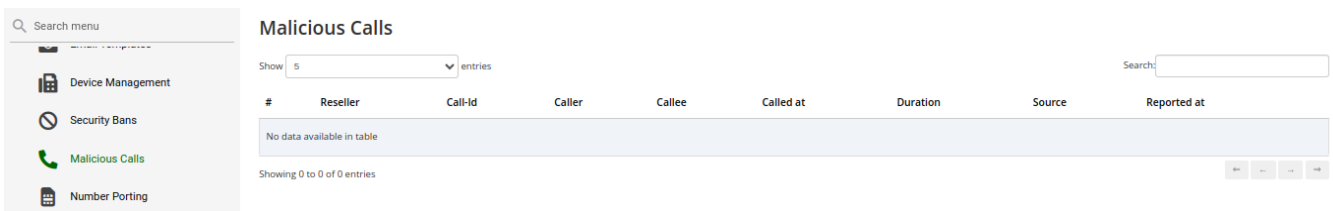

Figure 113. Malicious Calls

## 7.21. Subscriber Profiles

The preferences a subscriber can provision by themselves via the CSC can be limited via profiles within profile sets assigned to subscribers.

### 7.21.1. Subscriber Profile Sets

Profile sets define containers for profiles. The idea is to define profile sets with different profiles by the administrator (or the reseller, if they are permitted to do so). Then, a subscriber with administrative privileges can re-assign profiles within their profile sets for the subscribers of their customer account.

Profile Sets can be defined in *SettingsSubscriber Profiles*. To create a new Profile Set, click *Add*.

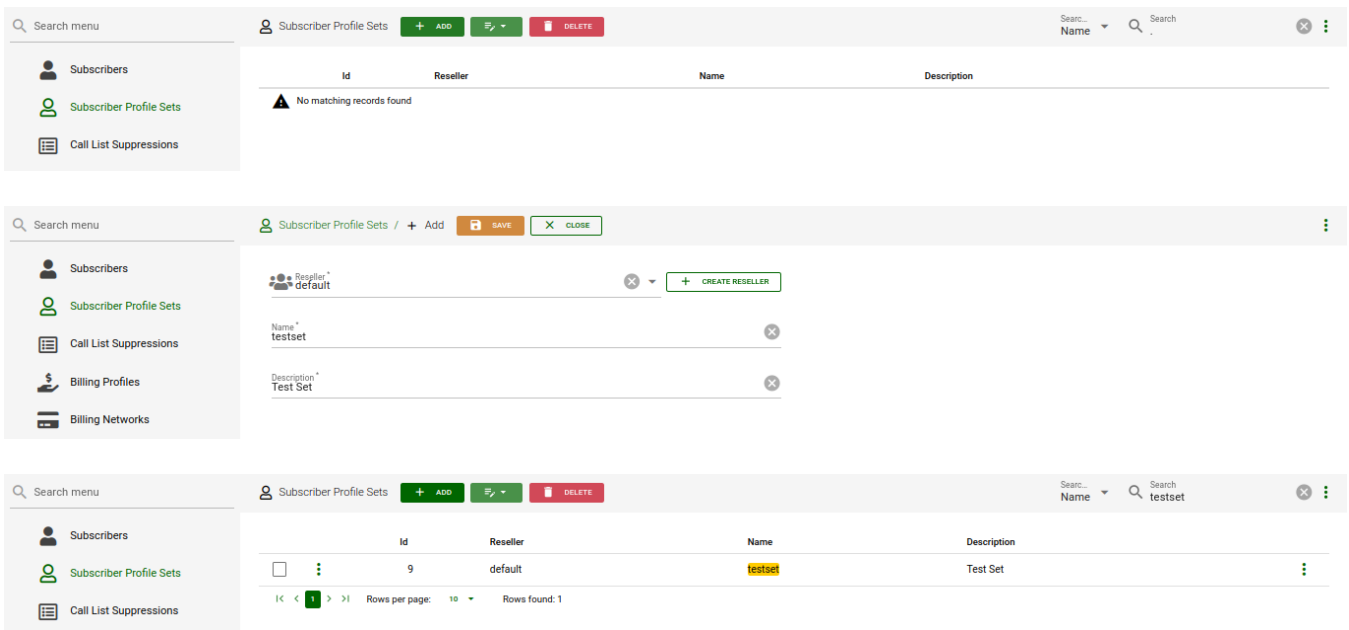

You need to provide a reseller, name and description.

To create Profiles within a Profile Set, hover over the Profile Set and click the *Profiles* button.

Profiles within a Profile Set can be created by clicking the *Create Subscriber Profile* button.

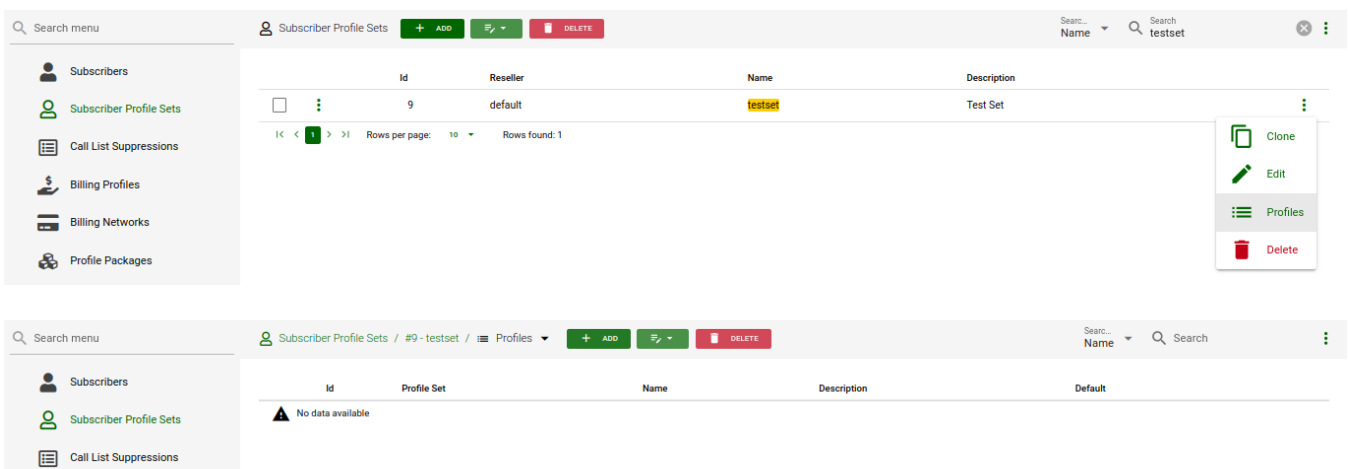

The screenshot displays the configuration page for a Subscriber Profile Set named 'test'. The interface includes a sidebar with navigation options and a main content area with various toggle switches and buttons for managing profile flags. Below the configuration area, a table lists the profile sets.

Id	Profile Set	Name	Description	Default
13	testset	test	Test Profile	<input checked="" type="checkbox"/>

Checking the *Default Profile* option causes this profile to get assigned automatically to all subscribers, who have the profile set assigned. All the other subsequent flags define the user preferences which should be made available to the subscriber in the personal CSC.

When the platform administrator selects *Preferences* of the Subscriber Profile they will get the list of preferences that can be set by default for all subscribers who have this profile assigned. For example, if the system administrator configures the *ncos* (NCOS level) preference in the profile, this NCOS will be assigned by default to all the subscribers who use that profile.

#### NOTE

Profile Preferences take precedence over the Domain preferences, but Profile Preferences holds a lower priority compared the Subscribers Preferences.

#### NOTE

The Subscribers Profiles can be created prior creating any subscriber.

## 7.22. SIP Loop Detection

In order to detect a SIP loop (incoming call as a response for a call request) the Sipwise C5 checks the combination of *SIP-URI*, *To* and *From* headers.

This check can be enabled in *config.yml* by setting `kamailio.proxy.loop_detection.enable: yes`. The system tolerates `kamailio.proxy.loop_detection.max` loops within `kamailio.proxy.loop_detection.expire` seconds. Higher occurrence of loops will be reported with a SIP 482 "Loop Detected" error message

## 7.23. Call-Through Application

Call-through allows a telephony client to dial into an IVR system and specify (in a two-stage dialing fashion) a new destination number which is then dialed by the Sipwise C5 to connect the client to the destination. As the call-through system needs to be protected from unauthorized use, a list of CLIs which are allowed to use the call-through system is stored in the Sipwise C5 platform.

Table 17. Call-Through Mappings

Column	Description
uuid	The internal UUID of the call-through subscriber
auth_key	Authentication key (CLI)
source_uuid	The internal UUID of the subscriber that is authorized for outgoing call leg (same as uuid in call-through scenario)

### 7.23.1. Activation

The service is installed on every Sipwise C5 system, but is not activated by default. In order to activate the service, set the value '1' to the `callthru_features` option under the `www_admin` section of the `config.yml` configuration file, then execute:

```
ngcpcfg set /etc/ngcp-config/config.yml www_admin.callthru_features='1'
ngcpcfg apply 'Enabled call-through'
ngcpcfg push all
```

### 7.23.2. Administrative Configuration

#### Subscriber provisioning

In order to manage the call-through CLIs for subscriber, navigate to *SettingsSubscribers*, search for the subscriber you want to edit, press *Details Callthrough CLIs* section and press *Edit*.

Id	Contract	Contact E-Mail	Username	Domain	UUID	Status	Number
544	278	default-customer@default.invalid	demo	sip.yourdomain.com	66462f23-33b3-4ff6-9169-f05cee126479	active	439910001

Id	CLI	Source UUID
No data available		

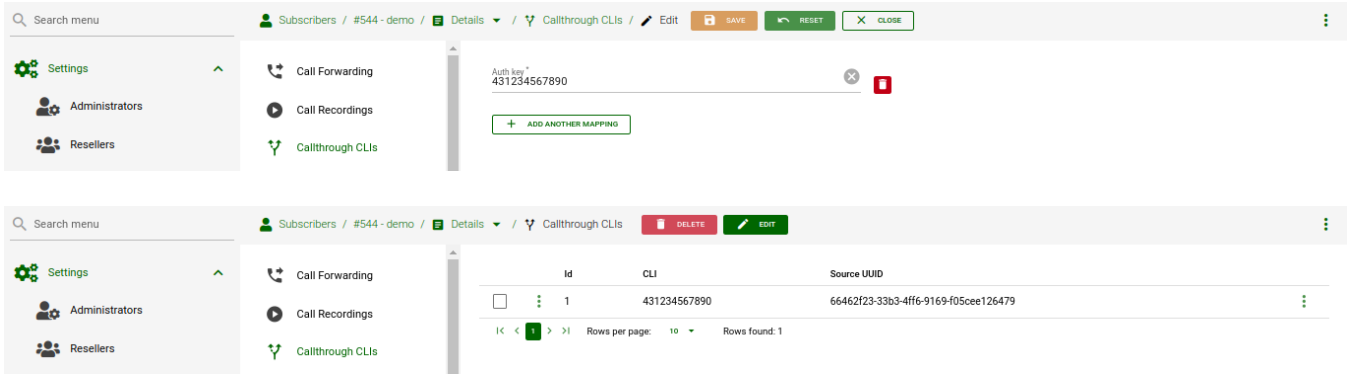

**NOTE**

If the subscriber has set up a Call Forward to the call-through application, but the caller's CLI is not in the authorized CLIs list for call-through, sems responds with an error back to the proxy and the proxy advances to the next number in the Call Forward destinations set.

**Sound Set provisioning**

In order for the Call-through application to work, a Sound Set must be created and associated with the Domain or Subscriber.

Sound Sets can be defined in *SettingsSound Sets*. To create a new Sound Set, click *Create Sound Set*, then click the *Files* button. An administrator can upload the default sounds in one of supported languages or uploaded by the administrator manually in their language of choice.

There is a preference *sound\_set* on Domain and Subscriber levels to link subscribers to the sound set that they should hear (as usual the subscriber preference overrides the domain one).



**Manage Sound Set ddd**

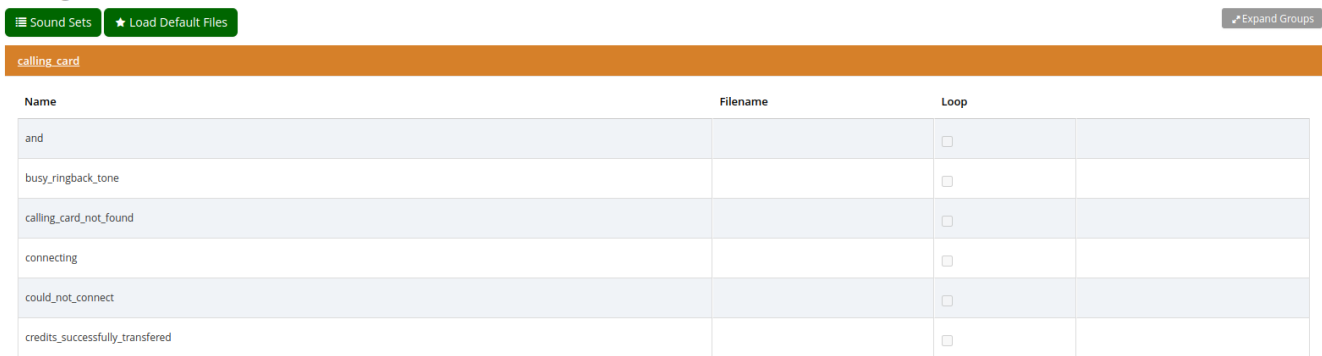

**NOTE**

You may use 8 or 16 bit mono WAV audio files for all of the voice prompts.

### 7.23.3. Call Flow

The call arrives at sems application server with Request-URI user callthrough.

#### Internal Header Parameters

The INVITE contains an extra SIP header P-App-Param with the following parameters:

*Table 18. SIP Header parameters for call-through application*

Name	Meaning
uuid	The internal UUID of the call-through subscriber
srcnumber	Caller's CLI for the authentication
outgoing_cli	New CLI to be used by sems application for the outgoing call leg

#### Caller authorization

Caller is authorized using mapping shown in table above: select source\_uuid from provisioning.voip\_cc\_mappings where uuid=\$uuid and auth\_key=\$srcnumber;

If the check fails return the configured error response code. Then proceed with the call setup as follows.

#### Outgoing call

Sems requests the user to enter destination and starts digit collection. Digit collection process is terminated after 5 seconds (configurable in sems config file) or by pressing the '#' key. The user can start entering the destination while the voice prompt is being played.

Sems sends INVITE to the proxy with Request-URI: sip:\$number@\$outboundproxy;sw\_domain=\$subscriber.domain

From: \$outgoing\_cli

On receiving the 401 or 407 response from the proxy the application authenticates using the digest credentials retrieved for the call-through subscriber from the voip\_subscribers table:select s.username, s.password, d.domain from provisioning.voip\_subscribers s, provisioning.voip\_domains d where s.uuid=\$source\_uuid and s.domain\_id=d.id;

If the call setup fails the application plays back the "could\_not\_connect" sound file. If successful the application acts transparently and does not provide any voice announcements or DTMF detection.

#### CLI configuration

The CLI on the outgoing call from the call-through module is set to the Network-Provided Number (NPN) of the call-through subscriber. There is nothing to configure.

## 7.24. Calling Card Application

The calling card application uses a similar concept to call-through except that authorization process operates on the PIN code entered by user using DTMF instead of the CLI. The Sipwise C5 maps incoming UUID of the pilot subscriber to the list of PINs for calling card application with their corresponding subscriber UUIDs for outbound call leg using table provisioning.voip\_cc\_mappings table {"uuid", "auth\_key", "source\_uuid"}

Table 19. Calling Cards

Column	Description
uuid	The internal UUID of the pilot subscriber
auth_key	Authentication key (PIN)
source_uuid	The internal UUID of the subscriber that is authorized for outgoing call leg

### 7.24.1. Administrative Configuration

#### Subscriber provisioning

In order to use the calling cards service the user creates a Call Forward to destination *Calling Card* for the designated subscriber that will be used as the access number for this service.

#### Sound Set provisioning

In order for the Calling Card application to work a Sound Set must be created and associated with the Domain or Subscriber.

Sound Sets can be defined in *SettingsSound Sets*. To create a new Sound Set, click *Create Sound Set*. Then click the *Files* button. Administrator can upload the default sounds in one of supported languages or uploaded by the administrator manually in his language of choice.

There is a preference *sound\_set* on Domain and Subscriber levels to link subscribers to the sound set that they should hear (as usual the subscriber preference overrides the domain one).

The screenshot displays the 'Sound Sets' management interface. On the left is a sidebar with navigation icons for various system settings. The main area features a 'Sound Sets' title, a 'Create Sound Set' button, and a table listing existing sound sets. The table has columns for ID, Reseller, Customer, Name, Description, Parent, and Expose to Customer. One entry is shown with ID 6, Reseller 'default', Customer 'default-customer@default.invalid', Name 'ddd', and Description 'ddd'. Below the table, it indicates 'Showing 1 to 1 of 1 entries (filtered from 16 total entries)'. There are also search and pagination controls.

## Manage Sound Set ddd

☰ Sound Sets ★ Load Default Files
⌵ Expand Groups

Name	Filename	Loop
and		<input type="checkbox"/>
busy_ringback_tone		<input type="checkbox"/>
calling_card_not_found		<input type="checkbox"/>
connecting		<input type="checkbox"/>
could_not_connect		<input type="checkbox"/>
credits_successfully_transferred		<input type="checkbox"/>

**NOTE** | You may use 8 or 16 bit mono WAV audio files for all of the voice prompts.

## CLI configuration

The CLI on the outgoing call from the calling card app can be configured in one of the following ways using subscriber preferences:

- 1) Show original caller's CLI: the calling card subscriber can have `allowed_clis: * (any)`. The `sems` application will send the original caller's CLI in the `From` header, which is then validated by the SIP proxy and sent out.
- 2) Show number of the pilot (calling card) subscriber: the calling card subscriber shall have an empty `allowed_clis` and `desired number` set as value of `user_cli` preference. The SIP proxy overrides the original caller's CLI in UPN with the value of the `user_cli` preference. The peer must have set `outbound_from_user`, `outbound_from_display: User-Provided Number`.

### 7.24.2. Call Flow

The call arrives at `sems` application server with `Request-URI` user `callingcard`.

#### Internal Header Parameters

The INVITE contains an extra SIP header `P-App-Param` with the following parameters:

Table 20. SIP Header parameters for calling card application

Name	Meaning
<code>uuid</code>	The internal UUID of the pilot subscriber
<code>outgoing_cli</code>	New CLI to be used by <code>sems</code> application for the outgoing call leg

#### Caller authorization

- `sems` requests the user to enter their PIN and starts the digit collection. The digit collection process is terminated after 5 seconds (configurable in `sems` config file) or by pressing the '#' key. The user can start entering the destination while the voice prompt is being played.
- `sems` checks that the PIN is valid and belongs to the pilot subscriber using the mapping as shown in the table. It fetches UUID of the subscriber to be used for outgoing call leg: `select source_uuid from provisioning.voip_cc_mappings where uuid=$uuid and auth_key=$pin;`

- If the check fails sems will request the user to re-enter their PIN up to the configured maximum number of times.
- If the process is successful, it proceed with the call setup, making the call on behalf of the subscriber determined by the source\_uuid key as follows.

### Outgoing call

Sems application plays back the available balance of the customer. Sems requests the user to enter destination and starts digit collection. Digit collection process is terminated after 5 seconds (configurable in sems config file) or by pressing the '#' key. User can start entering destination while the voice prompt is being played.

Sems sends INVITE to the proxy with Request-URI: sip:\$number@\$outboundproxy;sw\_domain=\$subscriber.domain

From: \$outgoing\_cli

On receiving the 401 or 407 response from the proxy the application authenticates using the digest credentials retrieved for the subscriber for outgoing call leg from the voip\_subscribers table: select s.username, s.password, d.domain from provisioning.voip\_subscribers s, provisioning.voip\_domains d where s.uuid=\$source\_uuid and s.domain\_id=d.id;

### Voucher recharge

During the destination collection phase in the calling card application, the user can enter special code \*1\*<pin># (configurable in sems config file) to transfer balance from another calling card customer to the currently authorized customer. Sems transfers all remaining balance from that customer to the current customer.

### Billing

The call via calling card application as well as call-through generates three CDRs:

- A to B: The incoming call from any source to the call-through subscriber.
- B to callingcard@app.local or callthrough@app.local: The call forward to the sems application.
- B to C: The outgoing call to the final destination. The three CDRs are handled by the billing process as usual, exported and shown in all call lists. .

## 7.25. Invoices and Invoice Templates

Content and vision of the invoices are customizable by [Invoice Templates](#).

**NOTE** | The Sipwise C5 generates invoices in pdf format.

### 7.25.1. Invoices Management

Invoices can be requested for generation, searched, downloaded and deleted on the administrative web interface. Navigate to *Settings Invoices* menu and you get a list of all invoices currently stored in the database.

**TIP**

The system operator or a third party application can also generate, list, retrieve and delete invoices via the REST API. Please read further details in [Invoice Management via REST API](#).

#	Customer #	Customer Email	Serial
2	4	default-customer@default.invalid	INV2020040000002
3	15	bbbb@bbbb.com	INV2020110000003
5	113	default-customer@default.invalid	INV2021110000005
55	97	dimitri@techit.be	INV2021120000055

To request invoice generation for the particular customer/reseller/peer and period, press the "Create Invoice" button. On the invoice creation form, fill in the following parameters:

- **Template:** A prepared invoice template can be selected for the invoice generation.
- **Contract:** The owner of the billing account, recipient of the invoice.
  - Customer Invoice:* Customer Contract
  - Reseller Invoice:* Reseller Contract
  - Peer Invoice:* Peering Group Contract
- **Invoice period:** The billing period. This can only be specified as one calendar month. Calls with start time between the first and last second of the period will be considered for the invoice

All form fields are mandatory.

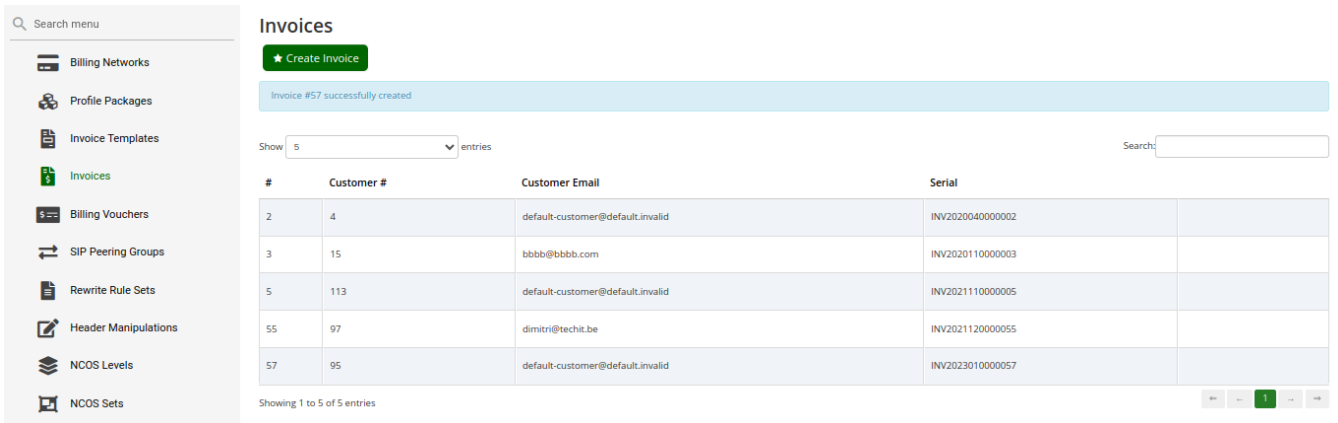
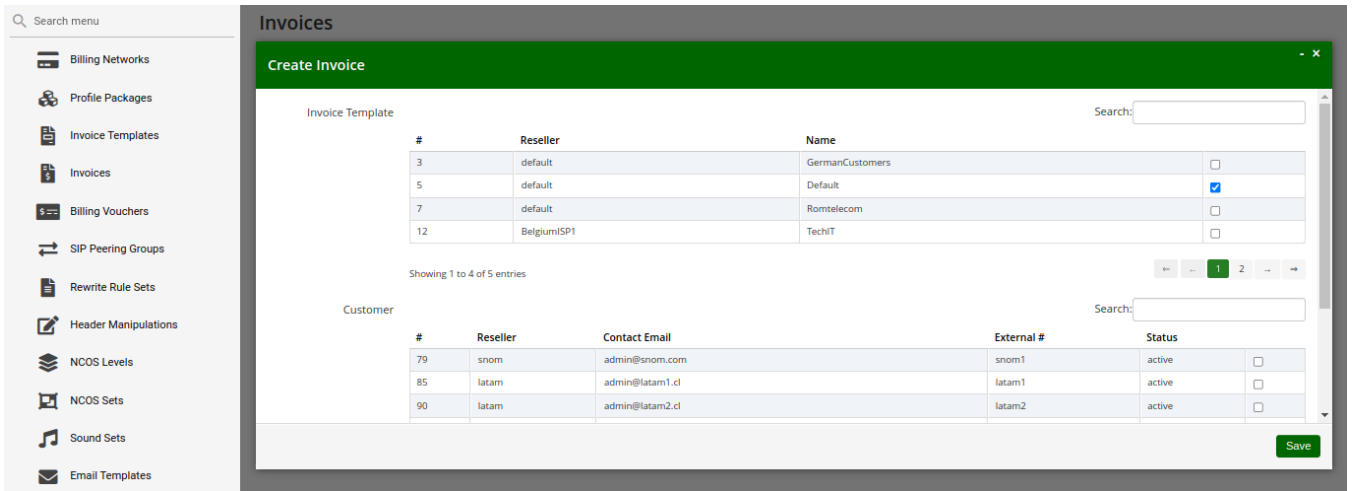

Generated invoice can be downloaded as pdf file.

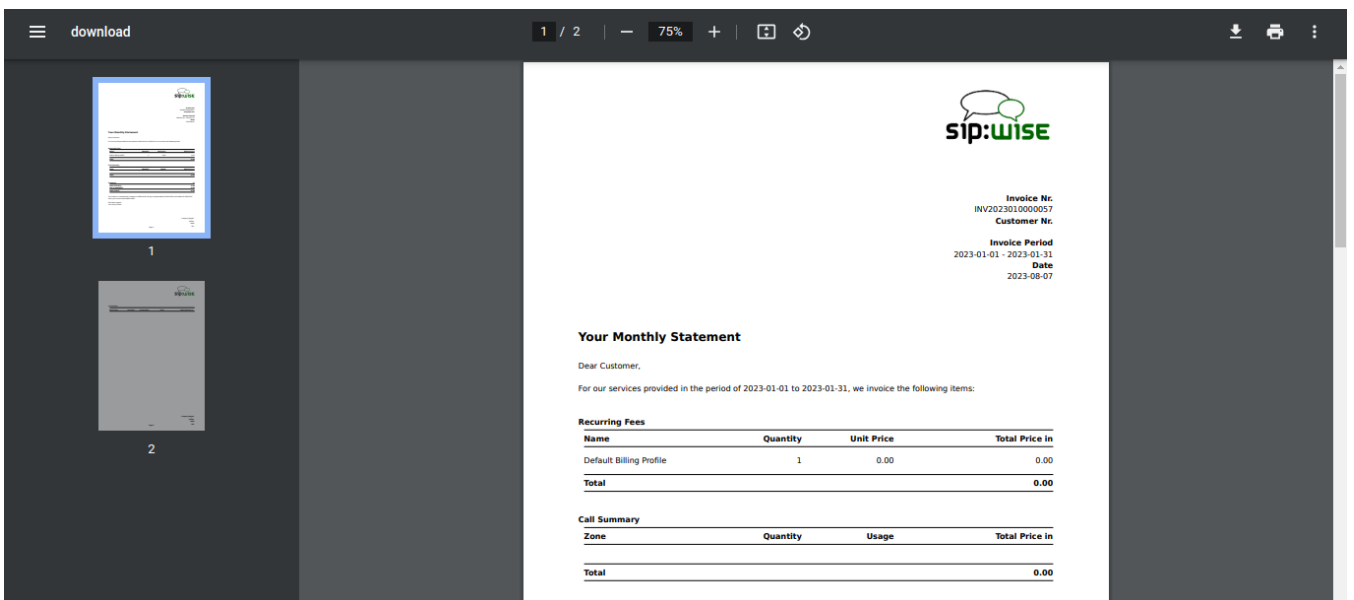

To proceed, press the "Download" button in the Invoices section.

Press the "Delete" button to delete the invoice.

## 7.25.2. Invoice Management via REST API

Besides managing invoices on the admin web interface of NGCP, the system administrator (or a third party system) has the opportunity to request generation and retrieval of invoices via the *REST API*.

The subsequent sections describe the available operations for invoice management with API requests in details. All operations work on the *Invoices* resource and use the `/api/invoices` base path. The authentication method is username/password in the examples given below, however it is recommended to use a TLS client certificate for authentication on the REST API.

### NOTE

The full API documentation is always available at the location: `https://<IP_of_NGCP_web_panel>:1443/api`

### Generate a New Invoice

The following example shows a CURL command that will request generation of an invoice:

- for contract with ID "79"
- for the time period of August 2023
- based on the invoice template with ID "1"

```
curl -i -X POST -H 'Connection: close' -H 'Content-Type:
application/json' \
  --user adminuser:adminpwd -k 'https://127.0.0.1:1443/api/invoices/'
\
  --data-binary '{ "customer_id" : "79", "template_id" : "1",
\
  "period_start": "2023-08-01 00:00:00", "period_end": "2022-08-31
23:59:59" }'
```

Please note that in this operation the `/api/invoices` path (the *invoices* collection) was used and a *POST* request on it to create a new invoice item.

In case of a **successful operation**, the Sipwise C5 will reply with `**201 Created**` HTTP status and send the ID of the invoice in *Location* header. In our example the new invoice item may be directly referred as `/api/invoices/3` (ID = 3).

```
HTTP/1.1 201 Created
Server: nginx
Date: Tue, 12 Sep 2023 13:38:40 GMT
Content-Length: 0
Connection: close
Location: /api/invoices/3
Set-Cookie: ngcp_panel_session=d5e4a8dd003fd7cac646653a6b5aefa703cf3e66;
path=/; expires=Tue, 12-Sep-2023 14:38:38 GMT; HttpOnly
X-Catalyst: 5.90114
Strict-Transport-Security: max-age=15768000
```

In case of a **failed operation**, e.g. when an invoicing period that is invalid for the customer is requested,

the Sipwise C5 will reply with **422 Unprocessable Entity** or **500 Internal Server Error** HTTP status.

### Download Invoice Data

You can download properties / data of a specific invoice by selecting the item by its ID, using an HTTP *GET* request.

```
curl -i -X GET -H 'Connection: close' --user adminuser:adminpwd -k \
'https://127.0.0.1:1443/api/invoices/3'
```

The above request will return a JSON data structure containing invoice properties:

```
HTTP/1.1 200 OK
Server: nginx
Date: Tue, 12 Sep 2023 12:13:04 GMT
Content-Type: application/hal+json;
profile="http://purl.org/sipwise/ngcp-api/"; charset=utf-8
Content-Length: 759
Connection: close
Link: </api/invoices/>; rel=collection
Link: <http://purl.org/sipwise/ngcp-api/>; rel=profile
Link: </api/invoices/3>; rel="item self"
Link: </api/invoices/3>; rel="item http://purl.org/sipwise/ngcp-
api/#rel-invoices"
Link: </api/customers/79>; rel="item http://purl.org/sipwise/ngcp-
api/#rel-customers"
Set-Cookie: ngcp_panel_session=219fecbee4fa936defd1ee511c84efe7b5a6d6a;
path=/; expires=Wed, 12-Sep-2023 13:13:03 GMT; HttpOnly
Strict-Transport-Security: max-age=15768000

{
  "_links" : {
    "collection" : {
      "href" : "/api/invoices/"
    },
    "curies" : {
      "href" : "http://purl.org/sipwise/ngcp-api/#rel-{rel}",
      "name" : "ngcp",
      "templated" : true
    },
    "ngcp:customers" : {
      "href" : "/api/customers/79"
    },
    "ngcp:invoices" : {
      "href" : "/api/invoices/3"
    },
    "profile" : {
      "href" : "http://purl.org/sipwise/ngcp-api/"
    },
    "self" : {
```

```

    "href" : "/api/invoices/3"
  }
},
"amount_net" : 0,
"amount_total" : 0,
"amount_vat" : 0,
"id" : 3,
"period_end" : "2023-08-31T23:59:59+00:00",
"period_start" : "2023-08-01T00:00:00+00:00",
"sent_date" : null,
"serial" : "INV202308000003"
}

```

It is also possible to query the complete *invoices* collection and use a filter (e.g. invoicing period, contract ID, etc.) to get the desired invoice item. In the example below we request all available invoices that belong to the customer with ID "79".

```

curl -i -X GET -H 'Connection: close' --user adminuser:adminpwd -k \
'https://127.0.0.1:1443/api/invoices/?customer_id=79'

```

The returned dataset is now slightly different because it is represented as an array of items, although in our example the array consist of only 1 item:

```

{
  "_embedded" : {
    "ngcp:invoices" : [
      {
        "_links" : {
          "collection" : {
            "href" : "/api/invoices/"
          },
          "curies" : {
            "href" : "http://purl.org/sipwise/ngcp-api/#rel-
{rel}",
            "name" : "ngcp",
            "templated" : true
          },
          "ngcp:customers" : {
            "href" : "/api/customers/79"
          },
          "ngcp:invoices" : {
            "href" : "/api/invoices/3"
          },
          "profile" : {
            "href" : "http://purl.org/sipwise/ngcp-api/"
          },
          "self" : {
            "href" : "/api/invoices/3"
          }
        }
      }
    ]
  }
}

```

```

    },
    "amount_net" : 0,
    "amount_total" : 0,
    "amount_vat" : 0,
    "id" : 3,
    "period_end" : "2023-08-31T23:59:59+00:00",
    "period_start" : "2023-08-01T00:00:00+00:00",
    "sent_date" : null,
    "serial" : "INV20230800000003"
  }
]
},
"_links" : {
  "curies" : {
    "href" : "http://purl.org/sipwise/ngcp-api/#rel-{rel}",
    "name" : "ngcp",
    "templated" : true
  },
  "ngcp:invoices" : {
    "href" : "/api/invoices/3"
  },
  "profile" : {
    "href" : "http://purl.org/sipwise/ngcp-api/"
  },
  "self" : {
    "href" : "/api/invoices/?page=1&rows=10"
  }
},
"total_count" : 1
}

```

### Download Invoice as PDF File

You can download a specific invoice as a PDF file in the following way:

- selecting the item by its ID (as in our example, but you can also use a filter and query the complete *invoices* collection)
- using an HTTP *GET* request
- adding **"Accept: application/pdf" header** to the request

```

curl -X GET -H 'Connection: close' -H 'Accept: application/pdf' \
  --user adminuser:adminpwd -k 'https://127.0.0.1:1443/api/invoices/3' >
  result.pdf

```

**Please note** that in the example above we **do not add the "-i" option** that would also include the headers of the HTTP response in the output file. The output of the CURL command, i.e. the PDF file, is saved as "result.pdf" locally.

## Delete an Invoice

In order to delete an invoice item you have to send a *DELETE* request on the specific item:

```
curl -i -X DELETE -H 'Connection: close' --user adminuser:adminpwd -k \
'https://127.0.0.1:1443/api/invoices/3'
```

In case of successful deletion Sipwise C5 should send HTTP status **204 No Content** as a response:

```
HTTP/1.1 204 No Content
Server: nginx
Date: Tue, 12 Sep 2023 13:42:42 GMT
Connection: close
Set-Cookie: ngcp_panel_session=10b66a6baf25a09739c2bb2377c70ecceee78387;
path=/; expires=Wed, 12-Sep-2023 14:42:42 GMT; HttpOnly
X-Catalyst: 5.90114
Strict-Transport-Security: max-age=15768000
```

### 7.25.3. Invoice Templates

Invoice template defines the structure and look of the generated invoices. The Sipwise C5 allows to create several invoice templates. Multiple invoice templates can be used to create invoices for the different contract types and different languages.

For the deprecated batch invoice generator, each contract was supposed to be associated to one of the existing invoice templates. The encouraged approach is to use the REST API to trigger invoice creation per contract.

#### NOTE

Call cost sums from CDRs are used for invoices, which allows to restrict by call direction and use rated call costs according to the carrier/reseller/customer billing fees.

#### IMPORTANT

Generating invoices require CDRs for the billing period, so ensure the CDR retention period is set accordingly in the cleanup/archiving configuration.

## Invoice Templates Management

Invoice templates can be searched, created, edited and deleted in the invoice templates management interface.

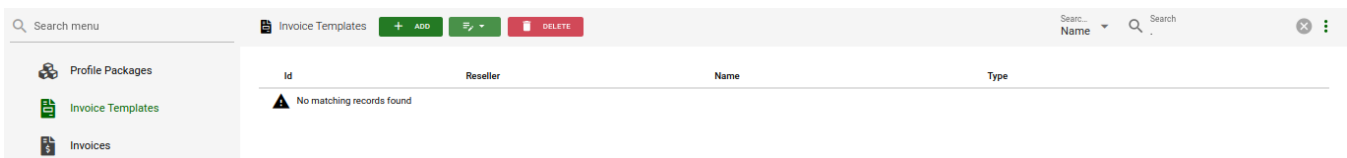

Invoice template creation is separated on two steps:

- Create a new invoice template with meta information.
- Visually edit content (template itself) of the invoice template.

To start a new invoice template, press "Create Invoice Template" button.

On the invoice template meta information form, the following parameters can be specified:

- **Reseller:** The reseller who owns this invoice template. For customer/DID invoices, this is mandatory so each reseller have their individual set of templates for their end customers. Templates for peer and reseller invoices are maintained by the platform operator, so the reseller has to be empty for those categories.
- **Name:** A unique invoice template name to differentiate invoice templates if there are some.
- **Type:** Currently the Sipwise C5 supports only SVG format of the invoice templates.
- **Call Direction:** Information of the calls that are going to included in the invoice. Whether it is outgoing only, incoming only or both.
- **Category:** This defines the invoice type:

*Customer:* The intrinsic invoice type that resellers use to charge end customers. Invoices using a template of the *Customer* category will require a customer contract. They present call costs rated according to the billing fees of the source/destination customer contract.

*Reseller:* The invoice type that the platform operator uses to charge resellers. Invoices using a template of the *Reseller* category will require a reseller contract. They present call costs rated according to the billing fees of the source/destination reseller contract.

*Peer:* The invoice the platform operator uses to charge peering partners or verify their costs. Invoices using a template of the *Peer* category will require a peering group contract. They present call costs rated according to the billing fees of the source/destination peering group contract.

*DID:* A special invoice type that resellers use to charge end customers with detailed cost breakdown per subscriber - DID (Direct Inward Dialing) extensions respectively. Invoices using a template of the *Customer* category will require a customer contract. They present call costs rated according to the billing fees of the source/destination customer contract.

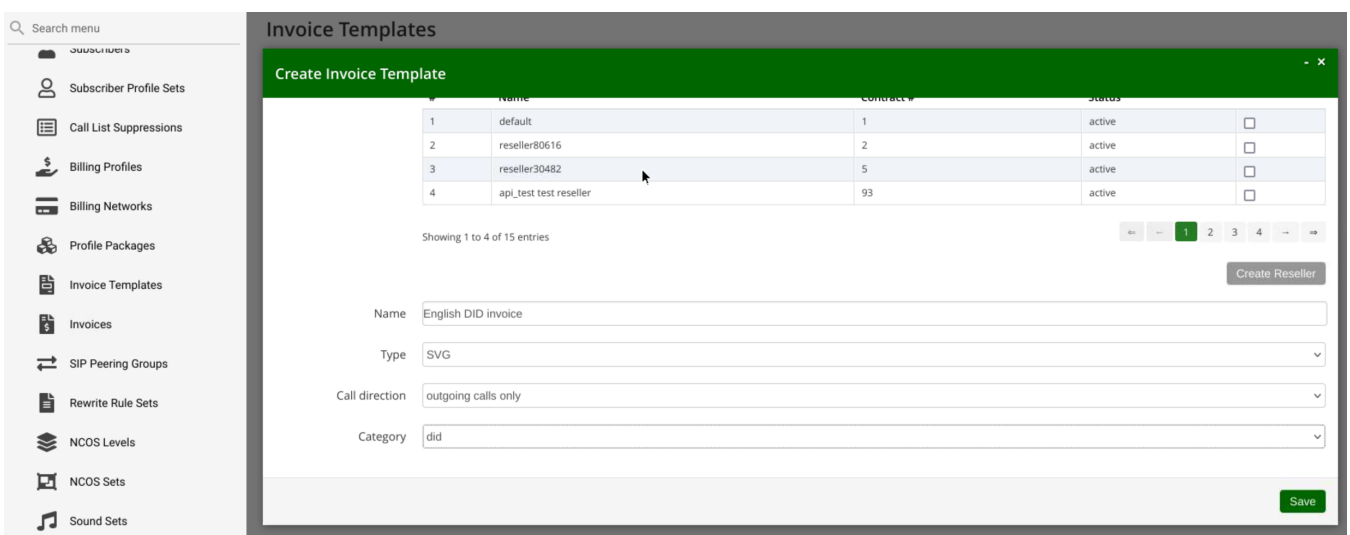

The screenshot shows the 'Create Invoice Template' form in the Sipwise NGCP interface. The form is titled 'Create Invoice Template' and is part of the 'Invoice Templates' section. It shows a table of existing templates and a form to create a new one.

ID	Name	Contract #	Status	Actions
1	default	1	active	<input type="checkbox"/>
2	reseller80616	2	active	<input type="checkbox"/>
3	reseller30482	5	active	<input type="checkbox"/>
4	api_test test reseller	93	active	<input type="checkbox"/>

Showing 1 to 4 of 15 entries

Form fields:

- Name: English DID invoice
- Type: SVG
- Call direction: outgoing calls only
- Category: did

Buttons: Create Reseller, Save

After registering the new invoice template you can change the invoice template structure in WYSIWYG SVG editor and preview the result of the invoice generation based on the template.

## Invoice Template Content

The invoice template is a XML SVG source, which describes the content, look and position of the text lines, images or other invoice template elements. The Sipwise C5 provides embedded WYSIWYG SVG editor `svg-edit 2.6` to customize default template. The Sipwise C5 `svg-edit` has some changes in layers management, image edit, user interface, but this [basic introduction](#) may still be useful.

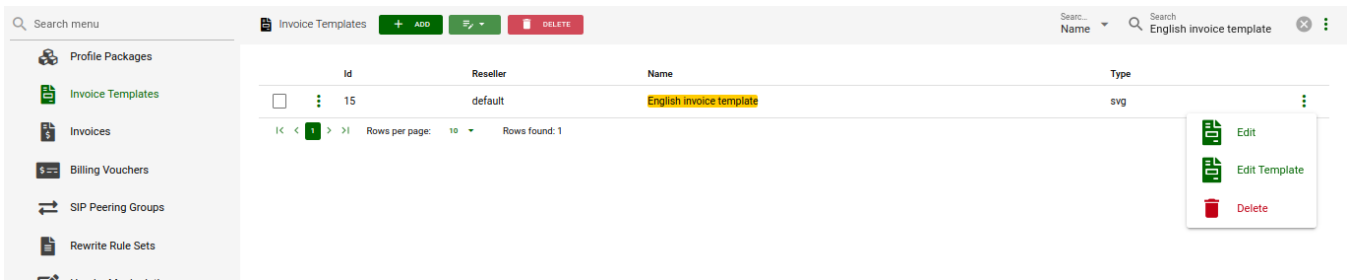

Template refers to the owner reseller contact ("rescontact"), contract ("customer" or "contract"), customer contact ("custcontact"), billing profile ("billprof"), invoice ("invoice") data as variables in the "[%%]" mark-up with detailed information accessed as field name after point e.g. [%invoice.serial%]. During invoice generation all variables or other special tokens in the "[% %]" mark-ups will be replaced by their database values.

Press the "Show variables" button on the top of the screen to see full list of variables with the fields:

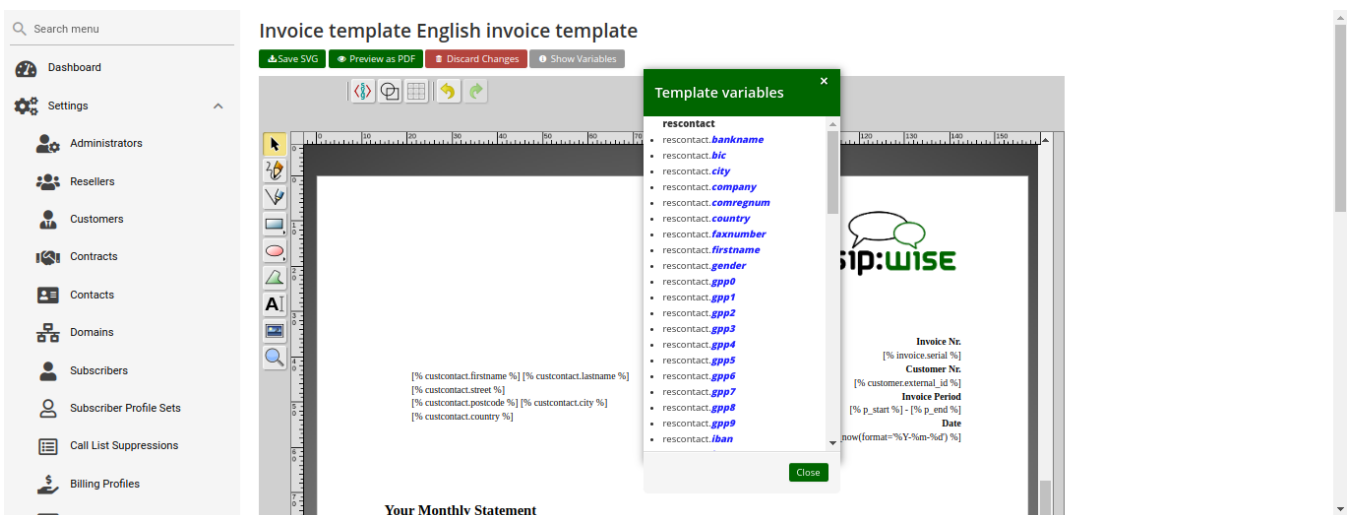

You can add/change/remove embedded variables references directly in main `svg-edit` window. To edit text line in `svg-edit` main window double click on the text and place cursor on desired position in the text.

After implementing the desired template changes, [save the invoice template changes](#).

To return to the Sipwise C5 invoice template **default** content you can press on the "Discard changes" button.

### IMPORTANT

The "Discard changes" operation can't be undone.

## Layers

Default template contains three groups elements (`<g/>`), which can be thought of as pages, or in terms of `svg-edit` - layers. Layers are:

- **Background:** special layer, which will be repeated as background for every other page of the invoice.
- **Summary:** page with a invoice summary.
- **CallList:** page with calls made in a invoice period. Available only to customer invoices with *outgoing* call direction and *incoming* call direction.
- **DID ZoneCalls:** page with zone costs like in the summary, but broken down for each the customer contract's subscribers. Available to DID invoices only.

To see all invoice template layers, press on "Layers" vertical sign on right side of the svg-edit interface:

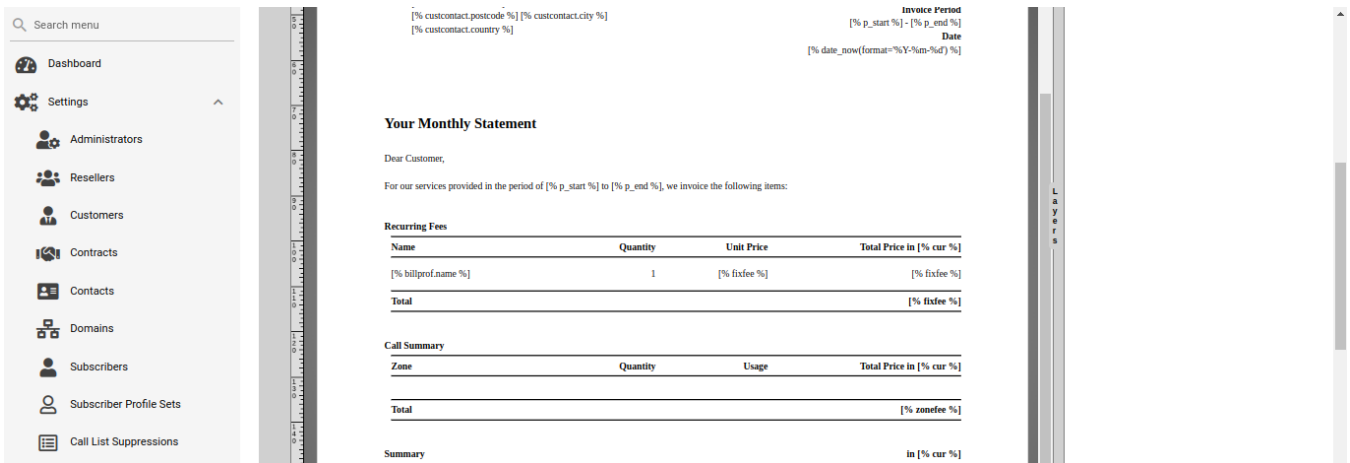

Side panel with layers list will be shown.

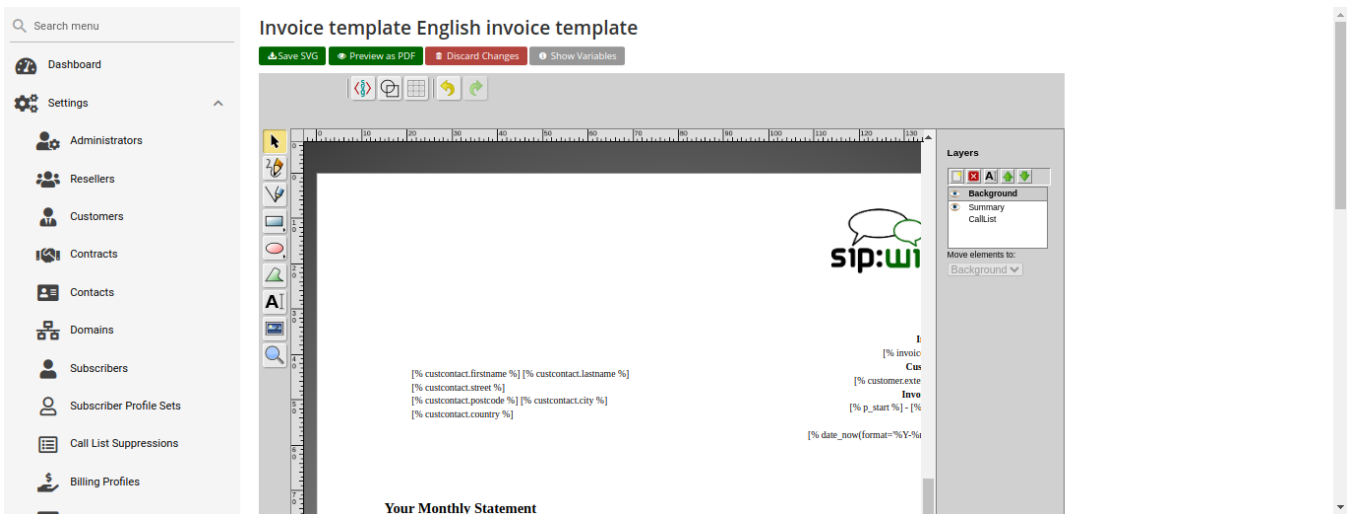

One of the layers is active, and its element can be edited in the main svg-edit window. Currently active layer's name is **bold** in the layers list. The layers may be visible or invisible. Visible layers have "eye" icon left of their names in the layers list.

To make a layer active, click on its name in the layers list. If the layer was invisible, its elements became visible on activation. Thus you can see mixed elements of some layers, then you can switch off visibility of other layers by click on their "eye" icons. It is good idea to keep the visibility of the "Background" layer on, so look of the generated page will be seen.

### Edit SVG XML source

Sometimes it may be convenient to edit svg source directly and svg-edit makes it possible to do it. After press on the <svg> icon in the top left corner of the svg-edit interface:

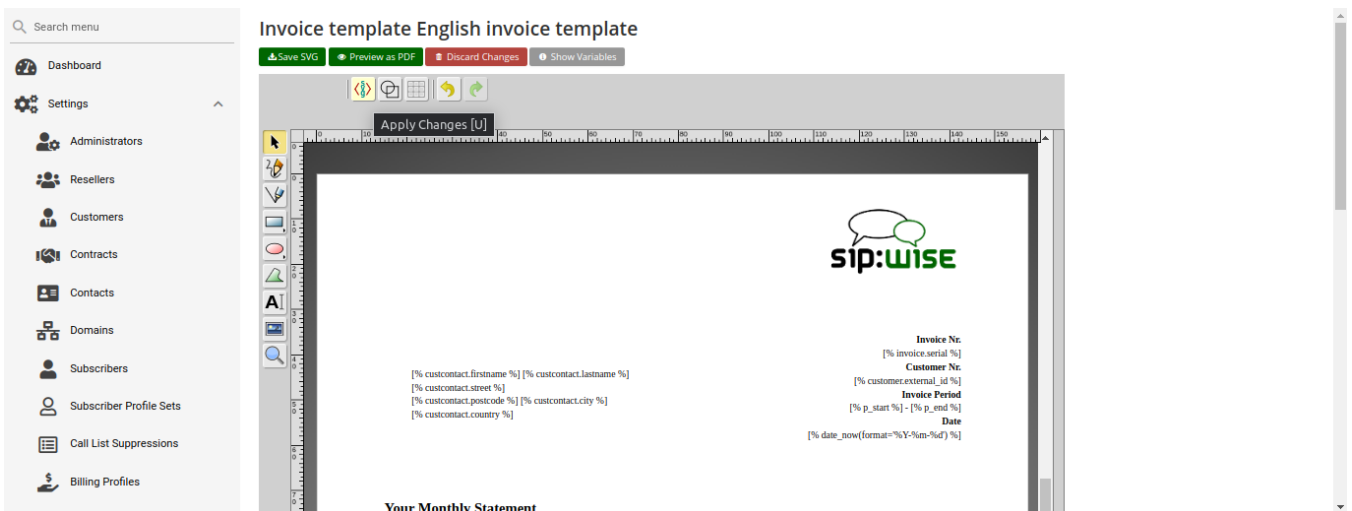

SVG XML source of the invoice template will be shown.

SVG source can be edited in place or copy-pasted as usual text.

**NOTE** | Template keeps sizes and distances in pixels.

### IMPORTANT

When editing svg xml source, please change things inside special comment mark-up "<!--{ }-" very carefully. Failure to do so may result in potential disruptions to the invoice generation process. Please be sure that document structure repeats default invoice template: has the same groups (<g/>) elements on the top level, text inside special comments mark-up "<!--{ }-" preserved or changed appropriately, svg xml structure is correct.

To save your changes in the svg xml source, first press "OK" button on the top left corner of the source page:

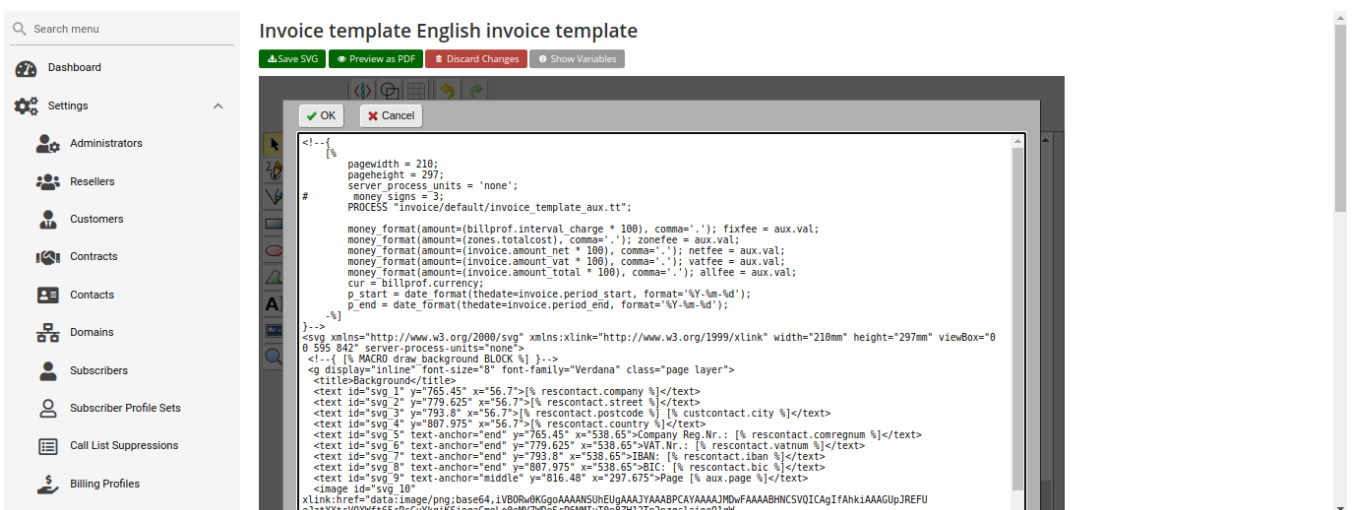

And then [save invoice template changes](#).

### NOTE

You can copy and keep the SVG source of your template as a file on the disk before start experimenting with the template. Later you will be able to return to this version

replacing svg source.

### Change logo image

- Make sure that "Select tool" is active.
- Select default logo, clicking on the logo image.
- Press "Change image" button, which should appear on the top toolbar.

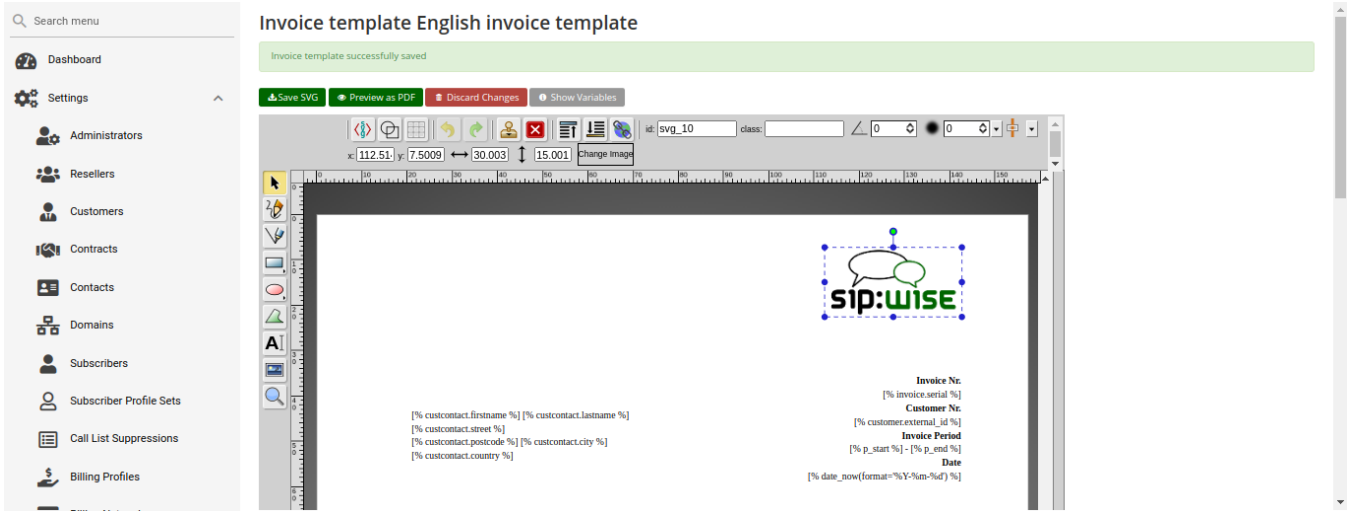

After image uploaded [save invoice template changes](#).

### Save and preview invoice template content

To save invoice template content changes press button "Save SVG".

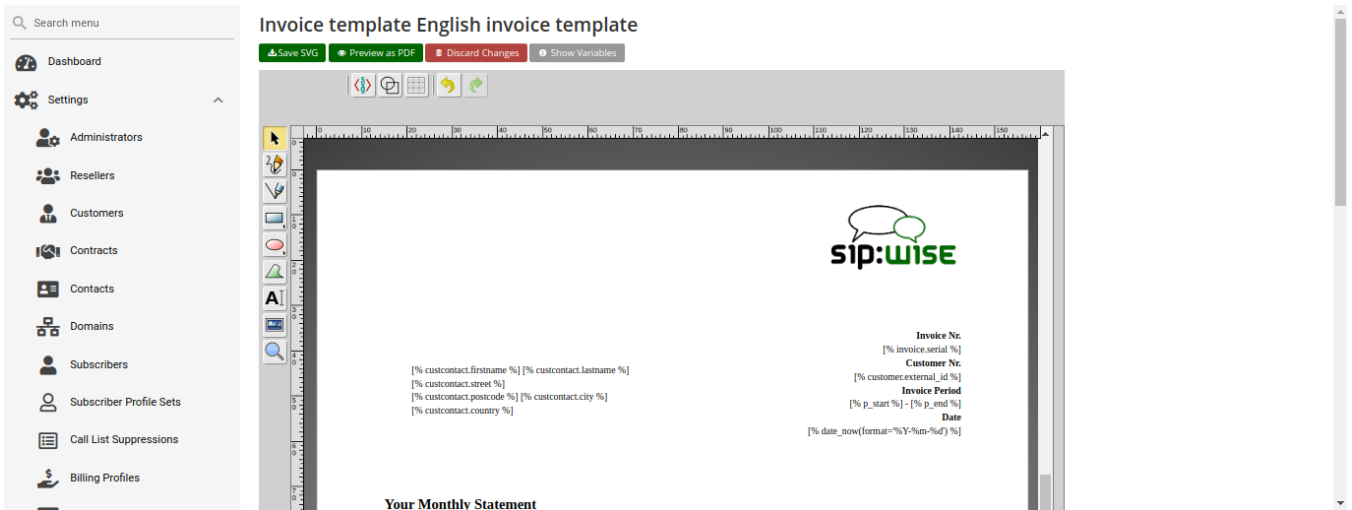

You will see message about successfully saved template. You can preview your invoice look in PDF format. Press on "Preview as PDF" button.

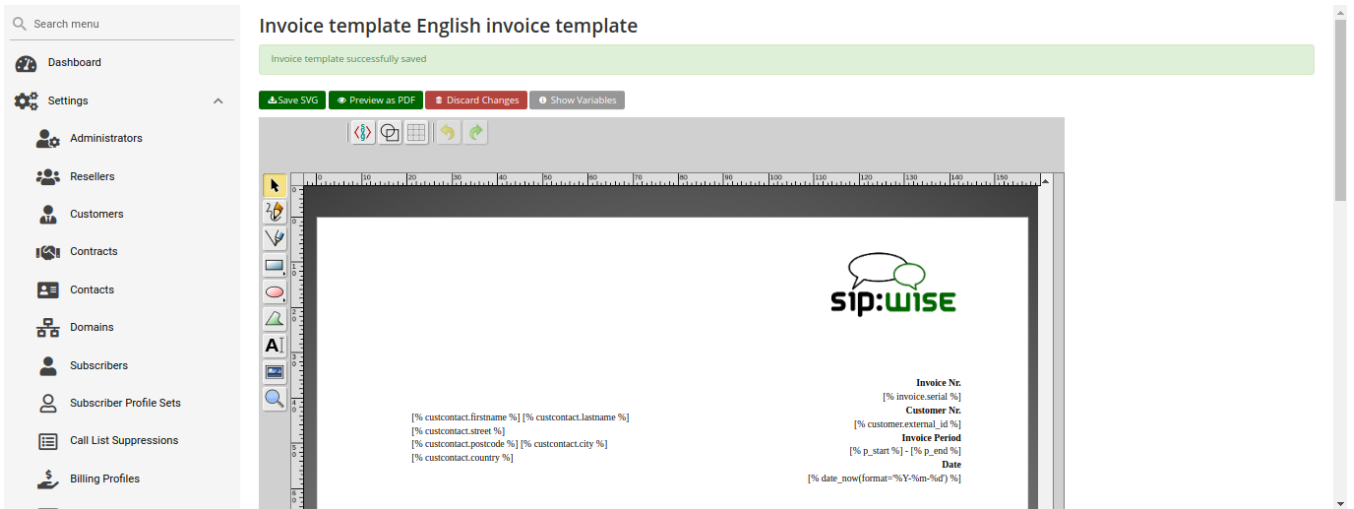

Invoice preview will be opened in the new window.

**NOTE** | Example fake data will be used for preview generation.

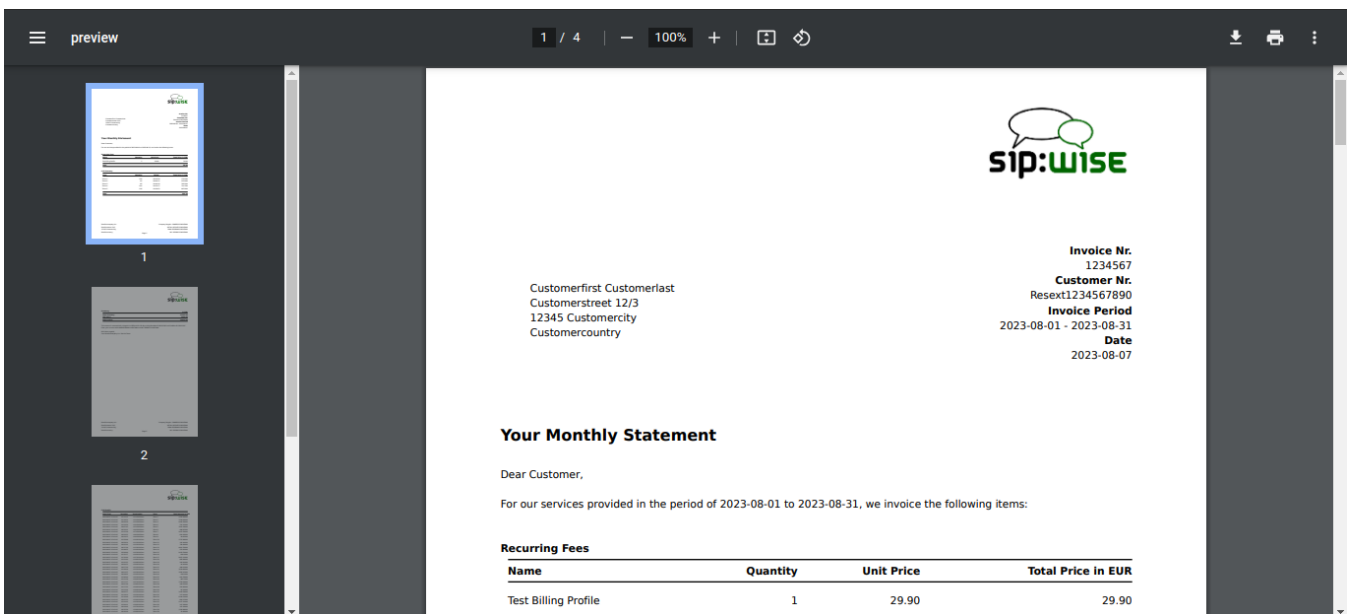

## 7.26. Email Reports and Notifications

### 7.26.1. Email events

The Sipwise C5 makes it possible to customize the content of the emails sent on the following actions:

- Web password reset requested. An email will be sent to the subscriber, for whom the password reset was initiated. If the subscriber does not have an email, an email will be sent to the customer, who owns the subscriber.
- Administrator password reset requested. An email will be sent to the administrator, for whom the password reset was initiated. If the administrator does not have an email, an error message will appear when requesting the password reset.
- New subscriber created. Email will be sent to the newly created subscriber or to the customer, who owns the new subscriber.
- Email with the invoice. The email will be sent to the customer.

### 7.26.2. Initial template values and template variables

Default email templates for each of the email events are inserted on the initial Sipwise C5 database creation. Content of the default template is described in the corresponding sections. Default email templates are not linked to any reseller and cannot be changed through the Sipwise C5 Panel. They will be used to initialize default templates for the newly created reseller.

Each email template refers to the values from the database using special mark-ups "[%" and "%]". Each email template has a fixed set of the variables. Variables cannot be added or changed without changes in the Sipwise C5 Panel code.

### 7.26.3. Subscriber password reset email template

An email will be sent after the subscriber or the subscriber administrator requests a password reset for the subscriber account. If subscriber doesn't have an email, an email will be sent to the customer owning the subscriber.

The default content of the password reset email template is:

<b>Template name</b>	<b>passreset_default_email</b>
<b>From</b>	<a href="mailto:default@sipwise.com">default@sipwise.com</a>
<b>Subject</b>	Password reset email
<b>Body</b>	<p>Dear Customer,</p> <p>Please go to [%url%] to set your password and log into your self-care interface.</p> <p>Your faithful Sipwise system</p> <p>--</p> <p>This is an automatically generated message. Do not reply.</p>

The following variables will be provided to the email template:

- [%url%]: specially generated url where subscriber can define his new password.
- [%subscriber%]: username@domain of the subscriber, which password was requested for reset.

#### 7.26.4. Administrator password reset email template

An email is sent when the administrator requests a password reset for their account. If the administrator does not have an email address, an error message will be displayed when requesting the password reset.

The default content of the password reset email template is:

<b>Template name</b>	<b>admin_passreset_default_email</b>
<b>From</b>	<a href="mailto:default@sipwise.com">default@sipwise.com</a>
<b>Subject</b>	Password reset email
<b>Body</b>	Dear Customer,  Please go to [%url%] to set your password and log into your admin interface.  Your faithful Sipwise system  -- This is an automatically generated message. Do not reply.

The following variables will be provided to the email template:

- [%url%]: specially generated url where administrator can define his new password.
- [%admin%]: username@domain of the administrator, which password was requested for reset.

#### 7.26.5. New subscriber notification email template

An email is sent when a new subscriber is created. An email will be sent to the newly created subscriber if they have an email. Otherwise the email will be sent to the customer who owns the subscriber.

##### NOTE

By default, the email content template is addressed to the customer. Please consider this when creating the subscriber with an email.

<b>Template name</b>	<b>subscriber_default_email</b>
<b>From</b>	<a href="mailto:default@sipwise.com">default@sipwise.com</a>
<b>Subject</b>	Subscriber created

<b>Body</b>	<p>Dear Customer,</p> <p>A new subscriber [%subscriber%] has been created for you.</p> <p>Your faithful Sipwise system</p> <p>--</p> <p>This is an automatically generated message. Do not reply.</p>
-------------	---

The following variables will be provided to the email template:

- [%url%]: specially generated url where subscriber can define his new password.
- [%subscriber%]: username@domain of the subscriber, which password was requested for reset.

### 7.26.6. Invoice email template

<b>Template name</b>	<b>invoice_default_email</b>
<b>From</b>	<a href="mailto:default@sipwise.com">default@sipwise.com</a>
<b>Subject</b>	Invoice #[%invoice.serial%] from [%invoice.period_start_obj.ymd%] to [%invoice.period_end_obj.ymd%]
<b>Body</b>	<p>Dear Customer,</p> <p>Please find your invoice #[%invoice.serial%] for [%invoice.period_start_obj.month_name%], [%invoice.period_start_obj.year%] in attachment of this letter.</p> <p>Your faithful Sipwise system</p> <p>--</p> <p>This is an automatically generated message. Do not reply.</p>

The variables passed to the email template:

- [%invoice%]: container variable for the invoice information.

#### *Invoice fields*

- [%invoice.**serial%**]
- [%invoice.**amount\_net%**]
- [%invoice.**amount\_vat%**]
- [%invoice.**amount\_total%**]
- [%invoice.**period\_start\_obj%**]
- [%invoice.**period\_end\_obj%**]

#### **NOTE**

The fields [%invoice.period\_start\_obj%] and [%invoice.period\_end\_obj%] provide methods of the perl package DateTime for the invoice start date and end date. Further information about DateTime can be obtained from the package documentation:

man DateTime

- [%**provider**%]: container variable for the reseller contact. All database contact values will be available.
- [%**client**%]: container variable for the customer contact.

*Contact fields example for the "provider". Replace "provider" to client to access proper "customer" contact fields.*

- [%provider.**gender**%]
- [%provider.**firstname**%]
- [%provider.**lastname**%]
- [%provider.**comregnum**%]
- [%provider.**company**%]
- [%provider.**street**%]
- [%provider.**postcode**%]
- [%provider.**city**%]
- [%provider.**country**%]
- [%provider.**phonenumber**%]
- [%provider.**mobilenumber**%]
- [%provider.**email**%]
- [%provider.**newsletter**%]
- [%provider.**faxnumber**%]
- [%provider.**iban**%]
- [%provider.**bic**%]
- [%provider.**vatnum**%]
- [%provider.**bankname**%]
- [%provider.**gppo** - provider.**gpp9**%]

## NOTE

## 7.26.7. Email templates management

Email templates linked to the resellers can be customized in the email templates management interface. For the administrative account, the email templates from all resellers will be displayed, while for the reseller account, only their own email templates will be visible.

The screenshot displays the 'Email Templates' management interface. On the left is a sidebar with a search menu and navigation icons for NCOS Levels, NCOS Sets, Sound Sets, Email Templates (which is highlighted), Device Management, and Security Bans. The main area has a title 'Email Templates' and two green buttons: 'Create Email Template' and 'Sync Email Templates'. Below these are a dropdown menu for 'Show all templates', a 'Show' dropdown set to '5 entries', and a search input field. A table with columns '#', 'Reseller', 'Name', 'From', and 'Subject' is shown, with the message 'No matching records found'. At the bottom, it indicates 'Showing 0 to 0 of 0 entries (filtered from 136 total entries)'.

To create new email template press button "Create Email Template".

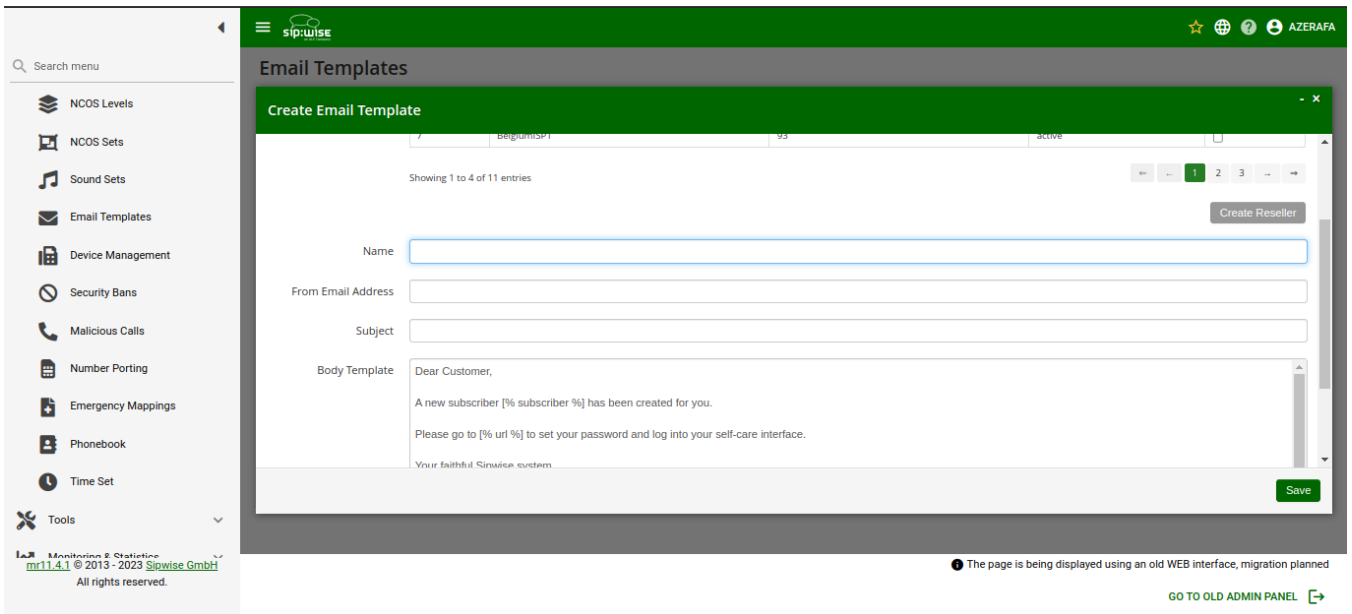

On the email template form all fields are mandatory:

- **Reseller:** The reseller who owns this email template.
- **Name:** Currently only an email template with the following names will be considered by the Sipwise C5 on the [Email event](#) :
  - admin\_passreset\_default\_email;
  - passreset\_default\_email;
  - subscriber\_default\_email;
  - invoice\_default\_email;
- **From Email Address:** An email address which will be used in the From field in the email sent by the Sipwise C5 .
- **Subject:** Template of the email subject. Subject will be processed with the same template variables as the email body.
- **Body:** Email text template. Will be processed with appropriate template variables.

## 7.27. Calling Line Identification Restriction

The Calling Line Identification Restriction (CLIR) feature prevents the calling party's number from being displayed to the called party. It is the opposite of Calling Line Identification Presentation (CLIP).

### 7.27.1. How it works

When CLIR is activated the Sipwise C5 platform does the following:

1. The From header is set to 'From: "Anonymous" <sip:anonymous@anonymous.invalid>".
2. The "Privacy: id" SIP header is added to tell the downstream SIP entities to hide the identity.
3. Optionally, only if the 'pai\_clir' preference is set. The P-Asserted Identity PAI header is replaced with 'anonymous@anonymous.invalid'.

### 7.27.2. How to activate it

It can be activated using the dedicated 'clir' caller's preference in the administrative interface or in the CSC panel. Alternatively it can be enabled permanently or per single call by the subscriber using the [Vertical Service Code \(VSC\) Interface](#).

By default, the 'clir' feature is not activated for calls done between subscribers belonging to the same PBX customers. In case it is required to anonymize also internal PBX calls, then the 'clir\_intrapbx' has to be enabled as well.

The 'clir\_override' callee's preference can be used to force the display of the caller number even if the CLIR feature was originally activated.

## 7.28. Connected Line Identification Restriction

The Connected Line Identification Restriction (COLR) feature prevents the calling party's name and number from being displayed to the caller party. It is the opposite of Connected Line Identification Presentation (COLP).

### 7.28.1. How it works

When COLR is activated the Sipwise C5 platform does the following:

1. The P-Asserted Identity PAI header in the upstream messages (e.g. the 180 Ringing and then 200 OK messages) is replaced with 'anonymous@anonymous.invalid'.

### 7.28.2. How to activate it

It can be activated using the dedicated 'colr' callee's preference in the administrative interface or in the CSC panel. Alternatively it can be enabled permanently or per single call by the subscriber using the [Vertical Service Code \(VSC\) Interface](#).

## 7.29. Do not Disturb

The Do Not Disturb (DND) feature allows users to block incoming call temporarily. When activated, calls are diverted to a predefined message informing the caller that the user is not accepting calls. The DND helps avoid interruptions during meetings, rest periods, or focused work.

The DND feature can be activated in 3 different ways:

- by the administrators from the administrative web interface.
- by the subscriber itself using the [Vertical Service Code \(VSC\) Interface](#).
- by the subscriber itself using the CSC panel, if activated.

The default return code and reason in case of DND can be customized using the config.yml parameters: `'kamailio.proxy.early_rejects.dnd.announce_code'` and `'kamailio.proxy.early_rejects.dnd.announce_reason'`. The announcement can be customized as well using the sound\_set handle `'callee_dnd'` under the `'early_rejects'` group.

## 7.30. The Vertical Service Code Interface

*Vertical Service Codes* (VSC) are codes a user can dial on his phone to provision specific features for his subscriber account. The format is `*<code>*<value>` to activate a specific feature, and `#<code>` or `#<code>#` to deactivate it. The *code* parameter is a two-digit code, e.g. 72. The *value* parameter is the value being set for the corresponding feature.

### IMPORTANT

The *value* user input is normalized using the Rewrite Rules Sets assigned to domain as described in [Configuring Rewrite Rule Sets](#).

By default, the following codes are configured for setting features. The examples below assume that there is a domain rewrite rule normalizing the number format `0<ac><sn>` to `<cc><ac><sn>` using 43 as country code.

### 7.30.1. Call Forward setup using Vertical Service Codes

- **72** - Call Forward Unconditional

`*72*<dest_number>` creates the Call Forward Unconditional, e.g. to 431000 by dialing `*72*01000`.

`#72` deletes the Call Forward Unconditional.

`*72#` enables the Call Forward Unconditional.

`#72#` disables the Call Forward Unconditional.

`**72#` enables/disables the Call Forward Unconditional depending on the previous state.

`*72` retrieve the status of the Call Forward Unconditional with the destination number.

- **90** - Call Forward on Busy

`*90*<dest_number>` creates the Call Forward on Busy, e.g. to 431000 by dialing `*90*01000`.

`#90` deletes the Call Forward on Busy.

`*90#` enables the Call Forward on Busy.

`#90#` disables the Call Forward on Busy.

`**90#` enables/disables the Call Forward on Busy depending on the previous state.

`*90` retrieve the status of the Call Forward on Busy with the destination number.

- **92** - Call Forward on Timeout

`*92*<timeout>*<dest_number>*` creates the Call Forward on Timeout, e.g. after 30 seconds of ringing to 431000 by dialing `*92*30*01000`.

`#92` deletes the Call Forward on Timeout.

`*92#` enables the Call Forward on Timeout.

`#92#` disables the Call Forward on Timeout.

`**92#` enables/disables the Call Forward on Timeout depending on the previous state.

`*92` retrieve the status of the Call Forward on Timeout with the destination number.

- **93** - Call Forward on Not Available

`*93*<dest_number>` creates the Call Forward on Not Available, e.g. to 431000 by dialing `*93*01000`.

- #93 deletes the Call Forward on Not Available.
- \*93# enables the Call Forward on Not Available.
- #93# disables the Call Forward on Not Available.
- \*\*93# enables/disables the Call Forward on Not Available depending on the previous state.
- \*93 retrieve the status of the Call Forward on Not Available with the destination number.

- **96** - All Call Forwards

- #96 deletes at once all the Call Forwards previously configured using VSC.
- #96# disable at once all the Call Forwards previously configured using VSC.

### 7.30.2. Manage Recent Calls using Vertical Service Codes

- **95** - Redial the Last Dialed Number

\*95\* allows to redial the last dialed number by the subscriber. Note: the feature has to be enabled for the subscriber/domain using preference *last\_number\_redial*.

- **71** - Play the Last Caller's Number

\*71\* allows to hear a voice announcement of the last caller's number, after the announcement dial the key defined in *semsvscallback\_last\_caller\_confirmation\_key* to return the call. Note: it is not possible return a call if the caller's number is unavailable.

- **74** - Redial the Last Caller's Number

\*74\* allows to return the call to the last caller's number who called you without hearing the last call ID announcement. Note: it is not possible return a call if the caller's number is unavailable.

- **20** - Delete Recent Calls records

\*20\* allows to remove the records of the recent calls to and from you.

#### IMPORTANT

In order to use the feature codes related to recent calls, the *kamailioproxy\_store\_recentcalls* preference in */etc/ngcp-config/config.yml* has to be set to **yes**. Additionally, to handle caller numbers coming from Peers (e.g. PSTN), set the *kamailioproxyforeign\_domain\_via\_peer* preference to **yes** in */etc/ngcp-config/config.yml* file.

### 7.30.3. General Vertical Service Codes

- **50** - Speed Dial Slot

\*50\*<slot\_number><dest\_number> sets a new Speed Dial Slot, e.g. set slot 1 to 431000 by dialing \*50\*101000, which then can be used by dialing \*1.

- **55** - One-Shot Reminder Call

\*55\*<time> sets One-Shot Reminder Call, e.g. to 08:30 by dialing \*55\*0830.

- **31** - Calling Line Identification Restriction

\*31\*<num\_to\_call> calls the provided number enabling/disabling Calling Line Identification Restriction for that single call, e.g. to call 431000 anonymously make sure to have subscriber's caller preferences 'clir' disabled and dial \*31\*01000. If 'clir' preference is enabled, this will disable Calling Line Identification Restriction for this particular call.

\*31\* enables Calling Line Identification Restriction permanently.

- #31#** disables Calling Line Identification Restriction permanently.
  - \*\*31#** enables/disables Calling Line Identification Restriction permanently depending on the previous state.
- **32** - Block Incoming Anonymous Calls
  - \*32\*** enables Block Incoming Anonymous Calls.
  - #32#** disables Block Incoming Anonymous Calls.
- **77** - Connected Line Identification Restriction
  - \*77\*** enables Connected Line Identification Restriction permanently.
  - #77#** disables Connected Line Identification Restriction permanently.
  - \*\*77#** enables/disables Connected Line Identification Restriction permanently depending on the previous state.
- **78** - Do not Disturb (DND)
  - \*78\*** enables Do not Disturb (DND).
  - #78#** disables Do not Disturb (DND).
  - \*\*78#** enables/disables Do not Disturb (DND) depending on the previous state.
- **80** - Call Block Override PIN
  - \*80\*<pin><num\_to\_call>** calls the provided number using Call Block Override PIN. The PIN has to be the one configured in admin panel to disable the outgoing user/admin block list and NCOS level for a call. For example, when override PIN is set to 7890, dial **\*80\*789001000** to call 431000 bypassing block lists.
- **88** - Deactivate features at once
  - #88** deactivate preference and/or deletes all the Call Forwards at once. By default following features will be disabled: "cfu,cfb,cft,cfna,cfs,cfo,cfr,clir,colr,dnd". It can be customized in the sems configuration files with the parameter 'vsc\_off\_pref\_list'. ATTENTION: at the moment the module supports only CFs and boolean preferences.

#### 7.30.4. Vertical Service Codes for PBX customers

Subscribers under the same PBX customer can enjoy some PBX-specific features by means of special VSCs.

The Sipwise C5 provides the following PBX-specific VSCs:

- **97** - Call Parking
  - \*97\*<parking\_slot>** parks the current call on the selected "parking slot". For example, to park the call to slot no.3, the user should dial the number **\*97\*3**.

*PLEASE NOTE:*

Cisco IP phones provide a softkey for Call Parking, that means the subscriber must only dial the parking slot number after pressing "Park" softkey on the phone.

Other IP phones can perform Call Parking as a *blind transfer*, where the destination of the transfer must be dialled in the format described above.

Both the caller and the callee can park the call.

Parking slots are shared between subscribers that belong to the same domain.

- **98** - Call Unparking

**\*98\*`<parking_slot>`** picks-up a call that was previously parked in the selected "parking slot". For example, to pick-up a call that was parked on slot no.3, a subscriber has to dial **\*98\*3**.

- **99** - Directed Call Pick-up

**\*99\*`<extension_to_pickup>`** allows to pick-up the call directed to another subscriber that is currently ringing. For example, to pick-up the call currently ringing on a subscriber with the extension 23, a subscriber has to dial **\*99\*23**.

### 7.30.5. Configuration of Vertical Service Codes

You can change any of the codes (but not the format) in `/etc/ngcp-config/config.yml` in the section `semsvsc`. After the changes, execute `ngcpcfg apply "changed VSC codes"`.

**CAUTION**

If you have the EMTAs under your control, make sure that the specified VSCs don't overlap with EMTA-internal VSCs, because the VSC calls must be sent to the Sipwise C5 via SIP like normal telephone calls.

### 7.30.6. Voice Prompts for Vertical Service Code Configuration

Table 21. VSC Voice Prompts

Prompt Handle	Related VSC	Message
vsc_error	any	An error has occurred. Please try again later.
vsc_invalid	wrong code	Invalid feature code.
reject_vsc	any	Vertical service codes are disabled for this line.
vsc_cfu_on	72 (Call Forward Unconditional)	Your unconditional call forward has successfully been activated.
vsc_cfu_off	72 (Call Forward Unconditional)	Your unconditional call forward has successfully been deactivated.
vsc_cfb_on	90 (Call Forward Busy)	Your call forward on busy has successfully been activated.
vsc_cfb_off	90 (Call Forward Busy)	Your call forward on busy has successfully been deactivated.
vsc_cft_on	92 (Call Forward on Timeout)	Your call forward on ring timeout has successfully been activated.
vsc_cft_off	92 (Call Forward on Timeout)	Your call forward on ring timeout has successfully been deactivated.
vsc_cfna_on	93 (Call Forward on Not Available)	Your call forward while not reachable has successfully been activated.

Prompt Handle	Related VSC	Message
vsc_cfna_off	93 (Call Forward on Not Available)	Your call forward while not reachable has successfully been deactivated.
vsc_speeddial	50 (Speed Dial Slot)	Your speed dial slot has successfully been stored.
vsc_reminder_on	55 (One-Shot Reminder Call)	Your reminder has successfully been activated.
vsc_reminder_off	55 (One-Shot Reminder Call)	Your reminder has successfully been deactivated.
vsc_blockinclr_on	32 (Block Incoming Anonymous Calls)	Your rejection of anonymous calls has successfully been activated.
vsc_blockinclr_off	32 (Block Incoming Anonymous Calls)	Your rejection of anonymous calls has successfully been deactivated.
vsc_clir_on	31 (Calling Line Identification Restriction)	Your calling line identification restriction service has successfully been activated.
vsc_clir_off	31 (Calling Line Identification Restriction)	Your calling line identification restriction service has successfully been deactivated.
vsc_colr_on	77 (Connected Line Identification Restriction)	Your connected line identification restriction service has successfully been activated.
vsc_colr_off	77 (Connected Line Identification Restriction)	Your connected line identification restriction service has successfully been deactivated.
vsc_dnd_on	78 (Do not Disturb)	Your do not disturb service has successfully been activated.
vsc_dnd_off	78 (Do not Disturb)	Your do not disturb service has successfully been deactivated.
vsc_service_off	88 (Deactivate features at once)	All your feature services have successfully been deactivated.

## 7.31. Call Recording

### 7.31.1. Introduction to Call Recording Function

The Sipwise C5 provides an opportunity to record call media content and store that in files.

#### Some characteristics of the Call Recording:

- Call Recording function can store both unidirectional (originating either from the caller, or from the callee) or bidirectional (combined) streams from calls, resulting in 1, 2 or 3 physical files as output respectively.
- The location and format of the files is configurable.
- File storage is planned to occur on an NFS shared folder.
- Media files can be stored on an NFS shared folder, in the central database, and/or in a cloud storage service. Storage on the local file system is also possible, but not recommended due to the increased I/O load that it can cause.
- Activation of call recording may happen generally for a *Domain / Peer / Subscriber* through the Sipwise C5 admin web interface.

#### IMPORTANT

Sipwise C5's Call Recording function is not meant for individual call interception purpose! Sipwise provides its [Lawful Interception](#) solution for that use case.

- Querying or deletion of existing recordings may happen through the REST API.
- Listing recordings of a subscriber is possible on Sipwise C5's admin web interface.

The Call Recording function is implemented using Sipwise C5's *rtpengine* module.

#### NOTE

There are 2 *rtpengine* daemons employed when call recording is enabled and active. The *main rtpengine* takes care of forwarding media packets between caller and callee, as usual, while the *secondary rtpengine* (recording) daemon is responsible for storing call data streams in the file system.

Call Recording is disabled by default. Enabling and configuration of Call Recording takes place in 2 steps:

1. Enabling the feature on the Sipwise C5 by setting configuration parameters in the main config.yml configuration file.
2. Activating the feature for a *Domain / Peer / Subscriber*.

### 7.31.2. Information on Files and Directories

Sipwise C5's Call Recording function can save recorded streams to an **NFS shared folder**, and/or into the **central database** as binary blobs, and/or upload them to a **cloud storage service** such as Amazon S3 or Google Cloud Storage. Multiple storage options can be enabled simultaneously.

#### IMPORTANT

Since the call data amount may be significant (depending on the number of calls and the duration of calls), storing recorded streams on Sipwise C5's local disk is *highly discouraged*. However if you *have to* store recorded streams as files in the local file system, please contact the Sipwise Support team in order to get the

appropriate configuration of the Call Recording function.

## NFS Storage

The NFS share gets mounted during startup of the recording daemon. If the NFS share cannot be mounted for some reason, the recording daemon will not start.

**File names** have the format: <call\_ID>-<random>-<SSRC>.<extension> by default, where:

- call\_ID: SIP Call-ID of the call being recorded
- random: is a string of random characters, unique for each recorded call. It's purpose is to avoid possible filename collisions if a Call-ID ever gets reused.
- SSRC: is the RTP SSRC for unidirectional recordings, or "mix" for the bidirectional (combined) audio.
- extension: is either "mp3" or "wav", depending on the configuration (rtengine.recording.output\_format)

There might be 1, 2 or 3 files produced as recorded streams. The **number of files** depends on the configuration:

1. `rtengine.recording.output_mixed = 'yes'` (combined stream required)  
`rtengine.recording.output_single = 'no'` (unidirectional streams not required)
2. `rtengine.recording.output_mixed = 'no'` (combined stream not required)  
`rtengine.recording.output_single = 'yes'` (unidirectional streams required)
3. `rtengine.recording.output_mixed = 'yes'` (combined stream required)  
`rtengine.recording.output_single = 'yes'` (unidirectional streams required)

The format of the file names can be configured by setting the output pattern (see below) in the configuration file.

## Database Storage

Each recorded call and each recorded stream will always produce a respective entry in the database, but normally only metadata is stored. When database storage is enabled, the actual content of the recorded stream will be stored in the database as a binary blob in addition to the metadata.

## Cloud Storage

Recorded streams can be uploaded to a supported cloud storage service. Currently Amazon S3 (AWS) and Google Cloud Storage are supported, as well as services providing a compatible API (e.g. MinIO). The names of uploaded objects follow the same pattern as the file names described under **NFS Storage**.

Required configuration parameters are described below.

### 7.31.3. Configuration

The Call Recording function can be enabled and configured on the Sipwise C5 by changing the

following configuration parameters in config.yml file:

```
rtpengine:
  ...
  recording:
    egress: no
    enable: no
    mix_method: direct
    mp3_bitrate: '48000'
    nfs_host: 192.168.1.1
    nfs_remote_path: /var/recordings
    output_chgrp: _ngcp-admin
    output_chmod: '0660'
    output_chmod_dir: '0770'
    output_chown: root
    output_dir: /var/lib/rtpengine-recording
    output_format: wav
    output_mixed: yes
    output_pattern: '%c-%r-%t'
    output_single: yes
    resample: no
    resample_to: '16000'
    spool_dir: /var/spool/rtpengine
    storage_db: no
    storage_file: yes
    storage_gcs:
      api_key: ''
      enable: no
      scope: ''
      service_account: ''
      tls_verify: yes
      uri: ''
    storage_local: no
    storage_memory: no
    storage_s3:
      access_key: ''
      enable: no
      host: ''
      path: ''
      port: 0
      region: ''
      secret_key: ''
      tls_verify: yes
  transcribe:
    enable: no
  vsc:
    pause_recording: ''
    pause_resume_recording: ''
    start_pause_resume_recording: ''
    start_recording: ''
    start_stop_recording: ''
```

```
stop_recording: ''
```

## Enabling Call Recording

Enabling the function requires changing the value of `rtengine.recording.enable` parameter to "yes". In order to make the new configuration active, it's necessary to use the following command:

```
ngcpcfg apply 'Activated call recording'
```

### Description of configuration parameters:

- **enable**: when set to "yes" Call Recording service is enabled. Default: **no**
- **egress**: when enabled, uses RTP streams leaving the Sipwise C5 platform for recording purposes, instead of received RTP
- **mix\_method**: for mixed output, select between mixing all input audio streams into a single output audio stream (**direct**), or into a multi-channel output file with one channel per stream (**channels**)
- **mp3\_bitrate**: the bit rate used when recording to MP3 format. Default: **48000** (48 kbps)
- **nfs\_host**: IP address of the NFS host that provides storage space for recorded streams. Default: **192.168.1.1**. Set to an empty string if NFS storage is not desired
- **nfs\_remote\_path**: the remote path (folder) where files of recorded streams are stored on the NFS share. Default: **/var/recordings**
- **output\_chgrp**: Unix group to change file ownership to after recording has finished. Default: **\_ngcp-admin** to allow access to the files from the web panel
- **output\_chmod**: Unix permissions to set for recorded files. Default: **0660** to allow read-only access from file owner and group members
- **output\_chmod\_dir**: Unix permissions to set for created directories. Default: **0770** to allow read-only access from file owner and group members
- **output\_chown**: Unix user to set file ownership to. Default: **root** to disallow modifications from non-administrator users
- **output\_dir**: is the local mount point for the NFS share, and thus where the final audio files will be written. Default: **/var/lib/rtengine-recording**

#### CAUTION

Normally you do not need to change the default setting. If you do change the value, please be aware that the recorded files will be written by *root* user in that directory.

- **output\_format**: possible values are **wav** (uncompressed PCM) or **mp3** (MPEG layer 3 compressed). Default: **wav**
- **output\_mixed**: **yes** means that a file containing a mixed stream of caller and callee voice data is produced. Default: **yes**
- **output\_pattern**: allows customising the format of output file names. Default: **%c-%r-%t** matching the format described above
- **output\_single**: **yes** means that a separate file for each stream direction is produced, i.e. for each stream originating from caller and callee. Default: **yes**

- **resample**: when set to **yes** the call data stream will be resampled before storing it in the file. Default: **no** to record with the original sampling rate
- **resample\_to**: the sample rate used for resampling output. Default: **16000** (16 kHz)
- **spool\_dir**: is the place for temporary metadata files that are used by the recording daemon and the main rtengine daemon for their communication. Default: **/var/spool/rtengine**

**CAUTION**

It is advisable not to alter the default setting unless there is a valid reason to do so. Sipwise has tested the Call Recording function extensively with the default configuration.

- **storage\_db**: enables or disables storage of recording content to the database. Default: **no**
- **storage\_file**: enables or disables writing of recording files, either to NFS or to the local file system. Default: **yes**
- **storage\_gcs**: contains parameters for uploads to Google Cloud Storage
  - api\_key**: if authentication via service account (OAuth2/JWT) is not in use, a secret API key must be provided to access the storage service
  - enable**: to enable content uploads to GCS
  - scope**: authentication scope to request access for, when OAuth2/JWT authentication via service account is in use. If left blank, an automatic default value will be used, for example <https://www.googleapis.com/auth/cloud-platform>
  - service\_account**: JSON service account file to use for OAuth2/JWT authentication. Must be readable by the daemon
  - tls\_verify**: can be used to disable verification of TLS certificates if a local service is used. Default: **yes**
  - uri**: full storage URI to post uploads to. Normally contains the name of the storage bucket. Example: <https://storage.googleapis.com/upload/storage/v1/b/examplebucket/o>
- **storage\_local**: when enabled, allows storage on the local file system instead of on an NFS shared folder. Default: **no**

**CAUTION**

Do not enable local file storage unless the impact on the system load has been fully considered.

- **storage\_memory**: relevant only if file storage (NFS or local) is disabled. For all non-file based remote storage options (database, cloud storage), normally recordings are first stored in a temporary file, which is then deleted after the content has been moved to its final storage place. With this option enabled, media content is temporarily stored in memory only. Default: **no**
- **storage\_s3**: options to configure uploads to S3 (Amazon AWS, etc) storage
  - access\_key**: the "access key" required to authenticate to the service
  - enable**: to enable content uploads to S3
  - host**: host name (not URI) of the storage service. May or may not have to include the name of the storage bucket. Example: **examplebucket.s3.amazonaws.com** or **minio.example.com**
  - path**: path component of the object to upload. May be left blank, for example if the host name includes the name of the bucket, or may need to set to the name of the bucket. Default blank
  - port**: allows use of a storage service running on a non-standard port. Default zero (use default)

**region**: region code to use for authentication and for uploads if required by the service. May be left blank. Example: **eu-west-2**

**secret\_key**: the secret authentication key (matching the access to) to use for authentication

**tls\_verify**: can be used to disable verification of TLS certificates if a local service is used. Default **yes**

- **transcribe**: to enable use of an external transcription service for recorded calls
- **vsc**: configures various vertical service codes to control recording from within a call (see below)

If Call Recording is enabled you can see 2 *rtengine* processes running when checking the Sipwise C5 system state with the *ngcp-service* tool:

```
root@sp1:/etc/ngcp-config# ngcp-service summary
Ok Service                               Managed Started Status
-----
...
kamailio-lb                             managed by-ha active
ngcp-voisniff                            managed by-ha active
rtengine                                  managed by-ha active
rtengine-recording                       managed by-ha active
...
```

## Activating Call Recording

Activating Call Recording for e.g. a *Subscriber*: please use Sipwise C5's admin web interface or api for this purpose. On the web interface one has to navigate as follows: *Settings Subscribers select subscriber Preferences NAT and Media Flow Control record\_call* and select one of the following options:

- Off (never): call recording disabled
- On (always): all the received or placed calls will be recorded
- On demand using VSC (initially disabled): call are not recorded by default but recording can be activated during the call using DTMF VSC codes
- On demand using VSC (initially enabled): all call are recorded by default but recording can be paused/stopped during the call using DTMF VSC codes

The screenshot shows the 'Subscribers' page in the Sipwise C5 admin interface. The table below represents the data shown in the interface:

Id	Contract	Contact E-Mail	Username	Domain	UUID	Status	Number
544	278	default-customer@default.invalid	demo	sip.yourdomain.com	66462f23-33b3-4ff6-9169-f05cee126479	active	439910001

The screenshot shows a configuration page with a sidebar on the left containing menu items: Administrators, Resellers, Customers, Contracts, Domains, Subscribers, Subscriber Profile Sets, Call List Suppressions, Billing Profiles, Billing Networks, and Profile Database. The main content area lists several settings:

- nat\_sipping**: Enable SIP OPTIONS ping (dropdown menu)
- original\_sendrecv**: Leave media direction attributes in SDP unchanged (checkbox)
- record\_call**: Record calls (dropdown menu with options: Off (never), use domain default, On (always), On demand using VSC (initially disabled), On demand using VSC (initially enabled))
- rtp\_debug**: Enables full debug logging in the RTP proxy for all calls from or to this subscriber or peer (checkbox)
- rtp\_interface**: Logical RTP interface to use for media packets (checkbox)
- sdp\_crypto\_base64\_padding**: With this flag set, Trailing '=' characters used for base64 SDP crypto padding, will be left in place (checkbox)
- set\_moh\_sendonly**: Subscriber put on hold is notified with a=sendonly in reINVITE (checkbox)
- set\_moh\_zeroconnection**: Subscriber put on hold is notified with SDP field c containing 0.0.0.0 in reINVITE (checkbox)

**NOTE**

The call recording function may be activated for a single *Subscriber*, a *Domain* and a *Peer server* in the same way: *Preferences NAT and Media Flow Control record\_call*. When activating call recording for a *Domain* or *Peer* this effectively activates the function for all subscribers that belong to the selected domain, and for all calls with a local endpoint going through the selected peer server, respectively.

Once the call recording is active, it is also possible to play a pre-recording announcement to the caller before the call is established. In order to do this set *Preferences Applications play\_announce\_before\_recording* to "Always" or "External/Internal calls only" depending if you want to play the message only for incoming calls from PSTN or only for incoming calls from local subscribers. There also exists the options "Never", and "default". In order to play the message it is mandatory to upload an audio file into *Settings Sound Sets Files early\_media announce\_before\_recording* inside the corresponding Sound Set. The *play\_announce\_before\_recording* preference can be activated hierarchically at domain, customer and subscriber level.

The screenshot shows the 'Applications' configuration page for a subscriber. The sidebar on the left includes: Sound Sets, Email Templates, Device Management, Security Bans, Malicious Calls, Number Porting, Emergency Mappings, Phonebook, Time Set, Tools, Monitoring & Statistics, and Documentation. The main content area lists several application settings:

- malicious\_call\_identification**: Malicious Call Identification (checkbox)
- play\_announce\_before\_call\_setup**: Play announcement before call setup (checkbox)
- play\_announce\_before\_cf**: Play announcement before routing to CFU/CFNA (checkbox)
- play\_announce\_before\_recording**: Play announcement before recording false (dropdown menu with options: Use domain default / contract default, Always, External calls only, Internal calls only, Never)
- play\_announce\_to\_callee**: Playback announcement to callee after he answered the call (PRO and CARRIER only) (checkbox)
- play\_emulated\_ringback\_tone**: Play an emulated ringback tone as early media after the pre-call announcements. The ringback tone is played while the final callee is ringing and only if a 180 Ringing message is received from the callee endpoint (checkbox)

The screenshot shows the 'Sound Sets' configuration page. It features a 'Create Sound Set' button, a 'Show' dropdown set to '5 entries', and a search field containing 'ddd'. Below is a table with the following data:

#	Reseller	Customer	Name	Description	Parent	Expose to Customer	Actions
6	default	default-customer@default.invalid	ddd	ddd		0	Edit Delete Files

Showing 1 to 1 of 1 entries (filtered from 16 total entries)

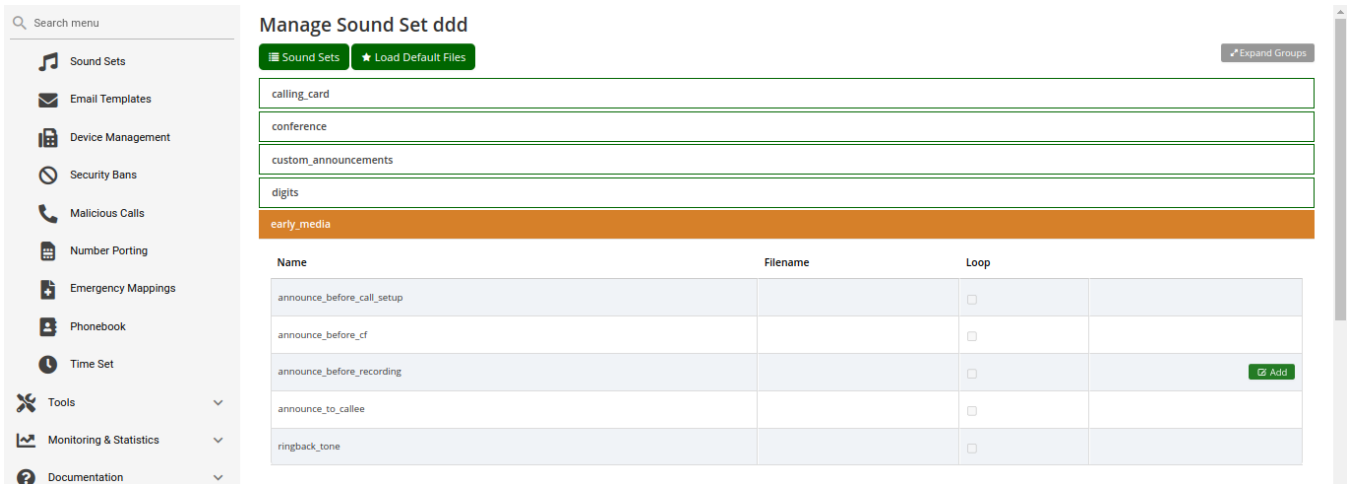

The call recording can also be activated and terminated during the call using VCS codes. In particular, the possible actions are:

- `pause_recording`: the recording is put on pause, the recording continues but no audio is captured (default code not assigned)
- `pause_resume_recording`: the recording is put on pause or resumed depending on the previous state (default code not assigned)
- `start_pause_resume_recording`: the recording is put on pause, resumed or started depending on the previous state (default code not assigned)
- `start_recording`: the recording is started (default code not assigned)
- `start_stop_recording`: the recording is started or stopped depending on the previous state (default code not assigned)
- `stop_recording`: the recording is stopped (default code not assigned)

To customize the default VSC codes, see section `'rtengine.recording.vsc'` in `'config.yml'` file. An acoustic signal will inform the participants of the beginning/ending of the registration. The acoustic signal can be customized editing the `'kamailio.proxy.vcs_recording_announce_file'` config.yml option. It is possible to **list existing call recordings** of a *Subscriber* through the admin web interface of the Sipwise C5. In order to do so, please navigate to: *Settings* *Subscribers* *select subscriber* *Details* *Call Recordings*

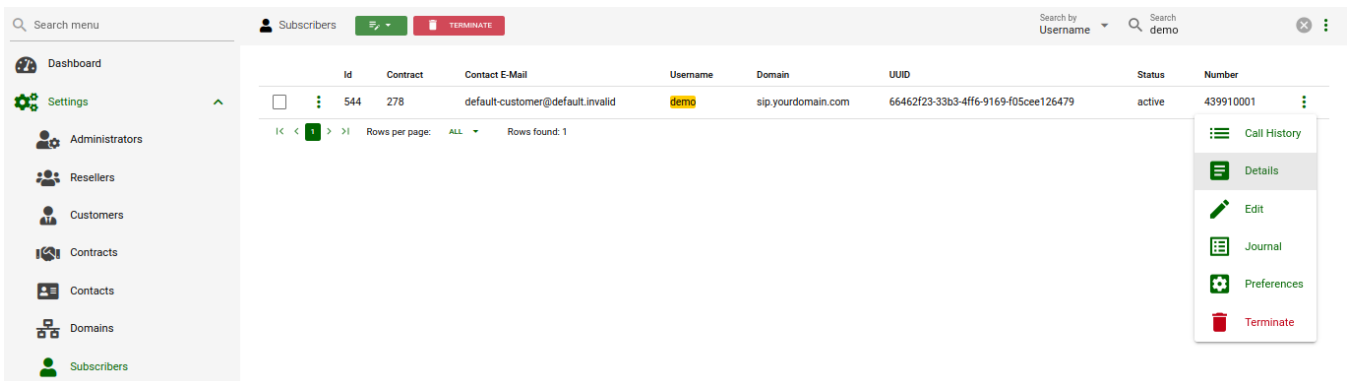

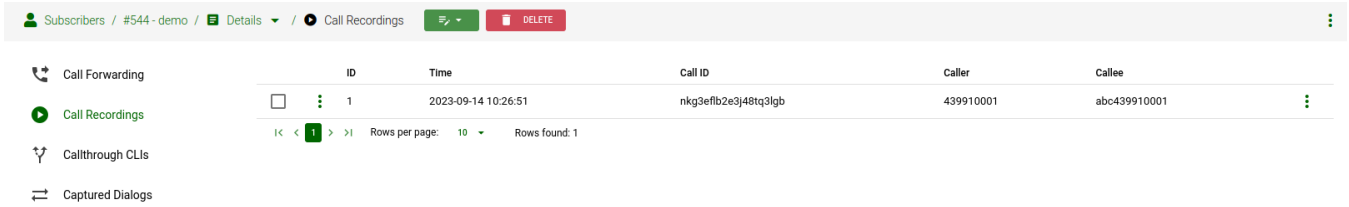

If you select an item in the list, besides the main properties such as the time of call and the SIP Call-ID, you can retrieve the details of the related call (press the *Call Details* button), get the list of recorded files (press the *Recorded Files* button) or *Delete* the recorded call.

When selecting *Call Details* you will see the most important accounting data of the call. Furthermore you can see the SIP *Call Flow* or the complete *Call Details* if you press the respective buttons.

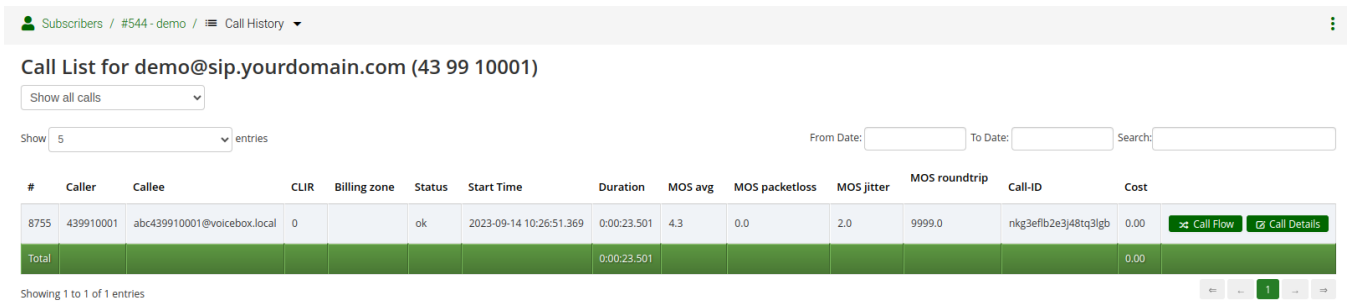
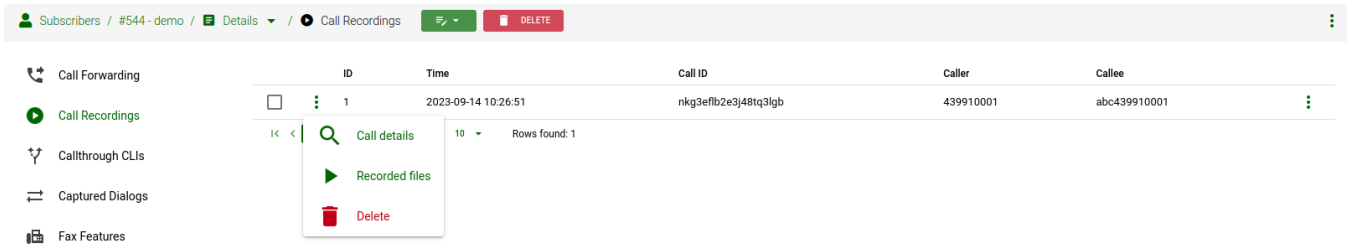

When navigating to *Recorded Files* of a call you will be presented with a list of files. For each file item:

- type of stream is shown, that can be either "mixed" (combined voice data), or "single" (voice data of caller or callee)
- file format is shown, that can be either "wav", or "mp3"
- you can download the file by pressing the *Play* button



Figure 114. Listing Files for a Recording

### 7.31.4. REST API

The Sipwise C5 REST API provides methods for querying and deletion of existing recording data. The full documentation of the available API methods is available on the admin web interface of the Sipwise C5, as usual.

The following API methods are provided for managing Call Recordings:

- CallRecordings:
  - Provides information about the calls recorded in the system; can also be used to delete a recording entry
  - accessible by the path: `/api/callrecordings` (collection) or `/api/callrecordings/id` (single item)
  - Supported HTTP methods: OPTIONS, GET, DELETE
- CallRecordingStreams:
  - Provides information about recorded streams, such as start time, end time, format, mixed/single type, etc.; can also be used to delete a recorded stream
  - accessible by the path: `/api/callrecordingstreams` (collection) or `/api/callrecordingstreams/id` (single item)
  - Supported HTTP methods: OPTIONS, GET, DELETE
- CallRecordingFiles:
  - Provides information about recorded streams, such as start time, end time, format, mixed/single type, etc.; additionally returns the file content too
  - accessible by the path: `/api/callrecordingfiles` (collection) or `/api/callrecordingfiles/id` (single item)
  - Supported HTTP methods: OPTIONS, GET

### 7.31.5. Pre-Recording Announcement

Many country regulations require that an informative announcement is played to the caller before the call is actually recorded. The Sipwise C5 allows you to configure your own custom announcement with few simple steps.

First create a system sound set for the feature. In *Settings Sound Sets* either use your already existing *Sound Set* or create a new *Sound Set* and then assign it to your domain or subscribers. In the *Sound Set* there is an announcement *early\_media announce\_before\_recording* for that purpose.

Once the *Sound Set* is created the subscriber's preference *play\_announce\_before\_recording* of the callee must be enabled under *Subscriber Preferences Applications* menu. The same parameter can be set in the Domain's or Customer's preferences to enable this feature for all its subscribers.

**NOTE** | The announcement will be played to the caller before the call is routed to the callee.

#### **IMPORTANT**

In case of **CFU** or **CFNA** with Pre-Recording Announcement feature enabled on both the forwarder and the final callee, only the Announcement of the final callee will be played to the caller. In case of **CFB** and **CFT**, instead, the announcement of the forwarder will be played first, then the announcement of final callee will be played after the call forward is executed.

## 7.32. Media Transcoding and Transrating

### 7.32.1. Overview

Sipwise C5 offers the capability to convert RTP media between several supported codecs, a feature known as transcoding. While this feature is always available on Sipwise C5, it's engaged only when a subscriber, peer, or domain is explicitly configured for it. By default, Sipwise C5 lets RTP endpoints negotiate the codec to use among themselves without interfering.

#### IMPORTANT

Media transcoding is a relatively CPU-intensive feature. As such, each individual node of a Sipwise C5 performing media transcoding can only support a limited number of concurrent calls for which transcoding is active.

### 7.32.2. Supported Codecs

The following audio codecs, which are commonly found in use by SIP/RTP clients, are currently supported for transcoding.

- G.711 ( $\mu$ -Law and a-Law)
- G.722
- G.723.1
- G.729
- GSM
- AMR (narrowband and wideband, the latter also known as AMR-WB)
- Opus
- Speex
- DTMF event packets (**telephone-event**)
- Comfort noise

Some codecs operate at different sampling rates than other codecs. If transcoding happens between two such codecs, the audio will be resampled as necessary. Similarly, if transcoding happens between a mono (1-channel) and a stereo (2-channel) codec, the audio will be up-mixed and down-mixed as necessary.

### 7.32.3. Configuration

Transcoding can be engaged for individual subscribers, peers, or domains on their respective preferences page in the Sipwise C5 admin web interface.

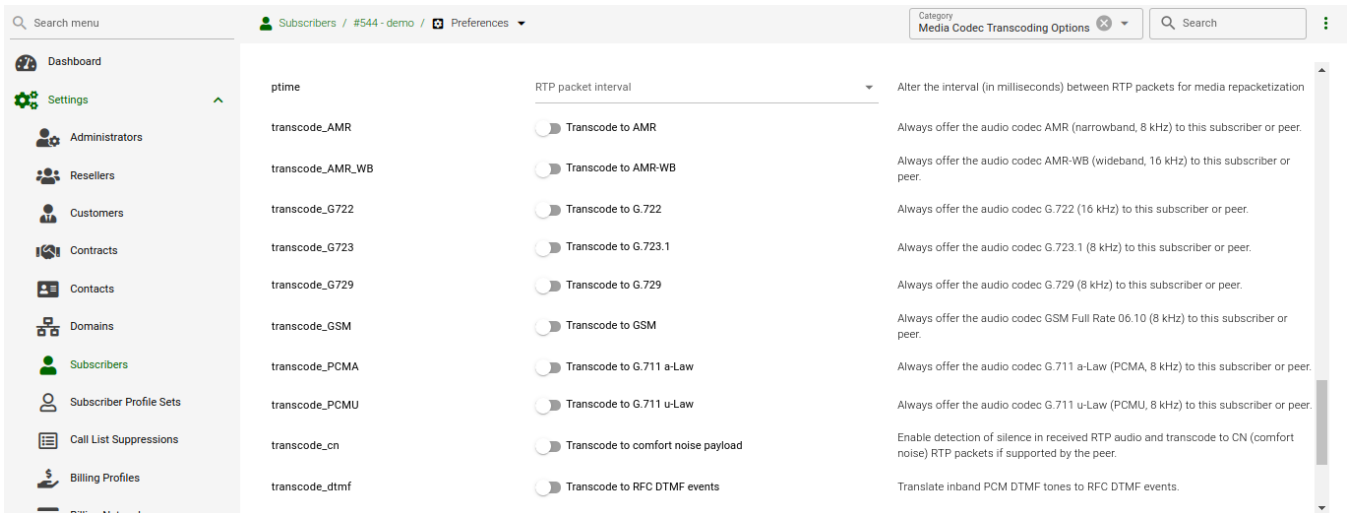

Figure 115. Transcoding Configuration

Setting any of the transcoding options for a domain makes it affect all the subscribers in this domain.

Individual options are described below.

### ptime

Packetisation time in milliseconds. Normally the Sipwise C5 lets the RTP endpoints select and negotiate the packetisation time they want to use. Setting this option to anything other than unchanged will engage transrating via the transcoding engine towards this subscriber or peer, even if none of the other transcoding options are set, in which case the media will be transrated (repacketised).

For example, setting this to 40 ms would mean that each RTP packet sent towards this subscriber or peer would contain 40 milliseconds worth of audio, even if the other side of the call sends media that is packetised differently. It would also make the Sipwise C5 indicate towards this subscriber or peer that it would prefer to receive audio in 40 millisecond packets (through the a=ptime SDP attribute).

### transcode\_...

Enabling one of these options adds the selected codecs to the list of codecs offered to this subscriber or peer, even if the original list of offered codecs did not include it. If this additional codec ends up being accepted by this subscriber or peer, then it will be transcoding to the first supported codec that was originally offered.

For example, if a calling RTP client A indicates support for PCMA (G.711 a-Law) as well as G.722, and calls a subscriber B that is configured for transcoding to G.729, then subscriber B would be offered PCMA, G.722, and G.729 by the Sipwise C5. If subscriber B then accepts G.729 and starts sending G.729, the Sipwise C5 would engage its transcoding engine and transcode the audio to PCMA (because PCMA and not G.722 was the codec preferred by A) before forwarding it to A. Vice versa, PCMA arriving from A would be transcoded to G.729 before being sent to B. (If B were to reject G.729 and instead starts to send PCMA or G.722, no transcoding would happen.)

Notes on individual codecs:

- **AMR** is available in both narrowband (AMR operating at 8 kHz) and wideband (AMR-WB operating at 16 kHz) variants. These are distinct codecs and can be configured for transcoding separately or together.

- **Opus** always operates at 48 kHz, but is supported in both mono and stereo (1 and 2 audio channels respectively). Both can be offered at the same time if so desired.
- **Speex** is supported at sampling rates of 8, 16, and 32 kHz. These can be configured separately for transcoding, or together.
- **DTMF** is not an actual audio codec, but rather represents transcoding between DTMF event packets and in-band DTMF audio tones. This is described in more detail below.
- **CN** refers to comfort noise payloads. More information about this is below.

### ...\_bitrate

Some codecs (Opus and G.723.1 in particular) can be configured for different bitrates, which would impact the amount of network bandwidth they use, as well as the audio quality produced. For Opus, different bitrates can be selected for their mono and stereo instances. Selecting a bitrate has no effect if transcoding to the respective codec is not engaged.

### AMR-specific Options

AMR and AMR-WB support dynamic mode switching (adapting the bitrate) during runtime. The configurable bitrate therefore is only the initial bitrate at which the encoder is started, and is further constrained by the **mode-set** option.

The **mode-set** is a list of comma-separated AMR modes, e.g. **0,1,2,3**. If a **mode-set** is received from a remote peer, then only the modes (bitrates) given in the list will be used for the encoder. If a specific bitrate is also configured, then this bitrate will be used as the highest possible starting bitrate. If this bitrate is not allowed by the **mode-set**, then the next lower bitrate will be used. If no lower bitrates are permitted, then the next higher bitrate will be used.

For outgoing AMR offers, a **mode-set** can be configured in the preferences page, and it will be honoured just like a **mode-set** that is received from a remote peer. A remote AMR peer may support only a specific subset of AMR modes, which would need to be configured in the **mode-set**. The Sipwise C5 supports encoding and decoding all possible AMR modes.

If no **mode-set** is received nor configured, then all bitrates are permitted.

AMR has two basic payload variants: **bandwidth-efficient** and **octet-aligned**. A remote AMR peer may support only one of them, in which case the correct one must be configured in the preferences. The default is **bandwidth-efficient**. The Sipwise C5 supports sending and receiving both and will honour the request made by a remote AMR peer for one or the other.

Further options that may be required by a remote AMR peer to restrict permissible mode changes are: **mode-change-period** restricts mode changes to be made only every other packet if set to **2** (the default is **1**); **mode-change-capability** advertises the capability to restrict the modes changes as such without actually restricting them; and **mode-change-neighbor** restricts mode changes to be made only to neighbouring modes if enabled (the default is disabled).

AMR supports requesting specific encoder modes from the remote peer via **Codec Mode Requests** (CMR). The Sipwise C5 will honour a CMR received from the remote peer and switch encoder mode accordingly. Then optionally, if no further CMRs are received from the peer, the Sipwise C5 can then try to increase encoder bitrate again to improve audio quality. This can be enabled by setting the **mode change interval** preference to non-zero. It specifies an interval in milliseconds at which to switch to a higher encoder bitrate if no CMR was received during that time, and if a higher bitrate is available and

allowed by the **mode-set**.

In the opposite direction, the Sipwise C5 can optionally request higher bitrates from the remote peer by sending CMRs out. This can be enabled by setting the **CMR interval** preference to non-zero. It specifies an interval in milliseconds at which the Sipwise C5 will request a higher bitrate from the remote encoder if a higher bitrate is available and it was not being used during that time.

### **always\_transcode**

Setting this flag instructs the Sipwise C5 to always engage transcoding to the first (preferred) codec indicated by an RTP endpoint, even if another codec is available that is supported by both parties to a call. Enabling this flag can potentially engage the transcoding engine for a call even if none of the other transcoding options are set.

For example: Subscriber A is calling subscriber B. Subscriber A is indicating support for PCMA and G.722. Subscriber B answers the call, rejects PCMA but accepts G.722, and starts sending G.722 to A. Normally the Sipwise C5 would not get involved and would let G.722 pass between A and B. But if subscriber B has the `always_transcode` flag set, the Sipwise C5 would now start transcoding the G.722 sent by B into PCMA before forwarding it to A, because PCMA was indicated as the preferred codec by A. Vice versa, PCMA arriving from A would be transcoded into G.722 and then forwarded to B.

### **DTMF transcoding**

The Sipwise C5 supports transcoding between DTMF event packets (using the RTP telephone-event type payload) and DTMF tones carried in-band in the audio stream. DTMF transcoding is supported in both directions: transcoding DTMF event packets to DTMF tones, and DTMF tones in an audio stream and transcoding them to DTMF event packets.

Support for DTMF transcoding can be enabled in one of two ways:

- Enabling the setting `transcode_dtmf` for a subscriber, peer, or domain. This is useful if the subscriber, peer, or domain requires support for DTMF event packets, but the calling entity might only support DTMF tones carried in-band in the audio stream.
- Enabling the setting `always_transcode` for a subscriber, peer, or domain. This is useful for the reverse case: if the subscriber, peer, or domain might only support DTMF tones carried in-band in the audio stream, but the calling entity requires support for DTMF event packets.

Enabling DTMF transcoding for any call requires that all audio passes through the transcoding engine, as well as a DSP for detecting DTMF tones in one direction. This carries an additional performance impact with it, and so DTMF transcoding should only be enabled when absolutely necessary.

### **DTMF conversion of INFO messages**

The Sipwise C5 supports the conversion of SIP INFO messages with `application/dtmf-relay` payload to DTMF event or PCM DTMF inband tone, depending on whether the destination participant supports the telephone-event RTP payload type or not. DTMF conversion of INFO messages works only in one way direction: DTMF events or PCM DTMF inband tones are not converted back to DTMF INFO messages.

The preference `kamailio.proxy.allow_info_method` has to be set to `yes` in `config.yml` in order to make the DTMF INFO message conversion working.

Enabling DTMF conversion of INFO messages for any call requires that all audio passes through the transcoding engine, as well as a DSP for detecting DTMF tones in one direction. This carries an

additional performance impact with it, and so it should only be enabled when absolutely necessary.

**NOTE**

At the moment this feature is for internal use only. External generated INFO messages will be not converted but passed through.

**Comfort Noise**

RTP supports a special payload format for carrying comfort noise (CN) audio without having to encode it as actual audio. Support for CN is optional and negotiation is normally left up to the endpoints. If CN transcoding is enabled, the Sipwise C5 can transcode CN payloads to audio noise and vice versa.

When active and when CN is supported by one endpoint but not the other, any received CN payloads are converted to audio noise and this noise is then inserted into the audio stream. In the reverse direction, the Sipwise C5 can optionally detect silence audio frames and then convert these to predefined CN payloads.

To enable silence detection, the setting `rtengine.silence_detect` in `config.yml` must be set to a non-zero value. This value denotes the silence detection threshold in percent and therefore must be between 0.0 and 100.0. Any audio samples that are lower than the configured threshold will be as silence, and if all audio samples in an audio frame are detected as silence, then that frame will be replaced by a CN frame. To only replace audio frames that contain complete silence with CN frames, a very low but non-zero value can be used here, such as 0.1%.

**NOTE**

Certain audio codecs always leave a residual DC offset in the audio samples, even when encoding complete silence. G.711 a-Law (PCMA) is one such example, for which the minimum silence detection threshold is 0.013%.

When a silence audio frame is replaced by a CN frame, the generated CN payload is not based on the audio that is being replaced, but rather taken from the static and predefined setting `rtengine.cn_payload` in `config.yml`. This is a list of comfort noise parameters according to RFC 3389. The first value in the list is mandatory and denotes the volume of the noise payload in negative dBov (meaning larger values result in quieter audio, with zero being the loudest), while all subsequent values are optional and denote spectral information about the noise. The default is the single value 32, which describes noise with a volume of -32 dBov without any spectral information.

### 7.32.4. T.38 transcoding

In addition to transcoding between audio codecs, the Sipwise C5 supports transcoding between T.38 fax transmissions (over UDPTL transport) and T.30 fax data over regular audio channels. The audio codec commonly used to carry T.30 data is G.711, but any other audio codec that is supported for transcoding can also be used, provided it offers a high enough bitrate and audio quality.

Two settings to control T.38 transcoding are available for subscribers, peers, and domains:

- The setting `t38_decode` instructs the Sipwise C5 to accept an offered T.38 session towards the subscriber, peer, or domain, and translate it into a regular audio call carrying T.30 fax data. By default, G.711 (both  $\mu$ -Law and a-Law) will be offered. If any other codecs are selected through the `transcode_...` options, then only those codecs will be offered and the G.711 default will be omitted. Non-T.38 offers are not affected by this settings.
- The setting `t38_force` forces any audio call towards this subscriber, peer, or domain to be translated to a T.38 session, regardless of whether the audio media actually carries T.30 fax data or not. This is useful if it is known that the remote destination is a fax endpoint supporting T.38.

### 7.32.5. DTX jitter buffer

DTX is short for **discontinuous transmission** and describes an event during which a remote RTP client intermittently stops sending RTP. Some codecs explicitly support this as a feature (e.g. AMR and AMR-WB) while in other instances a sending RTP client may erroneously produce gaps in the RTP stream. If a receiving RTP client is not expecting such a behaviour, the resulting audio output may have unpleasant characteristics, such as stuttering or dropping the audio to complete silence.

By default the Sipwise C5 will not attempt to correct such a DTX behaviour and will simply pass through any DTX gaps untouched. However, for any call with active audio transcoding, the Sipwise C5 can be configured to enable a DTX jitter buffer in order to fill in DTX gaps with comfort noise to produce a steady output RTP stream.

#### Configuration

The master switch to enable the DTX jitter buffer is found in `config.yml` under the setting `rtengine.dtx_delay`. This value denotes the processing delay in milliseconds (i.e. the length of the jitter buffer) and should be set to just slightly higher than the highest expected ingress jitter. The default value of zero disables the DTX buffer.

When a DTX event is detected, the gap will be filled in using an RFC 3389 compliant comfort noise generator. The parameters for this generator are set under `rtengine.dtx_cn_params`. The default is just a single value of 35, specifying white noise at -35 dBov. Higher numbers lead to quieter noise. Subsequent numbers (i.e. from the second number onward) are optional spectral parameters.

The maximum duration for which comfort noise should be generated can be set using `rtengine.max_dtx` in seconds. The default is unlimited (zero).

If an incoming RTP stream experiences a timer drift (i.e. the RTP clock runs slower or faster than expected), then the timer handling the DTX buffer will be shifted forward or backward by `rtengine.dtx_shift` milliseconds (default 5). Timer drifts can lead to DTX buffer overflows, which are detected if more than `rtengine.dtx_buffer` packets with an RTP delay of more than `rtengine.dtx_lag` milliseconds are held in the buffer (defaults 10 and 100, respectively).

AMR and AMR-WB explicitly support DTX and provide their own comfort noise format (called SID) to fill in DTX gaps. If `rtengine.amr_dtx` is set to `native` (the default) then the native AMR SID/CN generator will be used to produce the noise to fill in DTX gaps. If this setting is set to `CN` then the generic CN generator (which is used for other codecs) is used instead.

## 7.33. Transcription Services

[Voicemail messages](#) as well as recordings from the [call recording](#) feature can optionally be sent to an external service to be transcribed into a textual form.

As these services are not provided directly by the Sipwise Sipwise C5, it is the responsibility of the operator of the platform to consider all possible implications (e.g. related to privacy laws) of sending voice data to an external service and have it transcribed.

### 7.33.1. Primary Configuration

The interaction with the external transcription service is facilitated by the platform's task-agent, and as such the task-agent service must be enabled in config.yml:

```
task_agent:
  enable: yes
```

Furthermore, the transcription component itself must be configured:

```
transcripts:
  service: whisper_local
  node: '*|state=active,role=web'
  auth: api_key
  api_key: ''
  oauth:
    algorithm: RS256
    scope: https://www.googleapis.com/auth/cloud-platform
    service_key_file: /etc/ngcp-config/shared-files/.....json
    uri: https://oauth2.googleapis.com/token
  google:
    ...
  lemonfox:
    ...
  openai:
    ...
  whisper_local:
    ...
```

The **service** parameter is used to select from one of the supported transcription services. Currently this is OpenAI, Google, or Lemonfox. The **whisper\_local** service is available as an experimental proof-of-concept provider using a locally-run instance of Whisper and is not meant for production use.

The **node** parameter is in task-agent syntax and is relevant in multi-node platform setups (i.e. PRO and CARRIER). It describes one or several nodes of the platform to which to delegate the transcription task to. As this typically involves communicating with an external API, the node in question must be able to access that API. The default nominates the active "web" node to facilitate this.

#### NOTE

Load sharing between different nodes of a CARRIER installation is not currently available, and so use of this feature on a CARRIER platform currently requires a custom

setup.

Authentication to the external service happens either with a secret API key (set `auth` to `api_key` and set the key as `api_key`), or via OAuth2/JWT (set `auth` to `oauth`). Which method to choose is dictated by the transcription service being used.

### OAuth2/JWT Configuration

Use of OAuth2 requires a service account key file in JSON format provided by the transcription service. This key file contains several pieces of information required by the OAuth2 mechanism, most importantly a client identifier and a cryptographic private key. The configuration parameter `service_key_file` must point to this JSON file.

The `algorithm` must be set to match the type of private key in the key file (default `RS256` for RSA+SHA-256). The `scope` is the authentication scope to request access for, and the `uri` is the endpoint to request JWT tokens from. The defaults are usable for Google Cloud Services.

## 7.33.2. Google Cloud Speech-to-Text

The Google transcription service supports the following options:

```
google:
  audio:
    channels: 1
    sample_rate: 16000
  bucket: ''
  config:
    alternativeLanguageCodes:
      - es
      - de
      - it
    enableAutomaticPunctuation: 'true'
    enableSeparateRecognitionPerChannel: 'false'
    languageCode: en
```

The `audio` parameters describe the audio format used towards the Google service. The default is single-channel 16 kHz PCM. Audio in other formats is converted to this format before being sent to Google.

The `bucket` setting is needed to support transcription of audio longer than 1 minute or 10 MB. If set, audio data will be uploaded to the given Google Cloud Storage bucket first, and transcription will then be requested of the uploaded object in the storage bucket. Afterwards, the object will be deleted from the bucket.

All keys under `config` are given verbatim to the service as part of the transcription request. At least one language code must be given, and up to 3 alternative languages can be set.

## 7.33.3. OpenAI Speech-to-Text

The OpenAI API supports these options:

```
openai:
  language: ''
  model: gpt-4o-transcribe
  prompt: ''
  temperature: 0
```

These options are sent to OpenAI as part of the transcription request. At least the model must be given. The language is a hint and can improve detection speed and accuracy. The temperature is a number between 0.0 and 1.0 and describes the randomness of the output, with higher values meaning more random. A value of zero enabled automatic detection. The prompt is optional and can be a clue to the AI about what is being transcribed.

### 7.33.4. Lemonfox Speech-to-Text

Lemonfox provides an OpenAI-compatible API with some extra features. The configuration options are:

```
lemonfox:
  language: ''
  prompt: ''
  translate: no
```

As with OpenAI, language and prompt are optional. If **translate** is set to **yes** then the result will be translated to English.

### 7.33.5. Voicemail Transcripts

To enable transcription of voicemail messages, set:

```
asterisk:
  voicemail:
    transcribe:
      enable: yes
      transcribed_mailbody: You have received a new message from
${VM_CALLERID} in voicebox
      ${VM_MAILBOX} on ${VM_DATE}.\nThe contents of the message are
"@@TRANSCRIPT@@"
```

The transcript of each voicemail message is stored in the central database, together with the entry for the voicemail message itself. If email notifications for new voicemail messages are configured, then the string from **transcribed\_mailbody** will be used instead of the regular **mailbody** string for the body of outgoing emails. This allows inclusion of the special template string **@@TRANSCRIPT@@** which will be replaced with the contents of the transcript.

#### NOTE

Inclusion of the transcript in a voicemail email message necessarily incurs a delay in delivery of the email, as the message has to wait until the transcription has been completed.

### 7.33.6. Transcripts for Call Recordings

To transcribe call recordings, set the following:

```
rtengine:  
  recording:  
    transcribe:  
      enable: yes
```

The transcripts will be stored in the central database, together with the entry for each recorded stream.

## 7.34. Announcement Before Call Setup

This feature allows a callee to play a custom announcement to the caller every time they receive a call. The announcement is played in early media mode, therefore it can be used as a simple business welcome message or to inform the caller about a different cost of the call before it will be actually charged.

**NOTE**

It can also be played in so-called established mode, controlled by the `conn_type` subscriber's preference. In this case the call will be automatically answered with 200OK and the announcement will be played in the established two-way media session. After that the system will continue to interconnect a caller with the final destination. And the ring-back tone in this case gets emulated.

The configuration of the announcement is similar to the activation of [Pre-Recording Announcement](#) and it requires few simple steps.

First create a system sound set for the feature. In *Settings Sound Sets* either use your already existing *Sound Set* or create a new *Sound Set* and then assign it to your domain or subscribers. In the *Sound Set* there is an announcement *early\_media\_announce\_before\_call\_setup* for that purpose.

Once the *Sound Set* is created the subscriber's preference *play\_announce\_before\_call\_setup* must be enabled under *Subscriber Preferences Applications* menu. The same parameter can be set in the Domain's or Customer's preferences to enable this feature for all its subscribers.

**NOTE**

The announcement will be played to the caller before the call is routed to the callee.

**IMPORTANT**

The announcement before call setup will always be played, even during the call forward or deflection (302 Moved) cases. That means, if the CF announcement is enabled on the call forward owner, then this will be played first, and if there is the announcement before call setup configured on the final destination, then this will be played afterwards. This behavior has been changed beginning from the mr13.4+ Sipwise C5 version.

**NOTE**

This feature and *Pre-Recording Announcement* can be activated at the same time. In this case the *Announcement Before Call Setup* will be played first. If it's enabled in common with the CF announcement, then the order will be: 1. CF announcement is played; 2. Then the announcement before call setup is played; 3. Eventually the recording announcement is played.

## 7.35. Emulated Ringback Tone

An usual problem linked to the activation of pre-call announcements, like for example [Announcement Before Call Setup](#), [Pre-Recording Announcement](#), Announcement Before Call Forward, is the impossibility of the caller device or provider to generate again the ringback tones after the early media announcement is terminated. This usually happens even if a new '180 Ringing' message is sent back to the caller.

To overcome this problem the Sipwise C5 makes it possible to play a pre-recorded ringback tone to the caller party in early media mode. This feature can be activated on the caller Subscriber or Peer where the tone has to be played. The emulated ringback is played in a loop and it is stopped if one of the following conditions happens:

- a '183 Progress' message is sent back by the callee, this because the callee most likely would like to play an announcement in early media mode
- a '200 OK' message is sent back by the callee
- the call fails

The configuration of the announcement is similar to the activation of [Pre-Recording Announcement](#) and it requires few simple steps.

First create a system sound set for the feature. In *Settings Sound Sets* either use your already existing *Sound Set* or create a new *Sound Set* and then assign it to your domain or subscriber. In the *Sound Set* there is an announcement *early\_media\_ringback\_tone* for that purpose.

Once the *Sound Set* is created the caller subscriber's preference *play\_emulated\_ringback\_tone* must be enabled under *Subscriber Preferences Applications* menu. The same parameter can be set in the Domain's or Customer's preferences to enable this feature for all its subscribers. It can also be enabled on Peer's preferences to activate the feature when the call is coming from the peer.

By default the callee's soundset is used to generate the emulated ringback tone. If you prefer to use the ringback tone uploaded in the caller soundset you have to set `config.yml` preference *kamailio.proxy.play\_ringback\_tone\_of\_caller* to 'yes'.

The same feature can be used to play back to the caller a music on hold or other announcements while the callee endpoint is ringing. To do that just upload the media you prefer instead of a ringback tone.

### IMPORTANT

The callee has to send a '180 Ringing' message to trigger the emulated ring back tone to start.

### NOTE

The generation of the emulated ringback tone is currently limited to two specific scenarios: in the one specified above after a pre-call announcement and in a TPCC initiated call where the caller is already in conversation.

## 7.36. Store Recent Calls and Redial

The Sipwise C5 allows to store the number of the last incoming and outgoing calls of each subscriber. To enable the feature, edit `config.yml` file and enable there `kamailio: store_recentcalls: yes`. Only the last incoming and outgoing call is stored.

Each subscriber can interact with their own personal stored records using Vertical Service Codes (see [VSC](#)). In particular a subscriber can:

- redial the last dialed number (this feature has to be enabled for the each subscriber/domain using preference `last_number_redial`);
- hear a voice announcement of the last caller's number, then press the key defined in `semsvsc callback_last_caller_confirmation_key` preference of `/etc/ngcp-config/config.yml` to return the call;
- return the call to the last caller's number without hearing the number announcement;
- delete the personal stored records of any recent calls to and from him.

**NOTE** | It is not possible return a call if the caller's number is unavailable (e.g. anonymous calls).

### 7.36.1. Configuring Recent Calls Sound Sets

Sound Sets can be defined in `SettingsSound Sets`. To create a new Sound Set, click *Create Sound Set*. Then click the *Files* button.

The screenshot displays the 'Sound Sets' configuration interface. On the left is a sidebar with navigation options. The main area shows a 'Sound Sets' table with columns: #, Reseller, Customer, Name, Description, Parent, and Expose to Customer. Below this is a table of sound set files with columns: Name, Filename, and Loop. The 'recent\_calls' sound set is highlighted in orange.

Name	Filename	Loop
recent_call_anonymous		<input type="checkbox"/>
recent_call_confirmation		<input type="checkbox"/>
recent_call_deleted		<input type="checkbox"/>
recent_call_empty		<input type="checkbox"/>
recent_call_play_number		<input type="checkbox"/>

Upload the following files:

Table 22. Recent Calls Sound Sets

Handle	Message played
recent_call_play_number	The last call you received was from ....

Handle	Message played
recent_call_confirmation	To call back this number press key ...
recent_call_anonymous	The last caller didn't share his number, you can not return the call to this person.
recent_call_empty	Your recent call history is empty.
recent_call_deleted	Your recent call history has been successfully deleted.

**NOTE** | You may use 8 or 16 bit mono WAV audio files.

Then set the preference *sound\_set* on the Domain or Subscriber level in order to assign the Sound Set (as usual the subscriber preference overrides the domain one).

### 7.36.2. Advanced configuration

By default the expiration time for the most recent incoming and outgoing call per subscriber are 3600 seconds (1 hour) and 86400 seconds (1 day) respectively. If you wish to prolong or shorten the expiration time open `constants.yml` and set there `recentcalls: expire: 3600` and `recentcalls: out_expire: 86400` to a new value, then issue `ngcpcfg apply "recentcalls expire modification"` afterwards.

## 7.37. Time sets management

### 7.37.1. Time sets specifications and data description

The Sipwise C5 provides an administrative WEB and API interface to manage time sets.

Supported fields, input and output format are based on [iCalendar EVENT](#) specification.

Not all iCalendar and EVENT properties are supported, but those that are used for time points and periods definition or stated mandatory by the specification:

- CALENDAR supported properties:

NAME

- EVENT supported properties:

SUMMARY

DTSTART

DTEND

RRULE

Important to mention that current implementation does not support these EVENT properties:

- DTSTAMP ( UID is used in generated calendar ics file, both UID and DTSTAMP are ignored during uploading calendar file );
- DURATION ( DTEND is used );
- RDATE
- EXDATE
- PRIORITY

Main EVENT property, that is used for time points and periods definition is RRULE. Current time sets implementation supports all properties described in the [RRULE specification](#) except WKST.

Default value for week start is MO (Monday).

### 7.37.2. Web interface for the time sets

The time sets management section is provided in two variants. One is the main time sets management section and other is a chapter on reseller details page. Variants have minor differences. Functionality will be explained using the time sets dedicated interface. Differences will be explained below.

Time set can be created using creation form. On time sets management interface press button "Create Time Set Entry":

Time Set / + Add SAVE CLOSE

Reseller\* default

Name\* my\_ncos\_timeset

Calendarfile

"Reseller" field is mandatory. "Name" field should be defined, if iCalendar (ics) file is not going to be uploaded or file doesn't have NAME property for the CALENDAR entry. If both NAME in the uploaded iCalendar (ics) file and form field "Name" aren't empty then value from the form field will be taken.

Created time set can be modified:

Time Set + ADD DELETE

Id	Reseller	Name
1	default	my_ncos_timeset

Rows per page: 10 Rows found: 1

Edit Events Delete

or deleted:

Time Set + ADD DELETE

Id	Reseller	Name
3	default	my_ncos_timeset

Rows per page: 10 Rows found: 1

Edit Events Delete

#### NOTE

If calendar ics file will be uploaded to edit time set, all presented events will be deleted and events from the uploaded file will be added after it.

### 7.37.3. Web interface for the time set events

A time set can contain set of events. Each time set event will be used to generate CALENDAR EVENT entry in the generated iCalendar file. All fields in the time set event forms represent properties of the iCalendar EVENT component.

To manage time set events press "Events" button of the desired time set.

Time Set + ADD DELETE

Id	Reseller	Name
3	default	my_ncos_timeset

Rows per page: 10 Rows found: 1

Edit Events Delete

Events management section will appear:

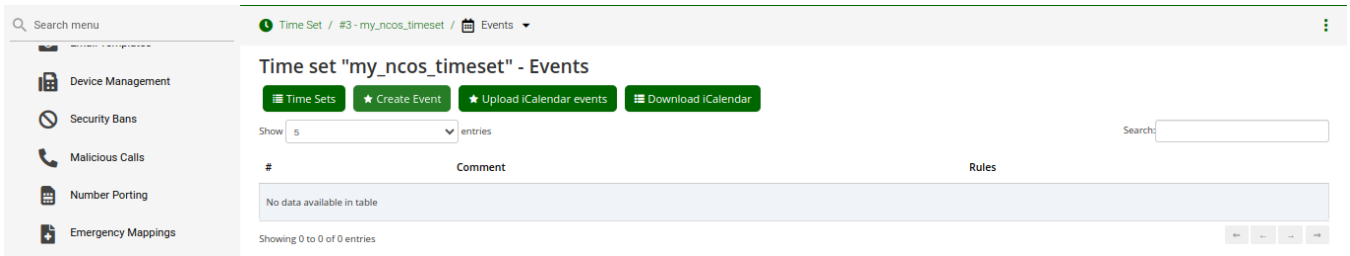

To create event press "Create Event" button. And the form to create event will be shown:

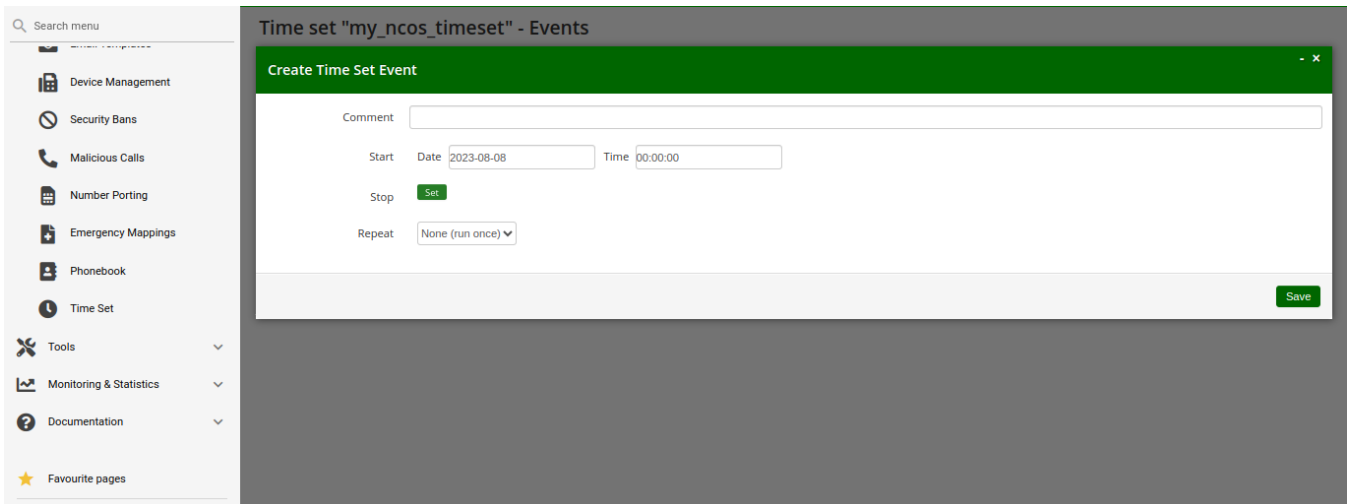

### Time set event form fields explanation

"Start" field reflects DTSTART property of the EVENT. "Start" is mandatory and by default is set to the start of the current day. "Start" value format is datetime. "Stop" field reflects DTEND property of the EVENT. For the events within recurrence "Stop" will define duration of each iteration. To specify "Stop" datetime, press button "Set". Fields to enter DTEND date and time will appear:

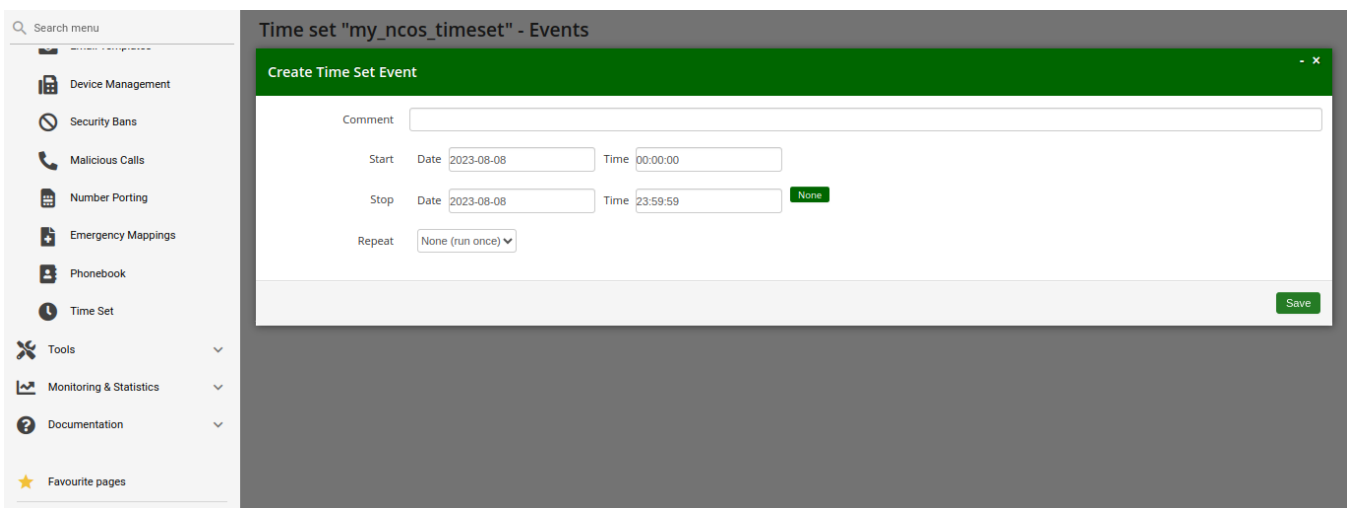

To return "Stop" field to the empty value press button "None". Value in the form fields will be preserved, but newly created EVENT will have empty DTEND property. The rest of the fields in the form are optional. Most of them are not visible by default and will be shown if requested by user or required by data into other fields.

RRULE property of the EVENT is a recurrence rule and defines set of the iterations for the EVENT. To

customize recurrence rule for the EVENT select proper repetition unit for the "Repeat" form field. Input field for the recurrence interval will appear left to the frequency select. According to the selected unit, FREQ property of the EVENT RRULE will be set to one of the: SECONDLY, MINUTELY, HOURLY, DAILY, WEEKLY, MONTHLY, YEARLY.

To specify end of the EVENT iterations, select "Series stop" value. For the "at date" option will be shown input for the date and time that will define UNTIL property of the EVENT RRULE.

"after" option, respectively, will put entered value to the COUNT property of the EVENT RRULE.

Form fields "By hour", "By week day", "By month", "By month day", "By set position", "By week number", "By year day", "By second" and "By minute" aren't shown by default. To enter value to any of these fields press according button on the left. Button with field name is grayed off when corresponding EVENT property is empty.

When gray button with field name is pressed, field input control appears on the right. In the same time button with field name becomes orange, indicating that field value will be saved for the EVENT. Fields with checkboxes controls have auxiliary button "Invert selection". When button "Invert selection" is pressed currently empty checkboxes become selected and currently selected checkboxes become empty.

When form data will be saved, checkboxes values will be saved as coma separated numbers. BYxxx RRULE properties expand or limit behavior of the FREQ according to the table in the [RRULE](#)

**specification.** Field "By week day" has two variants of the input: checkbox for each week day and text input.

Text input can be used, if "By week day" value is more complex than list of week days, separated by coma, for example for `FREQ MONTHLY` value `"2TH,-3FR"` in the "By week day" will mean second Thursday from the month start and third Friday from the month end in every month. Such value can't be presented as checkboxes selection.

Fields "By set position" and "By year day" are text inputs. Value format for these fields is set of the `[+/-INUMBER]` values, separated by comma.

For the "By year day" minus sign in front of year day number means that this day should be taken by number from the end of the year.

For the "By set position" minus sign in front of the position of the iteration means that the iteration should be taken by number from the end of the generated iterations sequence.

After new event created, event will appear in time set event list. It will have column with rule text description, buttons to request event edit form or event deletion.

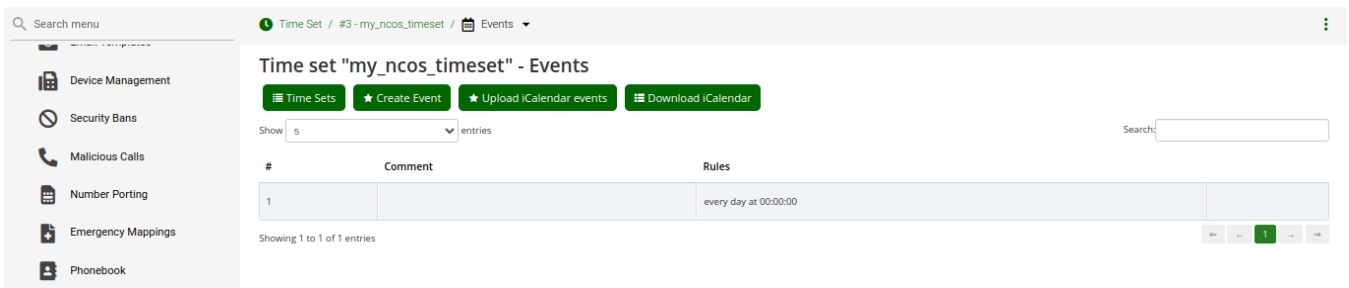

In events list section all events can be redefined uploading ics iCalendar file:

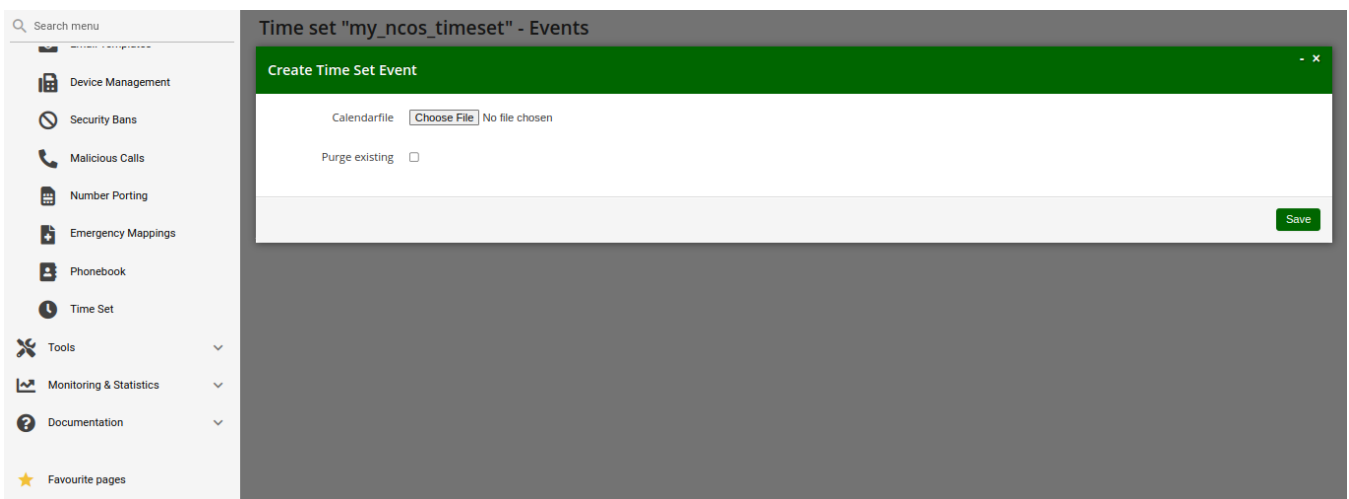

If "Purge existing" option is selected, all existing time set events will be removed before creation of the events from the uploaded file.

To download the iCalendar ics file of the time set, press "Download iCalendar".

### 7.37.4. Web interface for time set related to reseller

Reseller details page provides list of the time sets connected to the reseller and allows create, edit, delete and download time set and has link to the time set events section:

The top screenshot shows the 'Resellers' page. The left sidebar contains navigation options: Dashboard, Settings, Administrators, Resellers, Customers, Contracts, Contacts, and Domains. The main content area displays a table with columns: Id, Contract, Name, and Status. A single row is visible with Id '1', Contract '1', Name 'default', and Status 'Active'. A 'Details' dropdown menu is open for the first row, showing options: Edit, Journal, Preferences, and Terminate.

The bottom screenshot shows the 'Time Sets' page for a specific reseller. The left sidebar contains navigation options: Dashboard, Settings, Administrators, Resellers, and Customers. The main content area displays a table with columns: Id and Name. A single row is visible with Id '3' and Name 'my\_ncos\_timeset'. The page also shows a breadcrumb trail: Resellers / #1 - default / Details / Time Sets.

In difference to the main time set interface, iCalendar ics file for the time set can be downloaded from the time set list pressing "Download" button.

The creation form does not have the "Reseller" field and is processed in the context of the current selected reseller.

### 7.37.5. REST API

Time sets management is possible using REST API entry point `/api/timesets/`.

Time sets API has possibility to get and return information both as "application/json" data and as "text/calendar" file.

To create time set with events the full specification of the all fields in json format can be used:

```
curl --request POST --user administrator:administrator --header 'Prefer:
return=representation' --header 'Content-Type: application/json'
'https://127.0.0.1:1443/api/timesets/' --data '{"reseller_id":"3",
"name":"api_test_timeset_name1","times":[{"start":"1971-01-01
00:00:01","until":"1997-01-01 23:59:59","end":"2020-12-31 23:59:59"}]}'
```

Also time set and events can be uploaded as ics iCalendar file:

```
curl --request POST --user administrator:administrator --header 'Prefer:
return=representation' --header 'Content-Type: multipart/form-data'
'https://127.0.0.1:1443/api/timesets/' --form
'json={"reseller_id":3,"name":"unique_name"}' --form
'calendarfile=@/path/to/calendar.ics'
```

Output of the GET request to the time set item can be text/calendar:

```
curl --request GET --user administrator:administrator --header 'Accept:
text/calendar' 'https://127.0.0.1:1443/api/timesets/12' \>
/path/to/download/calendar.ics
```

or application/json:

```
curl --request GET --user administrator:administrator --header 'Accept:
application/json' 'https://127.0.0.1:1443/api/timesets/12'
```

By default the API will send response in text/calendar format.

Output will be generated iCalendar including time set events:

```
curl --request GET --user administrator:administrator
'https://127.0.0.1:1443/api/timesets/12'
BEGIN:VCALENDAR
PRODID:-//Mozilla.org/NONSGML Mozilla Calendar V1.1//EN
NAME:api_test_timeset_name2
VERSION:2.0

BEGIN:VEVENT
UID:sipwise19@sipwise15
SUMMARY:unique_name event 19
DTSTART:19710101T000001
DTEND:20201231T235959
END:VEVENT
END:VCALENDAR+
```

## 7.38. Announcement To Callee

This feature allows a caller to play a custom announcement to the callee every time they make a call. The announcement is played to the callee immediately after they answer the call (200OK is received by the Sipwise C5), therefore it can be used to provide some information about the caller. While the callee is listening to the announcement, the caller is still in the ringing status. The parties will be put in connection right after the announcement ends.

The configuration of the announcement is similar to the activation of [Pre-Recording Announcement](#) and it requires a few simple steps.

First create a system sound set for the feature. In *Settings Sound Sets* hover over the entry and press *Files*. Either use your already existing *Sound Set* or create a new *Sound Set* and then assign it to your domain or subscribers. In the *Sound Set* there is an announcement *early\_media announce\_to\_callee* for that purpose.

Once the *Sound Set* is created the caller subscriber's preference *play\_announce\_to\_callee* must be enabled under in the Subscriber's preferences. The same parameter can be set in the Domain's or Customer's preferences to enable this feature for all its subscribers.

**NOTE** | The announcement length is limited to 30 seconds.

**IMPORTANT** | Differently from the *Pre-Recording Announcement*, in all **Call Forward** cases with the *Announcement To Callee* feature enabled on both the caller and the forwarder, only the announcement of the forwarder will be played to the callee.

## 7.39. Header Manipulations

### 7.39.1. Overview

The Header Manipulations feature provides a flexible way to modify the headers of SIP messages when they are being processed by the SIP proxy. This helps with scenarios where based on specific header conditions, certain header changes must take place (e.g.: If "From" does not match expected number or format, and there is no Diversion header, then the P-Asserted-Identity header must be modified (or added) with the current subscriber's network provided CLI number). Another example is when there is a faulty User-Agent sending a malformed Contact entry then, based on the User-Agent header value and Contact header format, it becomes possible to detect such a scenario, and fix the Contact header on the fly without directly modifying the proxy logic.

**Header Manipulations** (also called in the UI/API as **Header Rules**) consist of:

- **Sets** - belong to a reseller, contain **Rules** and can be assigned to **Domains**, **Subscribers** and **Peer Hosts**.
- **Rules** - belong to **Sets** and contains **Conditions** and **Actions**
- **Conditions** - contain header expressions to be evaluated, if any **Condition** returns **False** then the whole **Rule** is immediately ignored.
- **Actions** - contain actions that are applied to the headers if all **Conditions** of the **Rule** are evaluated as **True**

### 7.39.2. Sets

Set is a topmost level entry and used in **Domain / Peer / Subscriber** based header manipulation scenarios. Only one Set can be assigned per **Domain / Peer / Subscriber** but the same Set can be assigned to any of them simultaneously.

- Reseller (for platform administrators): reseller\_id the Set belongs to
- Name: set name
- Description: custom description

### 7.39.3. Rules

A rule should have at least one Condition and Action to be taken into account. All Conditions of the Rule must match, otherwise the Rule is skipped.

- Name: rule name
- Description: custom description
- Priority: a number that defines the priority of the Rule. Smaller numbers have higher priority. All Rules within the same Set are evaluated by priority and as such, it is important to have them ordered as expected
- Direction: defines when the Rule is used

A-Leg Inbound: applied when a SIP message is received by the proxy from the load balancer, the Set to be applied is picked from the **caller** preferences

A-Leg Outbound: applied when a SIP message is about to leave the proxy to reach the B2BUA

(Sems), where the Set to be applied is picked from the **callee** preferences

Local: applied when a SIP message is going to be routed to a local subscriber, where Set to be applied is picked from the **caller** preferences

Peer: applied when a SIP message is going to be routed to a peering, where Set to be applied is picked from the **caller** preferences

B-Leg Outbound: applied when a SIP message is about to leave the proxy to reach the final destination, where the Set to be applied is picked from the **callee** preferences

Call Forward Inbound: applied when a SIP message is coming via the call forwarding, where Set to be applied is picked from the **caller** preferences

Call Forward Outbound: applied when a call forwarding is triggered, where Set to be applied is picked from the **callee** preferences

Reply: applied when a SIP reply message is received by the proxy, where Set to be applied is picked from the **caller** preferences

- Stopper: can be either **True** or **False**. When set to **True** and the Rule is successful then no further Rules are processed within the given Set
- Enabled: can be either **True** or **False** and defines whether to include the Rule into processing within the given Set

#### 7.39.4. Conditions

Condition contains one or more header validation expressions. Conditions do not modify any header data, they only evaluate it. Conditions also operate with internal proxy runtime variables (\$avp,\$xavp) and they can be used to compare for instance, a header value with an \$avp value (these are for expert use only).

- Match: what to evaluate
  - header: header value
  - preference: subscriber or peering preference
  - avp: \$avp variable
- Part: if the header (or \$avp) value is a SIP-URI then it is possible to pick which part of it should be taken for the evaluation:
  - full: the entire value
  - username: SIP username
  - domain: SIP domain
  - port: SIP port
- Name: header or \$avp name
- Expression: expression that is used to compare the extracted value
  - is: strict string comparison
  - contains: if the value contains the matching part
  - matches: same as contains but also accepts **\*** to be used as none to many characters and **?** as any single character
  - regex: a regular expression

- Not: if set to **True** then the Condition returns **True** if the evaluation fails
- Type: user value type
  - input: raw string
  - preference: preference name, in this case the value(s) is taken from the preference. If the preference contains more than one value then all of them are evaluated until first match
  - avp: \$avp name, in this case the value(s) is taken from the \$avp. If the \$avp contains more than one value then all of them are evaluated until first match
- Value: one or many values, **NOTE:** supports inline \$avp transformations, e.g: if **\$avp(s:source\_cli) = 456** then **123\$avp(s:source\_cli)789** is evaluated as **123456789**
- Enabled: skipped if set to **False**
- Rewrite Rule Set: if the header value needs to be normalised before evaluation then an existing Rewrite Rule Set can be used for that, it is mandatory to select a header rules part when the option is used
- Rewrite Rule: Rewrite Rules to use from the selected Rewrite Rule Set
  - Inbound for Caller
  - Inbound for Callee
  - Outbound for Caller
  - Outbound for Callee

### 7.39.5. Actions

Action contains one or more changes that are applied to the headers if the Rule is successful, it is also possible to modify the internal proxy \$avp runtime values (expert use only). Unlike Conditions, all Actions are applied regardless if some cannot be applied (e.g.: a header to remove does not exist).

- Priority: a number that defines the priority of the Action. Smaller numbers have a higher priority. The order is important when for instance, you copy data between headers or need to add a header that does not exist yet
- Header: header or \$avp name to apply actions to
- Header Part: if the header (or \$avp) value is a SIP-URI then it is possible to pick which part of the value needs to be changed
  - full: the entire value
  - username: SIP username
  - domain: SIP domain
  - port: SIP port
- Type: type of action
  - add: add a new header. If the header already exists the action is skipped
  - set: replace value of an existing header. If the header does not exist the action is skipped
  - remove: remove an existing header
  - header: copy a value (or a part) from an existing header to this header
  - preference: copy a value (or a part) from an existing preference to this header

rsub: apply regex substring to the current header. format: **match;replace** (e.g: value=**1234567**  
rsub=**^12([0-9]45)67\$;\$1 result=345**)

- Value Part: if the value is a SIP-URI then it is possible to pick which part of the value should be used
  - full: the entire value
  - username: SIP username
  - domain: SIP domain
  - port: SIP port
- Value: value to apply or a header name if Type=header, or a preference name if Type=preference.  
**NOTE:** support inline \$avp transformations, e.g: if **\$avp(s:source\_cli)=456** then **123\$avp(s:source\_cli)789** is evaluated as **123456789**
- Rewrite Rule Set: if the header value needs to be normalised after evaluation then an existing Rewrite Rule Set can be used for that, it is mandatory to select a header rules part when the option is used
- Rewrite Rule: Rewrite Rules to use from the selected Rewrite Rule Set
  - Inbound for Caller
  - Inbound for Callee
  - Outbound for Caller
  - Outbound for Callee

### 7.39.6. Special Headers

There are special header names, they can be use in conditions and set in actions. The names are case insensitive.

- @Request-URI: retrieve or modify RURI of the SIP message
- @Reply-Status: retrieve or modify the reply status (e.g: 486). Can only be used in the reply direction.  
**NOTE::** reply status 1xx and 2xx cannot be changed as well as cannot be set
- @Reply-Reason: retrieve or modify the reply reason (e.g: Request Terminated). Can only be used in the reply direction

### 7.39.7. Usage

To start using Header Manipulations, a Set needs to be created. After this, one or more Rules should be created with a Direction depending on when you need to modify the headers. If there are headers to adjust before any proxy logic processing takes place, then the Direction **inbound** should be used. If there are headers to adjust right before the SIP message leaves the proxy, then the Direction **outbound** should be used. Once you created a Rule it is time to add at least one Condition and one Action, otherwise the Rule is skipped. Condition is an expression that you use to check if one or more headers of the SIP message (or an \$avp in expert cases) exist, and their values match the expression. Otherwise the Rule is skipped and next one with the same Direction and by Priority is evaluated. If all Conditions of the Rule are evaluated as **True**, then all Actions of the Rule are applied. If the Stopper flag is 'True' then the processing ends, otherwise the next Rule in line is evaluated.

Set can be assigned to a domain in the **Domain preferences** and is automatically inherited by all subscribers of the domain. It can be also applied to the **Peering preferences**. It is possible to override the Set per subscriber in the **Subscriber preferences**.

It is also possible to have **Subscriber only Rules**, they are created in the admin UI via the *Subscriber DetailsHeader Manipulations* and in the API they are created via `/api/headerrulesets`. Internally it is a Set but with a defined subscriber\_id. It is only possible to have one Set like this per subscriber. It is automatically created when used from the admin UI and you only work on the Rules level. This is useful when there is something specific that needs to be modified in the headers for particular subscriber(s). When Rules are applied in the logic the Domain/Subscriber Set is applied first and then per subscriber defined Rules if defined.

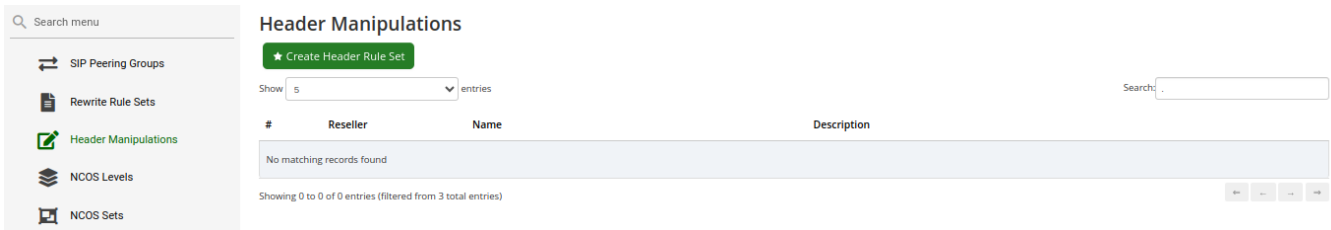

Figure 116. Header Manipulations

## 7.39.8. Usage Examples

### Inbound Call Add Diversion header

Goal: if **From** username starts with 43, add **Diversion** header if it does not exist and skip if already exists

```

Rule:
  Name: add_diversion
  Description: Add Diversion
  Priority: 1
  Direction: a_inbound
  Stopper: 0
  Enabled: 1

Conditions:
  -
    Match: header
    Part: username
    Name: From
    Expression: matches
    Not: 0
    Type: input
    Values:
      43*
    Enabled: 1
    Rewrite Rule Set:
    Rewrite Rule:

Actions:
  -
    Priority: 1
    Header: Diversion
    Header Part: full
  
```

```
Type: add
Value Part: full
Value: sip:431001@sipwise.com
Rewrite Rule Set:
Rewrite Rule:
```

### Outbound Add or Replace X-Test header

Goal: if **From** username equals to subscriber preference **cli**, add **X-Test** header if it does not exist or replace it if exists

```
Rule:
Name: add_replace_x_test
Description: Add or Replace X-Test
Priority: 1
Direction: b_outbound
Stopper: 0
Enabled: 1

Conditions:
-
  Match: header
  Part: username
  Name: From
  Expression: is
  Not: 0
  Type: preference
  Values:
    cli
  Enabled: 1
  Rewrite Rule Set:
  Rewrite Rule:

Actions:
-
  Priority: 1
  Header: X-Test
  Header Part: full
  Type: add
  Value Part: full
  Value: sip:430001@sipwise.com
  Rewrite Rule Set:
  Rewrite Rule:
-
  Priority: 2
  Header: X-Test
  Header Part: full
  Type: set
  Value Part: full
  Value: sip:430001@sipwise.com
  Rewrite Rule Set:
```

## Rewrite Rule:

**Remove P-Asserted-Identity, Replace Diversion, Add X-Test**

Goal: if a call is terminated to a local subscriber and **P-Asserted-Identity** exists, and its domain part contains sipwise.com or sipwise.local, Replace Diversion with the value from P-Asserted-Identity, remove P-Asserted-Identity and add X-Test with a value from the **cli** preference

## Rule:

```
Name: local_pai_diversion_x_test
Description: Local remove PAI, replace Diversion, add X-Test
Priority: 1
Direction: local
Stopper: 0
Enabled: 1
```

## Conditions:

```
-
  Match: header
  Part: domain
  Name: P-Asserted-Identity
  Expression: contains
  Not: 0
  Type: input
  Values:
    sipwise.com
    sipwise.local
  Enabled: 1
  Rewrite Rule Set:
  Rewrite Rule:
```

## Actions:

```
-
  Priority: 1
  Header: Diversion
  Header Part: full
  Type: header
  Value Part: full
  Value: P-Asserted-Identity
  Rewrite Rule Set:
  Rewrite Rule:
-
  Priority: 2
  Header: P-Asserted-Identity
  Header Part: full
  Type: remove
  Value Part: full
  Value:
  Rewrite Rule Set:
  Rewrite Rule:
-
```

```
Priority: 3
Header: X-Test
Header Part: full
Type: preference
Value Part: full
Value: cli
Rewrite Rule Set:
Rewrite Rule:
```

## Reject an incoming call

Goal: if P-Asserted-Identity username is equal to '112' emergency number, the call has to be rejected with code '456'.

```
Rule:
Name: reject_pai_112
Description: Reject if PAI equals to 112
Priority: 1
Direction: a_inbound
Stopper: 1
Enabled: 1

Conditions:
-
  Match: header
  Part: username
  Name: P-Asserted-Identity
  Expression: is
  Not: 0
  Type: input
  Values:
    112
  Enabled: 1
  Rewrite Rule Set:
  Rewrite Rule:

Actions:
-
  Priority: 1
  Header: $avp(s:hm_reject)
  Header Part: full
  Type: set
  Value Part: full
  Value: 456
  Rewrite Rule Set:
  Rewrite Rule:
```

## 7.40. Phonebook

### 7.40.1. Overview

Phonebook enables on the NGCP platform a configurable list of entries (namenumber) per Reseller, Customer or Subscriber that are provisioned on the subscribers' devices (phones) and presented there as an external phonebook.

### 7.40.2. Inheritance

- Entries that are defined on Reseller level are automatically included into the subscriber's phonebook unless overridden on Customer or Subscriber levels.
- Entries that are defined on Customer level override matching entries from Reseller level and automatically included into the subscriber's phonebook unless overridden on Subscriber level.
- Entries that are defined on Subscriber level override matching entries from Reseller and Customer levels and automatically included into the subscriber's phonebook.

Overrides uses the number field for matching.

### 7.40.3. Reseller Phonebook

To manage Reseller Phonebook you must be an admin user, there is a Phonebook entry in Settings dropdown list.

**Create Phonebook**
✕

Reseller Search:

#	Name	Contract #	Status	
1	default	1	active	<input type="checkbox"/>

Showing 1 to 1 of 1 entries

Name

Number

Figure 117. Create Reseller Phonebook Entry

- Name: Enter a name for the entry (e.g.: Emergency Number or Alice)

- Number: E164 number. The format is free but E164 is preferred so that the entries can be overridden when needed on Customer or Subscriber levels.

#### 7.40.4. Customer Phonebook

Customer Phonebook is located as one of the available Customer detail entries.

Phonebook

★ Create Phonebook Entry   ★ Download CSV   ★ Upload CSV

Show 5 entries   Search:

#	Name	Number
1	Alice	4310001

Showing 1 to 1 of 1 entries

Figure 118. Customer Phonebook Entries

In the given example there is Alice number defined in the phonebook, so it is shared across all subscribers of the customer, plus numbers from Reseller Phonebook.

#### 7.40.5. Subscriber Phonebook

Subscriber Phonebook is located as one of the available Subscriber detail entries.

Phonebook

★ Create Phonebook Entry   ★ Download CSV   ★ Upload CSV

Show 5 entries   Search:

#	Name	Number	Shared
1	Bob	4310002	0
3	Carol	4310003	1

Showing 1 to 2 of 2 entries

Figure 119. Subscriber Phonebook Entries

In the given example there is Bob and Carol numbers defined in the phonebook.

There is a new field on Subscriber level, 'Shared', it defines whether the number is private to the subscriber, if 'Shared=0', or shared across other subscribers of the same customer if 'Shared=1'.

Therefore, Bob is private to the subscriber and Carol entry is shared.

#### 7.40.6. Using CSV Upload and Download

Clicking 'Download CSV' automatically downloads all entries of the level into a csv file. The downloaded entries are exactly ones in the phonebook and inheritance is not used in this case.

Clicking 'Upload CSV' opens a dialog.

- Upload phonebook: choose a local .csv file with expected fields "Name", 'Number', and 'Shared' if uploaded into Subscriber level. It is a good practice to quote name to resolve situations with spaces. Commas must be escaped with \.

```
phonebook_upload.csv
"Shaw\, Alice",4310001
```

```
phonebook_upload_subscriber.csv
"Shaw\, Alice",4310001,0
"Bob",4310002,1
```

- Purge existing: if checked, deletes all existing entries before uploading new ones, otherwise the entries are merged by the Number field, where new entries override old entries on match.

### 7.40.7. Manually enabling Phonebook in a PBX device

Currently supported devices:

- Cisco SPA
- Panasonic
- Yealink
  1. In your provisioned PBX device, fetch its MAC address.
  2. Open Directory/Remote Phonebook and enter one of the supported URLs depending on the device model:
- Cisco SPA: [https://\\$host:\\$port:/pbx/directory/spa/\\$mac](https://$host:$port:/pbx/directory/spa/$mac)
- Panasonic: [https://\\$host:\\$port:/pbx/directory/panasonic/userid=\\$mac](https://$host:$port:/pbx/directory/panasonic/userid=$mac)
- Yealink: [https://\\$host:\\$port:/pbx/directory/yealink/userid=\\$mac](https://$host:$port:/pbx/directory/yealink/userid=$mac)

Where host is the NGCP host and port is the API configured port.

Figure 120. Phonebook Device Provisioning

### 7.40.8. Using Phonebook data for external display name lookup

Phonebook data, stored inside NGCP internal database, can be used to force a different display name for *FROM* and *P-ASSERTED-IDENTITY* if the caller is an external entity (call from PSTN or from different PBX if pbx module is active). To enable this feature just set the value "proxy.phonebook\_lookup.enable" to "yes" in config.yml, additionally, configure the following fields inside "proxy.phonebook" node:

- `enable`: `yes` Enable the phonebook lookup
- `mode`: `"local"` It sets the type of the lookup to 'local'. Meaning the phonebook lookup is done over our local phonebook database;
- `put_result_in`: `"from-pai"` It changes both "From" and "P-Asserted-Identity" display name with the result of the lookup (if successful). Set this to "from" to change only "From" display name, or to "pai" to change only "P-Asserted-Identity" display name.

The query will be always performed according to the callee phonebook data.

Phonebook lookup can be alternatively performed using an external HTTP rest API server. In this situation the user has to provide inside the `config.yml`, some additional information about how to reach the HTTP server. To activate this feature just change the `"proxy.phonebook_lookup.mode"` field from `"local"` to `"api"`, then fill the following fields:

- `mode`: `"api"` It sets the lookup via REST API.
- `api_url`: `string` Put here the Application Server endpoint URI.
- `api_hdrs`: `string` Set here the headers to use in the HTTP request, it can be useful for sending AUTH TOKENS.
- `api_result_field`: `string` The HTTP response must return valid JSON data, this parameter will instruct the proxy which JSON field to get the display name from.
- `api_caller_param_names`: This node is reserved for setting the search parameters when issuing the HTTP get.

List of search parameters names:

- `caller_number`: name of the API parameter on the remote server that NGCP should use to query the caller number (mandatory)
- `customer_id`: name of the API parameter on the remote server that NGCP should use to query the callee customer id
- `external_id`: name of the API parameter on the remote server that NGCP should used to query the callee external id (see preference `ext_subscriber_id`)
- `reseller_id`: name of the API parameter on the remote server that NGCP should used to query the callee reseller id
- `subscriber_id`: name of the API parameter on the remote server that NGCP should used to query the callee subscriber id

`caller_number` is the only required field , cause the scope is to lookup the display name associated to the caller number. All other fields can be added as API parameters, depending on customer need, but in general they are optional. If one or more parameters are not required, their value can be removed from the `config.yml` or set to empty string.

#### WARNING

Phonebook lookup API method causes the Proxy to issue a HTTP request and to wait up to 250 milliseconds to get the result. In case of network slowdown it can affect the proxy performance dramatically.

## 7.41. Subscriber Location Mappings

### 7.41.1. Overview

Subscriber Location Mappings enables incoming calls on a subscriber to also be routed and handled on additional "locations".

A location can represent:

- A SIP-URI of an NGCP subscriber, which may have one or more endpoints registered to it.
- Remote peering destinations.

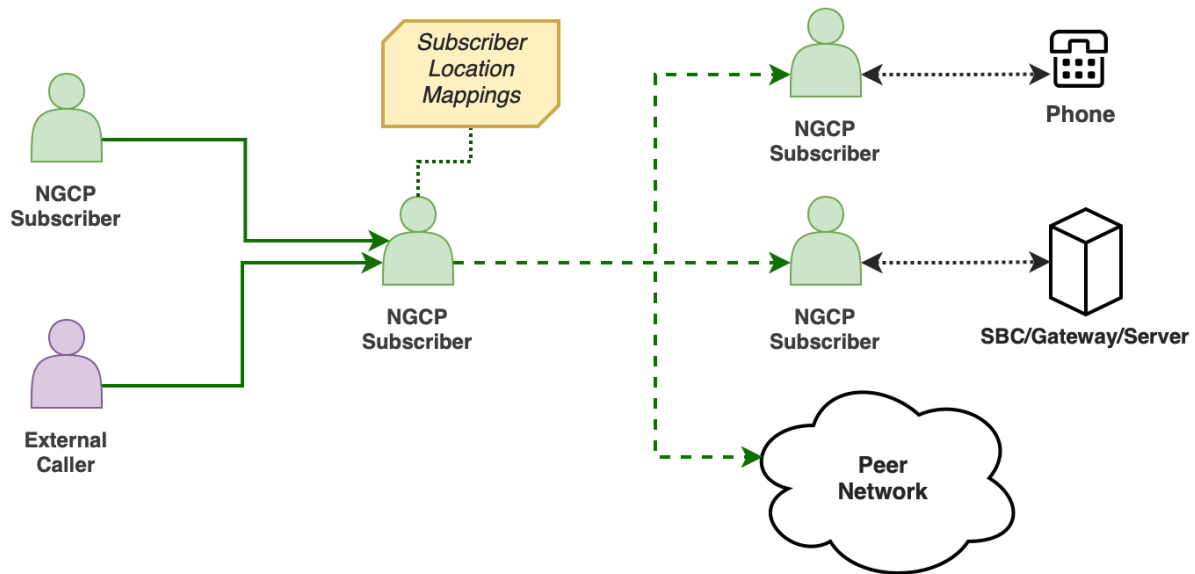

Figure 121. Subscriber Location Mappings - Overall View.

The feature can be set within subscriber preferences, via the Admin Panel or REST API.

Its main advantages are as follows:

#### (a) Definition of Several Call Branches.

By defining one or more location entries for a subscriber, it is possible to generate separate call branches for each destination, when an incoming call is received for that subscriber.

#### (b) Set Triggering Conditions and Mode for Each Call Branch.

In order to trigger a call branch, conditions can be defined for both caller and callee numbers via regular expressions, as well as the definition of the call branch behavior to be applied.

#### (c) Number Manipulations.

Number manipulations can be applied on the *username* part of the *Request-URI* (RURI) or the **To** field in a SIP INVITE message.

### Example Scenarios

There may be different scenarios in which the feature can be considered. Some examples, are:

Table 23. Scenario Examples.

Scenario	Description
NGCP Subscriber	<ul style="list-style-type: none"> <li>• Incoming calls on an NGCP subscriber are (also) delivered to another NGCP subscriber.</li> <li>• Two cases are possible: re-routed or multiplied calls.</li> </ul>
External Gateway	<ul style="list-style-type: none"> <li>• There is a Session Border Controller (SBC) with a registration in NGCP that is intended to receive calls for NGCP subscribers.</li> <li>• Incoming calls on an NGCP subscriber are also routed to the SBC.</li> <li>• The SBC may route the calls to other PBX.</li> </ul>
Remote Peer	<ul style="list-style-type: none"> <li>• Incoming calls on an NGCP subscriber are (also) delivered to a remote peer according to the outbound peering logic in place.</li> <li>• The remote peer will receive the call with source equals to the original caller.</li> </ul>

The following sections will provide more details about the feature.

### 7.41.2. Fields

Location mappings fields are summarized in the following table.

Table 24. Location Mapping Fields.

Field	Description
<i>Location SIP-URI</i>	<p>This field has two possible value options:</p> <ul style="list-style-type: none"> <li>• A SIP-URI of an NGCP subscriber (i.e. <i>sip:user@domain</i>). Mandatory value for the <b>Add</b>, <b>Replace</b> and <b>Offline</b> modes. See "Mode" below. <i>NOTE: This entry does not refer to a SIP-URI with location binding address.</i></li> <li>• A fictitious or an empty name for the <b>Forward</b> mode (The value is ignored during the branch creation). See "Mode" below.</li> </ul>
<i>Caller Pattern</i>	A regular expression pattern to match the <b>From</b> field of the INVITE (After Inbound Rewrite Rules). If left empty, it defaults to the <b>.+</b> pattern.
<i>Callee Pattern</i>	A regular expression pattern to match the <b>R-URI/To</b> of the INVITE (After Inbound Rewrite Rules). If left empty, it defaults to the <b>.+</b> pattern.

Field	Description
<i>Mode</i>	Defines the behavior of the matched entry during the call termination:
	<p><b>Add</b></p> <p>It appends the entry into the destinations list.</p> <ul style="list-style-type: none"> <li>The defined <i>Location SIP-URI</i> must have registered endpoints.</li> <li>Multiple <b>Add</b> entries matched are added into the call branching process.</li> </ul>
	<p><b>Replace</b></p> <p>It replaces the subscriber' SIP-URI as destination by this entry.</p> <ul style="list-style-type: none"> <li>The defined <i>Location SIP-URI</i> must have registered endpoints.</li> </ul>
	<p><b>Offline</b></p> <p>It appends the entry into the destinations list ONLY if the subscriber is offline (i.e. there are no registration records for the subscriber).</p>
	<p><b>Forward</b></p> <p>It appends the entry into the destinations list for a remote peer.</p> <ul style="list-style-type: none"> <li>If this mode is set, is not possible to call to another local subscriber.</li> </ul>
	" <i>Mode</i> " field is mandatory.
<i>RURI/To Username</i>	Replaces the <i>username</i> part of the <b>RURI/To</b> in a SIP INVITE with the value defined on this field. Useful for cases when the remote username is different than the one used for the location mapping.
External ID	An arbitrary string name (e.g. an identifier of a 3rd party provisioning/billing system). This is an optional attribute, which can be kept as empty.
<i>Enabled</i>	Enable/Disable the entry.

### About The 'Forward' Mode

The location mappings "*Forward*" mode works differently when compared to the others:

- This mode does not require the *Location SIP-URI* field, since it applies outbound peering logic to select the correct peer and automatically calculates the final destination.
- It creates a new parallel branch meant for peers only and it will behave like a Call Forward Unconditional (CFU). (NOTE: If you need to generate an internal call to local subscribers, use the **Add** mode instead.)
- The remote peer will receive the original caller as the source of the call (NOTE: User Provided Redirecting Number is intentionally disabled for this particular mode). Also, two different Call Detail Records (CDR) will be created: the first one from 'A' to 'B' (in which the CDR **call\_type** field equals to 'call'), and the second one from the original callee subscriber to the peer (with **call\_type** = 'cfu').
- To prevent the call to be looped back, the new parallel branch is terminated, if the inbound peer belongs to the same peer group of the outbound peer. However, it is possible to disable this check by activating the **allow\_lm\_forward\_loop** peer preference ("*Internals*" section) of the outgoing

peer.

### 7.41.3. Provisioning via Admin Panel

Subscriber Location Mappings can be accessed at *Subscriber Preferences Location Mappings* section. The interface will offer the option to create a new entry, or edit any of the existing ones.



Figure 122. Location Mappings Section.

Press the ADD button.

As shown in the example below, data can be entered and saved to create the new entry.

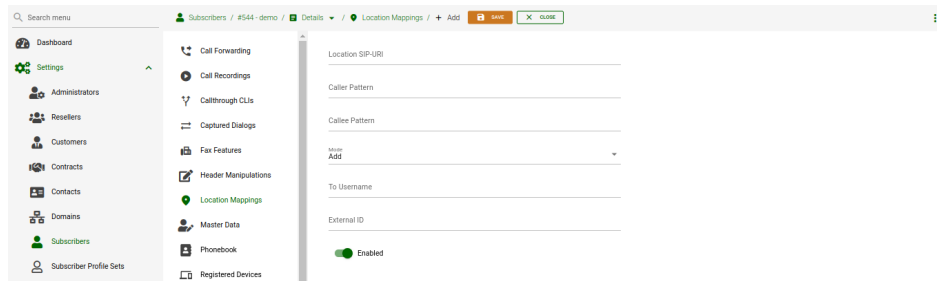

Figure 123. Subscriber Location Mappings: Create Entry.

Parameters are the ones described on the "Fields" section.

#### Practical Example

Let us assume that an administrator will use the Admin Panel to provision some location mappings on a selected subscriber. The following *Subscriber Details* are considered:

Table 25. Practical Example - Subscriber Details.

Field	Value
SIP URI	sip:su1@siphomelab.com
Primary Number	4312521523
Alias Numbers	4312521523001 4312521523002

Then, on *Subscriber Preferences*, within the *Location Mappings* section, the following entries are defined:

Id	Location SIP-URI	Caller Pattern	Callee Pattern	Mode	To Username	External ID	Enabled
3	sip:su3@siphomelab.com	.*	*4312521523\$	add	+	bs-29jdas2s2	<input checked="" type="checkbox"/>
5	sip:su3@siphomelab.com	.*	*4312521523001\$	replace	99001	bs-67235v76fe	<input checked="" type="checkbox"/>
7	sip:su3@siphomelab.com	.*	*4312521523002\$	offline	99002	bs-54fa5hzoeg	<input checked="" type="checkbox"/>
9	sip:gw-mirror@siphomelab.com	.*	.*	add	+	ext-ikywx523vd	<input checked="" type="checkbox"/>

Figure 124. Practical Example - Subscriber Location Mappings.

In the provided example, the logic is as following:

Table 26. Practical Example - Logic &amp; Result.

Logic	Result
<ul style="list-style-type: none"> <li>An incoming call to the subscriber number <b>4312521523</b> will be additionally sent to the devices registered with <b>sip:su3@siphomelab.com</b>.</li> </ul>	<ul style="list-style-type: none"> <li>The call will ring on the registered devices of <b>sip:su1@siphomelab.com</b>.</li> <li>The call will ring on the registered devices of <b>sip:su3@siphomelab.com</b>.</li> <li>The call will ring on the registered devices of <b>sip:gw-mirror@siphomelab.com</b>.</li> <li>When a device takes the call, the call will be cancelled on the rest of devices.</li> </ul>
<ul style="list-style-type: none"> <li>An incoming call to the subscriber number <b>4312521523001</b> will replace the current subscriber SIP-URI as destination (i.e. the call will not be terminated at the devices registered with <b>sip:su1@siphomelab.com</b>).</li> <li>Instead, the call will be sent to the registered devices with location entry <b>sip:su3@siphomelab.com</b> with the "username" part of the INVITE replaced with number <b>990001</b>.</li> </ul>	<ul style="list-style-type: none"> <li>The call will NOT ring on the registered devices of <b>sip:su1@siphomelab.com</b>.</li> <li>The call will ring on the registered devices of <b>sip:su3@siphomelab.com</b> with the number <b>990001</b>.</li> <li>The call will ring on the registered devices of <b>sip:gw-mirror@siphomelab.com</b>.</li> <li>When a device takes the call, the call will be cancelled on the rest of devices.</li> </ul>
<ul style="list-style-type: none"> <li>An incoming call to the subscriber number <b>4312521523002</b> will be additionally sent to the devices registered with <b>sip:su3@siphomelab.com</b> only if there are NO active registrations under this subscriber (i.e. <b>sip:su1@siphomelab.com</b> is offline).</li> <li>Also, the "username" part of the INVITE will be replaced with number <b>990002</b>.</li> </ul>	<ul style="list-style-type: none"> <li>If <b>sip:su1@siphomelab.com</b> is offline, then the call will ring on the registered devices of <b>sip:su3@siphomelab.com</b> with the number <b>990002</b>.</li> <li>The call will ring on the registered devices of <b>sip:gw-mirror@siphomelab.com</b>.</li> <li>When a device takes the call, the call will be cancelled on the rest of devices.</li> </ul>

Logic	Result
<ul style="list-style-type: none"><li>Any incoming call to the subscriber <i>sip:su1@siphomelab.com</i> will be additionally sent to the devices registered with <i>sip:gw-mirror@siphomelab.com</i>.</li></ul>	<ul style="list-style-type: none"><li>When a device takes the call, the call will be cancelled on the rest of devices.</li></ul>

## 7.42. STIR/SHAKEN

### 7.42.1. Overview

#### What does STIR/SHAKEN stand for?

STIR - Secure Telephony Identity Revisited (RFC8224, RFC8225 and RFC8226)

SHAKEN - Secure Handling of Asserted Information using tokens (RFC8588)

This technology gives an opportunity to make sure that the calling side (caller's number) is not spoofed, hence can help during the common work/inter-cooperation between ITSPs, for call spoofing detection. When it is used by ITSPs, it decreases the amount of robo-calls.

#### NOTE

ITSP - Internet Telephony Service Provider. Is a general abbreviation for VoIP service providers, which can use IP-based technologies/protocols such as SIP protocol or H.323 stack of protocols to provide telephony services.

The Sipwise C5 is currently compliant with the list of general RFC standards:

- RFC8224 - Authenticated Identity Management in the Session Initiation Protocol (SIP) (this RFC obsoletes RFC 4474) ;
- RFC8588 - Personal Assertion Token (PaSSporT) Extension for signature-based handling of Asserted information using toKENs (SHAKEN) ;

#### Why do you need STIR/SHAKEN?

As the VoIP world grows new security mechanisms come into play, which can provide protection on different layers of VoIP. STIR/SHAKEN is one of these mechanisms and it works as a superstructure over the VoIP system. It can be considered as the Application layer of TCP/IP stack (in common with SIP).

This standard has been developed by IETF, to provide a new way to detect spoofed calls and to help ITSPs to protect their customers. This means a decrease in the amount of fraudulent events/bot calls. A notable strength of this technology is that it not only works within the scope of your VoIP system, but it is also dependent on other intermediary/termination ITSPs. Therefore it can bring a good quality improvement for a protection from undesired calls (bot-calling).

#### NOTE

The SIP header declared for this purpose is called literally "Identity:".

#### IMPORTANT

The "Identity-Info:" header is deprecated by RFC 8224 and now is stored as the ";info=" parameter within the "Identity:" header.

### 7.42.2. Operation of STIR/SHAKEN

All logical parts of STIR/SHAKEN fall into these sub-categories:

- Originating service provider - a system which performs an authentication (IP based, digest over MD5 etc.) of the calling party (SIP). It has to support all the needed RFC regulations to add/manipulate the Identity header. This entity does all the work to prepare the "Identity" header before sending a call out ;
- Terminating service provider - a remote VoIP system (call termination ITSP), which verifies if the call

is compliant with the STIR/SHAKEN technology, then verifies it before to accept and send to the edge subscriber. As well as with the Originating service provider, it has to support all the needed functionality to manipulate the Identity header. This entity does all the work on the Identity header of the received request, such as: decryption of the JWT token stored inside the "Identity" header and an attestation level verification ;

- Authentication service - is a superstructure/standalone authority used by the originating ITSP to obtain certificates/keys needed to encrypt the "Identity" header's value (JWT token). It is only used for work with certificates and keys ;
- Verification service - is a superstructure/standalone authority used by a terminating ITSP to obtain certificates/keys needed to decrypt the "Identity" header's value (JWT token). The same as with the Authentication service, it's only used for work with certificates and keys ;

The Sipwise C5 system role will be:

- Originating service provider - when Sipwise C5 sends a call out to PSTN networks
- Terminating service provider - when Sipwise C5 is a recipient of the call coming from PSTN networks

#### NOTE

This technology assumes that there is some centralized authority or a list of them, which will be used both by the originating and the terminating service providers.

#### How STIR/SHAKEN works

- Firstly, a SIP call is originated and obtained by a specific ITSP (let us refer to it as ITSP A);
- ITSP A verifies the call source and its number, in order to define how to confirm validity (full, partial or gateway attestation);
- ITSP A creates a SIP Identity header that contains the information on the calling number, called number, attestation level and call origination, along with the certificate (important). All information in the Identity header gets encrypted into the JWT token, with the following list of parameters;
- The call (INVITE request) is sent out with the SIP Identity header (which has a reference to the certificate) to a certain destination ITSP (let us refer to it as ITSP B);
- ITSP B verifies the identity of the header and the certificate itself;
- ITSP B makes sure the attestation level is complaint with local security standards (A, B or C);
- ITSP B sends a call to the edge subscriber (with possibly added parameters to the PAI header - verstat);

Essentially this technology allows the destination user/service provider to verify that the original caller (calling side) is the one that it claims to be.

#### Possible attestation levels:

- Full attestation ( A ) - SP authenticates the calling party and confirms it is authorized to use this particular number. An example is SIP registration: we say that originating ITSP recognizes the entire phone number as being registered with the originating subscriber;
- Partial attestation ( B ) - SP verifies the call origin, but cannot fully confirm that the source of the call is authorized to use this number. An example is a calling party (number) from behind a remote PBX: you give a block of numbers to the customer and trust this customer entirely, but you cannot verify directly individuals that use those numbers;

- Gateway attestation ( C ) - SP authenticates the call's origin, but there is no way to verify the source. An example is a call received from an international gateway: you have a legal interconnection, but you don't know who is sitting behind and using source numbers, which you let to pass through your network;

**NOTE**

In most cases, the attestation level which will appear in calls involving Sipwise C5 - will be "A". Unless you do not use a subscriber preference "trusted source" and/or a domain preference "unauth\_inbound\_calls".

### 7.42.3. Identity header constitution

- a JSON Web token - JWT, that in addition consists of the following parts (divided by the dot symbol '.'):
  - header* - stores: an encryption algorithm, used extension (usually 'shaken'), token type (usually 'passport'), location of the cert used to sign the token
  - payload* - stores: an attestation level, calling/called number, a timestamp when token was created (epoch), an origination identifier (most likely UUID)
  - signature* - some encoded string (binary data) in Base64 URL

- three parameters (currently):

*;'info='* - is a substitution of the deprecated Identity-Info header (will usually have a reference to a public key, which will be used to decrypt then a signature encrypted previously with a private key)

*;'alg='* - specifies the use of a cryptographic algorithm for the signature part of the JWS (for e.g. 'ES256')

*;'ppt='* - can extend the payload of PASSporT with additional JWT claims (requires that a relying party supports a particular extended claim, for e.g. 'shaken')

**TIP**

Signature - is some encoded string (binary data) in Base64 URL, where its syntax is: *Base64URL( ES256 (Base64URL(JWT header).Base64URL(JWT payload)) )*. Firstly the Base64 URL is built, then also the signature with the private key is built, and a URL to the public key certificate corresponding to that key is added (as a value in the *;'info='* parameter).

**NOTE**

The Receiving party will have to download the certificate and perform a signature verification. In case the check passes, it will trust the value stored in the attestation level parameter. And of course the value of caller/callee ( "orig" / "dest") has to match the actual data (in SIP headers) to be sure it's not an attack and is not a call which reuses a value from another INVITE not related to the current one.

### 7.42.4. Implementation of STIR/SHAKEN in Sipwise C5

Currently the Sipwise C5 is using the Kamailio project's *Secsipid.so* module to provide all, or almost all required STIR/SHAKEN related features.

**NOTE**

The secsipid module relies on libsecsipid from the Secsipidx project. Link to the SecSIPIDx project at Github: <https://github.com/asipto/secsipidx>

Secsipid - is a first implementation of STIR/SHAKEN IETF extensions (RFC8224, RFC8588) for asserting caller identity in Kamailio. The module is being developed further, and is reliable enough to be included in the Sipwise C5.

The configuration of the STIR/SHAKEN is done with `/etc/ngcp-config/config.yml`, with the section: `kamailio.proxy.stir`. To see how it's being configured, please take a look at [kamailio \(Appendix "Configuration Overview" "config.yml Overview"\)](#).

Domain preferences:

- 'stir\_pub\_url' - Public key HTTP URL
- 'stir\_check' - Enable STIR Identity validation

A quick start with STIR/SHAKEN:

1. Please be sure to identify the appropriate authorities with whom you need to establish contact in order to obtain the required certificates and keys.
2. Your certificates should be prepared for work with a needed domain (your SIP domain), then you upload the given private key(s) to your Sipwise C5 system ;
3. Basically a general parameter (in the `config.yml`) you need to take care of is 'domains', and of course the given keys to it. The rest can be left untouched, unless you have some preferences for your domain(s) ;
4. Don't forget to define the related domain preferences (via the web panel) 'stir\_pub\_url' and 'stir\_check' to enable SHAKEN for your domain(s);
5. After you are done with the configuration part, you need to apply changes with: `ngcpcfg apply "added stir-shaken support"` ;

#### IMPORTANT

Applying the changes will imply a restart of the Proxy service, therefore it's strongly recommended to apply the changes outside of business hours.

#### IMPORTANT

Remember that the kamailio user needs read permissions on the private-key files, otherwise it will not be able to consume them.

#### NOTE

Keep in mind that you can have multiple domains and hence keys for them stored in the Sipwise C5. This depends on the amount of SIP domains you actually have, which use STIR/SHAKEN.

#### NOTE

The fact that you enabled support for STIR/SHAKEN on your platform, does not mean all of the present domains will have to use it. Checks/manipulations will be only enabled for those domains that are defined in `kamailio.proxy.stir.domains` of `/etc/ngcp-config/config.yml`

## Outbound calls and STIR/SHAKEN

At the moment the Sipwise C5 supports 'A' and 'B' attestation levels when sending outbound calls:

- 'A' - corresponds to a normally registered subscriber at the Sipwise C5 platform ;
- 'B' - will be set in case the subscriber uses the preference "trusted source" and/or is affected by the domain preference "unauth\_inbound\_calls" ;

## Inbound calls and STIR/SHAKEN

As soon as you enable STIR/SHAKEN for a certain domain served by the Sipwise C5 system, calls coming to this domain will be challenged according to RFC standards dedicated to processing of the Identity header.

For now the Sipwise C5 supports the following list of 4XX response codes:

- 428 - indicates an absence of the Identity header or wrong extension added into the ';ppt=' parameter ;
- 436 - indicates an inability to acquire the credentials needed by the verification service for validating the signature in an Identity header field ;
- 438 - indicates that no Identity header field with a valid and supported PASSporT object has been received ;

Normally, in case of an incoming call to a SIP domain with enabled STIR/SHAKEN, the "Identity" header's content will be decrypted, verified and the call will be sent further, according to the logic of the Sipwise C5 system setup.

## 7.43. Fileshare

### 7.43.1. Overview

Fileshare is a REST API endpoint, `/api/fileshare`, that provides NGCP users with a way to share data among other NGCP users or external users.

This feature is primarily used by the NGCP SIP::App and comes as a replacement for the ComX based fileshare component which is no longer supported by NGCP.

This feature can be provided to clients directly or integrated into own application services.

### 7.43.2. Example Scenarios

#### File Upload

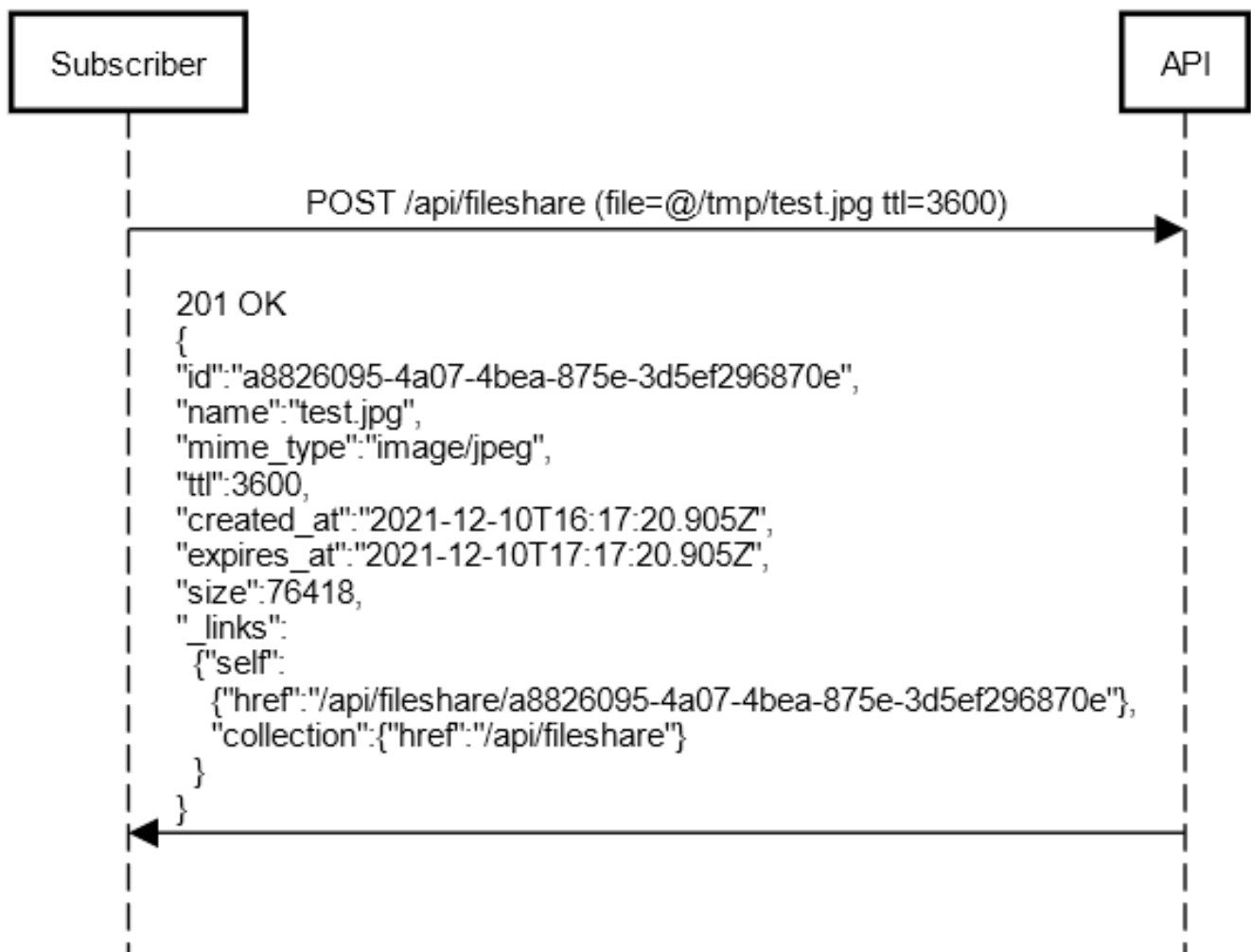

Figure 125. Fileshare File Upload

## File Download



Figure 126. Fileshare File Download

## Files Collection



Figure 127. Fileshare Uploaded Files

### 7.43.3. Configuration

Fileshare is disabled by default and requires basic configuration in the config.yml

```
config.yml

fileshare:
  enable: no
  limits:
    quota: 10737418240
    upload_size: 10485760
    user_files: 10
    user_quota: 20971520
  public_links: no
  ttl: 86400
```

- fileshare.enable: disabled by default, when enabled, rest\_api.enable is required to be on as /api/fileshare uses API v2.
- fileshare.limits.quota: allowed database quota threshold in bytes, when the table size reaches the quota threshold all subsequent file uploads are denied.
- fileshare.limits.upload\_size: single file upload size in bytes.
- fileshare.limits.user\_files: amount of uploaded files per user (subscriber).
- fileshare.limits.user\_quota: per subscriber uploaded files quota in bytes, calculated by the exact size of all uploaded files per user (subscriber)
- fileshare.public\_links: defines whether uploaded files can be downloaded by anybody without authentication (the exact URL must be provided to the end user).
- fileshare.ttl: uploaded file expiration time in seconds, default is 86400 (1 day) client, e.g: /api/fileshare/58f417bb-4d28-47cf-g673-0a9453b79cc5), access to the uploaded files collection via /api/fileshare always requires authentication.

### 7.43.4. Approach

#### File Upload

To upload a file the client must use POST and the file attached into the form named "file"

An example of file upload using 'curl':

```
curl -X POST -F 'file=@/tmp/sample_image.png' https://ngcp-  
api/api/fileshare
```

#### NOTE

One of the available authorization methods is required for the file upload (Basic Authentication or JWT)

There is an optional upload body parameter 'ttl', that can be provided to override the default ttl for the uploaded file.

An example of file upload with ttl using 'curl':

```
curl -X POST -F 'file=@/tmp/sample_image.png' -F ttl=3600 https://ngcp-api/api/fileshare
```

Once a file is successfully uploaded a JSON response is returned with the following data:

```
{
  "id": "b994894d-882b-4672-a152-ff1e68ab7ee0",
  "name": "sample_image.png",
  "mime_type": "image/png",
  "ttl": "3600",
  "created_at": "2021-12-14T20:58:13.483Z",
  "expires_at": "2021-12-14T21:58:13.483Z",
  "size": 198791,
  "_links": {
    "self": {
      "href": "/api/fileshare/b994894d-882b-4672-a152-ff1e68ab7ee0"
    },
    "collection": {
      "href": "/api/fileshare"
    }
  }
}
```

- The upload name is taken from the provided filename.
- The MIME type is automatically determined by the server.

## File Download

To download a file a full URL must be provided, e.g.:

```
curl -X GET https://ngcp-api/api/fileshare/b994894d-882b-4672-a152-ff1e68ab7ee0
```

If `fileshare.public_links` is enabled in the `config.yml`, then there is no authorization required for the link to work, otherwise an authorization is required for the link to be used (any authenticated NGCP subscriber (or admin) user can use the link).

The response is a data stream.

## Files Collection

As a subscriber (or an admin) you can retrieve all your uploaded files list as:

```
curl -X GET https://ngcp-api/api/fileshare/
```

The response is a JSON HAL collection.

```
{
  "_links": {
    "self": {
      "href": "/api/fileshare?page=1&rows=10"
    },
    "ngcp:fileshare": [
      {
        "href": "/api/fileshare/1ec51a35-92e7-46be-aa98-db69f11483a7"
      },
      {
        "href": "/api/fileshare/58f417bb-4d28-47cf-9673-0a9453b79cc5"
      }
    ],
    "collection": {
      "href": "/api/fileshare"
    }
  },
  "total_count": 2,
  "_embedded": {
    "ngcp:fileshare": [
      {
        "id": "1ec51a35-92e7-46be-aa98-db69f11483a7",
        "name": "doc.pdf",
        "mime_type": "application/pdf",
        "ttl": 86400,
        "created_at": "2021-12-11T11:46:39.000Z",
        "expires_at": "2021-12-12T11:46:39.000Z",
        "size": 10
      },
      {
        "id": "58f417bb-4d28-47cf-9673-0a9453b79cc5",
        "name": "sample_text.txt",
        "mime_type": "text/plain",
        "ttl": 3600,
        "created_at": "2021-12-14T18:17:15.000Z",
        "expires_at": "2021-12-14T19:17:15.000Z",
        "size": 10
      }
    ]
  }
}
```

**NOTE** It is also possible to receive the response in the OpenAPI format by providing an additional header, **Accept: application/json**

```
{
  "id": "1ec51a35-92e7-46be-aa98-db69f11483a7",
  "name": "doc.pdf",
  "mime_type": "application/pdf",
```

```
"ttl": 86400,  
"created_at": "2021-12-11T11:46:39.000Z",  
"expires_at": "2021-12-12T11:46:39.000Z",  
"size": 10  
},  
{  
  "id": "58f417bb-4d28-47cf-9673-0a9453b79cc5",  
  "name": "sample_text.txt",  
  "mime_type": "text/plain",  
  "ttl": 3600,  
  "created_at": "2021-12-14T18:17:15.000Z",  
  "expires_at": "2021-12-14T19:17:15.000Z",  
  "size": 10  
}
```

### File Removal

Files are removed automatically by the server based on their expiration time or manually per request.

```
curl -X DELETE https://ngcp-api/api/fileshare/b994894d-882b-4672-a152-  
ff1e68ab7ee0
```

## 7.44. Batch Provisioning

### 7.44.1. Overview

Batch provisioning of subscribers can ensure that all details of the required subscriber settings are correctly stored in the database. For the easy and convenient operation, NGCP provides the possibility to enter or upload the necessary, variable subscriber data and execute the provisioning automatically. This can be achieved through the administrative web interface, command line interface, or also via REST API.

The advantages are as follows:

#### (a) Standardizing complex subscriber setup procedures.

Batch provisioning allows to define provisioning templates, in which specific subscriber settings can be set. A template allows to define different types of input fields, parameters for internal calculations, and the setting of subscriber-related parameters.

#### (b) Scripting languages.

Provisioning templates allows the definition of code snippets for parameter calculations. Code can be based on JavaScript or Perl programming languages.

#### (c) Transactional processing (Rollback behavior).

Batch provisioning is based on transactional processing. If provisioning fails at a specific point, it will rollback what was created up to that point, in order to avoid residual data in the database.

#### (d) Processing speed.

Batch provisioning allows to process a large number of subscriber data with a considerable gain in processing speed.

The following sections will provide more details about these features.

### 7.44.2. Template Structure and Main Fields

Provisioning templates are commonly defined on the YAML language. The list of currently supported main keys are shown and described as follows.

*Currently supported main template fields.*

```
fields:
  #Structure that contains several input fields.
contract_contact:
  #Structure that contains several provisioning fields
  #for the contact of the customer.
contract:
  #Structure that contains several provisioning fields
  #for the customer.
contract_preferences:
  #Structure that contains several provisioning fields
```

```

#for customer preferences.
subscriber:
  #Structure that contains several provisioning fields
  #for subscriber details.
subscriber_preferences:
  #Structure that contains several provisioning fields
  #for subscriber preferences.
registrations:
  #Structure that contains several provisioning fields
  #for permanent registrations.
trusted_sources:
  #Structure that contains several provisioning fields
  #for trusted sources.
cf_mappings:
  #A structure that contains several provisioning fields
  #for call forward mappings.

```

### The 'fields' key

The fields key allows to define input hierarchical structures by providing additional key-value pair parameters. The supported attribute names are the ones defined in the Comprehensive Perl Archive Network (CPAN) `HTML::FormHandler::Field` Modules.

Parameters must contain a **name** and data **type**. For the latter, some basic type values are: *Integer*, *Float*, *Text*, *Boolean*, *Checkbox* and *Select*. Additional attributes can be appended as well.

The following example aims to show how to declare different parameters within the **fields** key. Let us assume that an administrator wants to:

- Declare a parameter named "my\_field1", which will be a mandatory input text labeled as "This is field 1 (Text)".
- Declare a parameter named "my\_field2", which will be an optional integer input labeled as "This is field 2 (Integer)".
- Declare a parameter named "my\_field3", which will be optional Boolean input labeled as "This is field 3 (Boolean)".
- Declare a parameter named "my\_field4", which will be a mandatory dropdown list labeled as "This is field 4 (Select)" with two sub-options labeled "optA-label", "optB-label" with the static values "optA-value", "optB-value", respectively.

The resulting YAML declaration will be:

*Example Form of Four Different Field Types.*

```

fields:
  - name: my_field1
    label: "This is Field 1 (Text)"
    type: Text
    required: 1
  - name: my_field2
    label: "This is Field 2 (Integer)"

```

```

type: Integer
- name: my_field3
  label: "This is Field 3 (Boolean)"
  type: Boolean
- name: my_field4
  label: "This is Field 4 (Select)"
  type: Select
  options:
    - label: optA-label
      value: optA-value
    - label: optB-label
      value: optB-value
  required: 1

```

The resulting web form will be shown as the picture below.

Figure 128. Resulting Form.

### The 'purge' attribute name

The **purge** attribute name is a reserved word that can be declared within the `fields` tag, as a *Boolean* type. When set to `1`, and if there is an existing subscriber with the same data to be provisioned (e.g. same username, number or alias), then the existing subscriber will be terminated before the new one is created. On the opposite, if set to `0`, that row will be skipped.

#### NOTE

The engine will not terminate anything other than a subscriber (Including its child items such as preferences, trusted sources, call forwards, etc.). Thus, the contract or contact is not terminated/deleted.

### The 'calculated' reserved parameter type

There is a special attribute type named `calculated`, which is not visible on form elements. It is declared for internal use to: (a) Store static values on attributes; (b) Store the output of computed operations coming from code snippets. As defined in `HTML::FormHandler`, the former requires declaring the `value` attribute name to store the data. The latter requires declaring the `value_code` attribute in order to store the data in the `value` attribute. Next sections will describe further details about this.

## Rest of Template Keys

The rest of the template keys can contain any of the NGCP settings, as detailed in the table below.

Table 27. Rest of Template Keys.

Field Name	Sub-fields
<code>contract_contact</code>	Available field names can be taken from the <code>/api/customercontacts/</code> API properties (Please, check API documentation), or from the fields belonging to the <code>billing.contacts</code> SQL table.
<code>contract</code>	Available field names can be taken from the <code>/api/customers/</code> API properties (Please, check API documentation), or from the fields belonging to the <code>billing.contracts</code> SQL table.
<code>contract_preferences</code>	Available field names can be taken from the <code>/api/customerpreferences/</code> API properties (Please, check API documentation).
<code>subscriber</code>	Available field names can be taken from the <code>/api/subscribers/</code> API properties (Please, check API documentation).
<code>subscriber_preferences</code>	Available field names can be taken from the <code>/api/subscriberpreferences/</code> API properties (Please, check API documentation).
<code>registrations</code>	Available field names can be taken from the <code>/api/subscriberregistrations/</code> API properties (Please, check API documentation).
<code>trusted_sources</code>	Available field names can be taken from the <code>/api/trustedsources/</code> API properties (Please, check API documentation).
<code>cf_mappings</code>	Available field names can be taken from the <code>/api/cfmappings/</code> API properties (Please, check API documentation).

### The 'identifier' sub-field and data lookup

The `identifier` field is a comma-separated list composed by one or more JSON/SQL properties. It can be specified within any of the template keys of the table above. It is a string list that the batch processing engine uses for data lookup in the database.

For instance, let us assume that the following declaration has been defined:

*Reference Example For The `identifier` Attribute.*

```
contract_contact:
  identifier: "firstname, lastname, status"
  reseller: default
  firstname_code: "function() { return row.first_name; }"
  lastname_code: "function() { return row.last_name; }"
  status: "active"
contract:
```

```

identifier: contact_id
contact_id_code: "function() { return contract_contact.id; }"
product: "Basic SIP Account"
billing_profile: "Default Billing Profile"

```

Firstly, a *Contract* refers to a customer (i.e. a PBX). When the engine processes a CSV file (or a Web form), it will search for a contract contact with the names specified in the **firstname** and **lastname** fields (e.g. "John, Doe"), and with the status field equals to "*active*".

If the contact entry does not yet exist, it will be created. At this stage, there are two situations:

(a) Contact does not yet exist: A new one is created, with some new **contact\_id** value.

(b) Contact already exists: It is looked up and returns some existing **contact\_id** value.

Regarding the **contract** tag, its identifier is the **contact\_id** field. Again, the engine will try to look up for a contract with the **contact\_id** previously obtained:

- When the contract contact was just created (Case (a) above), then there will neither be an existing contract. Hence, the contract is also created.
- In case (b), there is already a contact (e.g. "John Doe", which is active), then possibly also already a contract linked to it. Hence, the engine will not create another contract, but it looks up the existing one.
- Finally, the engine proceeds with creating subscribers and their corresponding settings.

Further sections will describe extra details on the template declaration.

### 7.44.3. Storing Data

When using internal attributes (i.e. defined by the calculated type), it is possible to store static data or code-calculated data (i.e. obtained from code snippets). Static data can be stored in any suitable attribute name according the template section in which will be declared. Notwithstanding, in order to store the output from a code snippet, that attribute name **MUST** be declared along with the **\_code** suffix concatenated to it. Some examples:

- Within the **fields** key, the **value** attribute name needs to be used to store static data. Hence, the **value\_code** attribute name must be declared in the template if a code snippet is put in place to calculate such data. When the data is computed, it will be stored in the **value** attribute.
- Within the **contract** key, **contact\_id** is one of the several available attributes for a customer that can be declared in that section. If the value of this attribute needs to be computed, then the **contact\_id\_code** attribute name needs to be declared, along with the corresponding code snippet. Then, when the data is computed, it will be stored in the **contact\_id** attribute.

### 7.44.4. Code Snippets

Code snippets allows to use programming logic to calculate attribute values. The supported programming languages are JavaScript and Perl.

The following directives must be declared to use code snippets in templates, for both JavaScript and Perl, respectively:

*Code Snippet Declaration: JavaScript and Perl.*

```
"function() {
  //JavaScript code logic
  ...
  return ... ; //Output to be stored in a *_code attribute name.
}"
```

```
"sub {
  #Perl code logic
  ...
  return ... ; #Output to be stored in a *_code attribute name.
}"
```

Native JavaScript/Perl directives can be used as part of the code logic, such as string concatenations, number stripping, etc. Furthermore, there are reserved variable names and special functions that can be used in a code. These are detailed in the following sections.

### Reserved Variable Names

Reserved variable names can be used in the definition of code snippets, summarized as follows.

*Table 28. Reserved Variable Names.*

Variable Name	Type	Description
<code>row</code>	<i>Class</i>	It represents the CSV file row (or the input form when filling out via Admin Panel) according the <code>fields</code> parameters defined in the template.
<code>contract_contact</code>	<i>Class</i>	Settings for the contact of the customer. It contains information such as the name, the postal and email addresses, among others.
<code>contract</code>	<i>Class</i>	Settings for customer. It refers to the <code>billing.contract</code> SQL table.
<code>contract_preferences</code>	<i>Class</i>	Settings for customer preferences.
<code>subscriber</code>	<i>Class</i>	Settings for subscriber details.
<code>subscriber_preferences</code>	<i>Class</i>	Settings for subscriber preferences.
<code>registrations</code>	<i>Class</i>	Settings for permanent registrations.
<code>trusted_sources</code>	<i>Class</i>	Settings for trusted sources.
<code>cf_mappings</code>	<i>Class</i>	Settings for call forward mappings.
<code>reseller</code>	<i>String</i>	Reseller name. The entity name that represents a collection of settings to provide telecommunication services to subscribers on the NGCP.
<code>billing_profile</code>	<i>String</i>	Billing profile name.

<code>profile_package</code>	<i>String</i>	Billing profile package name.
<code>domain</code>	<i>String</i>	SIP domain name. Particularly, it refers to the record for the <code>billing.domain</code> SQL table.
<code>provisioning_domain</code>	<i>String</i>	SIP domain name. Particularly, it refers to the <code>provisioning.voip_domain</code> SQL table.
<code>product</code>	<i>String</i>	The product type for the PBX customer. Either "Basic SIP Account" or "Cloud PBX Account".
<code>now</code>	<i>String</i>	It represents the transaction timestamp.

## Special Functions

Apart from using native JavaScript/Perl functions, there are special utility functions available, summarized as follows.

Table 29. Special Functions.

Function Name	Arguments	Description
<code>split_number()</code>	<i>String</i>	<p>It can split a number (entered as a text) into country code (<code>cc</code>), area code (<code>ac</code>) and subscriber number (<code>sn</code>). It MUST be used along with the definition of the <code>cc_ac_map</code> attribute name within the <code>fields</code> tag, as follows:</p> <pre>fields: - name: cc_ac_map   type: calculated   value:     - CC1:       - AC1:       - AC2:       ...     - CC2:       - AC1:       - AC2:       ...</pre> <p>Where:</p> <ul style="list-style-type: none"> <li>• <b>CC</b>: Country Code number (e.g. 43, 56, etc.)</li> <li>• <b>AC</b>: Area Code number (e.g. 1, 2142, etc.)</li> </ul>
<code>debug()</code>	<i>String</i>	<p>It prints 'debug' log information in the <code>/var/log/ngcp/panel.log</code> and <code>/var/log/ngcp/panel-debug.log</code> files when used via Admin Panel, or in the output of the <code>ngcp-provisioning-templates</code> script (depending on the <code>--log-level</code> option specified).</p>

<code>info()</code>	<i>String</i>	It prints 'info' log information in the <code>/var/log/ngcp/panel.log</code> and <code>/var/log/ngcp/panel-debug.log</code> files when used via Admin Panel, or in the output of the <code>ngcp-provisioning-templates</code> script (depending on the <code>--log-level</code> option specified).
<code>warn()</code>	<i>String</i>	It prints 'warning' log information in the <code>/var/log/ngcp/panel.log</code> and <code>/var/log/ngcp/panel-debug.log</code> files when used via Admin Panel, or in the output of the <code>ngcp-provisioning-templates</code> script (depending on the <code>--log-level</code> option specified).
<code>error()</code>	<i>String</i>	It prints 'error' log information in the <code>/var/log/ngcp/panel.log</code> and <code>/var/log/ngcp/panel-debug.log</code> files when used via Admin Panel, or in the output of the <code>ngcp-provisioning-templates</code> script (depending on the <code>--log-level</code> option specified).

**IMPORTANT**

For Perl, the following core functions are disabled to prevent harmful code injection: `binmode()`, `close()`, `closedir()`, `dbmclose()`, `dbmopen()`, `eof()`, `fileno()`, `flock()`, `format()`, `getc()`, `read()`, `readdir()`, `rewinddir()`, `say()`, `seek()`, `seekdir()`, `select()`, `syscall()`, `sysread()`, `sysseek()`, `syswrite()`, `tell()`, `telldir()`, `truncate()`, `write()`, `print()`, `printf()`, `chdir()`, `chmod()`, `chown()`, `chroot()`, `fcntl()`, `glob()`, `ioctl()`, `link()`, `lstat()`, `mkdir()`, `open()`, `opendir()`, `readlink()`, `rename()`, `rmdir()`, `stat()`, `symlink()`, `sysopen()`, `umask()`, `unlink()`, `utime()`, `alarm()`, `exec()`, `fork()`, `getpgrp()`, `getppid()`, `getpriority()`, `kill()`, `pipe()`, `setpgrp()`, `setpriority()`, `sleep()`, `system()`, `times()`, `wait()`, `waitpid()`, `accept()`, `bind()`, `connect()`, `getpeername()`, `getsockname()`, `getsockopt()`, `listen()`, `recv()`, `send()`, `setsockopt()`, `shutdown()`, `socket()`, `socketpair()`, `msgctl()`, `msgget()`, `msgrcv()`, `msgsnd()`, `semctl()`, `semget()`, `semop()`, `shmctl()`, `shmget()`, `shmread()`, `shmwrite()`, `endgrent()`, `endhostent()`, `endnetent()`, `endpwent()`, `getgrent()`, `getgrgid()`, `getgrnam()`, `getlogin()`, `getpwent()`, `getpwnam()`, `getpwuid()`, `setgrent()`, `setpwent()`, `endprotoent()`, `endservent()`, `gethostbyaddr()`, `gethostbyname()`, `gethostent()`, `getnetbyaddr()`, `getnetbyname()`, `getnetent()`, `getprotobyname()`, `getprotobynumber()`, `getprotoent()`, `getservbyname()`, `getservbyport()`, `getservent()`, `sethostent()`, `setnetent()`, `setprotoent()`, `setservent()`, `exit()`, `goto()`.

Finally, let us consider the following template section example:

*Code-Snippet Example.*

```
fields:
- name: cc
  label: "Country Code:"
  type: Text
  required: 1
- name: ac
  label: "Area Code:"
  type: Text
  required: 1
```

```

- name: sn
  label: "Subscriber Number:"
  type: Text
  required: 1
- name: sip_username
  type: calculated
  value_code: "function() {
                return row.cc.concat(row.ac).concat(row.sn);
              }"

```

Here, the text input fields `cc`, `ac` and `sn` along with the internal field `sip_username` are declared. It is required for this case that `sip_username` must be a string concatenation of the `cc`, `ac` and `sn` fields, respectively. Therefore, `sip_username` type is declared as `calculated` and its value must be declared through the `value_code` attribute name. This attribute shows a code snippet which contains a JavaScript function that performs the string concatenation. The `row` variable refers to the CSV file row, or the form input when filling out the data through Admin Panel. Finally, when the data is computed, it will be stored in the `value` attribute.

### 7.44.5. Batch Provisioning Via Admin Panel

Batch provisioning can be enabled as a global, system-wide configuration in the main configuration file (`config.yml`) through the `www_admin.batch_provisioning_features` property set to `1`. The feature is available for all administrative users of the platform, that covers users with generic administrator role and users with "customer care" role. These users will be referred as "admin users" later in this document.

When set, the Batch Provisioning page can be accessed through the *Tools* *Batch Provisioning* menu entry. The interface will offer the option to create a new provisioning template, or edit an existing one.

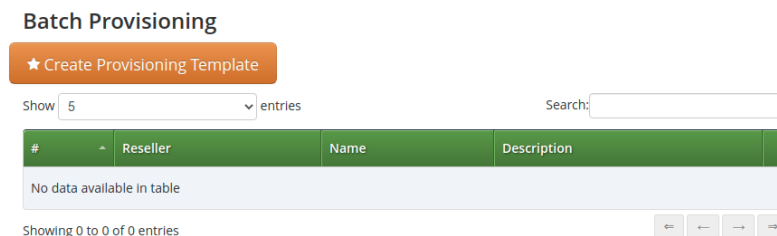

Figure 129. Main Batch Provisioning Page.

For creation, press on the 'Create Provisioning Template' button. This will pop-up a new window, as shown below.

#	Name	Contract #	Status	
1	default	1	active	<input checked="" type="checkbox"/>
13	k2	115	active	<input type="checkbox"/>

```

1 fields:
2   - name: first_name
3     label: "First Name:"
4     type: Text
5     required: 1
6   - name: last_name
7     label: "Last Name:"
8     type: Text
9     required: 1
10  - name: cc
11    label: "Country Code:"
12    type: Text
13    required: 1
14  - name: ac

```

Figure 130. Create Provisioning Template.

The parameters are as follows:

- **Reseller:** The reseller this template belongs to.
- **Name:** A free form string used to identify the provisioning template in the Admin Panel. This may be edited at any time.
- **Description:** Information about the provisioning template.
- **Language:** Scripting language used in the provisioning template for the 'calculated' fields. Either *JavaScript* (default) or *Perl*.
- **Template:** The provisioning template to be used. By default, there is a built-in template that has been created to set basic options. Please, check appendix for further details.

Once a template has been defined, there are two options available for data input:

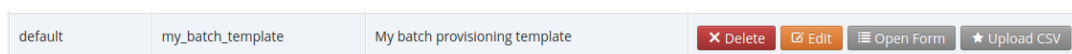

Figure 131. Provisioning Options.

### Manual Entry For A Single Subscriber

This option is available when clicking on the 'Open Form' button. A new window will be displayed to enter the variable data of the subscriber in several form fields:

Figure 132. Single Subscriber Provisioning.

The fields displayed will depend on what is defined on the provisioning template. If the default built-in template is in use, then parameters are as follows:

- **First Name:** The given name of the customer in which the subscriber will belong to.
- **Last Name:** The surname of the customer in which the subscriber will belong to.
- **Country Code (CC):** Country code of the subscriber telephone number.
- **Area Code (AC):** Area code of the subscriber telephone number.
- **Subscriber Number (SN):** Telephone number of the subscriber.
- **Terminate subscriber, if exists:** If ticked, it will terminate any existing subscriber with that name.

### Bulk Entry For More Subscribers

This option is available when clicking on the 'Upload CSV' button, which allows to upload a CSV file that contains a line of data for each subscriber. A new window will be displayed to enter the data:

Figure 133. Bulk Subscriber Provisioning.

The parameters are as follows:

- **CSV:** The CSV file to upload. The file has to follow the format defined in the template.
- **Purge Existing:** If ticked, it will terminate any existing subscribers with that name. This checkbox is equivalent to specify the value 1 in each row of the CSV file.

### 7.44.6. Batch Provisioning via CLI

NGCP offers the `ngcp-provisioning-template` command line tool for batch provisioning, which allows to run a 'provisioning template' from database or from config.yml file. This will produce a subscriber setup including required billing contact, contract, preferences, etc. from an input form defined by that template.

**Usage:**

For templates defined in *config.yml* file:

```
ngcp-provisioning-template "provisioning-template-name" [options]
```

For templates defined in database:

```
ngcp-provisioning-template "reseller-name/provisioning-template-name"
[options]
```

**NOTE**

For templates defined in database, different resellers could each have a provisioning template with the same name.

The form fields can be passed as command line options, as described below.

Table 30. Usage of The *ngcp-provisioning-template* Command.

Option	Description
<code>--help</code>	Prints a brief help message and exits.
<code>--db-host=db-host-IP-address</code>	The host of the ngcp database to connect to. If omitted, the database connection settings of <i>ngcp-panel</i> will be used.
<code>--db-port=db-host-port</code>	The port of the ngcp database to connect to. Only relevant if <code>--db-host</code> is specified.
<code>--db-user=db-username</code>	The database user for the ngcp database to connect to. Only relevant if <code>--db-host</code> is specified.
<code>--db-password=db-password</code>	The the database user password (if any) for the ngcp database to connect to. Only relevant if <code>--db-host</code> is specified.
<code>--file=csv-filename</code>	Specify a CSV filename to process. Each row represents form values for one subscriber to create.
<code>--[input-attribute-name]=[attribute-value]</code>	Provide an input attribute name and its value, as defined within the <code>fields</code> tag in the template (Attribute must not be internal, but form visible). Only relevant if no <code>--file</code> is specified.
<code>--purge</code>	Terminate an existing subscriber with duplicate number/aliases first.
<code>--log-level</code>	Verbosity level of printed messages while processing ( <code>error</code> , <code>warn</code> , <code>info</code> , <code>debug</code> ).

By default, database connection parameters are read from the `/etc/ngcp-panel/provisioning.conf` configuration file. For developing and/or testing reasons, it is possible though to use different database connection parameters, which can be specified with the `--db-*` arguments.

If no CSV file is specified with the `--file` option, each of the non-internal input parameters defined in the template (within the `fields` tag) can be provided as part of the command line options. For instance, if `first_name` input variable is declared in the template, then such option can be entered as `--first_name` (e.g. `--first_name=John`).

Batch provisioning is based on transactional processing. If provisioning fails at a specific point, it will rollback what was created up to that point, in order to avoid residual data in the database.

**TIP**

When developing a template, it is best to use the `ngcp-provisioning-template` script with debug enabled, since it is possible to check log messages directly on the command output.

Some examples for single subscriber use, and CSV-file use.

**Single subscriber (Debug level on):**

```
ngcp-provisioning-template "default/My Template" \
  --log-level=debug \
  --first_name=Peter \
  --last_name=White \
  --cc=43 \
  --ac=1 \
  --sn=2521523 \
  --purge
```

**CSV File (Debug level on):**

```
ngcp-provisioning-template "default/My Template" \
  --log-level=debug \
  --file=bulk.csv \
  --purge
```

**7.44.7. Batch Provisioning Via API**

Batch provisioning is also available in REST API through the `/api/provisioningtemplates/` path. Please, check API documentation for details about available HTTP methods, properties and query parameters.

The following sub-sections aim to highlight common use cases. Let us assume the following template base data will be used.

*Table 31. Example Of API Provisioning Data.*

Field	Value
Reseller	default
Reseller ID	1
SIP Domain	mydomain.com

Product	Basic SIP Account
Template Name	<i>My API Provisioning Template</i>
Template Language	js (JavaScript)
Template Content	Same as Built-in Template
API IP <Address:Port>	127.0.0.1:1443
API Key File	./apiclient.pem

## Template Creation

For template creation, the HTTP **POST** method is available. Template metadata can be specified in JSON notation using the **name**, **description**, **reseller\_id**, and **lang** attributes. Template definition can be provided in JSON notation within the **template** attribute, as shown below.

*Example of Template Creation via API.*

```
curl -ki --cert ./apiclient.pem -X POST \
-H 'Connection: close' \
-H 'Content-Type: application/json' \
"https://127.0.0.1:1443/api/provisioningtemplates/" \
--data-binary '{
  "description" : "My API-Created Template",
  "name" : "My API Provisioning Template",
  "reseller_id" : 1,
  "lang" : "js",
  "template" : {
    "fields" : [
      {
        "name" : "first_name",
        "label" : "First Name:",
        "type" : "Text",
        "required" : "1"
      },
      {
        "name" : "last_name",
        "label" : "Last Name:",
        "type" : "Text",
        "required" : "1"
      },
      {
        "label" : "Country Code:",
        "name" : "cc",
        "type" : "Text",
        "required" : "1"
      },
      {
        "name" : "ac",
        "label" : "Area Code:",
        "type" : "Text",
        "required" : "1"
      }
    ]
  }
}
```

```

    },
    {
      "name" : "sn",
      "label" : "Subscriber Number:",
      "type" : "Text",
      "required" : "1"
    },
    {
      "name" : "sip_username",
      "type" : "calculated",
      "value_code" : "function() { return
row.cc.concat(row.ac).concat(row.sn); }"
    },
    {
      "name" : "purge",
      "label" : "Terminate subscriber, if exists:",
      "type" : "Boolean"
    }
  ],
  "contract_contact" : {
    "identifier" : "firstname, lastname, status",
    "reseller" : "default",
    "firstname_code" : "function() { return row.first_name; }",
    "lastname_code" : "function() { return row.last_name; }",
    "status" : "active"
  },
  "contract" : {
    "product" : "Basic SIP Account",
    "billing_profile" : "Default Billing Profile",
    "identifier" : "contact_id",
    "contact_id_code" : "function() { return contract_contact.id; }"
  },
  "subscriber" : {
    "domain" : "mydomain.com",
    "primary_number" : {
      "cc_code" : "function() { return row.cc; }",
      "ac_code" : "function() { return row.ac; }",
      "sn_code" : "function() { return row.sn; }"
    },
    "username_code" : "function() { return row.sip_username; }",
    "password_code" : "function() { return row.sip_password; }"
  },
  "subscriber_preferences" : {
    "gpp0" : "test"
  }
}
}'

```

### Template Request

For template request, the HTTP **GET** method is available. A specific template can be fetched according

the id value of the template, which corresponds to the concatenation of reseller name, the / symbol and the template name. Based on the previous example creation, the corresponding value is "default/My API Provisioning Template".

*Example of Template Request via API.*

```
curl -ki --cert ./apiclient.pem -X GET \
  -H 'Connection: close' \
  "https://127.0.0.1:1443/api/provisioningtemplates/default/My API
Provisioning Template/"
```

#### NOTE

On batch provisioning templates, the **id** parameter is a *String* type (Rather than an *Integer* type, as commonly used on other API commands).

**GET** method will output the template definition within the template attribute, which output format can be controlled by using the **?format=[value]** directive. The available values are: **yml**, **yaml** or **json**. Example:

```
curl -ki --cert ./apiclient.pem -X GET \
  -H 'Connection: close' \
  "https://127.0.0.1:1443/api/provisioningtemplates/default/My API
Provisioning Template/?format=json"
```

Additionally, as templates can be stored on database or in config.yml file, it is possible to use the Boolean editable parameter to list: (a) Database-stored templates only (**true**); or (b) Templates defined on config.yml file only (**false**). Example:

```
curl -ki --cert ./apiclient.pem -X GET \
  -H 'Connection: close' \
  "https://127.0.0.1:1443/api/provisioningtemplates/?editable=false"
```

#### NOTE

Templates defined on config.yml will be displayed on Admin Panel, but they cannot be edited.

## Template Update

For template update, the HTTP **PUT** and **PATCH** methods are available.

For **PUT**, it is possible to set the whole template at once only. Let us assume that the **gpp0** attribute (located within the **subscriber\_preferences** tag) will be modified to other value, meanwhile the rest of template properties will remain the same.

*Example of Template Update Via API (PUT).*

```
curl -ki --cert ./apiclient.pem -X PUT \
  -H 'Connection: close' \
  -H 'Content-Type: application/json' \
```

```

"https://127.0.0.1:1443/api/provisioningtemplates/default/My API
Provisioning Template/" \
--data-binary '{
  "description" : "My API-Created Template",
  "name" : "My API Provisioning Template",
  "reseller_id" : 1,
  "lang" : "js",
  "template" : {
    "fields" : [
      {
        "name" : "first_name",
        "label" : "First Name:",
        "type" : "Text",
        "required" : "1"
      },
      {
        "name" : "last_name",
        "label" : "Last Name:",
        "type" : "Text",
        "required" : "1"
      },
      {
        "label" : "Country Code:",
        "name" : "cc",
        "type" : "Text",
        "required" : "1"
      },
      {
        "name" : "ac",
        "label" : "Area Code:",
        "type" : "Text",
        "required" : "1"
      },
      {
        "name" : "sn",
        "label" : "Subscriber Number:",
        "type" : "Text",
        "required" : "1"
      },
      {
        "name" : "sip_username",
        "type" : "calculated",
        "value_code" : "function() { return
row.cc.concat(row.ac).concat(row.sn); }"
      },
      {
        "name" : "purge",
        "label" : "Terminate subscriber, if exists:",
        "type" : "Boolean"
      }
    ],
    "contract_contact" : {

```

```

    "identifier" : "firstname, lastname, active",
    "reseller" : "default",
    "firstname_code" : "function() { return row.first_name; }",
    "lastname_code" : "function() { return row.last_name; }",
    "status" : "active"
  },
  "contract" : {
    "product" : "Basic SIP Account",
    "billing_profile" : "Default Billing Profile",
    "identifier" : "contact_id",
    "contact_id_code" : "function() { return contract_contact.id; }"
  },
  "subscriber" : {
    "domain" : "mydomain.com",
    "primary_number" : {
      "cc_code" : "function() { return row.cc; }",
      "ac_code" : "function() { return row.ac; }",
      "sn_code" : "function() { return row.sn; }"
    },
    "username_code" : "function() { return row.sip_username; }",
    "password_code" : "function() { return row.sip_password; }"
  },
  "subscriber_preferences" : {
    "gpp0" : "My new gpp0 value"
  }
}
}'

```

For **PATCH**, it is possible to modify main template attributes at once only. Sub-attributes belonging to a section will need to be replaced as a whole. Let us assume that the **description** attribute and the **gpp0** attribute (located within the **template.subscriber\_preferences** section) will be updated to different values, respectively.

*Example of Template Update Via API (PATCH).*

```

curl -ki --cert ./apiclient.pem -X PATCH \
  -H 'Connection: close' \
  -H 'Content-Type: application/json-patch+json' \
  "https://127.0.0.1:1443/api/provisioningtemplates/default/My API
Provisioning Template/" \
  --data-binary '[
  { "op" : "replace", "path" : "/description", "value" : "My new
description for API-Created Template" },
  { "op" : "replace", "path" : "/template", "value" : {
    "fields" : [
      {
        "name" : "first_name",
        "label" : "First Name:",
        "type" : "Text",
        "required" : "1"
      }
    ]
  }
},

```

```

    {
      "name" : "last_name",
      "label" : "Last Name:",
      "type" : "Text",
      "required" : "1"
    },
    {
      "label" : "Country Code:",
      "name" : "cc",
      "type" : "Text",
      "required" : "1"
    },
    {
      "name" : "ac",
      "label" : "Area Code:",
      "type" : "Text",
      "required" : "1"
    },
    {
      "name" : "sn",
      "label" : "Subscriber Number:",
      "type" : "Text",
      "required" : "1"
    },
    {
      "name" : "sip_username",
      "type" : "calculated",
      "value_code" : "function() { return
row.cc.concat(row.ac).concat(row.sn); }"
    },
    {
      "name" : "purge",
      "label" : "Terminate subscriber, if exists:",
      "type" : "Boolean"
    }
  ],
  "contract_contact" : {
    "identifier" : "firstname, lastname, status",
    "reseller" : "default",
    "firstname_code" : "function() { return row.first_name; }",
    "lastname_code" : "function() { return row.last_name; }",
    "status" : "active"
  },
  "contract" : {
    "product" : "Basic SIP Account",
    "billing_profile" : "Default Billing Profile",
    "identifier" : "contact_id",
    "contact_id_code" : "function() { return contract_contact.id; }"
  },
  "subscriber" : {
    "domain" : "mydomain.com",
    "primary_number" : {

```

```

        "cc_code" : "function() { return row.cc; }",
        "ac_code" : "function() { return row.ac; }",
        "sn_code" : "function() { return row.sn; }"
    },
    "username_code" : "function() { return row.sip_username; }",
    "password_code" : "function() { return row.sip_password; }"
},
"subscriber_preferences" : {
    "gpp0" : "My new gpp0 value"
}
}
}
]'
```

## Template Deletion

For template deletion, the HTTP **DELETE** method is available. It is required to provide the **id** value (*String*) of the template. Based on the examples, the value is "default/My API Provisioning Template".

*Example of Template Deletion Via API.*

```

curl -ki --cert ./apiclient.pem -X DELETE \
  -H 'Connection: close' \
  "https://127.0.0.1:1443/api/provisioningtemplates/default/My API
Provisioning Template/"
```

## API Data Provisioning: Single Subscriber

A **POST** can be requested to provision a single subscriber by using JSON. Let us assume that the following single subscriber data will be provisioned:

*Table 32. Example Of Single Subscriber Provisioning Via API.*

Customer Contact Info		Subscriber			Purge?
First Name	Surname	CC	AC	SN	
Mark	Brown	56	2	33445511	yes

Then, the corresponding API command will be:

*Example of Single Subscriber Provisioning Via API.*

```

curl -ki --cert ./apiclient.pem -X POST \
  -H 'Connection: close' \
  -H 'Content-Type: application/json' \
  "https://127.0.0.1:1443/api/provisioningtemplates/default/My API
Provisioning Template/" \
  --data-binary '{
    "first_name" : "Mark" ,
```

```
"last_name" : "Brown" ,
"cc" : "56" ,
"ac" : "2",
"sn" : "33445511" ,
"purge" : true
}'
```

### API Data Provisioning: Batch of Subscribers

To bulk-upload subscribers, it is required to specify the Content-Type as `text/csv` and POST the CSV file in the request body. Let us assume that the following subscriber data will be provisioned in the `bulk.csv` file:

Table 33. Example Of Bulk Subscriber Provisioning Via API.

Customer Contact Info		Subscriber(s)			Purge?
First Name	Surname	CC	AC	SN	
James	Smith	56	2	33445511	yes
Richard	Stone	56	2	33445522	yes
John	Doe	43	123	1001 1002 1003 1004 1005	yes

The CSV file will contain:

```
James, Smith, 56, 2, 33445511, 1
Richard, Stone, 56, 2, 33445522, 1
John, Doe, 43, 123, 1001, 1
John, Doe, 43, 123, 1002, 1
John, Doe, 43, 123, 1003, 1
John, Doe, 43, 123, 1004, 1
John, Doe, 43, 123, 1005, 1
```

Then, the corresponding API command will be:

Example of Bulk Subscriber Provisioning Via API.

```
curl -ki --cert ./apiclient.pem -X POST \
-H 'Connection: close' \
-H 'Content-Type: text/csv' \
"https://127.0.0.1:1443/api/provisioningtemplates/default/My API
Provisioning Template/" \
--data-binary '@./bulk.csv'
```

## 7.45. Call List Suppressions

### 7.45.1. Overview

Call List Suppressions allows to filter specific numbers from Call History and Invoices. The feature aims to support country regulations such as gene violation or abuse of women, in which calls made to specific service numbers should not be made visible in any way to the aggressor.

The feature can be set via Admin Panel.

Its main advantages are as follows:

#### (a) Filter Calls.

Matched call numbers (against a regular expression) will not appear at all.

#### (b) Obfuscate Calls.

Matched call numbers (against a regular expression) will be replaced by a given label.

The following sections will provide more details about the feature.

### 7.45.2. Provisioning via Admin Panel

Call List Suppressions can be accessed at *Settings* *Call List Suppressions* section. The interface will offer the option to create a new entry, edit any of the existing ones, or upload/download via CSV.

The screenshot shows the 'Global Call List Suppressions' interface. At the top, there are four orange buttons: 'Back', 'Create call list suppression', 'Download CSV', and 'Upload CSV'. Below these buttons, there is a 'Show' dropdown menu set to '5' and a 'Search:' input field. A table with columns '#', 'Domain', 'Direction', 'Pattern', 'Mode', and 'Label' is displayed, but it is currently empty, showing 'No data available in table'. At the bottom, it says 'Showing 0 to 0 of 0 entries' and has four navigation arrows.

Figure 134. Call List Suppressions.

### 7.45.3. Single Entry

For creation, press on the "Create call list suppression" button, which will pop-up a new window, as shown below.

Figure 135. Subscriber Location Mappings: Create Entry.

Parameters are as follows:

- **Domain:** The domain of subscribers in which this call list suppression applies to. An empty domain means to apply it to subscribers of any domain.
- **Direction:** The direction (**outgoing** or **incoming**) of calls this call list suppression applies to.
- **Pattern:** A regular expression the dialed number (CDR **destination\_user\_in** field) has to match in case of **outgoing** direction, or the inbound number (CDR **source\_cli** field) in case of incoming direction.
- **Mode:** It defines the suppression mode. For subscriber and subscriber admins, The **filter** option means that matching calls will not appear at all, while the **obfuscate** option means that the number is replaced by the given label. Also, the mode can be disabled by selecting the **disabled** option.
- **Label:** A string name to be defined for this list. Admin and reseller users see it for **filter** mode suppressions. For the **obfuscate mode**, this label will be used as a replacement string.

#### 7.45.4. Bulk Entry

This option is available when clicking on the "Upload CSV" button, which allows to upload a CSV file that contains a line of data for each list. A new window will be displayed to enter the data:

Figure 136. Bulk Provisioning.

The parameters are as follows:

- **CSV:** The CSV file to upload. The file has to follow the same order as defined for single entries.

- **Purge Existing:** If ticked, it will delete any existing list before provisioning the new one.

### 7.45.5. Practical Example

Let us assume that an administrator will use Admin Panel to provision two call list suppression on a selected number. The following details are considered:

Table 34. Practical Example - Input Data.

Domain	Direction	Pattern	Mode	Label
voipdomain.com	outgoing	^571016\$	filter	cls-a
voipdomain.com	outgoing	^571017\$	obfuscate	cls-b

In the provided example, the logic is as following:

Table 35. Practical Example - Logic & Result.

Logic	Result
<ul style="list-style-type: none"> <li>• An outgoing call to the destination number 571016 is made.</li> </ul>	<ul style="list-style-type: none"> <li>• The call will not be shown in the call history (<i>Conversations</i> section) of the Customer Self-Care interface.</li> <li>• An NGCP administrator will be able to see the call in the call history via Admin Panel, with the label "<i>filtered: cls-a</i>".</li> <li>• The call will not be shown on NGCP-generated invoices.</li> </ul>
<ul style="list-style-type: none"> <li>• An outgoing call to the destination number 571017 is made.</li> </ul>	<ul style="list-style-type: none"> <li>• The call will be shown in the call history (<i>Conversations</i> section) of the Customer Self-Care interface as "<i>Call to cls-b</i>".</li> <li>• An NGCP administrator will be able to see the call in the call history, with the label "<i>obfuscated: cls-b</i>".</li> <li>• The call will be shown as "<i>cls-b</i>" in NGCP-generated invoices.</li> </ul>

## 7.46. Message Body Filtering

In some cases it is required to filter out from message bodies some specific multipart/mixed body because not supported by the endpoints. This can be simply achieved using the config.yml option `kamailio.lb.filter_content_type`. The filter will be executed on:

- all the INVITE requests that contains body
- all the replies with return code 200 and 183 that contains body

To configure it, proceed following the next steps:

1. set the `kamailio.lb.filter_content_type.enable` option to 'yes'.
2. set the `kamailio.lb.filter_content_type.action` to 'filter' or 'drop'. If one of the listed content-type is found, the first option will strip out all the bodies expect for application/sdp from the message, the second one will simply drop the message.
3. list in `kamailio.lb.filter_content_type.content_type_list` the content\_types and the direction (request, reply or all) where the action has to be applied.
4. apply the changes executing `ngcpcfg apply 'enabled filter_content_type'`.

**NOTE** | The action 'drop' works only for 'requests' and not for 'replies'.

For example, to filter out from all the reply messages the 'application/isup' content-type and from all the messages the 'application/vnd.etsi.cug+xml', you have to configure the following:

```
kamailio:
  lb:
    filter_content_type:
      enable: yes
      action: filter (or drop)
      content_type_list:
        - content_type: application/isup
          direction: reply
        - content_type: application/vnd.etsi.cug+xml
          direction: all
```

**NOTE** | `kamailio.lb.filter_content_type` definition substitutes the already existing `kamailio.lb.remove_isup_body_from_replies`, extending its functionality to other content types. The migration from the previous setting to the new one is automatically done during the upgrade.

## 7.47. Generation of 181 Call Is Being Forwarded

### 7.47.1. Overview

SIP message '181 - Call Is Being Forwarded' is an optional provisional response that can be sent towards the caller user to inform it of an ongoing call forward. The message can also contain History-Info headers necessary to the caller to identify which is the new destination of the call.

### 7.47.2. How to enable it

By default Sipwise C5 doesn't generate any 181 message. To enable this feature two steps are required:

- set config.yml option 'kamailio.proxy.cf\_send\_181.enable' to 'yes'
- set config.yml option 'b2b.sbc.reset\_tag\_on\_fork' to 'yes'
- set the option 'outbound\_history\_info' in subscriber/domain/peer preferences

The first preference will actually activate the 181 message generation. The second one, instead, allows SEMS to forward back to caller all the provisional messages even if they contain a different To-Tag. Without this second preference set, the 181 message is sent towards the caller but all the following 18x messages are blocked by SEMS. The third one adds the History-Info headers with the information of the forwarded and of the final destination to the 181 message.

### 7.47.3. How it works

When a call forward is triggered in Sipwise C5, Kamailio Proxy stores in the Redis database, which is selected by 'kamailio.proxy.cf\_send\_181.redis\_db' preference in config.yml, the History-Info headers that are added to the outgoing INVITE message. Kamailio LB receives the outgoing INVITE and it generates a '182 - Connecting' message back towards the caller. The 182 message is received by Kamailio Proxy that converts it in a '181 - Call Is Being Forwarded' message and adds the History-Info headers previously stored in the Redis DB, if any. The message is then sent back to the caller.

# Chapter 8. Extra Modules

## 8.1. Cloud PBX

The Sipwise C5 comes with a commercial Cloud PBX module to provide B2B features for small and medium sized enterprises. The following chapters describe the configuration of the PBX features.

### 8.1.1. PBX Device Provisioning

#### How it works

A device gets provisioned with the following steps:

- Your customer creates a PBX device for a supported model and inputs a device's MAC address.
- Sipwise C5 sends the provided MAC address to the device vendor (e.g. [api.eds.al-enterprise.com](http://api.eds.al-enterprise.com), [rps.yealink.com](http://rps.yealink.com) or [sraps.snom.com](http://sraps.snom.com)).
- When the corresponding device is connected to the network, the device fetches the provisioning URL from the vendor site.
- The device downloads its specific configuration and the firmware from Sipwise C5.
- The phone updates the firmware and automatically sets the SIP proxy server, username and password and other SIP parameters received from Sipwise C5.

PBX device provisioning requires appropriate device models, firmwares, configurations and profiles to be added to the system.

A *device model* defines a specific hardware device, like the vendor, the model name, the number of keys and their capabilities. For example, a Cisco SPA504G has 4 keys, which can be used for private lines, shared lines (SLA) and busy lamp field (BLF). If you have an additional attendant console, you get 32 more buttons, which can only do BLF. The list of supported devices can be found in [List of available pre-configured devices](#).

A *device firmware* is used to update a potentially outdated factory firmware on a device. The default firmwares included in Sipwise C5 were tested with the provided device configurations and hence guarantee that all the supported features work as expected. That is why we recommend using the default firmwares and device configurations provided by Sipwise.

To make device provisioning easy-to-use for end-users, they do not have to care about firmwares or configurations mentioned above. Instead, you provide a *device profile* for every supported device model and associate such a device profile with a specific device configuration and firmware. When a customer employee with administrative rights provisions PBX devices for the company, they select the corresponding device profiles and specifies MAC addresses if necessary. Sipwise C5 will take care of the rest.

Sipwise C5 is supplied with a set of supported device models, their firmwares, configurations and profile. You can enable them and your customers will be able to use PBX device provisioning immediately.

To perform basic configuration and upload the set for a specific vendor, device model(s) or for all supported devices, execute the steps described in the following section.

## Initial device provisioning configuration

Execute the following initial steps before your customers can easily and securely provision their PBX devices:

1. Set the certificates and the keys for your HTTPs FQDN
2. Upload the required device models/firmwares/configurations/profiles

## Set the certificates and the key for your web domain

You can create new ones or use the existing certificate and the key for your web FQDN.

- Put the required files into the `/etc/ngcp-config/shared-files/ssl` folder.
- Specify the paths to the files and the FQDN in the following `config.yml` parameters:

### **server\_certfile**

### **server\_keyfile**

Specify the FQDN in **autoprov.server.host**

Optionally, enable **autoprov.server.nginx\_debug**

The final configuration should look similar to this one:

```
autoprov:
  hardphone:
    skip_vendor_redirect: no
    skip_vendor_ssl_verify: []
    skip_vendor_ssl_verify_hostname: []
  server:
    bootstrap_port: '1445'
    cisco_port: '1447'
    client_ca_certfile: /etc/ngcp-config/shared-files/ssl/client-auth-
ca.crt
    host: portal.yourdomain.com
    nginx_debug: yes
    port: '1444'
    server_ca_certfile: /etc/ngcp-config/shared-files/ssl/my_server.crt
    server_certfile: /etc/ngcp-config/shared-files/ssl/certificate.pem
    server_certfile_cisco: /etc/ngcp-config/shared-
files/ssl/certificate_cisco.pem
    server_keyfile: /etc/ngcp-config/shared-files/ssl/private_key.pem
    server_keyfile_cisco: /etc/ngcp-config/shared-
files/ssl/private_key_cisco.pem
    ssl_enabled: yes
    ssl_mac_check: no
  softphone:
    config_lockdown: '0'
    webauth: '0'
```

- Apply and push the changes

```
ngcpcfg apply 'PBX device provisioning configuration'  
ngcpcfg push all
```

### Upload the required device items

To upload device models/firmwares/configurations/profiles for devices with ZTP support, you need to obtain credentials from the corresponding vendor or its local distributor in advance. These credentials are required to send information about your devices and their provisioning URLs to the corresponding ZTP/RPS systems.

The script `ngcp-insert-pbx-devices` will insert the specified items into the database. For example, to upload items for all supported Yealink devices for the default reseller, execute the script with the following parameters on your management node (standby on PRO; web01a/db01a on CARRIER):

```
ngcp-insert-pbx-devices --api-user youruser --api-pass yourpassword  
--yealink-user user --yealink-password password
```

#### TIP

Execute `ngcp-insert-pbx-devices --help` to find other useful parameters, e.g. `--device-models`, `--resellers` and others.

## 8.1.2. Preparing PBX Rewrite Rules

In a PBX environment, the dial-plans usually looks different than for normal SIP subscribers. PBX subscribers should be able to directly dial internal extensions (e.g. 100) instead of the full number to reach another PBX subscriber in the same PBX segment. Therefore, we need to define specific *Rewrite Rules* to make this work.

The PBX dial plans are different from country to country. In the Central European area, you can directly dial an extension (e.g. 100), and if you want to dial an international number like 0049 1 23456, you have to dial a break-out digit first (e.g. 0), so the number to be dialed is 0 0049 1 23456. Other countries are used to other break-out codes (e.g. 9), which then results in 9 0049 1 23456. If you dial a national number like 01 23456, then the number to actually be dialed is 9 01 23456.

Since all numbers must be normalized to E.164 format via inbound rewrite rules, the rules need to be set up accordingly.

As with normal SIP accounts, you can use variables like `${caller_cc}` and `${caller_ac}`. For PBX subscribers, there is an additional variable `${caller_cloud_pbx_base_cli}`, which is the primary number of the administrative subscriber for a PBX customer. When you create this *pilot subscriber*, you can specify the primary number and a list of alias numbers. If the customer creates his own extensions by himself, he only has to provide the extension number, which will be appended to the primary number of the pilot subscriber, and which in turn forms the primary number of the extension subscriber. So if the pilot subscriber's primary number is 49 1 23456, and he creates a new extension subscriber with extension 100, the primary number of the extension will be 49 1 23456100. If another extension of this customer dials 100, you can prefix that with `${caller_cloud_pbx_base_cli}`, so the 100 gets normalized to 49 1 23456100 and the correct extension subscriber can be matched. You will learn more about number assignment for PBX subscribers in the following sections, when the creation of them is shown.

Let's assume that the break-out code for the example customers created below is 0, so we have to create a *Rewrite Rule Set* with the following rules.

## Inbound Rewrite Rules for Caller

PBX devices usually send their SIP URI (e.g. myuser@mydomain.org) as initiating CLI, so nothing special is to be done here. If you have PBX devices which only send their extension number (e.g. 100) as CLI, you need to prefix that with the `${caller_cloud_pbx_base_cli}` variable, like this:

- **Match Pattern:** `^([1-9][0-9]+)$`
- **Replacement Pattern:** `${caller_cloud_pbx_base_cli}\1`
- **Description:** extension to e164
- **Direction:** Inbound
- **Field:** Caller

Logged in as administrator Logout

sip:wise NGCP Dashboard

Settings

### Rewrite Rules for pbx-at

← Back ★ Create Rewrite Rule Expand Groups

Rewrite rule successfully created

	Match Pattern	Replacement Pattern	Description
↑ ↓	<code>^([1-9][0-9]+)\$</code>	<code>\${caller_cloud_pbx_base_cli}\1</code>	extension to e164

Inbound Rewrite Rules for Callee

Outbound Rewrite Rules for Caller

Outbound Rewrite Rules for Callee

Figure 137. Inbound Rewrite Rule for Caller

## Inbound Rewrite Rules for Callee

These rules are the most important ones, as they define which number formats the PBX subscribers can dial. For the break-out code of 0, the following rules are necessary e.g. for German dialplans to allow pbx internal extension dialing, local area calls without area codes, national calls with area code, and international calls with country codes.

*PBX internal extension dialin*

- **Match Pattern:** `^([1-9][0-9]+)$`
- **Replacement Pattern:** `${caller_cloud_pbx_base_cli}\1`
- **Description:** extension to e164
- **Direction:** Inbound
- **Field:** Callee

*Local dialing without area code (use break-out code 0)*

- **Match Pattern:** `^0([1-9][0-9]+)$`
- **Replacement Pattern:** `${caller_cc}${caller_ac}\1`
- **Description:** local to e164
- **Direction:** Inbound
- **Field:** Callee

*National dialing (use break-out code 0 and prefix area code by 0)*

- **Match Pattern:** `^00([1-9][0-9]+)$`
- **Replacement Pattern:** `${caller_cc}\1`
- **Description:** national to e164
- **Direction:** Inbound
- **Field:** Callee

*International dialing (use break-out code 0 and prefix country code by 00)*

- **Match Pattern:** `^000([1-9][0-9]+)$`
- **Replacement Pattern:** `\1`
- **Description:** international to e164
- **Direction:** Inbound
- **Field:** Callee

Logged in as administrator Logout

sip:wise NGCP Dashboard

Settings

## Rewrite Rules for pbx-at

← Back ★ Create Rewrite Rule Expand Groups

Rewrite rule successfully created

Inbound Rewrite Rules for Caller

Inbound Rewrite Rules for Callee

	Match Pattern	Replacement Pattern	Description	
↑ ↓	<code>^([1-9][0-9]+)\$</code>	<code>\${caller_cloud_pbx_base_cli}\1</code>	internal to e164	
↑ ↓	<code>^0([1-9][0-9]+)\$</code>	<code>\${caller_cc}\${caller_ac}\1</code>	local to e164	
↑ ↓	<code>^00([1-9][0-9]+)\$</code>	<code>\${caller_cc}\1</code>	national to e164	
↑ ↓	<code>^000([1-9][0-9]+)\$</code>	<code>\1</code>	internal to e164	

Figure 138. Inbound Rewrite Rule for Callee

### Outbound Rewrite Rules for Caller

When a call goes to a PBX subscriber, it needs to be normalized in a way that it's call-back-able, which means that it needs to have the break-out code prefixed. We create a rule to show the calling number in international format including the break-out code. For PBX-internal calls, the most common setting is to show the short extension of the caller and caller name that is provisioned to a PBX subscriber (in order to do that set domain preferences `outbound_from_display` and `outbound_from_user` accordingly, so you don't have to worry about that in rewrite rules).

*Adding a break-out code (use break-out code 0 and prefix country code by 00)*

- **Match Pattern:** `^([1-9][0-9]+)$`
- **Replacement Pattern:** `000\1`
- **Description:** `e164 to full international`
- **Direction:** `Outbound`
- **Field:** `Caller`

	Match Pattern	Replacement Pattern	Description	Enabled	
↑ ↓	^@{callee_cloud_pbx_account_cli_list}\$	\${caller_cloud_pbx_ext}	Intra-PBX to extension	yes	
↑ ↓	^([1-9][0-9]+)\$	000\1	e164 to full international	yes	

Figure 139. Outbound Rewrite Rule for Caller

Create a new *Rewrite Rule Set* for each dial plan you'd like to support. You can later assign it to customer domains and even to subscribers, if a specific subscriber of a PBX customer would like to have his own dial plan.

### 8.1.3. Creating Customers and Pilot Subscribers

As with a normal SIP Account, you have to create a *Customer* contract per customer, and one *Subscriber*, which the customer can use to log into the web interface and manage his PBX environment.

#### Creating a PBX Customer

Go to *SettingsCustomers* and click *Create Customer*. We need a *Contact* for the customer, so press *Create Contact*.

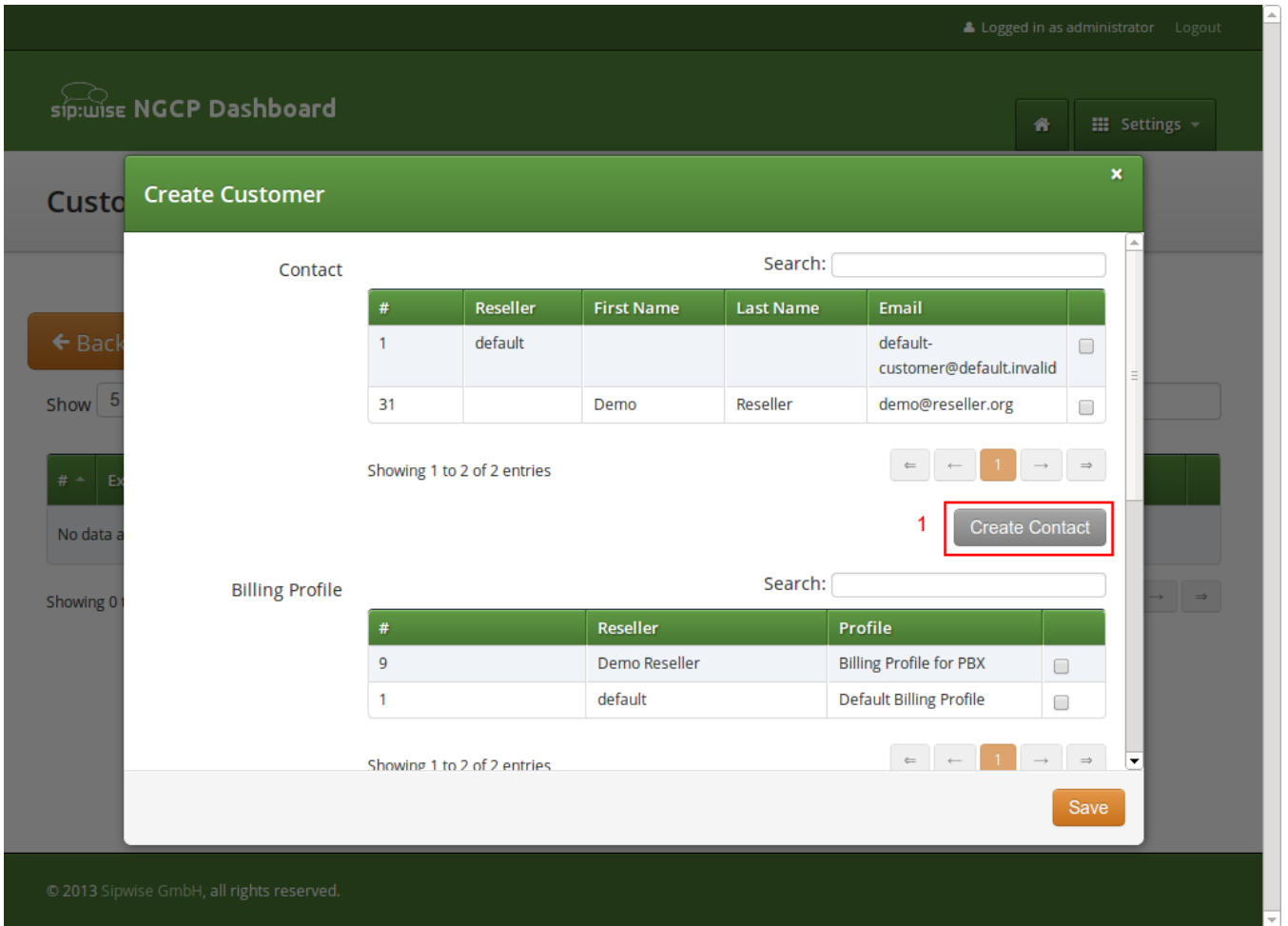

Figure 140. Create PBX Customer Part 1

Fill in the desired fields (you need to provide at least the *Email Address*) and press *Save*.

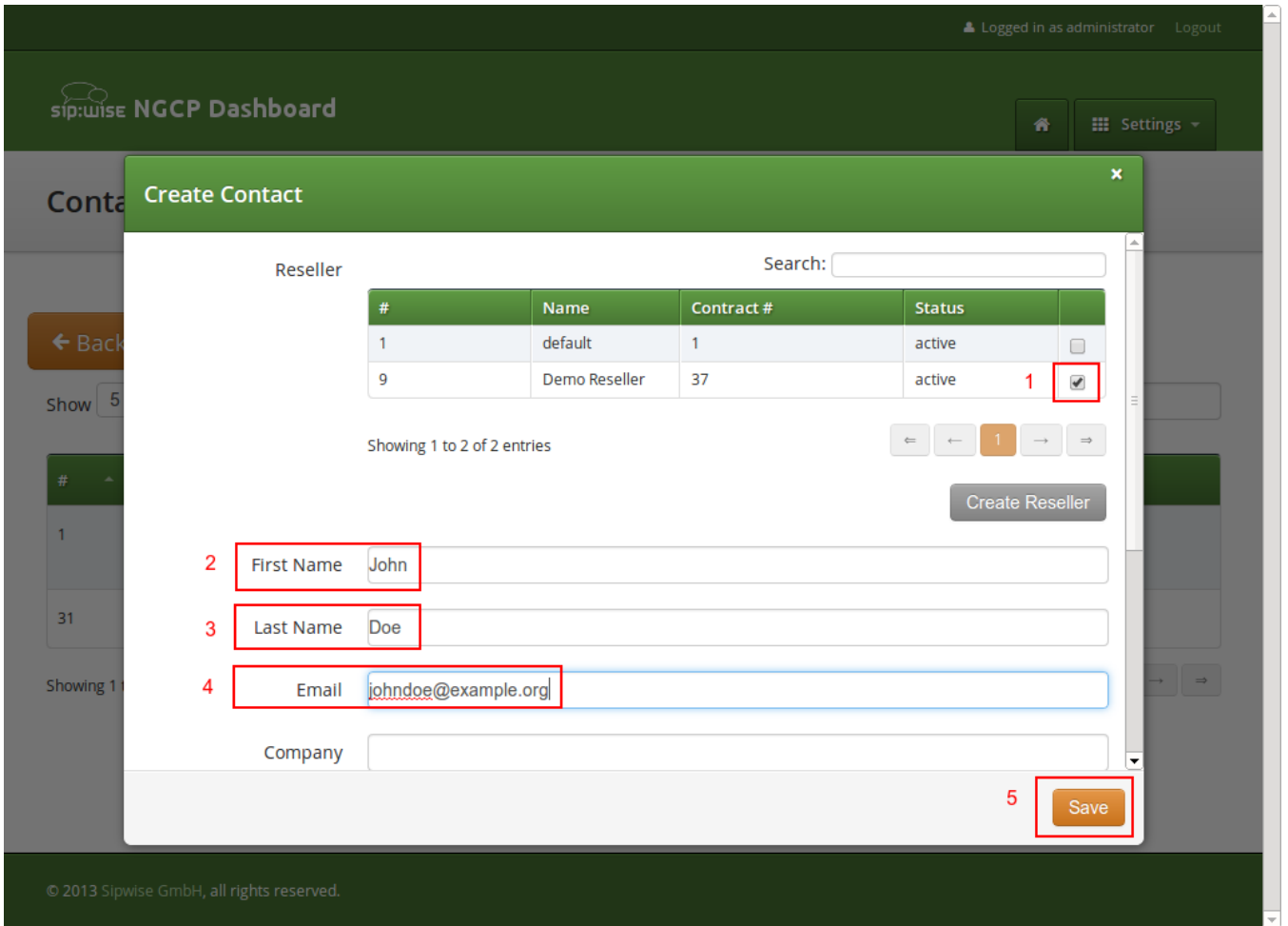

Figure 141. Create PBX Customer Contact

The new *Contact* will be automatically selected now. Also select a *Billing Profile* you want to use for this customer. If you don't have one defined yet, press *Create Billing Profile*, otherwise select the one you want to use.

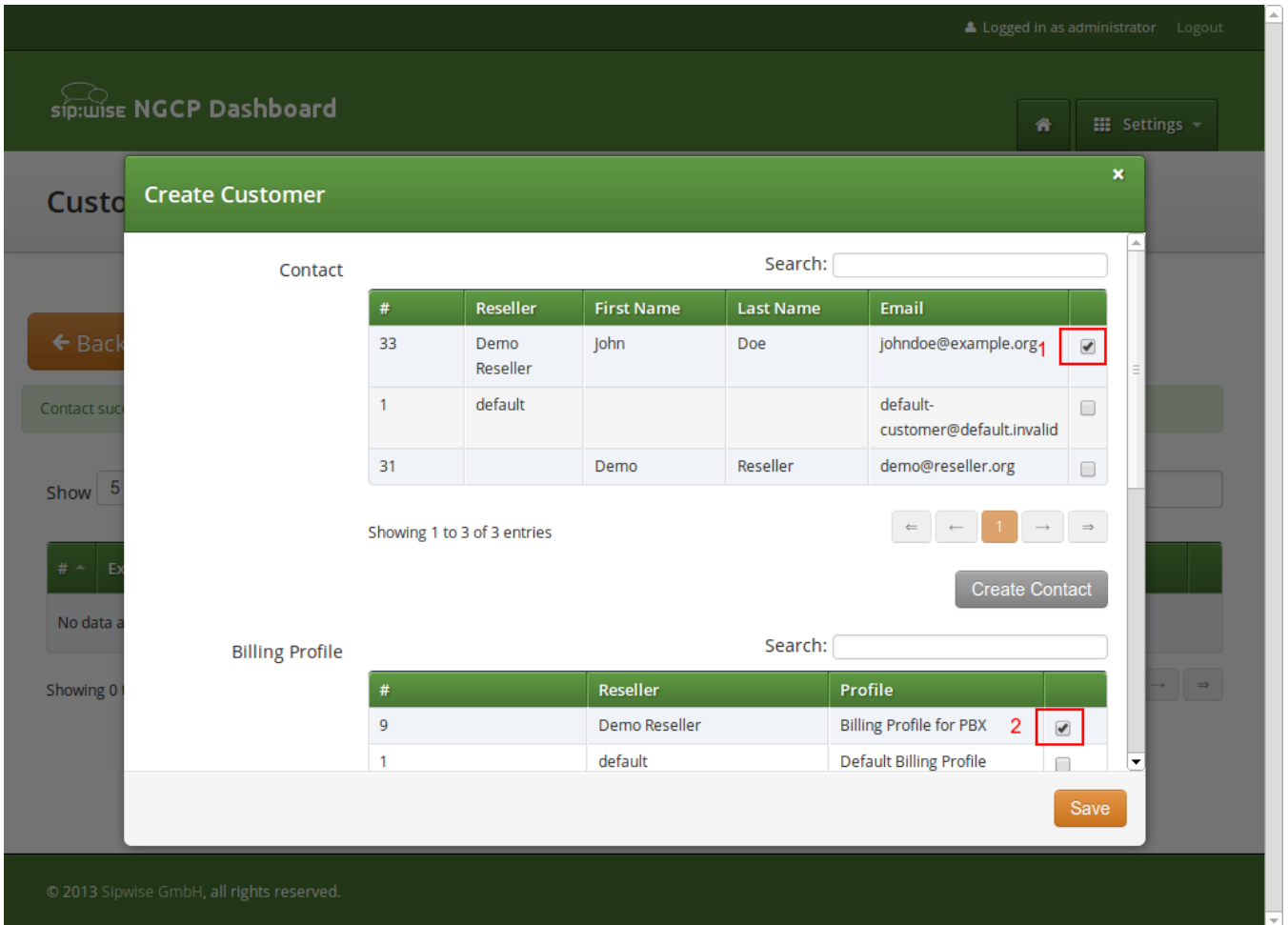

Figure 142. Create PBX Customer Part 2

Next, you need to select the *Product* for the PBX customer. Since it's going to be a PBX customer, select the product *Cloud PBX Account*.

Since PBX customers are supposed to manage their subscribers by themselves, they are able to create them via the web interface. To set an upper limit of subscribers a customer can create, define the value in the *Max Subscribers* field.

### IMPORTANT

As you will see later, both PBX subscribers and PBX groups are normal subscribers, so the value defined here limits the overall amount of subscribers **and** groups. A customer can create an unlimited amount of subscribers if you leave this field empty.

Press *Save* to create the customer.

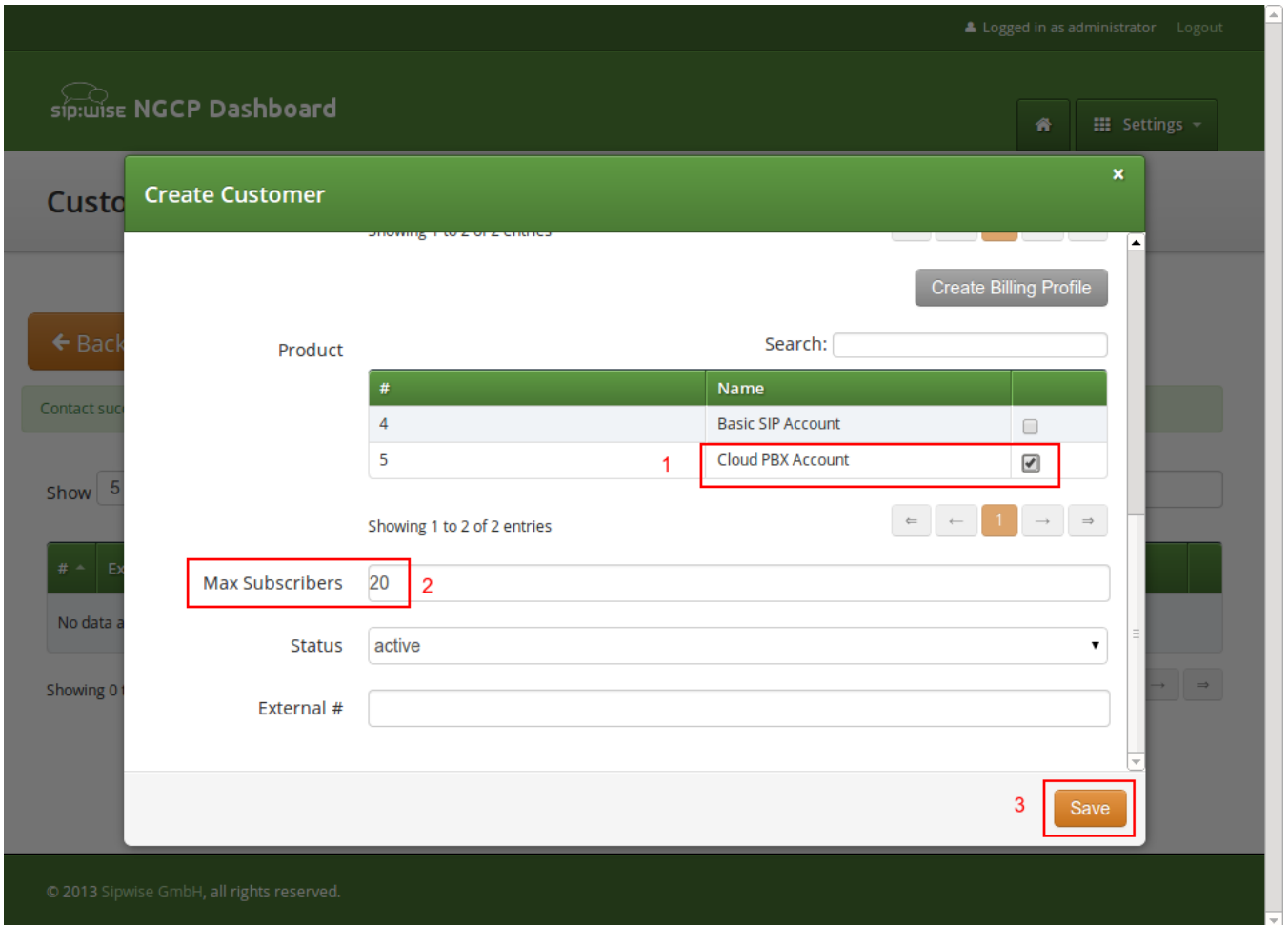

Figure 143. Create PBX Customer Part 3

### Creating a PBX Pilot Subscriber

Once the customer is created, you need to create at least one *Subscriber* for the customer, so he can log into the web interface and manage the rest by himself.

Click the *Details* button on the newly created customer to enter the detailed view.

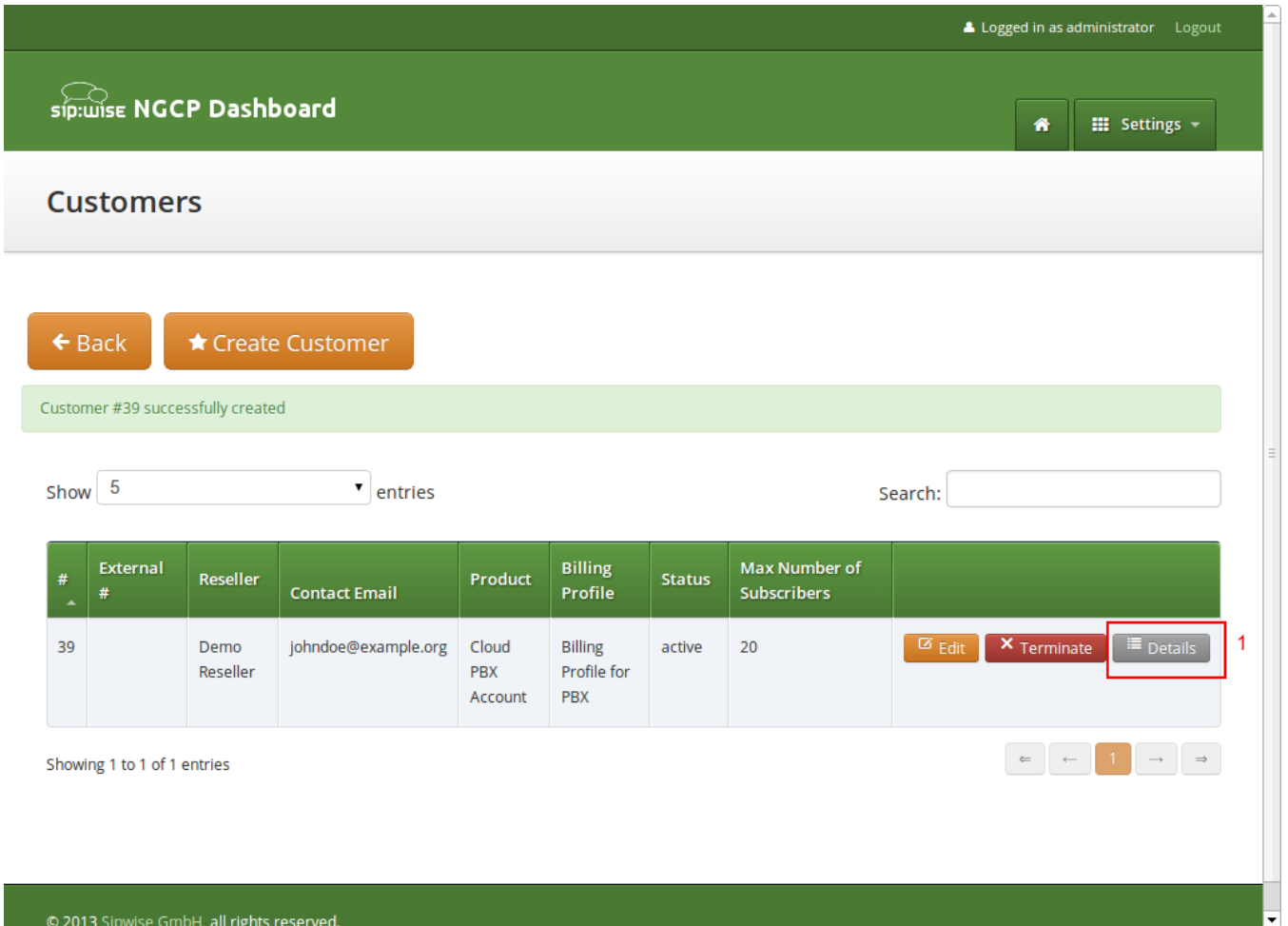

Figure 144. Go to Customer Details

To create the subscriber, open the *Subscribers* row and click *Create Subscriber*.

The screenshot shows the 'Customer Details for #39 (Cloud PBX Account)' page in the Sipwise NGCP Dashboard. The page is logged in as an administrator. The main content area features a sidebar with several menu items: 'Reseller', 'Contact Details', 'Billing Profiles', 'Subscribers', and 'Create Subscriber'. The 'Subscribers' item is highlighted with a red box and labeled with a '1'. The 'Create Subscriber' button is also highlighted with a red box and labeled with a '2'. Below the sidebar, there is a table with columns: 'SIP URI', 'Primary Number', 'PBX Group', and 'Registered Devices'. Other menu items like 'Sound Sets' and 'Contract Balance' are visible at the bottom of the sidebar.

Figure 145. Go to Create Subscriber

For your pilot subscriber, you need a SIP domain, a pilot number (the main number of the customer PBX), the web credentials for the customer to log into the web interfaces, and the SIP credentials to authenticate via a SIP device.

### IMPORTANT

In a PBX environment, customers can create their own subscribers. As a consequence, each PBX customer should have its own SIP domain, in order to not collide with subscribers created by other customers. This is important because two customers are highly likely to create a subscriber (or group, which is also only a subscriber) called office. If they are in the same SIP domain, they'd both have the SIP URI office@pbx.example.org, which is not allowed, and the end customer will probably not understand why office@pbx.example.org is already taken, because he (for obvious reasons, as it belongs to a different customer) will not see this subscriber in his subscribers list.

### TIP

To handle one domain per customer, you should create a wild-card entry into your DNS server like `*.pbx.example.org`, which points to the IP address of pbx.example.org, so you can define SIP domains like customer1.pbx.example.org or customer2.pbx.example.org without having to create a new DNS entry for each of them. For proper secure access to the web interface and to the SIP service, you should also obtain a SSL wild-card certificate for \*.pbx.example.org to avoid certification warnings on customers' web browsers and SIP clients.

So to create a new domain for the customer, click *Create Domain*.

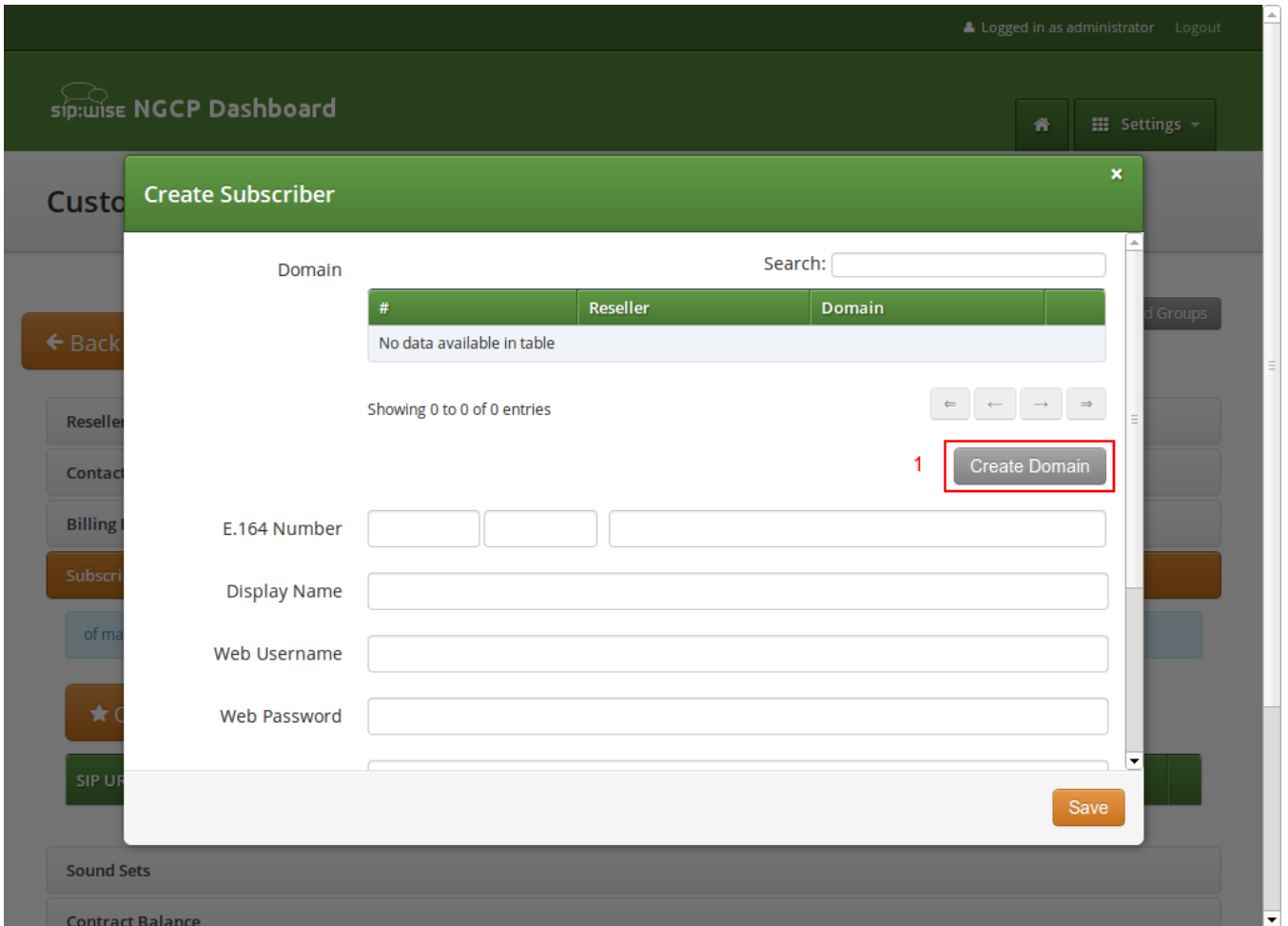

Figure 146. Go to Create Customer Domain

Specify the domain you want to create, and select the PBX *Rewrite Rule Set* which you created in [Preparing PBX Rewrite Rules](#), then click *Save*.

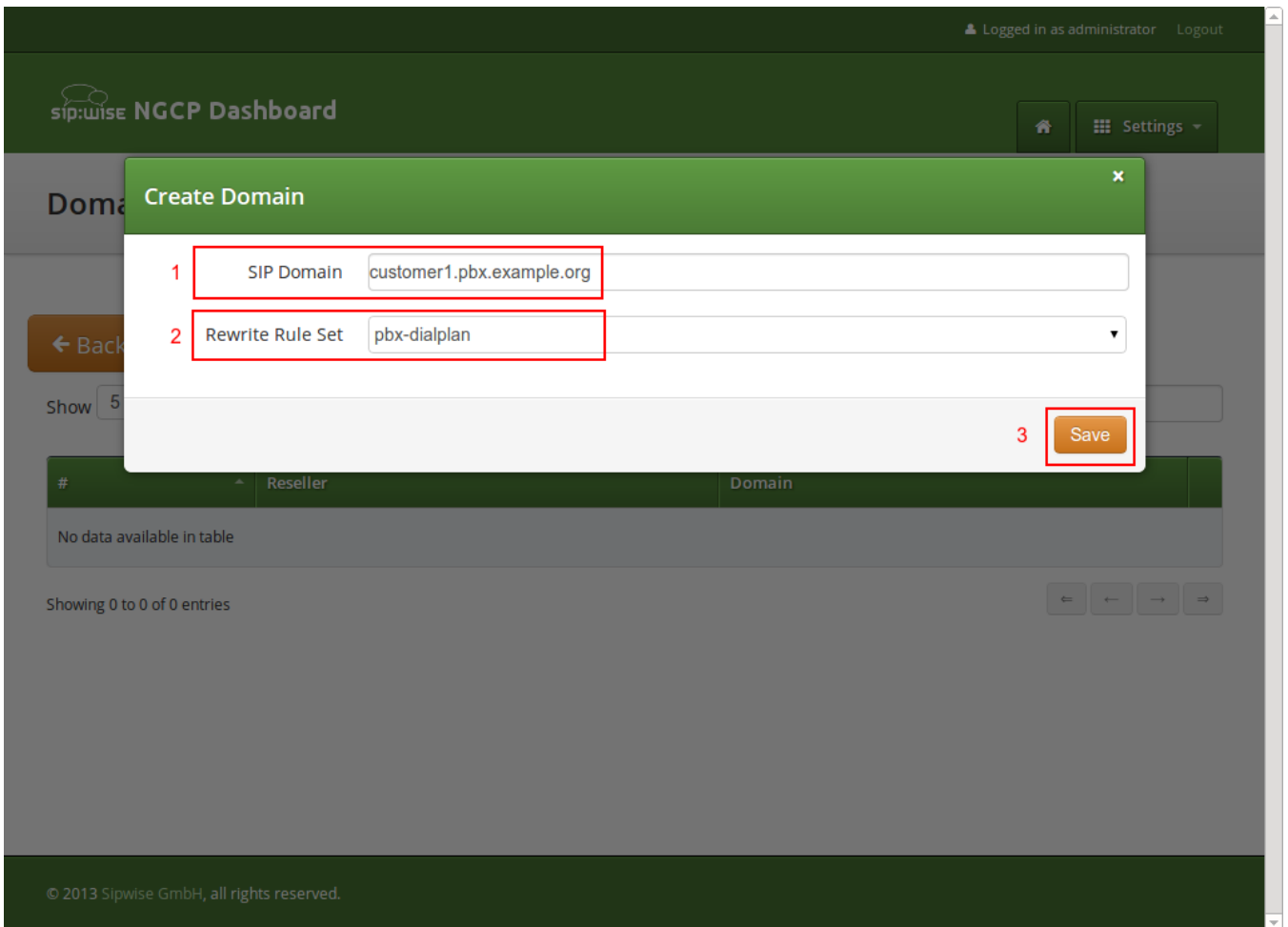

Figure 147. Create Customer Domain

Finish the subscriber creation by providing an E.164 number, which is going to be the base number for all other subscribers within this customer, the web username and password for the pilot subscriber to log into the web interface, and the sip username and password for a SIP device to connect to the PBX.

The parameters are as follows:

- **Domain:** The domain in which to create the pilot subscriber. *Each customer should get his own domain as described above to not collide with SIP usernames between customers.*
- **E.164 Number:** The primary number of the PBX. Calls to this number are routed to the pilot subscriber, and each subsequent subscriber created for this customer will use this number as its base number, suffixed by an individual extension. You can later assign alias numbers also for DID support.
- **Display Name:** This field is used on phones to identify subscribers by their real names instead of their number or extension. On outbound calls, the display name is signalled in the Display-Field of the From header.
- **Web Username:** The username for the subscriber to log into the customer self-care web interface. This is optional, if you don't want a subscriber to have access to the web interface.
- **Web Password:** The password for the subscriber to log into the customer self-care web interface.
- **SIP Username:** The username for the subscriber to authenticate on the SIP service. It is automatically used for devices, which are auto-provisioned via the *Device Management*, or can be

used manually by subscribers to sign into the SIP service with any arbitrary clients.

- **SIP Password:** The password for the subscriber to authenticate on the SIP service.

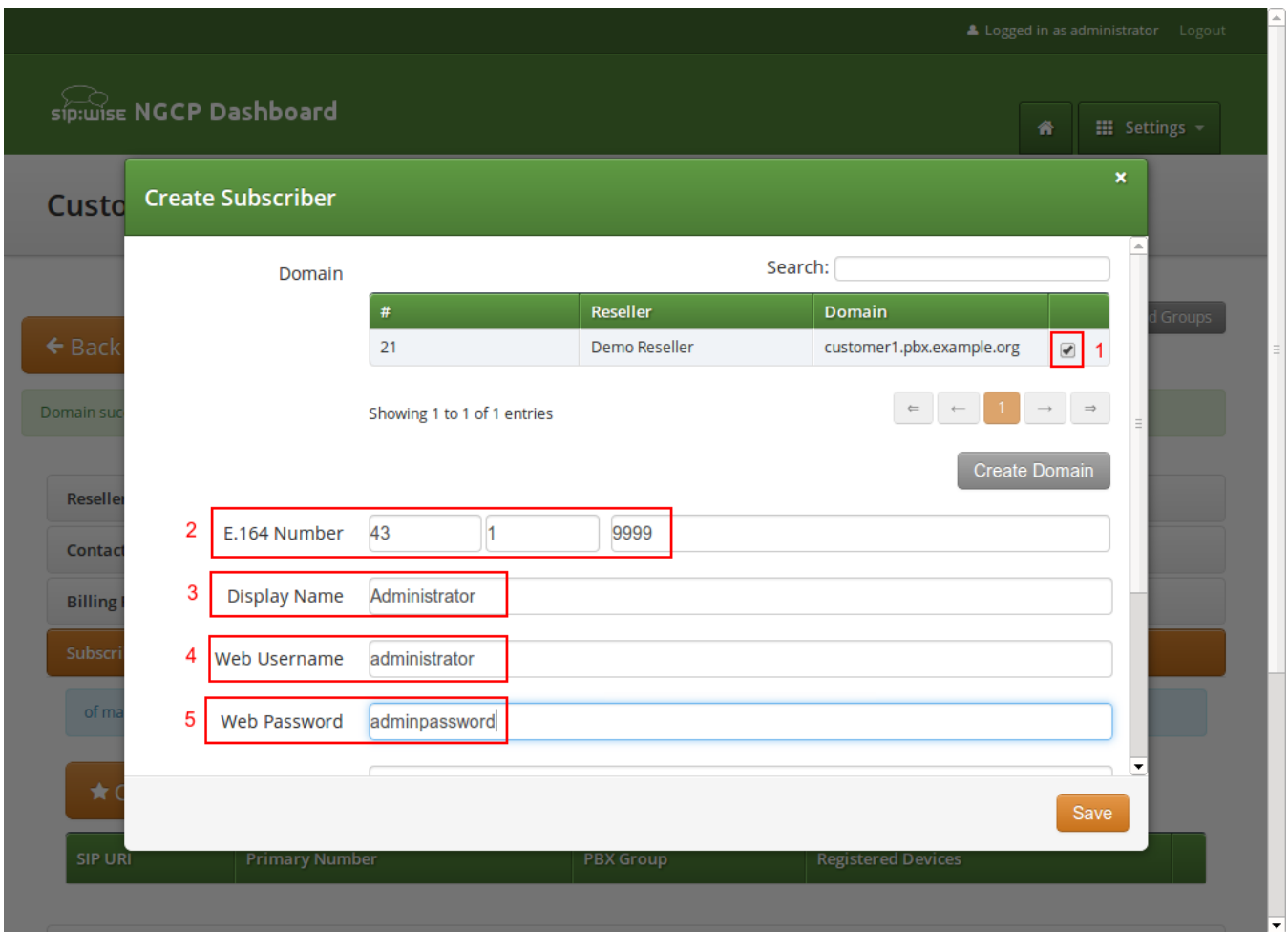

Figure 148. Create Pilot Subscriber Part 1

**Create Subscriber**

E.164 Number

Display Name

Web Username

Web Password

1  SIP Username

2  SIP Password

Status

External ID

3

Figure 149. Create Pilot Subscriber Part 2

Once the subscriber is created, he can log into the customer self-care interface at <https://<your-ip>/> and manage his PBX, like creating other users and groups, assigning Devices to subscribers and configure the Auto Attendant and more.

As an administrator, you can also do this for the customer, and we will walk through the typical steps as an administrator to configure the different features.

Go to the *Customer Details* of the PBX customer you want to configure, e.g. by navigating to *Settings Customers* and clicking the *Details* button of the customer you want to configure.

#### 8.1.4. Creating Regular PBX Subscribers

Since we already created a pilot subscriber, more settings now appear on the *Customer Details* view. The sections we are interested in for now are the *Subscribers* and *PBX Groups* sections.

Logged in as administrator Logout

sip:wise NGCP Dashboard

Home Settings

## Customer Details for #39 (Cloud PBX Account)

← Back Edit Expand Groups

- Reseller
- Contact Details
- Billing Profiles
- Subscribers
- PBX Groups
- PBX Devices
- Sound Sets
- Contract Balance
- Fraud Limits

Figure 150. Subscribers and PBX Groups

To create another subscriber for the customer PBX, open the *Subscribers* row and click *Create Subscriber*.

Customer Details for #39 (Cloud PBX Account)

← Back Edit Expand Groups

Reseller

Contact Details

Billing Profiles

1 Subscribers

1 of maximum 20 subscribers (including PBX groups) created

2 ★ Create Subscriber

SIP URI	Primary Number	PBX Group	Registered Devices
administrator@customer1.pbx.example.org	43 1 9999		

Figure 151. Create a Subscriber Extension

When creating another subscriber in the PBX after having the pilot subscriber, some fields are different now, because the *Domain* and *E.164 Number* are already pre-defined at the pilot subscriber level.

What you need to define for a new subscriber is the *Group* the subscriber is supposed to be in. We don't have a group yet, so create one by clicking *Create Group*.

A *PBX Group* has four settings:

- **Name:** The name of the group. This is used to identify a group when assigning it to subscribers.
- **Extension:** The extension of the group, which is appended to the primary number of the pilot subscriber, so you can actually call the group from the outside. If our pilot subscriber number is 43 1 9999 and the extension is 100, you can reach the group from the outside by dialing 43 1 9999 100. Since PBX Groups are actually normal subscribers in the system, you can assign *Alias Numbers* to it for DID later, e.g. 43 1 9998.
- **Hunting Policy:** If you call a group, then all members in this group are ringing based on the policy you choose. Serial Ringing causes each of the subscribers to be tried one after another, until one of them picks up or all subscribers are tried. Parallel Ringing causes all subscribers in the group to be tried in parallel. Note that a subscriber can have a call-forward configured to some external number (e.g. his mobile phone), which will work as well.
- **Hunting Timeout:** This value defines for how long to ring each member of a group.

**IMPORTANT** | From mr11.0.1, *Serial Hunting Timeout* becomes *Hunting Timeout* and defines the

ringing timeout of each member whatever is the group policy.

We will only fill in the *Name* and *Extension* for now, as the hunting policy can be changed later if needed. Click *Save* to create the group.

The screenshot shows the 'Create PBX Group' modal in the Sipwise NGCP Dashboard. The form contains the following fields:

- Name:** marketing (highlighted with a red box and the number 1)
- Extension:** 100 (highlighted with a red box and the number 2)
- Hunting Policy:** Serial Ringing (dropdown menu)
- Serial Hunting Timeout:** 10
- Save:** A button highlighted with a red box and the number 3.

The background shows a table with the following data:

SIP URI	Primary Number	PBX Group	Registered Devices
administrator@customer1.pb.example.org	43 1 9999		

Figure 152. Create a PBX Group

Once the group is created and selected, fill out the rest of the form as needed. Instead of the *E.164 Number*, you can now only choose the *Extension*, which is appended to the primary number of the pilot subscriber and is then used as primary number for this particular subscribers. Again, if your pilot number is 43 1 9999 and you choose extension 101 here, the number of this subscriber is going to be 43 1 9999 101. Also, you can again later assign more alias numbers (e.g. 43 1 9997) to this subscriber for DID.

The rest of the fields is as usual, with *Display Name* defining the real name of the user, *Web Username* and *Web Password* allowing the subscriber to log into the customer self-care interface, and the *SIP Username* and *SIP Password* to allow signing into the SIP service.

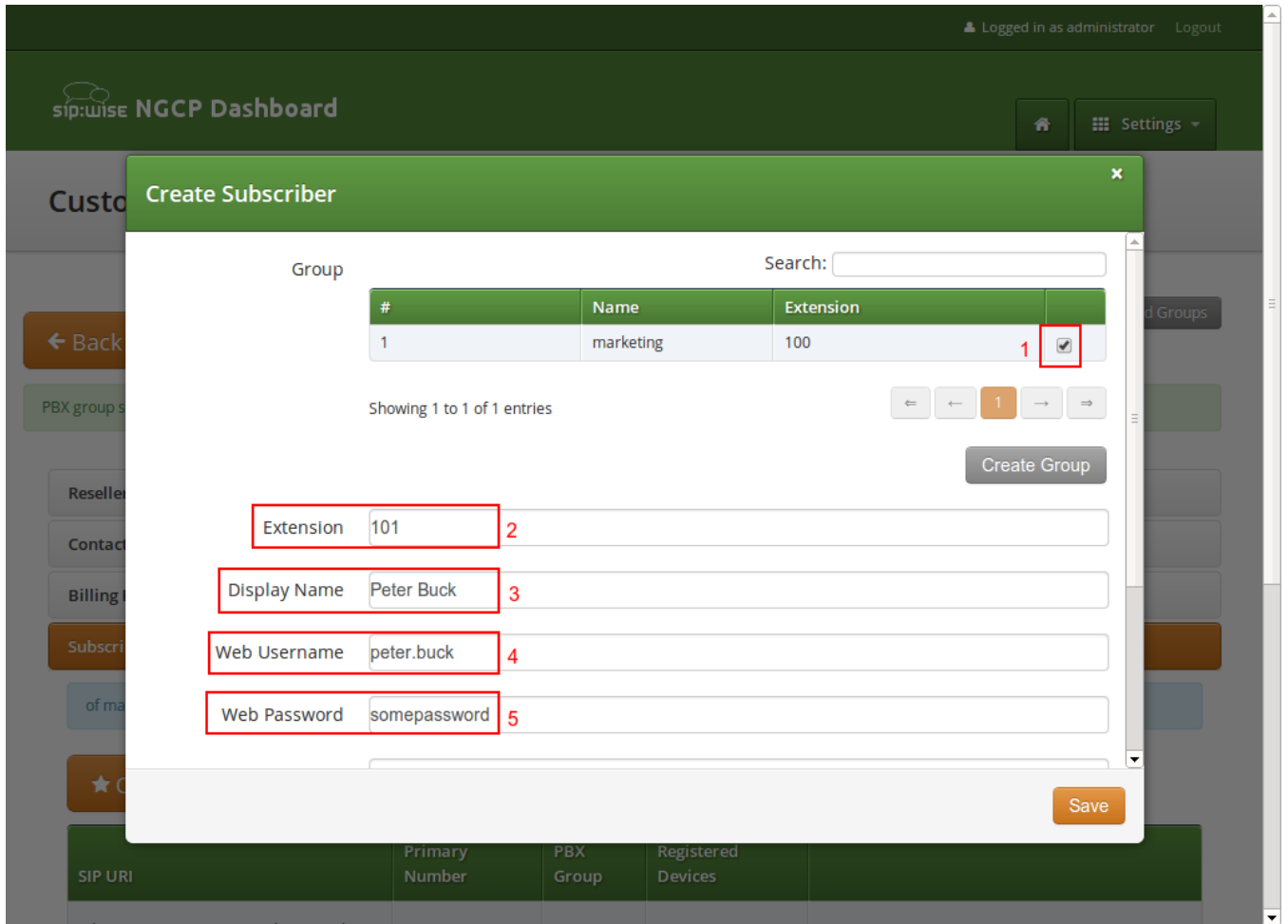

Figure 153. Finish PBX Subscriber Creation Part 1

Click Save to create the subscriber.

Customer Details for #39 (Cloud PBX Account)

← Back

Reseller

Contact

Billing

Subscri

of ma

★ C

SIP UP

admin

PBX Groups

### Create Subscriber

Extension

Display Name

Web Username

Web Password

SIP Username  1

SIP Password  2

Status

External ID

3

Figure 154. Finish PBX Subscriber Creation Part 2

Repeat the steps to create all the subscribers and groups as needed. An example of a small company configuration in terms of subscribers and groups might look like this:

Reseller

Contact Details

Billing Profiles

**Subscribers**

7 of maximum 20 subscribers (including PBX groups) created

★ Create Subscriber

SIP URI	Primary Number	PBX Group	Registered Devices
administrator@customer1.pbx.example.org	43 1 9999		
peter.buck@customer1.pbx.example.org	43 1 9999101	marketing	
michelle.miller@customer1.pbx.example.org	43 1 9999102	marketing	
frank.fowler@customer1.pbx.example.org	43 1 9999201	development	
deborah.dane@customer1.pbx.example.org	43 1 9999202	development	

PBX Groups

PBX Devices

Sound Sets

Figure 155. Example of Subscribers List

**TIP**

The subscribers can be reached via 3 different ways. First, you can call them by their SIP URIs (e.g. by dialing frank.fowler@customer1.pbx.example.org) from both inside and outside the PBX. Second, you can dial by the full number (e.g. 43 1 9999 201; depending on your rewrite rules, you might need to add a leading \+ or 00 or leave out the country code when dialing from the outside, and adding a 0 as break-out digit when dialing from the inside) from both inside and outside the PBX. Third, you can dial the extension (e.g. 201) from inside the PBX. If the subscriber also has an alias number assigned, you can dial that number also, according to your dial-plan in the rewrite rules.

### 8.1.5. Device/Aliases (how to register a phone on an alias)

Subscribers belonging to CloudPBX customers can create a special type of alias numbers called **Device/Alias**. Device/Alias differs in two important things compared to standard aliases:

- A device can register directly on a Device/Alias number. To do that configure the Device/Alias number on the authentication username of the device instead of using the sip username defined during the creation of the subscriber. The password to use is instead still the same.
- Devices registered directly on the alias number can make calls as devices registered using the subscribers' sip username. Incoming calls, instead, behave differently:

Incoming calls directed to the SIP Uri, to the full number, to the extension or to 'standard aliases' will let ring **ONLY** devices registered using the subscriber's sip username.

Incoming calls directed to Device/Aliases will let ring **ONLY** devices registered on that particular Device/Alias.

### How to create a Device/Alias

To create a Device/Alias proceed as for the creation of a standard alias but flag the *Is Device ID* option shown just under the *Alias Number* definition.

Edit Subscriber Master Data

E164 Number	43	1	9999
Alias Number	43	1	123456789
Is Device ID	<input checked="" type="checkbox"/>		

Remove

Add another number

Figure 156. Device/Alias Creation

To easily distinguish which is the type of alias associated to a subscriber, Device/Alias are reported with a handset logo just beside the number in the subscriber's master data.

Primary Number	43 1 9999202
Alias Numbers	43 1 123456789 📞 43 1 000000000
Extension	202

Figure 157. Show Device/Alias Master Data

#### IMPORTANT

Internal calls to Device/Aliases won't work in combination with [Extended matching inbound routing](#) user preference.

### lookup\_all\_registrations preference

The *lookup\_all\_registrations* subscriber's preference allows to modify the incoming call behaviour described above. In particular, if the preference is flagged the behaviour is modified as following:

- Incoming calls directed to the SIP Uri, to the full number, to the extension or to 'standard aliases' will let ring **BOTH** devices registered using the subscriber's sip username and devices registered on all the Device/Aliases.
- Incoming calls directed to Device/Aliases will continuous let ring **ONLY** devices registered on that particular Device/Alias.

### 8.1.6. Assigning Subscribers to a Device

You can register any SIP phone with the system using a SIP subscriber credentials. However, the platform supports *PBX Device Provisioning* of certain vendors and models, as described in [PBX Device Provisioning](#).

To configure a physical device, expand the *PBX Devices* section in the *Customer Details* page and click *Create Device*.

Set up three general parameters for the new device, which are:

- **Device Profile:** The actual device profile you want to use. This has been pre-configured in the *Device Management* by the administrator or reseller, and the customer can choose from the list of profiles (which is a combination of an actual device plus its corresponding configuration).
- **MAC Address/Identifier:** The MAC address of the phone to be added. The information can usually either be found on the back of the phone, or in the phone menu itself.
- **Station Name:** Since you can (depending on the actual device) configure more lines on a phone, you can give it a station name, like Reception or the name of the owner of the device.

In addition to that information, you can configure the lines (subscribers) you want to use on which key, and the mode of operation (e.g. if it's a normal private phone line, or if you want to monitor another subscriber using BLF, or if you want it to act as shared line using SLA).

For example, a *Cisco SPA504G* has 4 keys you can use for private and shared lines as well as BLF on the phone itself, and in our example we have an *Attendant Console* attached to it as well, so you have 32 more keys for BLF.

The settings per key are as follows:

- **Subscriber:** The subscriber to use (for private/shared lines) or to monitor (for BLF).
- **Line/Key:** The key where to configure this subscriber to.
- **Line/Key Type:** The mode of operation for this key, with the following options (depending on which options are enabled in the *Device Model* configuration for this device:

**Private Line:** Use the subscriber as a regular SIP phone line. This means that the phone will register the subscriber, and you can place and receive phone calls with/for this subscriber.

**Shared Line:** The subscriber is also registered on the system and you can place and receive calls. If another phone has the same subscriber also configured as shared line, both phones will ring on incoming calls, and you can pick the call up on either of them. You cannot place a call with this subscriber though if the line is already in use by another subscriber. However, you can "steal" a running call by pressing the key where the shared line is configured to barge into a running call. The other party (the other phone where the shared line is configured too) will then be removed from the call (but can steal the call back the same way).

**BLF Key:** The *Busy Lamp Field* monitors the call state of another subscriber and provides three different functionalities, depending on the actual state:

**Speed Dial:** If the monitored subscriber is on-hook, the user can press the button and directly call the monitored subscriber.

**Call Pickup:** If the monitored subscriber is ringing, the user can press the button to pick up the call on his own phone.

**State Indication:** If the monitored subscriber is on the phone, the key is indicating that the monitored subscriber is currently busy.

**Speeddial Key:** The key allows to call a predefined number.

**Forward Key:** The key allows to redirect and incoming call to a predefined number.

**Transfer Key:** The key allows to blind transfer and active call to a predefined number.

In our example, we will configure a private line on the first key, and the BLF for another subscriber on the second key.

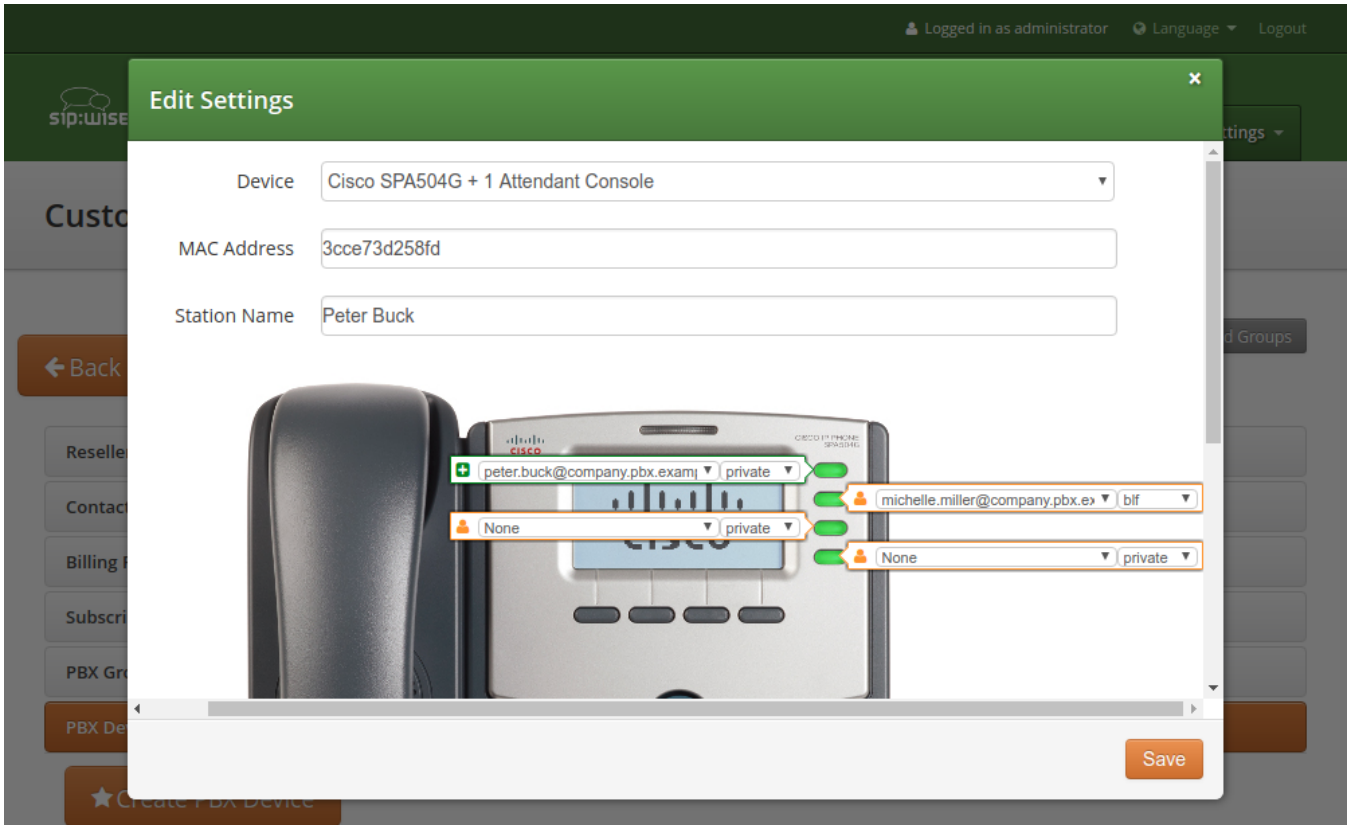

Figure 158. Configuring a PBX Device

Once the PBX device is saved, you will see it in the list of *PBX Devices*.

### Setting up a custom Speeddial / Forward / Transfer

In Admin UI, it is only possible to create a Speeddial / Forward / Transfer button with subscribers that are all in the same customer. If a Speeddial / Forward / Transfer with a custom number is required, setup using CSC is necessary.

Log in to CSC with a subscriber that has administrative privileges and navigate to PBX Configuration Devices. Click on the device where the Speeddial / Forward / Transfer button should be created. Then select the key where the button should be created

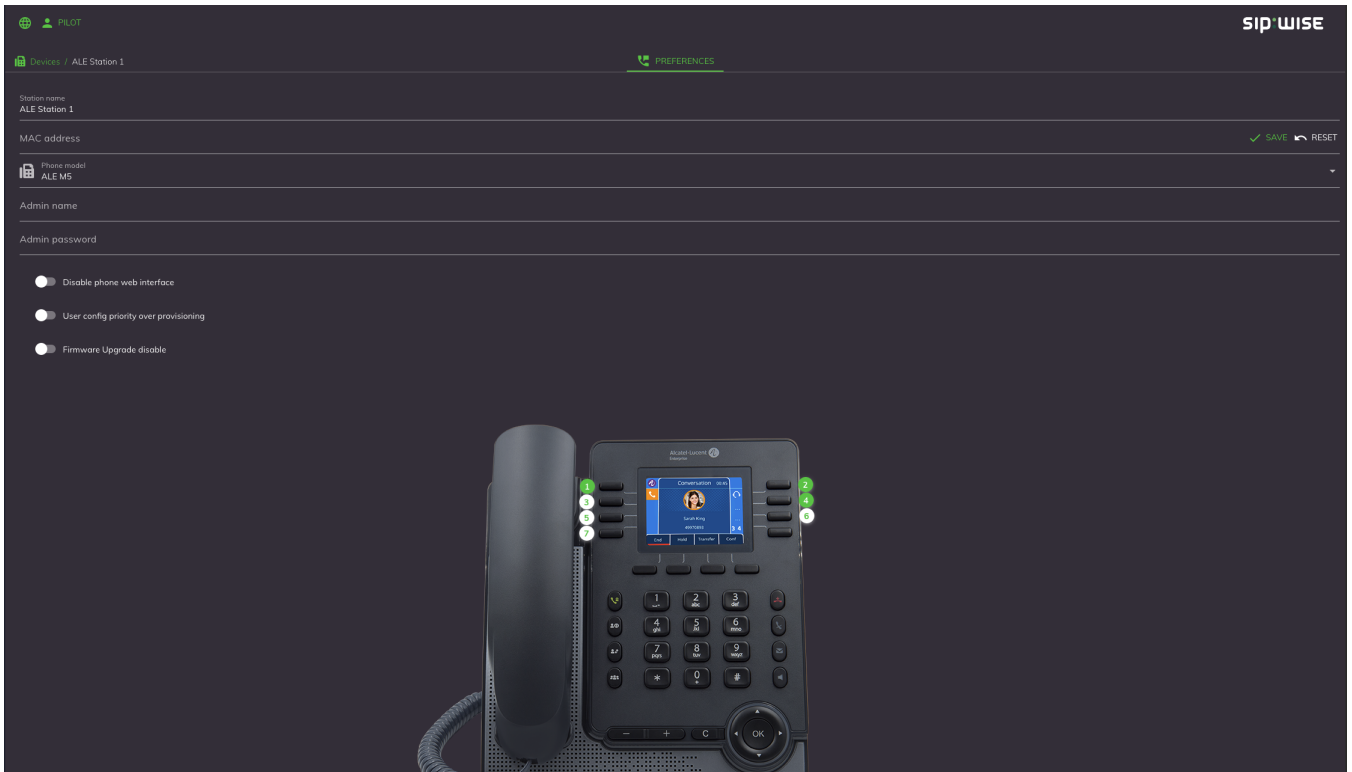

Figure 159. CSC device management page

Click on the toggle that says "Use custom number", enter the custom number and optionally a label. Afterwards click "Save"

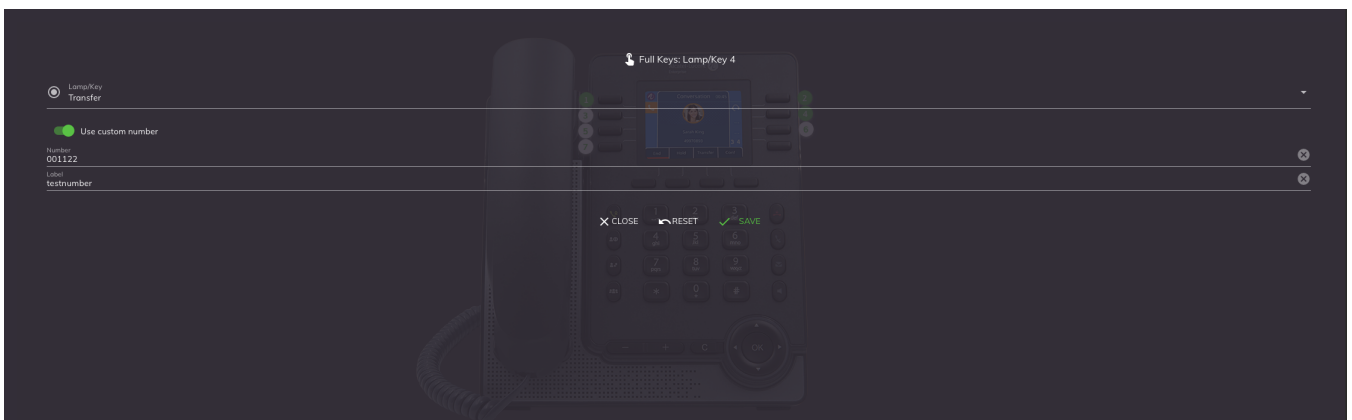

Figure 160. Button with custom number applied

### Initial provisioning of a PBX Device

Depending on a manufacturer and the model, there are two ways of provisioning a device:

- (legacy) putting the provisioning URL directly into the device via a web browser (this option is used e.g. for Cisco devices);
- (recommended) using the device's Zero Touch Provisioning (ZTP) feature. For Yealink it is called Redirection and Provisioning Service (RPS). Also available are Snom redirection and provisioning service (SRAPS) and Easy Deployment Server (EDS) from ALE.

## Direct device provisioning

Since a stock device obtained from an arbitrary distributor doesn't know anything about your system, it can't fetch its configuration from there. For that to work, you need to push the URL of where the phone can get the configuration to the phone once.

In order to do so, click the *Sync Device* button on the device you want to configure for the very first time.

The screenshot shows a web interface for managing PBX devices. At the top, there are several menu items: Contact Details, Billing Profile Schedule, Subscribers, PBX Groups, and PBX Devices (which is highlighted in orange). Below these is a 'Create PBX Device' button. The main part of the interface is a table with the following columns: Station Name, Subscriber, MAC Address / Identifier, and Device Profile. The first row of the table contains the following data:

Station Name	Subscriber	MAC Address / Identifier	Device Profile
Peter Buck	Phone Keys/0: private peter.buck@company.pbx.example.org Phone Keys/1: blf michelle.miller@company.pbx.example.org	3cce73d258fd	Cisco SPA504G + 1 Attendant Console

Below the table, there are four action buttons: Delete, Edit, Config, and Sync Device. The Sync Device button is highlighted with a red box.

Below the table, there are several menu items: Sound Sets, Contract Balance, Balance Intervals, and Top up Log.

Figure 161. Go to Sync Device

### IMPORTANT

As you will see in the next step, you need the actual IP address of the phone to push the provisioning URL onto it. That implies that you need access to the phone to get the IP, and that your browser is in the same network as the phone in order to be able to connect to it, in case the phone is behind NAT.

Enter the IP Address of the phone (on Cisco SPAs, press Settings 9, where Settings is the paper sheet symbol, and note down the Current IP setting), then click *Push Provisioning URL*.

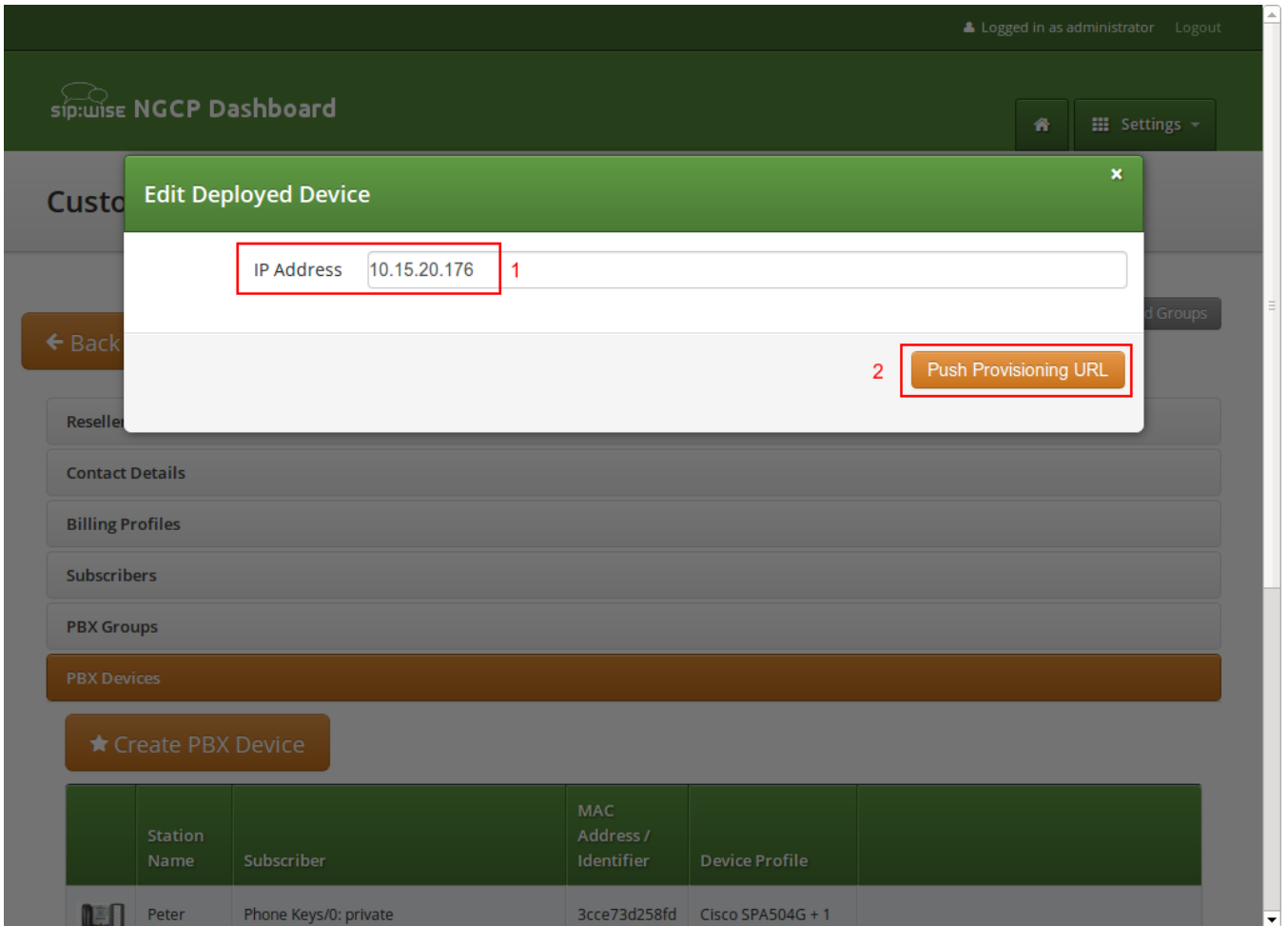



Figure 162. Sync Device

You will be redirected directly to the phone, and the Provisioning URL is automatically set. If everything goes right, you will see a confirmation page from the phone that it's going to reboot.



SPA will resync the profile when it is not in use and reboot.  
You can click [here](#) to return to the configuration page.

Figure 163. Device Sync Confirmation from Phone

You can close the browser window/tab and proceed to sync the next subscriber.

**TIP**

You only have to do this step once per phone to tell it the actual provisioning URL, where it can fetch the configuration from. From there, it will regularly sync with the server automatically to check for configuration changes and apply them automatically.

### Provisioning a device using ZTP/RPS/SRAPS/EDS

All ALE, Polycom, Panasonic, Snom, Grandstream and Yealink phones supported by Sipwise C5 can be provisioned using ZTP/RPS/SRAPS/EDS service without physically accessing the devices. You only need to input MAC addresses of corresponding devices and associate them with subscribers. Sipwise C5 will then immediately supply this information to the remote system of the corresponding device vendor. When a subscriber unpacks the phone and connects it to the Internet for the first time, the phone will contact the manufacturer's service and get its provisioning URL to Sipwise C5. Then, the phone downloads all required items from Sipwise C5 and automatically configures itself. Immediately after that, the subscriber can make the first call.

To prepare a PBX device for zero-touch provisioning, follow these steps:

- Go to the PBX Devices section of the corresponding customer and click *Create PBX Device*.
- Specify the device and its SIP lines parameters:

Select the required device model

Input the device MAC address

Specify the name of this line for your convenience

Select a subscriber from the list for the corresponding SIP line. Some devices support multiple lines and you can provision all of them at once.

Select the line type: *private*, *shared*, *BLF*, *speeddial*, *forwardor transfer*.

Add a text label, if required.

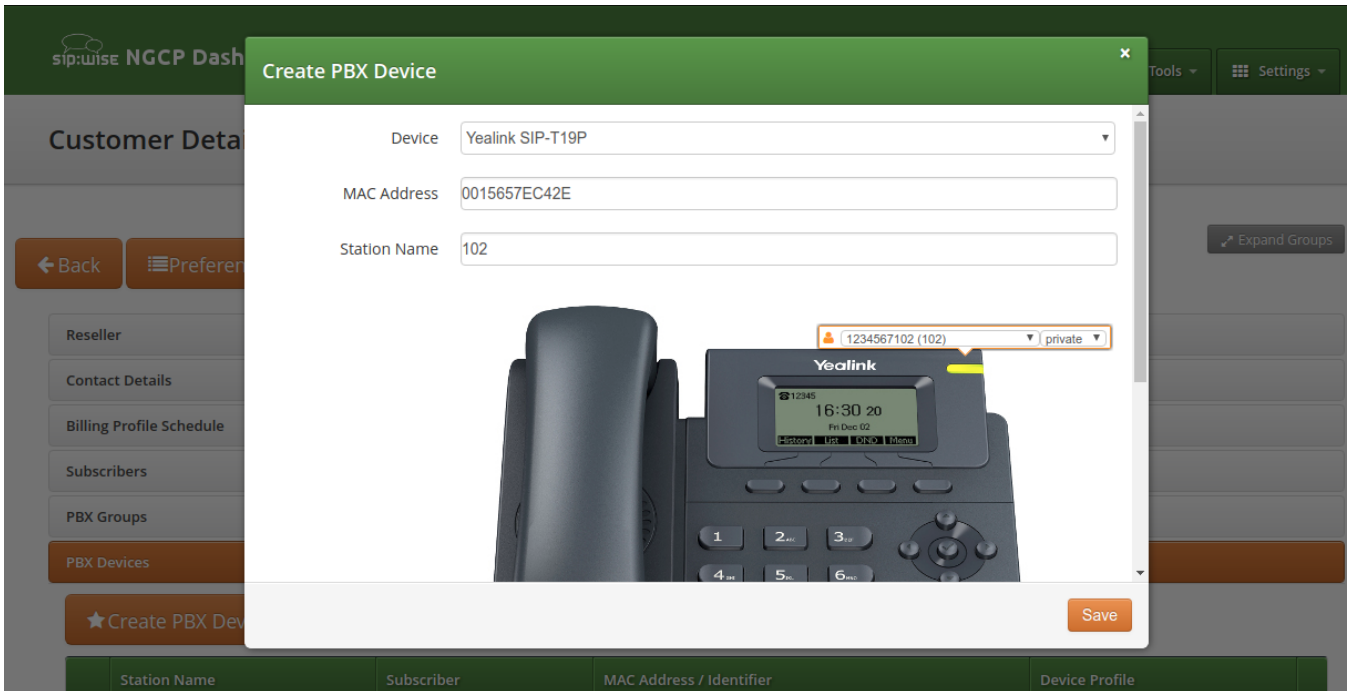

Figure 164. Create a PBX device

- Click **Save**. You will see the device in the list of customer's PBX devices.

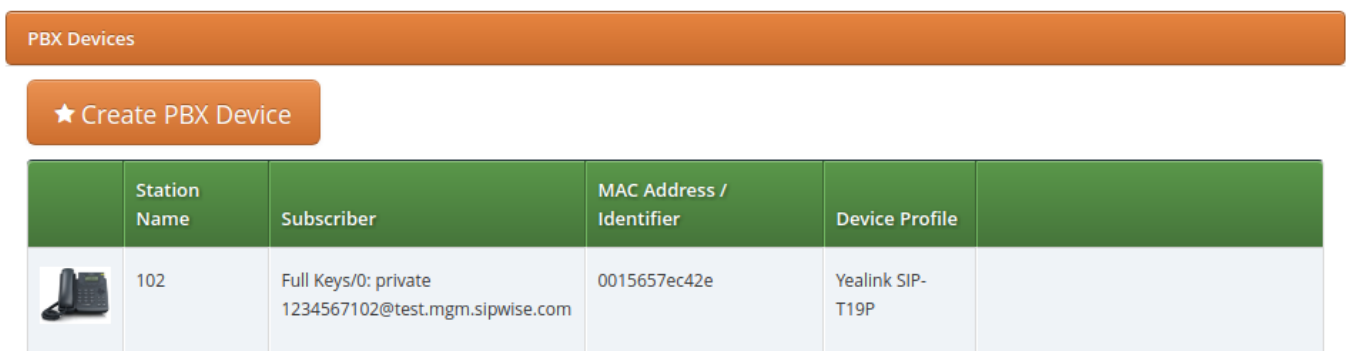

Figure 165. Created a new PBX device

#### TIP

If you have already provisioned a specific device on another platform or for another reseller, then you might need to delete that MAC address manually from the ZTP/RPS service (it is device vendor specific).

When the PBX device provisions itself, it will become registered with your SIP proxy server. From then, it will be listed in the subscriber's *Registered Devices* page.

Registered Devices				
★ Create Permanent Registration				
Search: <input type="text"/>				
#	User Agent	Contact	Expires	
191	Yealink SIP-T23 44.80.0.5	sip:1234567102@10.15.16.101:5060;line=058ea33e27ec720	2018-02-01 15:57:16	
Showing 1 to 1 of 1 entries				

Figure 166. Registered devices

If you need to troubleshoot the provisioning process, the following logs would help you:

- `/var/log/ngcp/nginx` (e.g. SSL errors are collected here: `autoprov_bootstrap_error.log` and `autoprov_error.log`)
- `/var/log/ngcp/panel-debug.log` (general provisioning logs)

**TIP**

In case you would like to edit a device model, firmware, configuration or profile, refer to [Adjusting the PBX Devices Configuration](#)

### 8.1.7. Configuring Sound Sets for the Customer PBX

In the *Customer Details* view, there is a row *Sound Sets*, where the customer can define his own sound sets for *Auto Attendant*, *Music on Hold* and the *Office Hours Announcement*.

To create a new sound set, open the *Sound Sets* row and click *Create Sound Set*.

If you do this as administrator or reseller, the *Reseller* and/or *Customer* is pre-selected, so keep it as is. If you do this as customer, you don't see any *Reseller* or *Customer* fields.

So the important settings are:

- **Name:** The name of the sound set as it will appear in the *Subscriber Preferences*, where you can assign the sound set to a subscriber.
- **Description:** A more detailed description of the sound set.
- **Expose to customer:** It doesn't have any influence on the *Contract Sound Sets*.
- **Default for Subscribers:** If this setting is enabled, then the sound set is automatically assigned to all already existing subscribers which do NOT have a sound set assigned yet, and also for all newly created subscribers.
- **Parent:** Select if this sound set has to inherit the announcements from another sound set. This allows to upload in the new sound set only the announcements that are different from the parent, saving disk spece.

Fill in the settings and click *Save*.

**Create Sound Set**

Name:

Description:

Expose to customer:

Default for Subscribers:

Parent:

#	Reseller	Name	Description	Parent	
33	default	SoundSet1	Grand Parent		<input type="checkbox"/>
41	default	SoundSet2	Parent	SoundSet1	<input type="checkbox"/>
43	default	SoundSet3	Child	SoundSet2	<input checked="" type="checkbox"/>

Showing 1 to 3 of 3 entries

Figure 167. Create Customer Sound Set

To upload files to your Sound Set, click the *Files* button for the Sound Set.

### Uploading a Music-on-Hold File

Open the *music\_on\_hold* row and click *Upload* on the *music\_on\_hold* entry. Choose a WAV file from your file system, and click the *Loopplay* setting if you want to play the file in a loop instead of only once. Click *Save* to upload the file.

**Edit music\_on\_hold**

Loopplay:

Use parent:

Soundfile:  music\_on\_hold.wav

Figure 168. Upload MoH Sound File

## 8.1.8. Auto-Attendant Function

The *Auto-Attendant* is a built-in IVR feature that is available to Cloud PBX subscribers. It provides an automatic voice menu that enables the caller to select from a number of destinations, which could be other PBX subscribers or groups.

Another typical use case for the *Auto-Attendant* function is when the customer would like to have an "office assistant" that automatically takes incoming calls and routes them to the desired extension (i.e. to a subscriber).

The *Auto-Attendant* offers 2 ways of selecting the final call destination:

- *option selection*: selecting one of the pre-configured destinations by pressing a single digit (0-9)
- *extension dialing*: entering an arbitrary PBX extension number directly

### Enabling the Auto-Attendant

The Auto-Attendant feature can be activated for any subscriber in the Customer PBX individually. There are three steps involved:

1. You have to prepare a *Sound Set* to have Auto-Attendant sound files.
2. You have to configure the destinations for the various options you provide (e.g. pressing 1 should go to the marketing subscriber, 2 to development and 3 to some external number).
3. You have to set a Call Forward to the Auto-Attendant.

To do so, go to *Customer Details* and in the *Subscribers* section, click the *Preferences* button of the subscriber, where the Auto-Attendant should be set.

### Preparing the Sound Set

Create a Sound Set and upload the Sound Files for it as described below. Afterwards in the *Subscriber Preferences* view, set the *Contract\_Sound\_Set* preference to the Sound Set to be used. To do so, click *Edit* on the *Contract\_Sound\_Set* preference and assign the set to be used.

### Uploading Auto-Attendant Sound Files

When configuring a Call Forward to the *Auto-Attendant*, it will play the following files:

- *aa\_welcome*: This is the welcome message (the greeting) which is played when someone calls the Auto-Attendant.
- each available pair of *aa\_X\_for/aa\_X\_option*: Each menu item in the Auto-Attendant consists of two parts. The for part, which plays something like *Press One for*, and the option part, which play something like *Marketing*. The Auto-Attendant only plays those menu options where both the for part and the option part is present, so if you only have 3 destinations you'd like to offer, and you want them to be on keys 1, 2 and 3, you have to upload files for *aa\_1\_for*, *aa\_1\_option*, *aa\_2\_for*, *aa\_2\_option* and *aa\_3\_for* and *aa\_3\_option*.

#### IMPORTANT

The sound files only define the general structure of what is being played to the caller. The actual destinations behind your options are configured separately in [Configuring the Auto-Attendant Slots](#).

An example configuration could look like this:

← Back Expand Groups

Sound handle successfully uploaded

music\_on\_hold

pbx

Name	Filename	Loop	
aa_welcome	welcome.wav	<input type="checkbox"/>	
aa_1_for	press-1.wav	<input type="checkbox"/>	
aa_1_option	for-sales.wav	<input type="checkbox"/>	
aa_2_for	press-2.wav	<input type="checkbox"/>	
aa_2_option	for-service.wav	<input type="checkbox"/>	
aa_3_for	press-3.wav	<input type="checkbox"/>	
aa_3_option	for-tech-support.wav	<input type="checkbox"/>	
aa_4_for		<input type="checkbox"/>	
aa_4_option		<input type="checkbox"/>	
aa_5_for		<input type="checkbox"/>	

Figure 169. Upload Auto-Attendant Options Sound Files

In order to activate the **extension dialing** function within the Auto-Attendant, you have to upload the following prompt files:

- aa\_star\_for, aa\_star\_option: the announcement "Press star for connecting to an extension" (or similar message, depending on customer's needs)
- aa\_enter\_extension: will instruct the caller to enter the phone number of the extension he wants to connect to
- aa\_invalid\_extension: will be played when the phone number entered does not match any of the customer's extensions

aa_8_option		<input type="checkbox"/>
aa_9_for		<input type="checkbox"/>
aa_9_option		<input type="checkbox"/>
aa_enter_extension		<input type="checkbox"/>
aa_invalid_extension		<input type="checkbox"/>
aa_star_for		<input type="checkbox"/>
aa_star_option		<input type="checkbox"/>
aa_welcome		<input type="checkbox"/>
office_hours		<input type="checkbox"/>
queue_full		<input type="checkbox"/>

Figure 170. Upload Auto-Attendant Extension Dialing Sound Files

In order to enable the Auto-Attendant to play a prompt when the caller hasn't selected any menu item within the timeout period, you have to upload a file to the "aa\_timeout" prompt in the "pbx" section of the Sound Set.

aa_star_for	aa_star_for.wav	<input type="checkbox"/>
aa_star_option	aa_star_option.wav	<input type="checkbox"/>
aa_timeout	xylofon.wav	<input type="checkbox"/>
aa_welcome	aa_welcome.wav	<input type="checkbox"/>
office_hours	office_hours.wav	<input type="checkbox"/>

Figure 171. Upload Auto-Attendant Timeout Sound File

### Auto-Attendant Flowchart with Voice Prompts

The illustration below shows the sequence of voice prompts played when Auto-Attendant feature is activated and a caller listens the IVR menu.

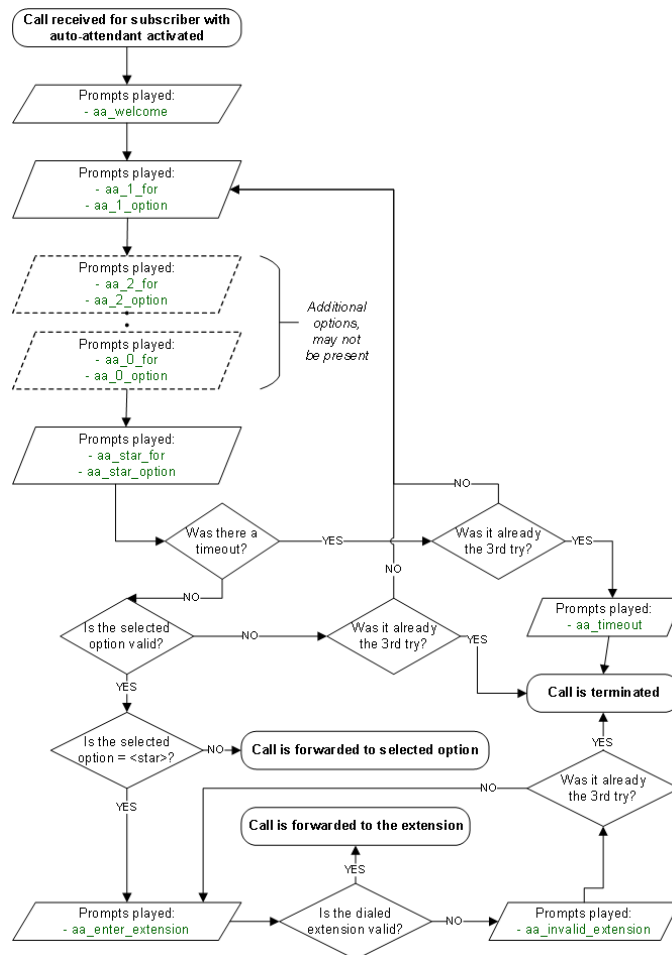

Figure 172. Flowchart of Auto-Attendant

## Configuring the Auto-Attendant repetitions

From the diagram above, you can see that if the auto attendant times out three times or if an invalid option is entered three times, the call is terminated.

The number of attempts (three) is configured in the `dsm.conf` file and applies globally. However, it is possible to set a different number of retries using the following preferences:

- `aa_timeout_repetition`
- `aa_wrongkey_repetition` These preferences, when applied to a subscriber with call forwarding to an AA service, can modify the number of times the system requests user interaction.

The first preference sets the number of retries for a "timeout" error. The second preference applies in case of an incorrect key selection. Note that setting these preferences to zero means "no repetition," so the AA messages are played only once. If an error occurs, the AA will terminate the call immediately.

## Configuring the Auto-Attendant Slots

In the *Auto-Attendant Slots* section, click the *Edit Slots* button to configure the destination options. There are up to 10 available slots to configure, from keys 0 to 9.

**TIP** | Be aware that only configured slots will be prompted in the Auto-Attendant menu.

Click *Add another Slot* to add a destination option, select the Key the destination should be assigned to, and enter a Destination. The destination can be a subscriber username (e.g. marketing), a full SIP URI (e.g. sip:michelle.miller@customer1.pbx.example.org or any external SIP URI) or a number or extension (e.g. 491234567 or 101).

Repeat the step for every option you want to add, then press *Save*.

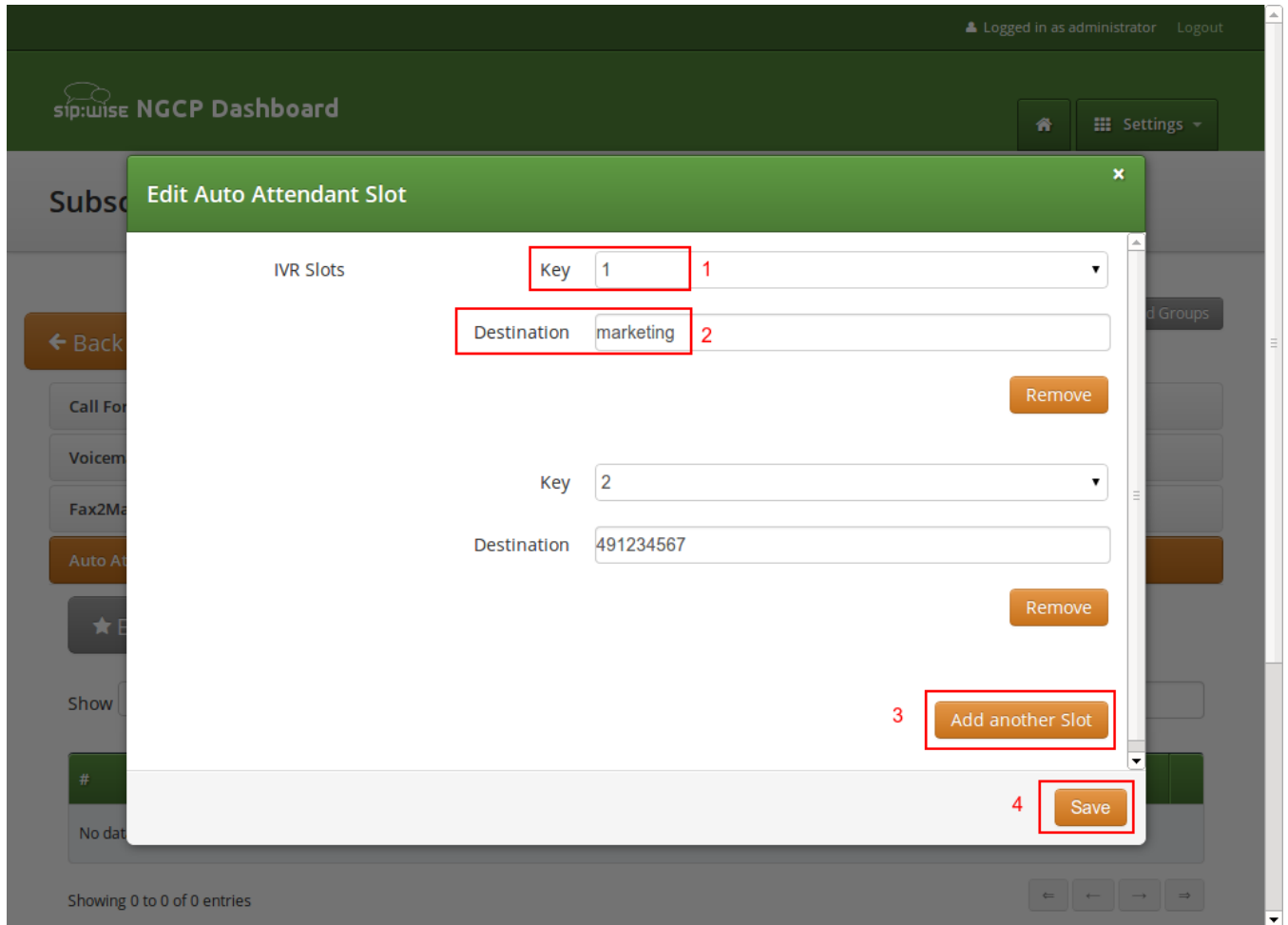

Figure 173. Define the Auto-Attendant Slots

#### TIP

You have a possibility to define the 'default' slot for cases when a caller doesn't pick out anything. Other than that, you can additionally set a sound file for this action.

### Activating the Auto-Attendant

Once the Sound Set and the Slots are configured, activate the Auto-Attendant by setting a Call Forward to Auto-Attendant.

To do so, open the *Call Forwards* section in the *Subscriber Preferences* view and press *Edit* on the Call Forward type (e.g. *Call Forward Unconditional* if you want to redirect callers unconditionally to the Auto-Attendant).

Select *Auto-Attendant* and click *Save* to activate the Auto-Attendant.

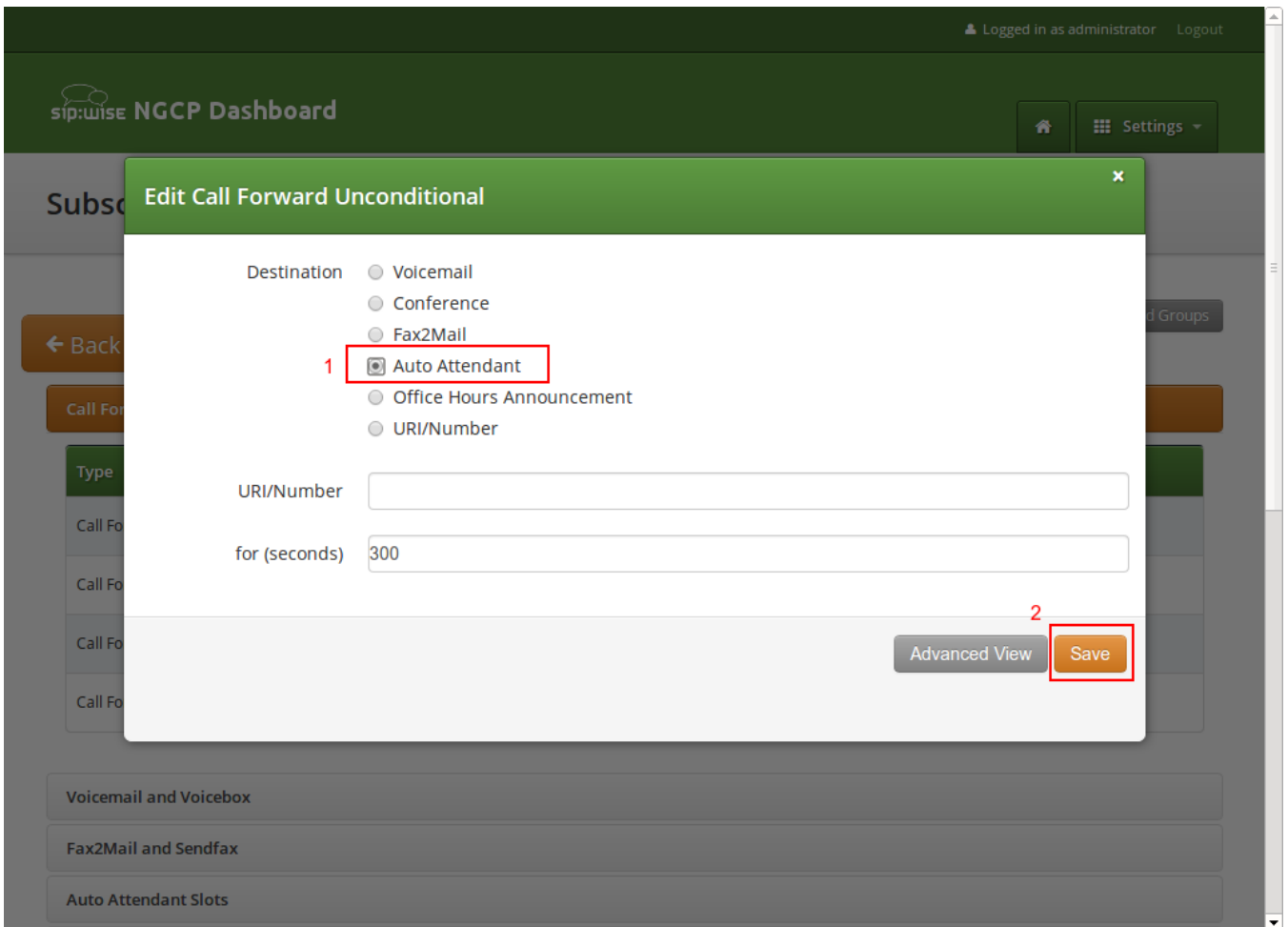

Figure 174. Set a Call Forward to Auto-Attendant

#### TIP

As with any other Call Forward, you can define more complex forwarding rules in the *Advanced View* to only forward the call to the Auto-Attendant during specific time periods, or as a fallback if no one picks up the office number.

### Handling input errors in the Auto-Attendant

If the caller enters an invalid menu item (0-9), i.e. a choice that hasn't got a valid destination or is not configured at all, the Auto-Attendant application will repeat the available choices again. The same happens when the caller enters an invalid extension number after selecting "star". After trying to select the wrong destination 3 times, the Auto-Attendant will terminate the call.

If the caller doesn't select any menu item for a pre-configured timeout, the Auto-Attendant will repeat the menu items again. When the caller doesn't select any menu item for 3 times, the Auto-Attendant will do the following:

- *terminate the call immediately* if the "aa\_timeout" prompt is not defined in the Sound Set
- *play the "aa\_timeout" prompt* before terminating the call, if that prompt is defined in the Sound Set, and then terminate the call

### 8.1.9. Cloud PBX Groups with Busy Members

A *huntgroup* (HG) or a *PBX Group* is a Cloud PBX feature that distributes the calls between members of

the group according to the configured hunt policy and timeout. The PBX group belongs to a customer and one Cloud PBX subscriber can be a member of one or more of the huntgroups of the customer. *Call Waiting* is a CPE (phone) feature that allows you to take another call while you're already on the phone.

Multiple incoming calls to the huntgroup may result in multiple calls delivered to the same subscriber if the Call Waiting feature is enabled on his phone, regardless whether the huntgroup members are busy at this time. Hence, busy subscribers may get a second incoming call. It may be an expected behavior (since one subscriber may have multiple devices and/or clients that all ring in parallel) or not, depending on the setup.

Therefore, Sipwise C5 Cloud PBX module offers *busy huntgroup member mode* feature to check the busy status of individual huntgroup members before routing a call to them. This will leave subscribers on active phone calls undisturbed by calls to huntgroup.

### IMPORTANT

From 10.4, *busy hunt group member mode* is the new name for what used to be previously named *Ignore Busy Hunt Group Members*. Not only the name is changed, but the configuration is also moved from the main configuration file: `/etc/ngcp-config/config.yml` to the domain preferences or to the subscriber preferences as described below. This evolution offers more flexibility in the configuration allowing to change the behavior on subscriber basis instead of system wide. The 10.4 upgrade procedure automatically migrates the `config.yml` setting to all your domains preferences.

The configuration of the *busy huntgroup member mode* feature is done via the `busy_hg_member_mode` parameter available at domain or subscriber preferences:

Cloud PBX				
	Attribute	Name	Value	
	<code>ignore_cf_when_hunting</code>	Ignore Call Forward when Hunting	<input type="checkbox"/>	
	<code>busy_hg_member_mode</code>	Busy huntgroup member mode	ring	

Figure 175. Busy huntgroup member mode configuration for domain

Cloud PBX				
	Attribute	Name	Value	
?	enable_t38	Enable T38 Fax-over-IP	<input type="checkbox"/>	
?	cloud_pbx_callqueue	PBX Call Queue	<input type="checkbox"/>	
?	max_queue_length	Call Queue length		
?	queue_wrap_up_time	Call Queue wrap-up time, sec		
?	csta_controller	CSTA Controller	<input type="checkbox"/>	
?	csta_client	CSTA Client	<input type="checkbox"/>	
?	busy_hg_member_mode	Busy huntgroup member mode	skip based on totaluser	

Figure 176. Busy huntgroup member mode configuration for subscriber

The `busy_hg_member_mode` preference may take the following values:

- **ring** (default value): A hunt group member is alerted of all incoming calls to his groups, regardless of his busy state.
- **skip\_totaluser**: A hunt group member is not alerted of incoming calls to his groups because he is busy for the following reasons (call distribution continues with other available huntgroup members):
  - he is involved in one or more incoming or outgoing calls in alerting or active phase
  - an incoming call intended for him has been forwarded to another destination and this call is in alerting or active phase.
- **skip\_activeuser**: A hunt group member is not alerted of incoming calls to his groups because he is involved in one or more incoming or outgoing calls in alerting or active phase but NOT busy for the calls that have been forwarded (call distribution continues with other available huntgroup members).
- **use domain default** (subscriber prefs. only): use the setting of the domain preference `busy_hg_member_mode`.

### IMPORTANT

This feature does not present an extended server-side Call Waiting functionality. It concerns only the huntgroups' behavior. Hence subscriber would still be able to receive multiple calls when called directly (not via huntgroup) with Call Waiting enabled on his phone.

As an example, if the `busy_hg_member_mode` preference is set to `skip_totaluser`, a huntgroup call will not be distributed to a subscriber in the following situations:

#### Use Case 1

Subscriber receives an incoming call. A second call is made to the HG. The subscriber should NOT receive this call via HG extension.

### Use Case 2

Subscriber makes an outgoing call. A second call is made to the HG. The subscriber should NOT receive this call via HG extension.

### Use Case 3

Subscriber with a call forward enable (CFU, CFB, CFNA, CFT) receives a call to his extension (not extension of HG) which is then forwarded. A second call is made to the HG. The subscriber should NOT receive the call via HG extension.

In order to prevent the forwarded calls from keeping the subscriber as "busy" for the purpose of this feature the platform administrator should set the domain or the subscriber preference `busy_hg_member_mode` to the value `skip_activeuser`:

While User Cases 1 and 2 will behave in the same way as described above, the change of behavior happens in Use Case 3:

### Use Case 3

Subscriber with a call forward enabled (CFU, CFB, CFNA, CFT) receives a call to his extension (not extension of HG) which is then forwarded. A second call is made to the HG. The subscriber should receive the call as normal.

## 8.1.10. Configuring Call Queues

The Sipwise C5 platform offers call queueing feature for Cloud PBX subscribers. For any subscriber within the PBX, the Sipwise C5 system administrator or the subscriber themselves may activate the Call Queue.

If call queue activation has been done and the subscriber receives more than 1 call at a time, then the second and all further callers will be queued until the subscriber finishes their call with the first caller and is available.

### Activating the Call Queue

The call queue configuration is available at the path: *Subscribers press the three dots Preferences Cloud PBX*.

Following configuration parameters may be set for call queueing:

- `cloud_pbx_callqueue` : shows the status of call queueing (enabled / disabled); by default it is disabled
- `max_queue_length` : the length of call queue, i.e. the maximum number of callers in a queue; the default is 5
- `queue_wrap_up_time` : the delay in seconds between the ending of the previous call and the connection of the next queued caller with the subscriber; the default is 10

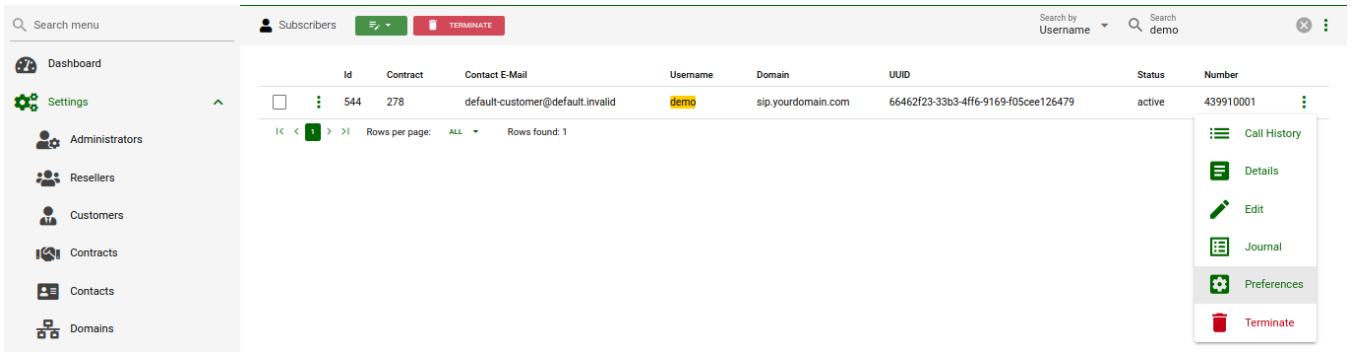

Figure 177. Subscribers Preferences

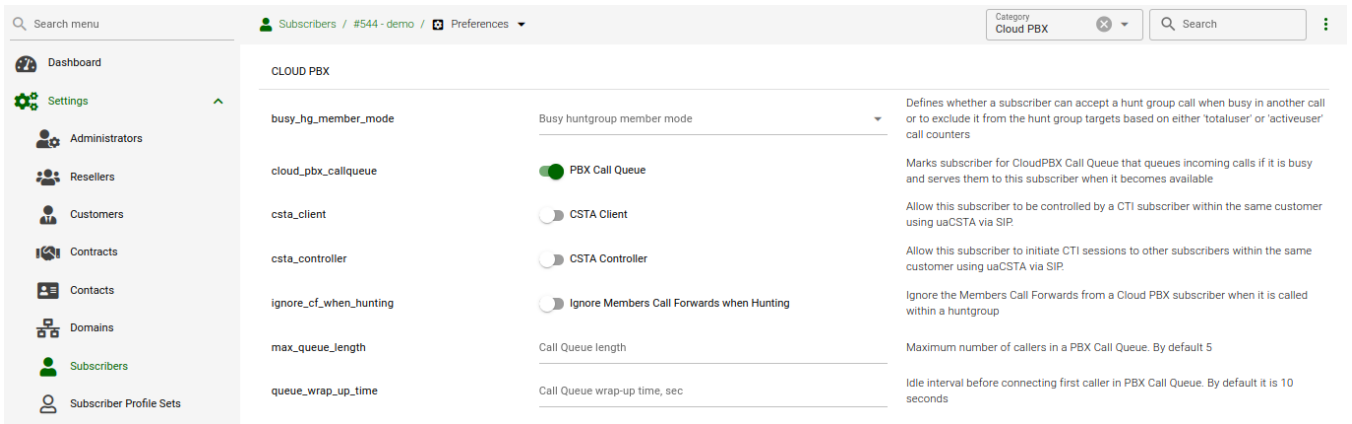

Figure 178. Call Queue Preferences

## Call Queue Voice Prompts

Queued callers first hear a greeting message then information about their position in the queue and finally a waiting music / signal.

Table 36. Call Queue Voice Prompts

Prompt handle	Prompt content
<code>queue_greeting</code>	All lines are busy at the moment, you are being queued.
<code>queue_prefix</code>	You are currently number...
<code>queue_suffix</code>	... in the queue, please hold the line.
<code>queue_full</code>	All lines are busy at the moment, please try again later.
<code>queue_waiting_music</code>	<waiting music>

## Call Queue Flowchart with Voice Prompts

The following illustration shows which voice prompts are played to the caller when the call gets into a queue.

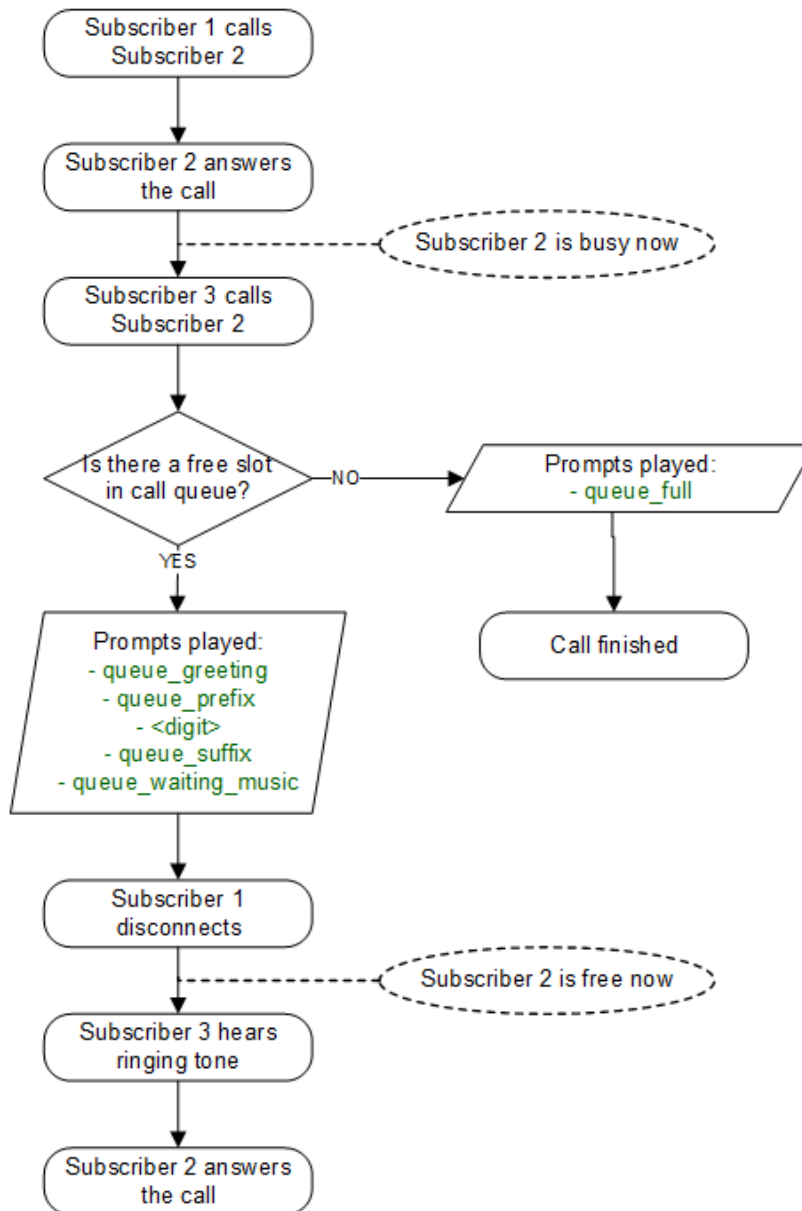

Figure 179. Flowchart of Call Queue

### 8.1.11. Device Auto-Provisioning Security

#### Server Certificate Authentication

Cisco SPA phones can connect to the provisioning interface of the PBX via HTTP and HTTPS. When performing secure provisioning over HTTPS, the phones validate the server certificate to check if its a legitimate Cisco provisioning server. To pass this check, the provisioning interface must provide a certificate signed by Cisco for that exact purpose.

The following steps describe how to obtain such a certificate.

First, a new SSL key needs to be generated:

```
$ openssl genrsa -out provisioning.key 2048
Generating RSA private key, 2048 bit long modulus
```

```
...+++
.....+++
e is 65537 (0x10001)
```

Next, a certificate signing request needs to be generated as follows. Provide your company details.

**IMPORTANT**

The **Common Name (e.g. server FQDN or YOUR name)** field is crucial here. Provide an FQDN which the phones will later use via DNS to connect to the provisioning interface, for example *pbx.example.org*. Cisco does **NOT** support wild-card certificates.

**IMPORTANT**

Leave the password empty when asked for it (press Enter without entering anything).

```
$ openssl req -new -key provisioning.key -out provisioning.csr
You are about to be asked to enter information that will be incorporated
into your certificate request.
What you are about to enter is what is called a Distinguished Name or a
DN.
There are quite a few fields but you can leave some blank
For some fields there will be a default value,
If you enter '.', the field will be left blank.
```

```
Country Name (2 letter code) [AU]:AT
State or Province Name (full name) [Some-State]:Vienna
Locality Name (eg, city) []:Vienna
Organization Name (eg, company) [Internet Widgits Pty Ltd]:Sipwise GmbH
Organizational Unit Name (eg, section) []:Operations
Common Name (e.g. server FQDN or YOUR name) []:pbx.example.org
Email Address []:office@sipwise.com
```

```
Please enter the following 'extra' attributes
to be sent with your certificate request
A challenge password []:
An optional company name []:
```

Finally, compress the provisioning.csr file via ZIP and send it to our Cisco sales representative. If in doubt, you can try to send it directly to [ciscosb-certadmin@cisco.com](mailto:ciscosb-certadmin@cisco.com) asking them to sign it.

**IMPORTANT**

Please submit only the CSR file. **Do NOT submit the key file, as it contains your private key.**

**IMPORTANT**

Ask for both the signed certificate AND a *combinedca.crt* which is needed to perform client authentication via SSL. Otherwise you cannot restrict access to Cisco SPAs only.

You will receive a signed CRT file, which Sipwise can use to configure the PBX provisioning interface.

## Client Certificate Authentication

If a client connects via HTTPS, the server also checks for the client certificate in order to validate that the device requesting the configuration is indeed a legitimate Cisco phone, and not a fraudulent user with a browser trying to fetch user credentials.

Cisco Client Root Certificate can be obtained from [Download Client Certificates](#) website.

### 8.1.12. Device Bootstrap and Resync Workflows

The IP phones supported by the PBX need to initially be configured to fetch their configuration from the system. Since the phones have no initial information about the system and its provisioning URL, they need to be boot-strapped. Furthermore, changes for a specific device might have to be pushed to the device immediately instead of waiting for it to re-fetch the configuration automatically.

The following sections describe the work-flows how this is accomplished without having the customer directly accessing the phone.

#### ALE Device Bootstrap

##### *Initial Bootstrapping*

ALE provides a zero-touch provisioning mechanism in their firmware, which causes the factory-reset phones to connect to the [ALE website](#) to check if a custom provisioning URL is configured for the MAC address of the phone. If an association between the MAC and a provisioning URL is found, the web service redirects the phone to the provisioning URL, where the phone connects to in order to obtain the configuration file.

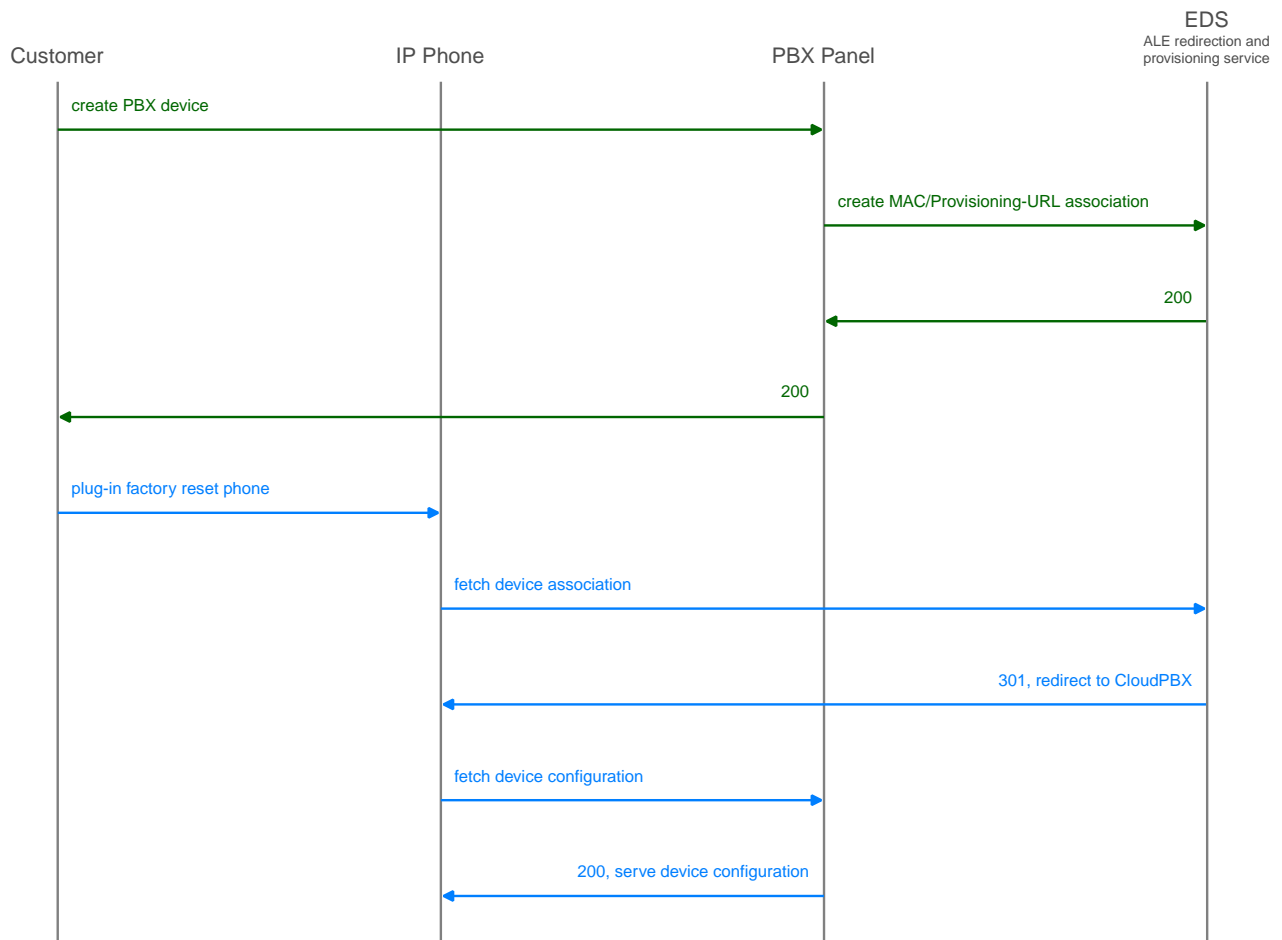

Figure 180. Initially bootstrap an ALE phone

The CloudPBX module ensures that when an end customer creates an ALE device, the MAC address is automatically provisioned on the ALE web service via an API call, so the customer's phone can use the correct provisioning URL to connect to the auto-provisioning server of the CloudPBX.

As a result, no customer interaction is required to bootstrap ALE phones, other than just creating the phone with the proper MAC on the CloudPBX web interface.

### Updating ALE Firmware

#### For Myriad Devices:

NGCP provides version 2.13.01.000.1899 by default, but also offers versions 2.12.04.1729 and 2.11.01.1604. If another firmware version is needed, these can be downloaded at <https://www.aledevice.com/site/download> and manually uploaded to NGCP

#### IMPORTANT

If firmware older than 2.11.01.1604 is used, direct upgrades to the latest firmware can no longer be guaranteed. To prevent this, upgrade phones manually to version 2.11.01.1604 or newer

#### IMPORTANT

If firmware older than 2.13.01.000.1899 is used, position of accounts set in NGCP will no longer align with the phone display. To prevent this, upgrade phones to version 2.13.01.000.1899 or newer

**For Halo Devices:** NGCP provides version 2.12.05.000.1194 for devices H3G and H6 and version

2.10.00.0001078 for device H2P. If another firmware version is needed, these can be downloaded at <https://www.aledevice.com/site/download> and manually uploaded to NGCP

**For Cloud Edition series devices:** NGCP provides version 1.53.37.4117 for all Cloud Edition devices. If another firmware version is needed, these can be downloaded at <https://www.aledevice.com/site/download> and manually uploaded to NGCP

### **Factory Reset**

For already provisioned phones, the end customer might need to perform a factory reset.

On Myriad, H3G and H6 phones, holding down the conference button for 10 seconds will give you the option to reset the device.

On H2P phone, holding down the "OK" button for 8 seconds will give you the option to reset the device

On Cloud Edition phones, following steps need to be done.

- Start up the phone
- When the boot up screen shows up, during step 1 press keys 1, 3, 7, and 9 at the same time
- Input **46\*46\*253** and the phone should reset

The default keypad password is 0000. The WEB username for factory-reset phones is *admin* with password 123456.

See more details here: [ALE FAQ](#).

### **Bootstrap URL**

The default ALE bootstrap URI is: `http://<ngcp.fqdn>:1445/device/autoprov/bootstrap/{mac}` You can find the URI above on EDS WEB interface for newly provisioned ALE devices. The variable "{mac}" will expand to the device MAC address automatically on ALE device before connecting to NGCP. You can change the default "Bootstrap URI" on page "Edit Device Model". See more details in [PBX bootstrap, firmwares and security](#).

#### **NOTE**

We strongly recommended using a secure bootstrap config:  
`https://<ngcp.fqdn>:1444/device/autoprov/config/{mac}`

### **Cisco SPA Device Bootstrap**

#### **Initial Bootstrapping**

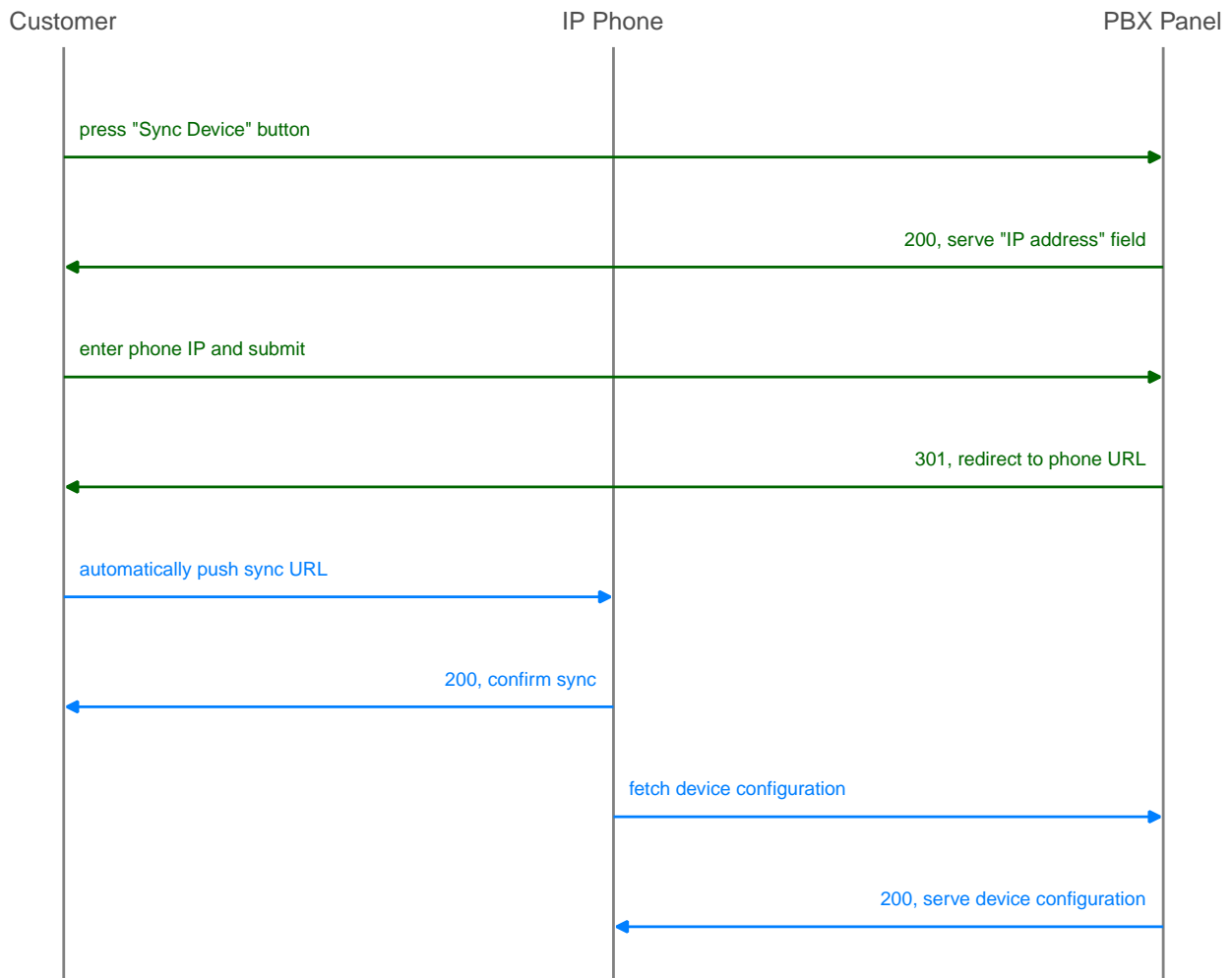

Figure 181. Initially bootstrap a PBX device

### Subsequent Device Resyncs

If one of the subscribers configured on a PBX device is registered via SIP, the system can trigger a re-sync of the phone directly via SIP without having the customer enter the IP of the phone again. This is accomplished by sending a special **NOTIFY** message to the subscriber:

```

NOTIFY sip:subscriber@domain SIP/2.0
To: <sip:subscriber@domain>
From: <sip:subscriber@domain>;tag=some-random-tag
Call-ID: some-random-call-id
CSeq: 1 NOTIFY
Subscription-State: active
Event: check-sync
Content-Length: 0
  
```

In order to prevent unauthorized re-syncs, the IP phone challenges the request with its own SIP credentials, so the NOTIFY is sent twice, once without authentication, and the second time with the subscriber's own SIP credentials.

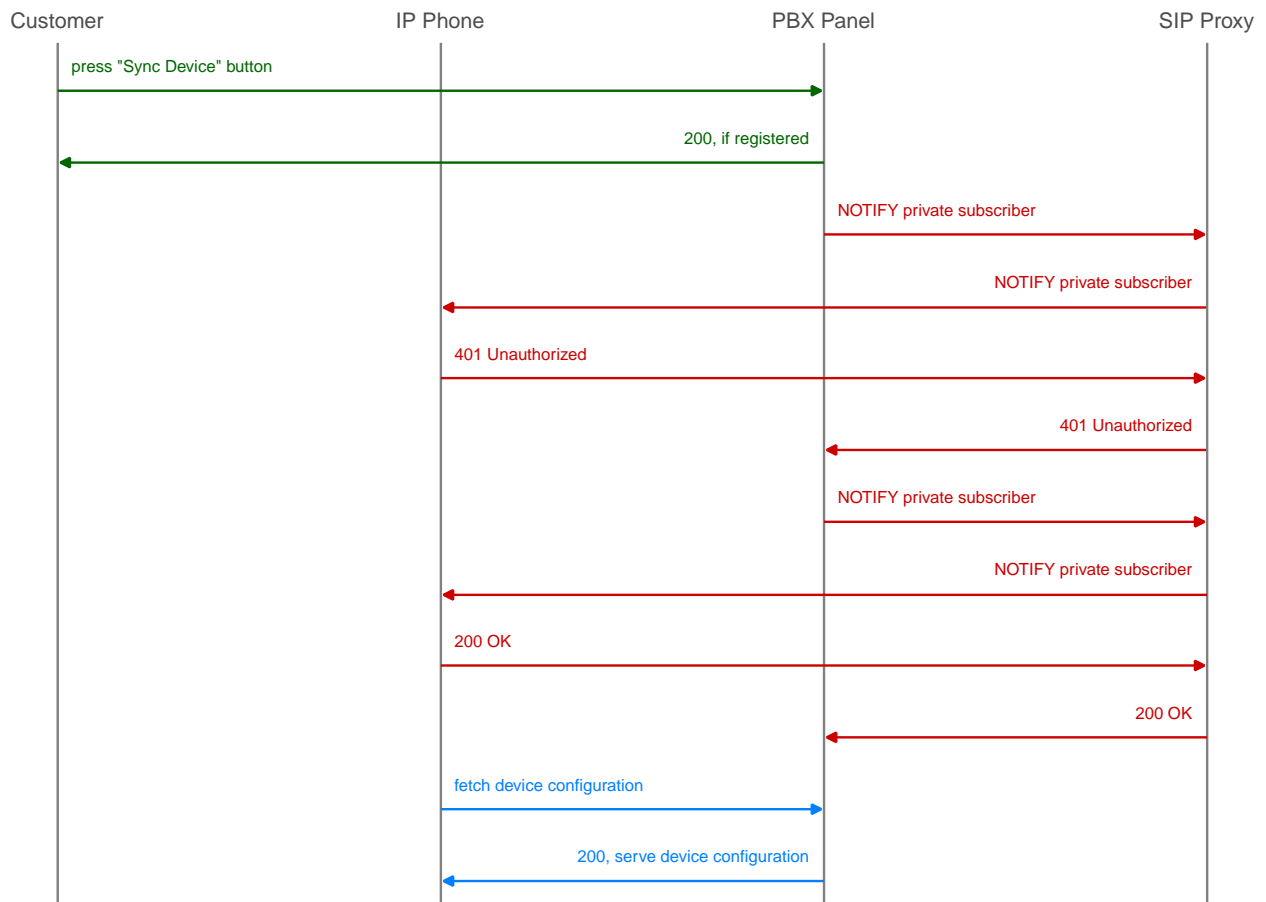

Figure 182. Resync a registered PBX device

## Panasonic Device Bootstrap

### Initial Bootstrapping

to connect to a Panasonic web service at <https://provisioning.e-connecting.net> to check if a custom provisioning URL is configured for the MAC address of the phone. If an association between the MAC and a provisioning URL is found, the web service redirects the phone to the provisioning URL, where the phone connects to in order to obtain the configuration file. Panasonic provides a zero-touch provisioning mechanism in their firmware, which causes the factory-reset phones to connect to the [Panasonic website](#) to check if a custom provisioning URL is configured for the MAC address of the phone. If an association between the MAC and a provisioning URL is found, the web service redirects the phone to the provisioning URL, where the phone connects to in order to obtain the configuration file.

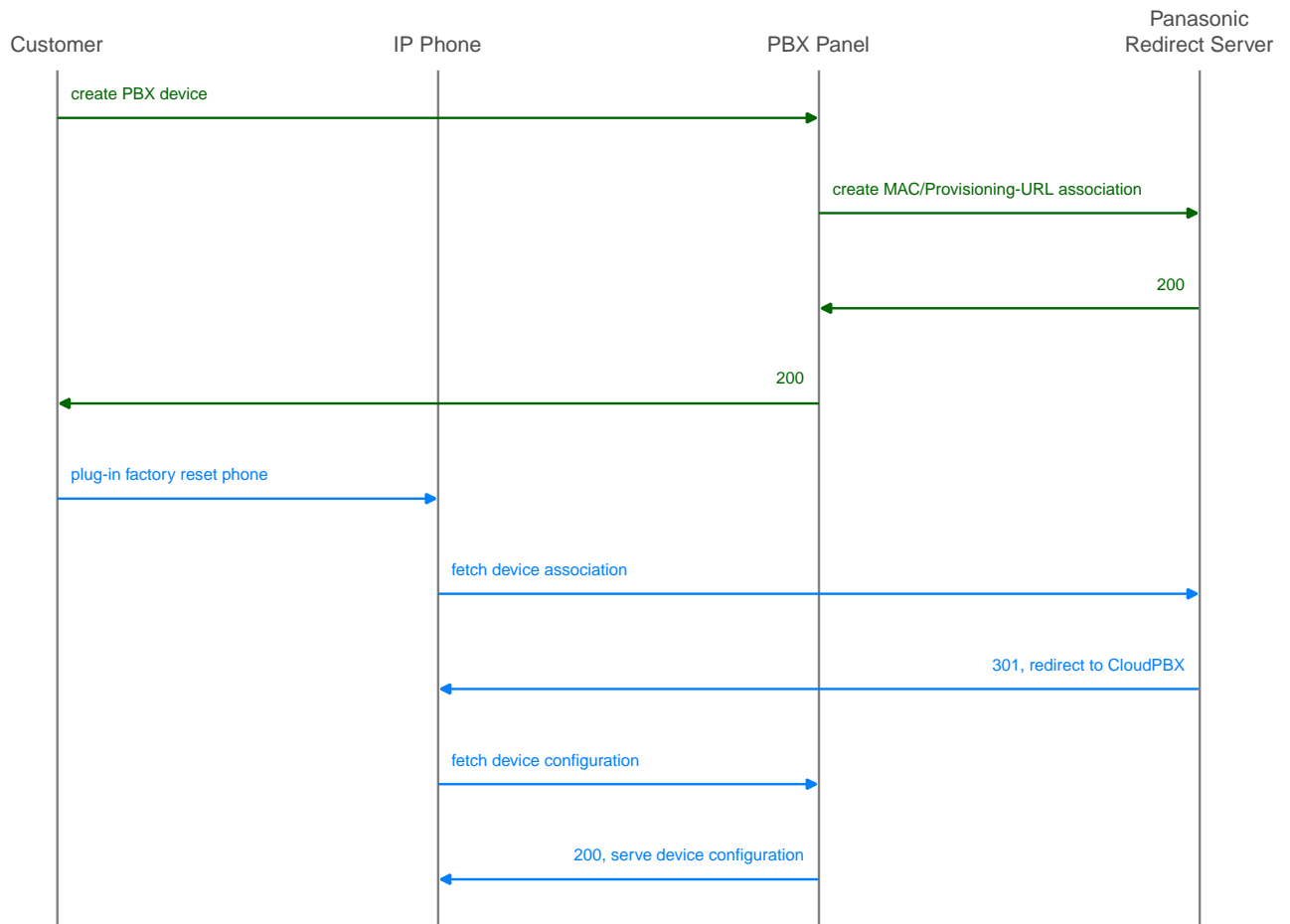

Figure 183. Initially bootstrap a Panasonic phone

The CloudPBX module ensures that when an end customer creates a Panasonic device, the MAC address is automatically provisioned on the Panasonic web service via an API call, so the customer's phone can use the correct provisioning URL to connect to the auto-provisioning server of the CloudPBX.

As a result, no customer interaction is required to bootstrap Panasonic phones, other than just creating the phone with the proper MAC on the CloudPBX web interface.

### Factory Reset

For already provisioned phones, the end customer might need to perform a factory reset:

- Press *Settings* or *Setup*
- Enter *#136*
- Select *Factory Setting* and press *Enter*
- Select *Yes* and press *Enter*
- Select *Yes* and press *Enter*

The default username for factory-reset phones is *admin* with password *adminpass*.

### Subsequent Device Resyncs

The same procedure as with Cisco SPA phones applies, once a subscriber configured on the phone is registered.

## SNOM Device Bootstrap

### Initial Bootstrapping

SNOM provides a zero-touch provisioning mechanism in their firmware, which causes the factory-reset phones to connect to the [SNOM website](#) to check if a custom provisioning URL is configured for the MAC address of the phone. If an association between the MAC and a provisioning URL is found, the web service redirects the phone to the provisioning URL, where the phone connects to in order to obtain the configuration file.

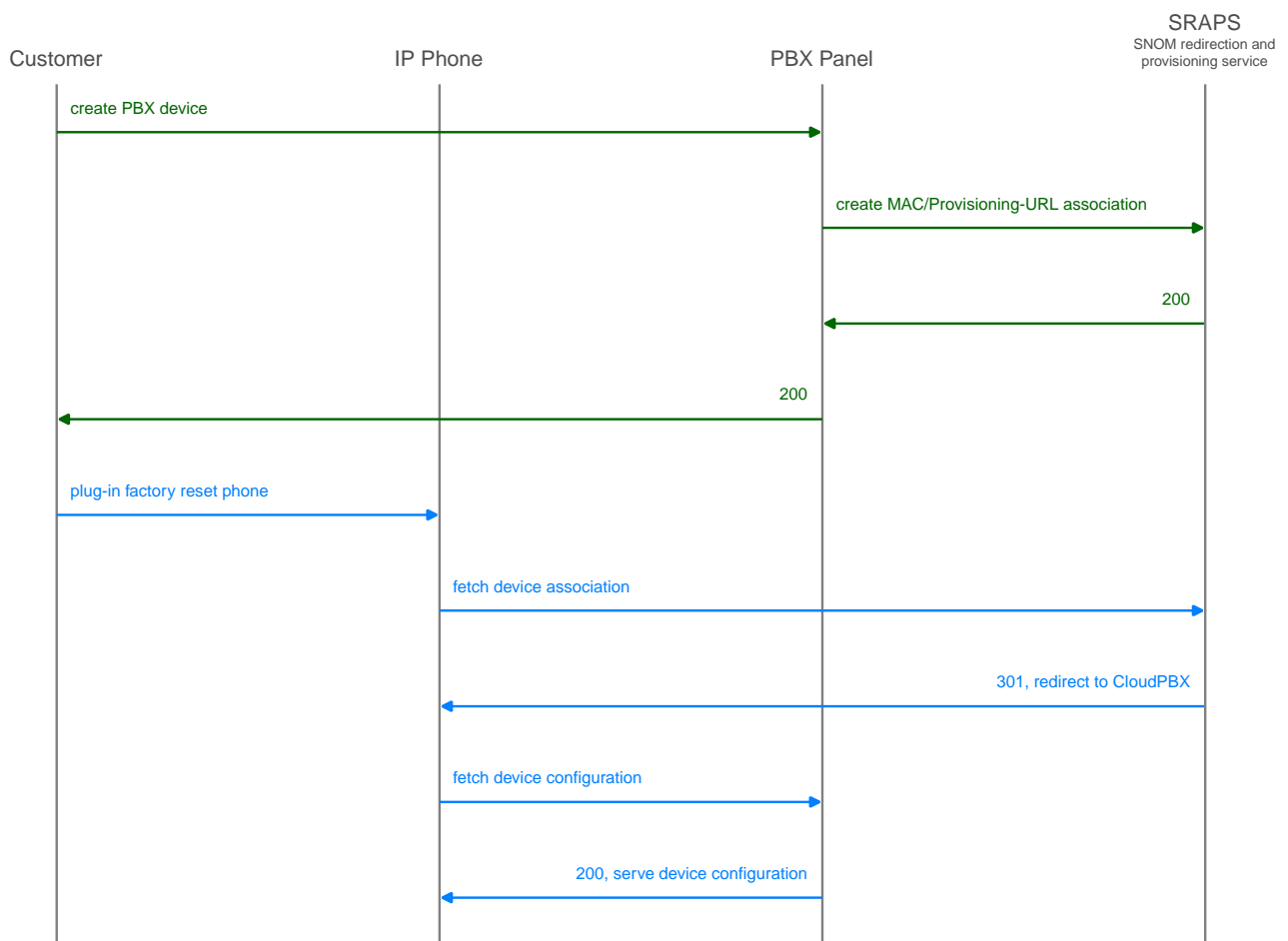

Figure 184. Initially bootstrap a SNOM phone

The CloudPBX module ensures that when an end customer creates a SNOM device, the MAC address is automatically provisioned on the SNOM web service via an API call, so the customer's phone can use the correct provisioning URL to connect to the auto-provisioning server of the CloudPBX.

As a result, no customer interaction is required to bootstrap SNOM phones, other than just creating the phone with the proper MAC on the CloudPBX web interface.

### Linking SNOM Handsets with SNOM M900 Base Station

To add a handset to a base station and to assign a subscriber to the handset, open preferences of a

subscriber and add the IPUi of the handset into the settings field 'gpp0' (the gpp number can be changed in device config if necessary).

**IMPORTANT**

IPUIs have to start with 0x (e.g. if IPUI is 123456789, set gpp0 equal to 0x123456789)

**IMPORTANT**

If a new IPUI is added, a base station config reload is necessary. It happens periodically on automated bases or base station reboot.

**Updating SNOM Firmware**

**For D-Series Phones:** It is recommended to use the [SNOM Update Center URL](#) to update the firmware of phones and base stations. SNOM firmware files are signed and the phones check the signatures of the files during provisioning. This makes sure only a proper SNOM firmware can be installed on the phones via HTTP. HTTPS transport might be unreliable on newly started devices due to wrong date/time. The firmware can be downloaded from NGCP as well. In the Device Configuration XML config, there is a commented line pointing to NGCP.

```
<firmware>[% config.bootstrap ? firmware.booturl : firmware.baseurl %]/[% config.mac
#%]/from/0/latest/</firmware>
```

**For M-Series Base Stations:** M-Series base stations require the user to define the *version* and *branch* of the firmware to update to. By default, this version is set to V510B01. If a different firmware version is needed, it has to be manually changed in the Device Configuration XML config.

```
<fp_fwu_sw_version>510</fp_fwu_sw_version>--
```

```
<fp_fwu_branch_version>1</fp_fwu_branch_version>
```

**IMPORTANT**

Base stations with firmware below version V500B1 cannot directly upgrade to the newest firmware. Please double check vendor upgrade recommendations and limitations on the SNOM website.

**For Handsets to use with M-Series Base Stations:** Handsets require you to add the version, branch and type of device you want to update separately like this:

```
<pp_fwu_sw_version type="M65">510</pp_fwu_sw_version>--
```

```
<pp_fwu_branch_version type="M65">1</pp_fwu_branch_version>
```

**IMPORTANT**

If a new handset is added to a base station, a reboot is required to apply the update settings

**IMPORTANT**

Handsets require the included charger to complete the firmware upgrade.

Additionally, handsets also require you to add the IPUI of the handset you want to update. This step can be done via NGCP. Go to the subscriber settings, search for setting *gpp*, use an unused gpp preference and add the IPUI in here. It is possible to use any general purpose field from subscriber preferences (gpp1, gpp2, ...) until it matches PBX Device Configuration for XML attribute "<subscr\_dect\_ipui>".

**IMPORTANT**

IPUIs have to start with 0x, for example 0x123456789

**Acquiring the IP of SNOM Base Stations**

To get the IP address of the base stations close to you, use a SNOM Handset, go to the applications menu and type \*47\*. All base stations should show up in a list view with their IP Address.

### **Adding Vertical Service Code Wrappers into D-Series Templates**

The [Vertical Service Code \(VSC\) Interface](#) offers a list of codes which can be masked by using specific "wrappers" tags within SNOM D-Series devices. Some examples for Reminder, Call Forward Unconditional and Speed Dial features are provided as follows:

```
<functionKeys e="2">
<fkey idx="3" context="1" lp="on" default_text="Reminder"
icon_type="kIconTypeFkeyClock" perm="">url
http://192.168.91.254/sipwise/vcs_mb.xml#sub=*[@id="vcs_55"]&var:sc_
vcs_55_on=*55&var:sc_vcs_55_default=0830</fkey>
<fkey idx="4" context="1" lp="on" default_text="CFU"
icon_type="kIconTypeFkeyTransfer" perm="">url
http://192.168.91.254/sipwise/vcs_mb.xml#sub=*[@id="vcs_72"]&var:sc_
vcs_72_on=*72&var:sc_vcs_72_off=#72</fkey>
<fkey idx="5" context="1" lp="on" default_text="SpeedDial"
icon_type="kIconTypeFkeySpeedDial" perm="">url
http://192.168.91.254/sipwise/vcs_mb.xml#sub=*[@id="vcs_50"]&var:sc_
vcs_50_on=*50&var:sc_vcs_50_default_slot=1</fkey>
</functionKeys>
```

[\* TAGS default \*]

#### **IMPORTANT**

On the example above, the XML file 'vcs\_mb.xml' needs to be placed on an external HTTP Server, or needs to be provisioned into the phone.

Please, contact SNOM for further assistance, or check SNOM Service Hub (Keyword: VCS Sipwise) if needed.

### **Factory Reset**

For already provisioned phones, the end customer might need to perform a factory reset:

- Press \*\*## (the phone starts to reboot)
- Hold # during boot
- Press 1 to choose the option *Settings reset*

The default keypad password is 0000. The WEB username for factory-reset phones is *admin* with password *admin*.

See more details on [SNOM Wiki](#).

### **Bootstrap URL**

The default SNOM bootstrap URI is: `http://<ngcp.fqdn>:1445/device/autoprov/bootstrap/{mac}` You can find the URI above on SRAPS WEB interface for newly provisioned SNOM device. The variable "{mac}" will expand to device MAC address automatically on SNOM device before connecting to NGCP. You can change the default "Bootstrap URI" on page "Edit Device Model". See more details in [PBX](#)

[bootstrap, firmwares and security](#).

**NOTE**

We strongly recommended using a secure bootstrap config:  
`https://<ngcp.fqdn>:1444/device/autoprov/config/{mac}`

The bootstrap config should point to the proper firmware:

```
http://<ngcp.fqdn>:1445/device/autoprov/firmware/{mac}/from/{firmware_ve  
rsion}/next
```

The variable '{firmware\_version}' is available for SNOM firmware [version 1.10.47+](#).

For earlier SNOM firmwares it is recommended to build a custom firmware upgrade vector using:

```
http://<ngcp.fqdn>:1445/device/autoprov/firmware/{mac}/from/0/latest  
OR  
http://<ngcp.fqdn>:1445/device/autoprov/firmware/{mac}/from/0/next/<tag>
```

See more details in [PBX bootstrap, firmwares and security](#).

## Yealink Device Bootstrap

### *Initial Bootstrapping*

Yealink provides a zero-touch provisioning mechanism in their firmware, which causes the factory-reset phones to connect to the [Yealink web service](#) to check if a custom provisioning URL is configured for the MAC address of the phone. If an association between the MAC and a provisioning URL is found, the web service redirects the phone to the provisioning URL, where the phone connects to in order to obtain the configuration file.

If both Cisco SPA and Yealink phones are used, an issue with the Cisco-signed server certificate configured on the provisioning port (1444 by default) of the CloudPBX provisioning server arises. Yealink phones by default only connect to trusted server certificates, and the Cisco CA certificate used to sign the server certificate is not trusted by Yealink. Therefore, a two-step approach is used to disable the trusted check via a plain insecure http port (1445 by default) first, where only device-generic config options are served. No user credentials are provided in this case, because no SSL client authentication can be performed. The generic configuration disables the trusted check, and at the same time changes the provisioning URL to the secure port, where the Yealink phone is now able to connect to.

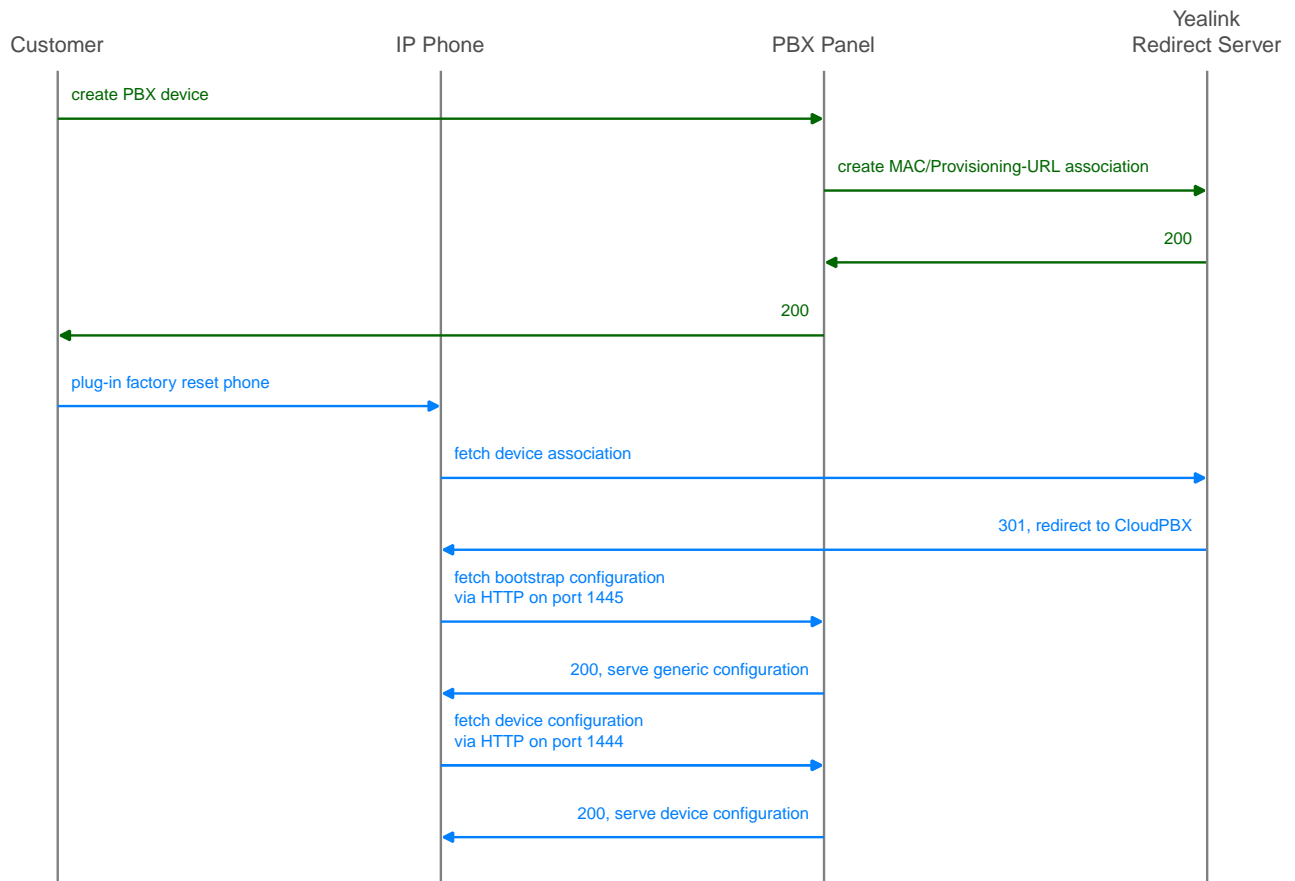

Figure 185. Initially bootstrap a Yealink phone

The CloudPBX module ensures that when an end customer creates a Yealink device, the MAC address is automatically provisioned on the Yealink web service via an API call, so the customer's phone can use the correct insecure bootstrap provisioning URL to connect to the auto-provisioning server of the CloudPBX for the generic configuration, which in turn provides the information on where to connect to for the secure, full configuration.

As a result, no customer interaction is required to bootstrap Yealink phones, other than just creating the phone with the proper MAC on the CloudPBX web interface.

### Factory Enable Yealink Auto-Provisioning

Older Yealink firmware does not automatically connect to the Yealink auto-provisioning server on initial boot, so it needs to be enabled manually by the end customer.

- Log in to <http://phone-ip/servlet?p=hidden&q=load> using *admin* and *admin* as user/password when prompted
- Change *Redirect Active* to *Enabled*
- Press *Confirm* and power-cycle phone

### Subsequent Device Resyncs

The same procedure as with Cisco SPA phones applies, once a subscriber configured on the phone is registered.

## Audiocodes Mediant Device Bootstrap and Configuration

### Initial Bootstrapping

An Audiocodes device provides a zero-touch provisioning mechanism in its firmware which causes a factory-reset device to connect to the URL built into the firmware. This URL points to Sipwise C5 provisioning server (in case of Sipwise C5 Carrier: web01 node) listening on TCP port 1444 for HTTPS sessions.

The prerequisites for the device provisioning are that the device has a routable IP address and can reach the IP address of Sipwise C5 provisioning interface.

The Audiocodes device should request the firmware file or CLI configuration file from Sipwise C5 platform. The firmware versions and CLI config versions are decoupled from each other; Sipwise C5 can not enforce specific version of the firmware on the device. Instead, it should be requested by the device itself. In other words, provisioning is a 'pull' and not a 'push' process.

Sipwise C5 expects the provisioning request from the Audiocodes device after SSL handshake and serves the requested file to the device if the device provides valid MAC address as the part of the URL. The MAC address is used to identify the device to Sipwise C5 platform. The firmware and CLI config files are provided at the following URLs:

- the base URL to download firmwares:  
[https://<NGCP\\_IP>:1444/device/autoprov/firmware/001122334455/from/0/latest](https://<NGCP_IP>:1444/device/autoprov/firmware/001122334455/from/0/latest)
- the base URL to download CLI config:  
[https://<NGCP\\_IP>:1444/device/autoprov/config/001122334455](https://<NGCP_IP>:1444/device/autoprov/config/001122334455)

where 001122334455 should be replaced with the actual device's MAC address and <NGCP\_IP> with IP address of Sipwise C5 provisioning interface.

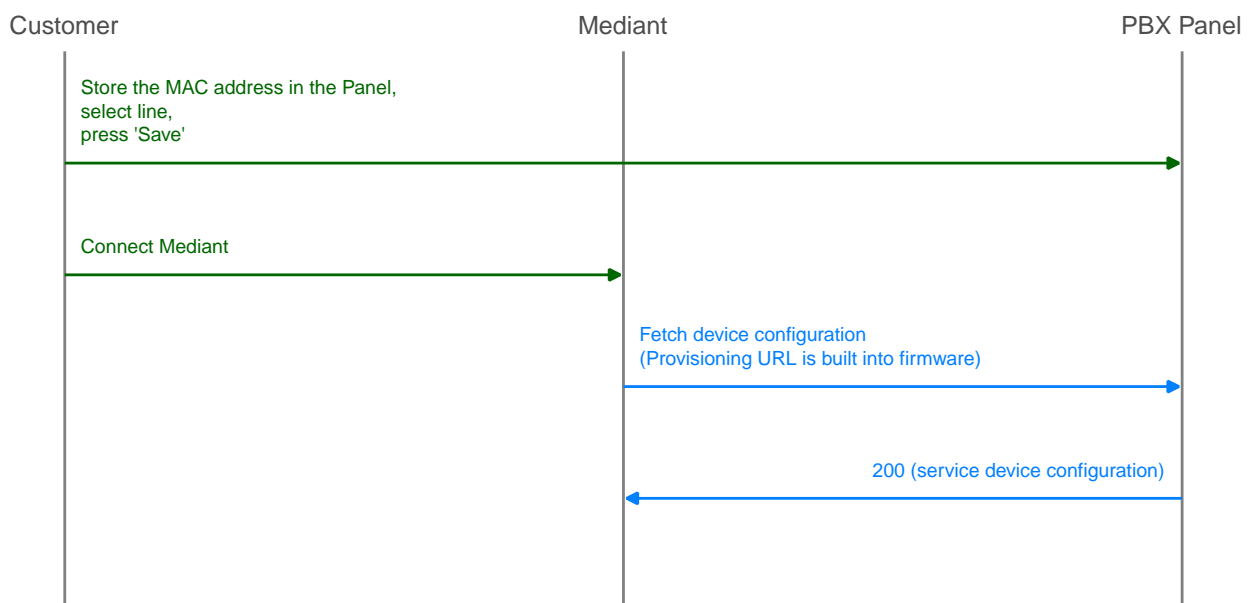

Figure 186. Initially bootstrap a Mediant gateway

### Device management basics

The list of device models, firmware and configurations are global to a reseller and are available to the

end customer. This data is initially provided by the Sipwise as bulk upload of all supported phone models. The firmware and settings are stored in the database on the DB node pair(s). The Sipwise C5 leverages the Cloud PBX module with its template system to generate the configurations and firmware files from the database on the fly. Please refer to the following chapters in Sipwise C5 handbook for the current information on how to perform device management:

- [Uploading device firmwares](#)
- [Creating device configuration](#)
- [Creating device profiles](#)

### ***Parameterizing the Device Configuration Template***

The device-specific parameters are filled in by the system individually when a physical device fetches its configuration file. Parameters from Sipwise C5 panel:

- username: Subscriber Details Master Data SIP Username
- password: Subscriber Details Master Data SIP Password
- domain: Subscriber Details Master Data Domain
- extension: Subscriber Details Master Data Extension
- area code: Subscriber Preferences Number Manipulations ac
- country code: Subscriber Preferences Number Manipulations cc

The produced **CLI config file** has the following structure:

1. SIP account credentials:

```
"sip-definition account 0"
```

```
user-name [username]
password [password]
host-name [domain]
register reg
contact-user "[country code][area code][extension]"
```

2. IP Groups:

```
"voip-network ip-group 1" and "voip-network ip-group 2"
```

```
sip-group-name [domain]
```

3. Proxy and registration settings:

```
"sip-definition proxy-and-registration"
```

```
set gw-name [domain]
```

## 4. Manipulations:

manipulation-name "from trunk domain":

```
"sbc manipulations message-manipulations 3"
```

```
action-value "[% line.domain %]"
```

manipulation-name "clip no screening":

```
"sbc manipulations message-manipulations 8"
```

```
action-value "\<sip:[country code][area code][extension]@' + param.ipg.dst.host + \>"
```

*Specific CLI parameters are:*

- [IPPBX\_Hostname]
- [IPPBX\_server\_IP]

which are used at the following configuration parameters:

- Proxy settings:

```
"voip-network proxy-ip 1"
```

```
proxy-address [IPPBX_Hostname]
```

- Manipulations:

```
"sbc manipulations message-manipulations 1"
```

```
action-value [IPPBX_Hostname]
```

### 8.1.13. PBX bootstrap, firmwares and security

In theory, it is enough to provide the device with one config file which contains all parameters inside (including SIP credentials and a link to the new firmware). However, the connection from device to the server has to be secure due to the sensitive data inside the config file. A SSL tunnel must be used and the server must authenticate the phone using the client SSL certificate.

Due to real-world logistic constraints, the received device may potentially have an outdated firmware, which could render it classified as an "insecure client" when connecting to the recently updated SSL server. Instances of this scenario include mismatches in TLS versions, SSL cipher suites, and elliptic curves, among other factors.

The only option to connect such a device to the server is to use more modern firmware and the only way to receive it is to download it from server. Some vendors provide initial/constant firmware upgrade as a part of their zero-touch provisioning platforms while it is not always possible to use it.

The NGCP platform also provides bootstrap functionality for such old devices/firmwares using 'bootstrap' concept. Please note the difference:

- config: `https://<ngcp.server>:1444/device/autoprov/config/<mac>`
- bootstrap: `http://<ngcp.server>:1445/device/autoprov/bootstrap/<mac>`

The first SSL-based link provides a valid device config with all details, while the second/insecure link only provides a minimal config to update the firmware. Modern firmwares are usually SHA256 signed and can be securely re-distributed using insecure channels.

By default, the bootstrap URI is `http://...:1445/device/autoprov/bootstrap/<mac>` and can be changed on page "Edit Device Model" (field 'Bootstrap URI').

#### NOTE

The bootstrap URI contains vendor specific variables, e.g. lower cased "[mac]" for SNOM and upper cased [MAC] for Panasonic. Please check the list of supported variables on the device vendor Website. Keep in mind, some variables might not be supported by very old firmware.

NGCP provides three access points by default: "config" (port 1444), "bootstrap" (port 1445) and "cisco" (port 1447). The last one is necessary due to the specific SSL setup for Cisco devices, see [Server Certificate Authentication](#). Using "bootstrap"/"cisco" entrance is not mandatory and only necessary to bootstrap devices with very old firmware.

NGCP provides a flexible way to build a chain of bootstraps/configs to achieve the desired upgrade path. Every config/bootstrap contains the link on the next config/bootstrap. A Device can (and often should) upgrade several firmware versions to achieve the latest firmware version. Some vendors do not support upgrading from old, ancient firmware to the latest firmware directly. The specific upgrade path should be built.

NGCP supports various URIs to fetch any firmware using version and/or tag. For example, you can request some specific firmware version using:

```
https://<ngcp.fqdn>:1444/device/autoprov/firmware/<mac>/version/{firmware_version}
https://<ngcp.fqdn>:1447/device/autoprov/firmware/<mac>/version/{firmware_version}
http://<ngcp.fqdn>:1445/device/autoprov/firmware/<mac>/version/{firmware_version}
```

All methods are available for any "config/bootstrap/cisco" entrances. Also firmware can be requested using "Firmware tag" (NGCP searches versions first and repeats the search using the tag if nothing found by the version):

```
https://<ngcp.fqdn>:1444/device/autoprov/firmware/<mac>/version/{firmware_tag}
https://<ngcp.fqdn>:1447/device/autoprov/firmware/<mac>/version/{firmware_tag}
http://<ngcp.fqdn>:1445/device/autoprov/firmware/<mac>/version/{firmware_tag}
```

It is also possible to request the "latest" and the "next" firmware from your current position

```
https://<ngcp.fqdn>:1444/device/autoprov/firmware/<mac>/from/<firmware_v
ersion>/latest
https://<ngcp.fqdn>:1444/device/autoprov/firmware/<mac>/from/<firmware_v
ersion>/next
https://<ngcp.fqdn>:1444/device/autoprov/firmware/<mac>/from/<firmware_v
ersion>/latest/<tag>
https://<ngcp.fqdn>:1444/device/autoprov/firmware/<mac>/from/<firmware_v
ersion>/next/<tag>
```

For example, NGCP has 7 firmwares configured for SNOM D715 with MAC 0004138aa403. For simplicity, let's call those firmware versions: 1, 2, 3, 4, 5, 6, 7. The firmwares '4' and '6' have the same tag 'mytag'. The latest firmware is firmware with id '7' and it has no tag set.

The endpoint 'latest' gives access to firmware '6' only (if 'mytag' is used):

```
> curl
http://myserver.com:1445/device/autoprov/firmware/0004138aa403/from/0/la
test
firmware 7

> curl
http://myserver.com:1445/device/autoprov/firmware/0004138aa403/from/0/la
test/mytag
firmware 6
```

The endpoint 'next' allows to address the complete chain of firmwares using tags:

```
> curl
http://myserver.com:1445/device/autoprov/firmware/0004138aa403/from/0/ne
xt
firmware 1 # the next firmware after version '0' is firmware '1'

> curl
http://myserver.com:1445/device/autoprov/firmware/0004138aa403/from/0/ne
xt/mytag
firmware 4 # the next firmware after version '0' with tag 'mytag' is
firmware '4'

> curl
http://myserver.com:1445/device/autoprov/firmware/0004138aa403/from/2/ne
xt/mytag
firmware 4 # the same as above, the firmware after version '2' with tag
'mytag' is firmware '4'

> curl
http://myserver.com:1445/device/autoprov/firmware/0004138aa403/from/4/ne
xt/mytag
```

```
firmware 6 # the next firmware after version '4' with tag 'mytag' is
firmware '6'
```

### 8.1.14. Device Provisioning and Deployment Workflows

This chapter provides information and hints for preparing and performing the deployment of certain VoIP devices at customer sites, that have a customer-facing interface which also needs customisation.

#### Audiocodes Mediant Device Provisioning Workflow

Audiocodes ISDN gateways and eSBCs are devices used to connect legacy (ISDN) PBX and IP-PBX to Sipwise C5 platform and maintain their operations within the Operator's network. The Sipwise C5 offers a *SIPConnect 2.0* compliant signaling and media interface to connect SIP trunks to the platform. In addition to this interface, the Sipwise C5 provides an auto-provisioning mechanism to configure SIP endpoints like IP phones, media gateways and eSBCs.

#### Provisioning URL

An Audiocodes device needs to obtain the provisioning URL of the Sipwise C5 in one way or another, to request its device configuration and subsequently download specific firmware, obtain SIP credentials to connect to the network facing side, and configure the customer facing side for customer devices to connect either via ISDN or SIP. Typical ways of obtaining the provisioning URL for a SIP endpoint are:

- using DHCP option-66 (in a pre-staging environment or directly at the customer premise) where vendor-specific Redirect Servers are configured in the default configuration or firmware
- getting pre-configured per deployment from the SIP endpoint vendor
- getting pre-configured per deployment by a 3rd party distributor

The assumption is that Audiocodes devices are supplied with a firmware (and all required SSL certificates) being pre-configured and the provisioning URL pointing to an Operator URL Sipwise C5 is serving, before handing the devices over to field service engineers doing the truck rolls.

#### Field Configuration

The Sipwise C5 provides a SIPConnect 2.0 compliant interface on the network side for the Audiocodes devices. This interface defines the numbering formats of the calling and called party, the SIP header mechanisms to provide CLI restriction, the RTP codecs, etc.

On the customer facing side, however, those variables might be different from deployment to deployment:

- An IP-PBX might choose to only send its extension as calling party number, or might choose to send the full number in national format.
- It might choose to use the SIP From-header mechanisms to suppress displaying of the CLI, or use the SIP Privacy header.
- The same uncertainty exists to some extent for a legacy PBX connecting via ISDN to the Audiocodes device.

The assumption here is that a field service engineer is NOT supposed to change the Audiocodes configuration in order to make the customer interface work, as this will lead to big issues in maintaining

those local changes, especially if a replacement of the device is necessary. Instead, the Audiocodes configuration must ensure that all different kinds of variants in terms of SIP headers, codecs and number formats are translated correctly to the network side and vice versa. If it turns out that there are scenarios in the field which are not handled correctly, temporary local changes might be performed to finish a truck roll, but those changes **MUST** be communicated to the platform operator, and the server-side configuration templates must be adapted to handle those scenarios gracefully as well.

For deployments with ISDN interfaces on the customer facing side of the Audiocodes, different *Device Profiles* with specific *Device Configurations* per *Device Model* must exist to handle certain scenarios, specifically whether the ISDN interface is operating in Point-to-Point or Point-to-Multipoint mode. Configuration options like which side is providing the clock-rate are to be defined up-front, and the PBX must be reconfigured to adhere to the configuration.

### **Network Configuration**

On the network facing side, both the ISDN and eSBC style deployments have to be designed to obtain an IP address via DHCP. The definition of the IP address ranges is up to the Operator. It may or may not be NAT-ed, but it is advised to use a private IP range directly routed in the back-bone to avoid NAT.

On the customer facing side, networking is only relevant for the eSBC deployment. In order to make the IP-PBX configuration as stream-lined as possible, a pre-defined network should be established on the customer interface of the Audiocodes device.

#### **TIP**

The proposal is to define a network 192.168.255.0/24 with the Audiocodes device using the IP 192.168.255.2 (leaving the 192.168.255.1 to a possible gateway). The IP-PBX could obtain its IP address via DHCP from a DHCP server running on the Audiocodes device (e.g. serving IP addresses in the range of 192.168.255.100-254), or could have it configured manually (e.g. in the range of 192.168.255.3-99). Since the Audiocodes device IP on the customer side is always fixed at 192.168.255.2, the IP-PBX for each customer can be configured the same way, pointing the SIP proxy/registrar or outbound proxy always to this IP.

The customer facing side is outside the Sipwise demarcation line, that is why the network configuration mentioned above only serves as proposal and any feedback is highly welcome. However, it must be communicated how the customer facing network is going to be configured, because the Sipwise C5 needs to incorporate this configuration into the Audiocodes configuration templates.

## **Audiocodes Mediant Device Deployment Workflow**

### **Pre-Configuration on Sipwise C5 platform**

1. Before connecting a customer to a SIP trunk, it must be clear which Audiocodes *Device Model* is going to be used (depending on if, which and how many ISDN ports are necessary) and which *Device Profile* for the *Device Model* is required (eSBC mode, ISDN P-to-P or P-to-MP mode). Based on that, the correct physical device must be picked.
2. Next, the customer has to be created on the Sipwise C5. This step requires the creation of the customer, and the creation of a subscriber within this customer. For the subscriber, the proper E.164 numbers or number blocks must be assigned, and the correct subscriber preferences must be set for the network interface to adhere to the SIPConnect 2.0 interface. This step is automated by a script provided by Sipwise until the provisioning work-flow is fully integrated with Operator's OSS/BSS systems. *Required parameters are:*

an external customer id to relate the customer entity on Sipwise C5 with a customer identifier in

Operator's IT systems

a billing profile name

a subscriber username and password, the domain the subscriber is configured for

the numbers or number blocks assigned to the subscriber, and the network provided number of the subscriber

optional information is geographic location information and IP network information to properly map emergency calls

3. Finally, the association between the MAC address of the Audiocodes device and the SIP subscriber to be used on the SIP trunk must be established. This step is also automated by a script provided by Sipwise. *Required parameters are:*

the subscriber id

the Device Profile to be used

and the MAC address of the Audiocodes device

### **Installation**

Once the above requirements are fulfilled and the customer is created on Sipwise C5, the Audiocodes device can be installed at the customer premise.

When the Audiocodes device boots, it requests the configuration file from Sipwise C5 by issuing a GET request via HTTPS.

For **authentication and authorization** purposes, Sipwise C5 requests an SSL client certificate from the device and will check whether it's signed by a Certificate Authority (CA) known to Sipwise C5. Therefore, Audiocodes must provide the CA certificate used to sign the devices' client certificates to Sipwise to allow for this process. Also, Sipwise C5 will provide an SSL server certificate to the device. The device must validate this certificate in order to prevent man-in-the-middle attacks. Options here are to have:

- Sipwise provides a self-signed certificate to Audiocodes for Audiocodes or a 3rd party distribution partner to configure it as trusted CA in the pre-staging process
- the Operator provide a certificate signed by a CA which is already in the trust store of the Audiocodes devices.

Once the secured HTTPS connection is established, Sipwise C5 will provide a CLI style configuration file, with its content depending on the pre-configured *Device Profile* and subscriber association to the device's MAC address.

The configuration includes the firmware version of the latest available firmware configured for the *Device Model*, and a URL defining from where to obtain it. The configuration details on how the Audiocodes devices manage the scheduling of firmware updates are to be provided by Audiocodes or its partners, since this is out of scope for Sipwise. Ideally, firmware updates should only be performed if the device is idle (no calls running), and within a specific time-frame (e.g. between 1 a.m. and 5 a.m. once a certain firmware version is reached, including some random variation to prevent all devices to download a new firmware version at the same time).

### **Device Replacement**

If a customer requires the replacement of a device, e.g. due to hardware issues or due to changing the number or type of ISDN interfaces, a new association of the new device MAC, its *Device Profile* and the

subscriber must be established.

In order to make the change as seamless as possible for the customer, a new device is created for the customer with the new MAC, a proper *Device Profile*, but the same subscriber as used on the old device. Once the new device boots at the customer premise, it will obtain its configuration and will register with the same subscriber as the old device (in case it is still operational). For inbound calls to the customer, this will cause parallel ringing to take place, and it is up to the customer or the field engineer when to re-configure or re-cable the PBX to connect to one or the other device.

Once the old device is decommissioned, the old MAC association can be deleted on Sipwise C5.

### 8.1.15. Adjusting the PBX Devices Configuration

Usually, everything required for PBX devices autoprovisioning is uploaded automatically as described in [PBX Device Provisioning](#). In case you would like to introduce changes into a PBX device configuration, create a custom PBX device profile or even upload a newer firmware, this section will help you.

The *Device Management* is used by admins and resellers to define the list of device models, firmware and configurations available for end customer usage. These settings are pre-configured for the default reseller up-front by the Sipwise and have to be set up for every reseller separately, so a reseller can choose the devices he'd like to serve and potentially tweak the configuration for them. [List of available pre-configured devices](#).

End customers choose from a list of *Device Profiles*, which are defined by a specific *Device Model*, a list of *Device Firmwares* and a *Device Configuration*. The following sections describe the setup of these components.

To do so, go to *Settings* *Device Management*.



Figure 187. Device Management

### Setting up Device Models

A *Device Model* defines a specific hardware device, like the vendor, model name, the number of keys and their capabilities. For example a Cisco SPA504G has 4 keys, which can be used for private lines, shared lines (SLA) and busy lamp field (BLF). If you have an additional attendant console, you get 32 more buttons, which can only do BLF.

In this example, we will create a Cisco SPA504G with an additional Attendant Console.

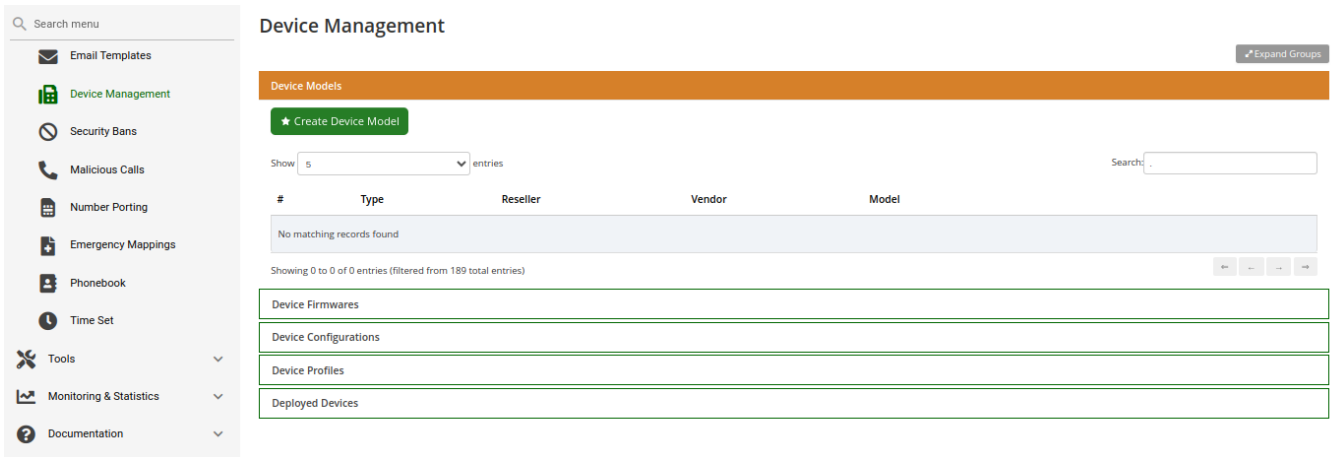

Figure 188. Create Device Model

Expand the *Device Models* row and click *Create Device Model*.

First, you have to select the reseller this device model belongs to, and define the vendor and model name.

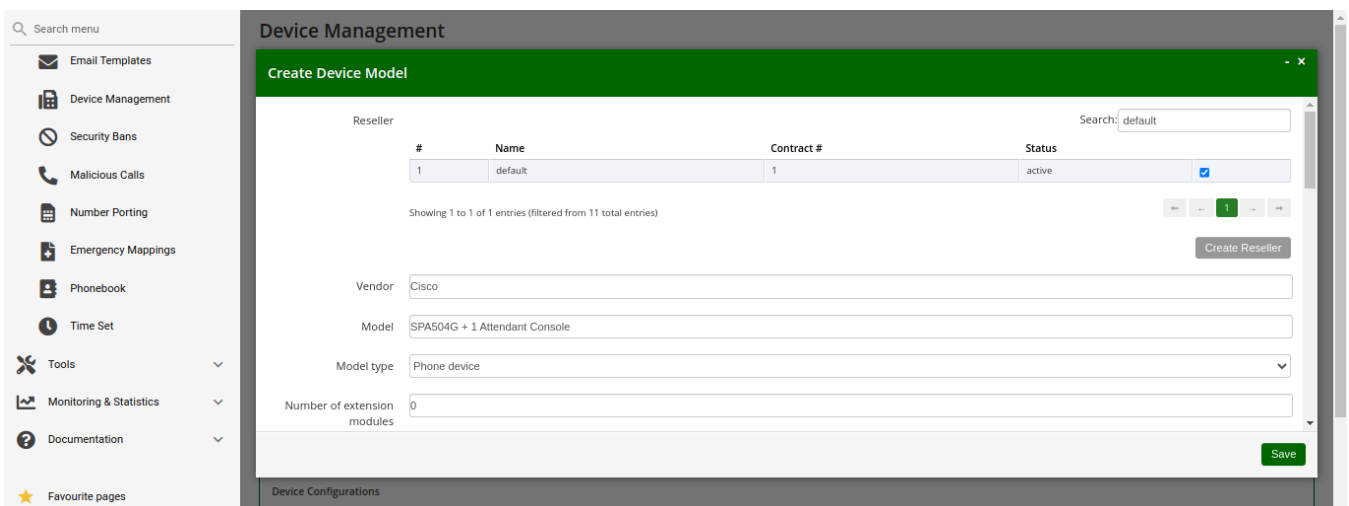

Figure 189. Create Device Model - Main

In the *Line/Key Range* section, you can define the first set of keys, which we will label *Phone Keys*. The name is important, because it is referenced in the configuration file template, which is described in the following sections. The SPA504G internal phone keys support private lines (where the customer can assign a normal subscriber, which is used to place and receive standard phone calls), shared lines (where the customer can assign a subscriber which is shared across multiple people) and busy lamp field (where the customer can assign other subscribers to be monitored when they get a call, and which also acts as speed dial button to the subscriber assigned for BLF), so we enable all 3 of them.

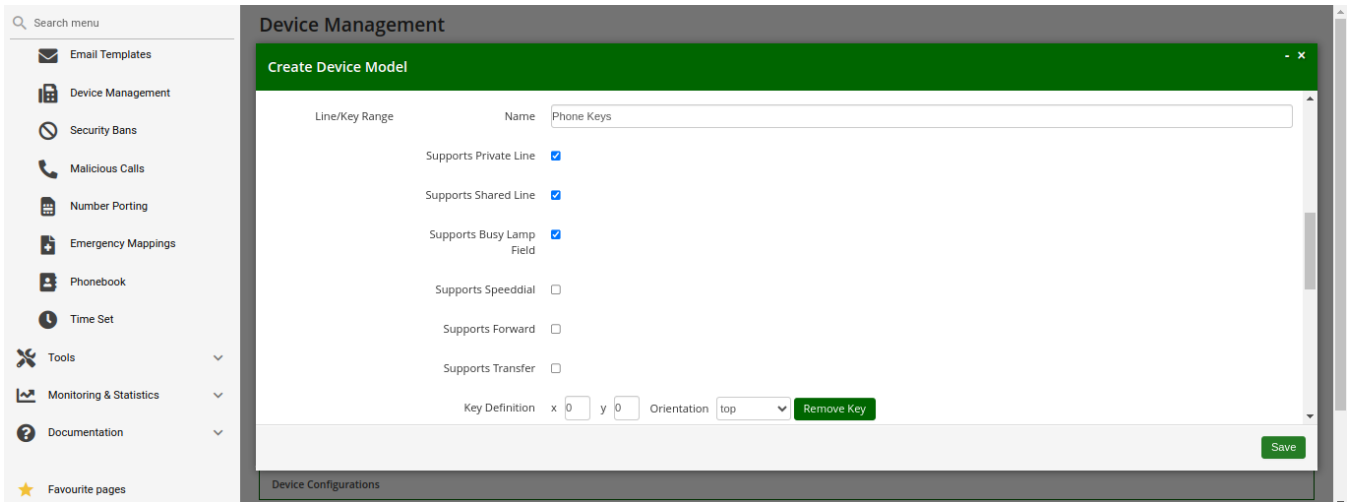

Figure 190. Create Device Model - Lines

In order to also configure the attendant console, press the *Add another Line/Key Range* button to specify the attendant console keys.

Again provide a name for this range, which will be *Attendant Console 1* to match our configuration defined later. There are 32 buttons on the attendant console, so set the number accordingly. Those 32 buttons only support BLF, so make sure to **uncheck** the private and shared line options, and only check the **Supports Busy Lamp Field** option.

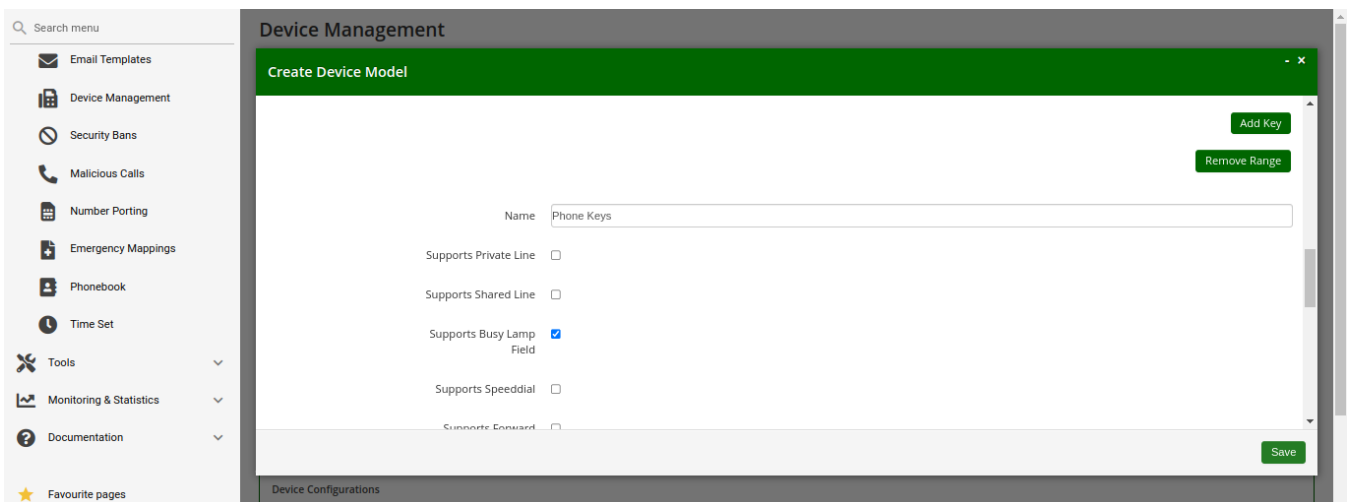

Figure 191. Create Device Model - Add a Line

The last two settings to configure are the *Front Image* and *MAC Address Image* fields. Upload a picture of the phone here in the first field, which is shown to the customer for them to recognize easily how the phone looks like. The MAC image is used to tell the customer where he can read the MAC address from. This could be a picture of the back of the phone with the label where the MAC is printed, or an instruction image how to get the MAC from the phone menu.

The rest of the fields are left at their default values, which are set to work with Cisco SPAs. Their meaning is as follows:

- *Bootstrap Sync URI*: If a stock phone is plugged in for the first time, it needs to be provisioned somehow to let it know where to fetch its configuration file from. Since the stock phone does not

know about your server, you have to define an HTTP URI here, where the customer is connected with his web browser to set the according field.

- *Bootstrap Sync HTTP Method*: This setting defines whether an HTTP GET or POST is sent to the Sync URI.
- *Bootstrap Sync Params*: This setting defines the parameters appended to the Sync URI in case of a GET, or posted in the request body in case of POST, when the customer presses the *Sync* button later on.

Finally press *Save* to create the new device model.

The screenshot shows the 'Create Device Model' form in the Device Management section. The form has a green header and a white body. On the left, there is a sidebar menu with various navigation options. The main form area contains the following fields:

- Bootstrap URI**: A text input field.
- Bootstrap Sync HTTP Method**: A dropdown menu currently set to 'GET'.
- Bootstrap Sync URI**: A text input field containing 'http://[% client.ip %]/admin/resync'.
- Bootstrap Sync Parameters**: A text input field containing '[% server.uri %]/\$SMA'.
- Front Image**: A file upload field with a 'Choose File' button and the text 'No file chosen'.
- Front Image Thumbnail**: A file upload field with a 'Choose File' button and the text 'No file chosen'.
- MAC Address Image**: A file upload field with a 'Choose File' button and the text 'No file chosen'.

A green 'Save' button is located at the bottom right of the form. The sidebar menu includes options like 'Email Templates', 'Device Management', 'Security Bans', 'Malicious Calls', 'Number Porting', 'Emergency Mappings', 'Phonebook', 'Time Set', 'Tools', 'Monitoring & Statistics', 'Documentation', and 'Favourite pages'.

Figure 192. Create Device Model - Bootstrap

## Uploading Device Firmwares

A device model can optionally have one or more device firmware versions. Some devices like the Cisco SPA series do not support direct firmware updates from an arbitrary to the latest one, but need to go over specific firmware steps. In the device configuration discussed next, you can return the *next* supported firmware version, if the phone passes the current version in the firmware URL.

Since a stock phone purchased from any shop can have an arbitrary firmware version, we need to upload all firmwares needed to get from any old one to the latest one. In case of the Cisco SPA3x/SPA5x series, that would be the following versions, if the phone starts off with version 7.4.x:

- spa50x-30x-7-5-1a.bin
- spa50x-30x-7-5-2b.bin
- spa50x-30x-7-5-5.bin

So to get an SPA504G with a firmware version 7.4.x to the latest version 7.5.5, we need to upload each firmware file as follows.

Open the *Device Firmware* row in the *Device Management* section and press *Upload Device Firmware*.

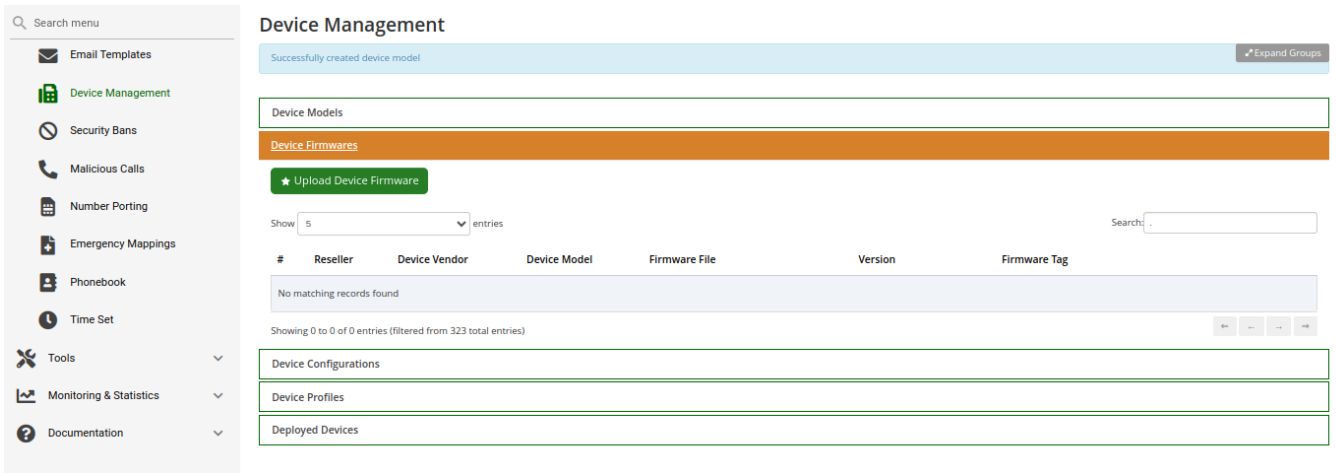

Figure 193. Device Firmware

Select the device model we are going to upload the firmware for, then specify the firmware version and choose the firmware file, then press *Save*.

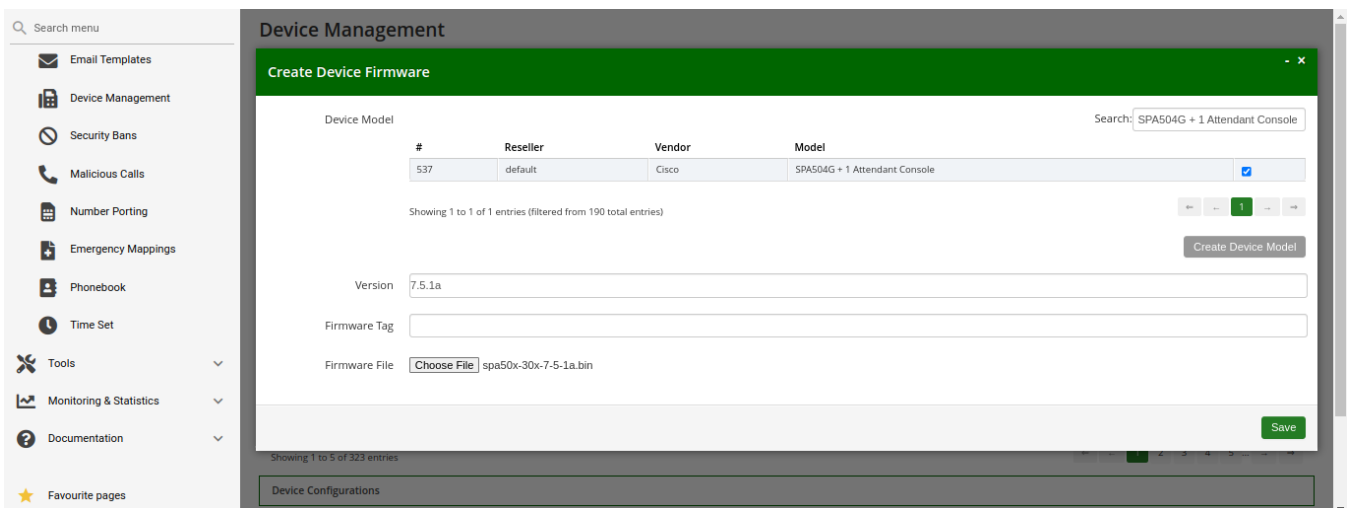

Figure 194. Upload Device Firmware

Repeat this step for every firmware in the list above (and any new firmware you want to support when it's available).

## Creating Device Configurations

Each customer device needs a configuration file, which defines the URL to perform firmware updates, and most importantly, which defines the subscribers and features configured on each of the lines and keys. Since these settings are different for each physical phone at all the customers, the Cloud PBX module provides a template system to specify the configurations. That way, template variables can be used in the generic configuration, which are filled in by the system individually when a physical device fetches its configuration file.

To upload a configuration template, open the *Device Configuration* row and press *Create Device Configuration*.

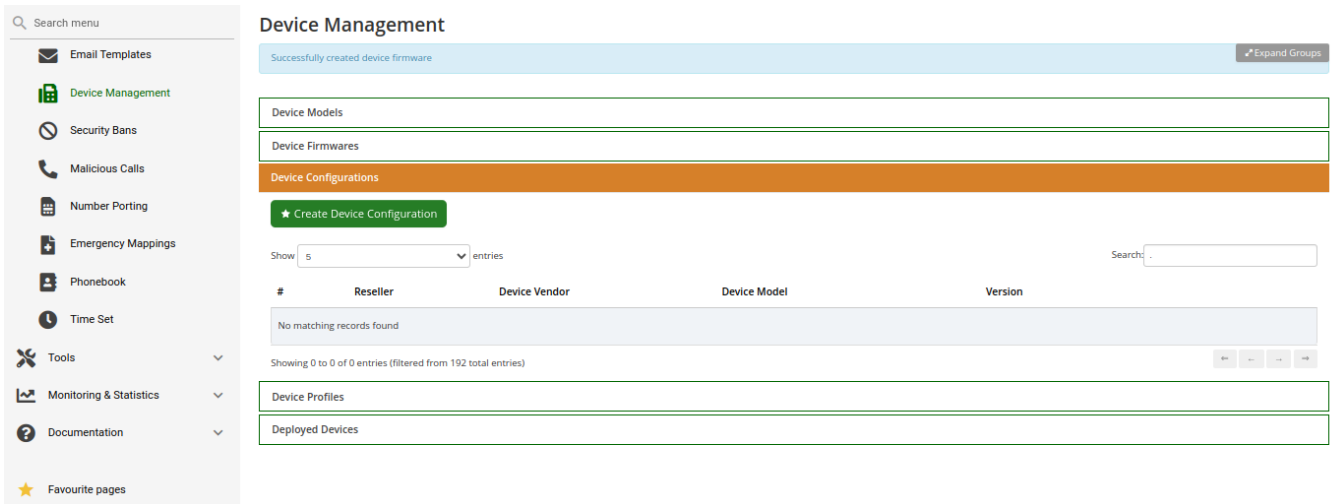

Figure 195. Device Configuration

Select the device model and specify a version number for this configuration (it is only for your reference to keep track of different versions). For Cisco SPA phones, keep the *Content Type* field to `text/xml`, since the configuration content will be served to the phone as XML file.

For devices other than the Cisco SPA, you might set `text/plain` if the configuration file is plain text, or `application/octet-stream` if the configuration is compiled into some binary form.

Finally paste the configuration template into the *Content* area and press *Save*.

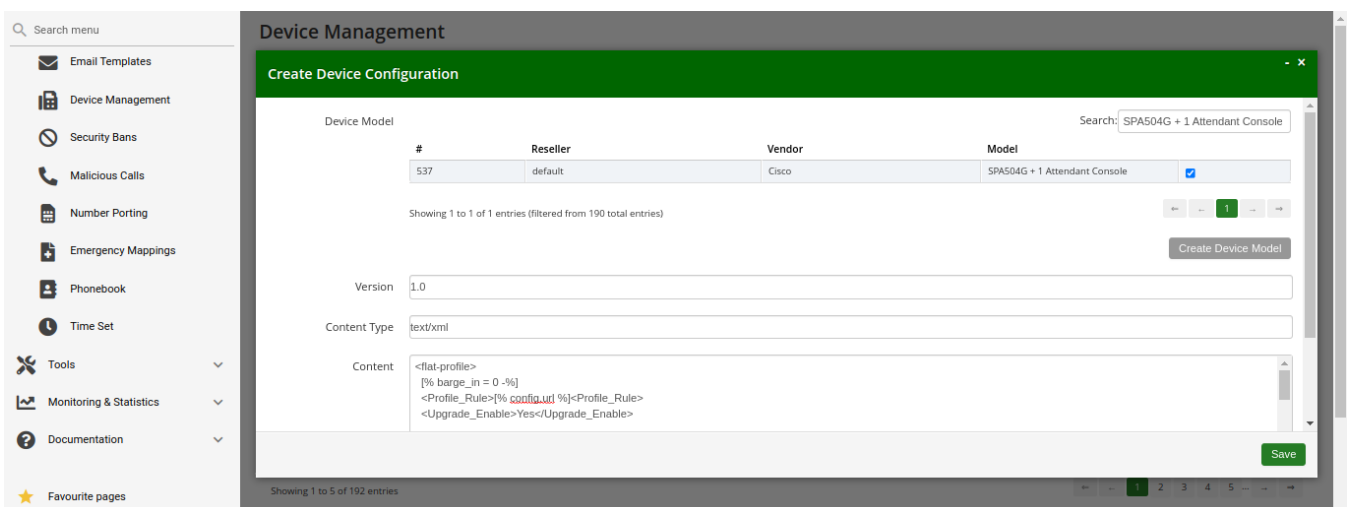

Figure 196. Upload Device Configuration

The templates for certified device models are provided by Sipwise, but you can also write your own. The following variables can be used in the template:

- `config.url`: The URL to the config file, including the device identifier (e.g. `http://sip.example.org:1444/device/autoprov/config/001122334455`).
- `config.baseurl`: The URL to the config file, without the device identifier (e.g. `http://sip.example.org:1444/device/autoprov/config/`).
- `config.mac`: The device MAC address.

- **config.filename**: The requested config filename (e.g. `001122334455-firmware.xml` in case the URL is `http://sip.example.org:1444/device/autoprov/config/001122334455-firmware.xml`).
- **firmware.maxversion**: The latest firmware version available on the system for the specific device.
- **firmware.baseurl**: The base URL to download firmwares (e.g. `http://sip.example.org:1444/device/autoprov/firmware`). To fetch the next newer firmware for a Cisco SPA, you can use the template line `[% firmware.baseurl %]/$MA/from/$SWVER/next`.
- **phone.model**: The device model. It is useful for the cases of a shared/common template for several devices within the same vendor.
- **phone.vendor**: The device vendor name. It is available for the general PBX template's flexibility.
- **phone.stationname**: The name of the station (physical device) the customer specifies for this phone. Can be used to show on the display of the phone.
- **phone.lineranges**: An array of lines/keys as specified for the device model. Each entry in the array has the following keys:
  - name**: The name of the line/key range as specified in the *Device Model* section (e.g. *Phone Keys*).
  - num\_lines**: The number of lines/keys in the line range (e.g. 4 in our *Phone Keys* example, or 32 in our *Attendant Console 1* example).
  - lines**: An array of lines (e.g. subscriber definitions) for this line range. Each entry in the array has the following keys:
    - keynum**: The index of the key in the line range, starting from 0 (e.g. **keynum** will be 3 for the 4th key of our *Phone Keys* range).
    - rangenum**: The index of the line range, starting from 0. The order of line ranges is as you have specified them (e.g. *Phone Keys* was specified first, so it gets **rangenum** 0, *Auto Attendant 1* gets **rangenum** 1).
    - type**: The type of the line/key, one of **private**, **shared**, **blf**, **speeddial**, **forward** or **transfer**.
    - username**: The SIP username of the line.
    - domain**: The SIP domain of the line.
    - password**: The SIP password of the line.
    - displayname**: The SIP Display Name of the line.

In the configuration template, you can adjust embedded variable references for the existing variables. Please also check the bootstrap section: [PBX bootstrap, firmwares and security](#). If you need other specific variables, please request their development from Sipwise.

#### TIP

In order to change the provisioning base IP and port (default 1444), you have to access `/etc/ngcp-config/config.yml` and change the value **host** and **port** under the **autoprov.server** section.

## Creating Device Profiles

When the customer configures his own device, he does not select a *Device Model* directly, but a *Device Profile*. A device profile specifies which model is going to be used with which configuration version. This allows the operator to create new configuration files and assign them to a profile, while still keeping older configuration files for reference or roll-back scenarios. It also makes it possible to test new

firmwares by creating a test device model with the new firmware and a specific configuration, without impacting any existing customer devices.

To create a *Device Profile* for our phone, open the *Device Profiles* row in the *Device Management* section and press *Create Device Profile*.

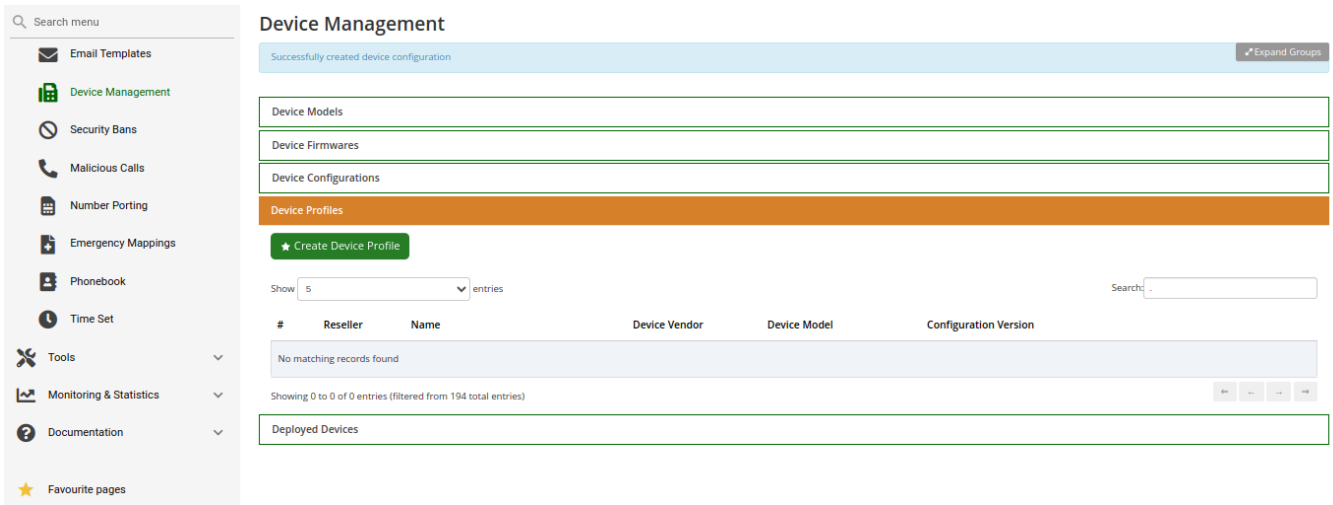

Figure 197. Device Profile

Select the device configuration (which implicitly identifies a device model) and specify a *Profile Name*. This name is what the customer sees when they are selecting a device they want to provision, so pick a descriptive name which unambiguously identifies a device. Press *Save* to create the profile.

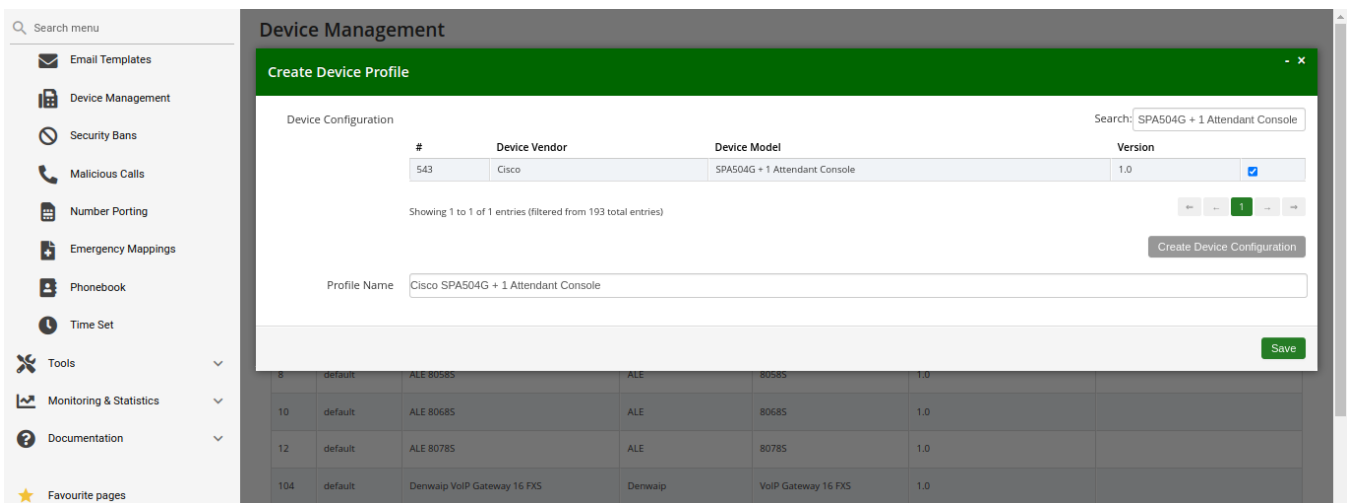

Figure 198. Create Device Profile

Repeat the steps as needed for every device you want to make available to customers.

### 8.1.16. List of available pre-configured devices

Vendor	Model	Available from release	Deprecated from release
ALE	8008	mr7.0.1.1	-
ALE	8018	mr7.0.1.1	-

Vendor	Model	Available from release	Deprecated from release
ALE	8028	mr7.0.1.1	-
ALE	8058	mr7.0.1.1	-
ALE	8068	mr7.0.1.1	-
ALE	8078	mr7.0.1.1	-
ALE	AOM10	mr7.0.1.1	-
ALE	AOM40	mr7.0.1.1	-
ALE	AOMEL	mr7.0.1.1	-
ALE	M3	mr10.2.1.1	-
ALE	M5	mr10.2.1.1	-
ALE	M7	mr10.2.1.1	-
ALE	M8	mr13.1.1.0	-
ALE	H3P	mr10.2.1.1	-
ALE	H6	mr10.2.1.1	-
Audiocodes	Mediant800	mr4.1.1.1	mr10.5.1.1
Cisco	ATA112	mr3.4.1.1	<a href="#">mr10.5.1.1</a>
Cisco	ATA122	mr3.4.1.1	<a href="#">mr10.5.1.1</a>
Cisco	SPA232D	mr3.4.1.1	<a href="#">mr10.5.1.1</a>
Cisco	SPA301	mr3.4.1.1	<a href="#">mr10.5.1.1</a>
Cisco	SPA303	mr3.4.1.1	<a href="#">mr10.5.1.1</a>
Cisco	SPA501G	mr3.4.1.1	<a href="#">mr10.5.1.1</a>
Cisco	SPA502G	mr3.4.1.1	<a href="#">mr10.5.1.1</a>
Cisco	SPA512G	mr3.4.1.1	<a href="#">mr10.5.1.1</a>
Cisco	SPA504G	mr3.4.1.1	<a href="#">mr10.5.1.1</a>
Cisco	SPA504G + SPA500S	mr3.7.1.4	<a href="#">mr10.5.1.1</a>
Cisco	SPA504G + two SPA500S	mr3.7.1.4	<a href="#">mr10.5.1.1</a>
Cisco	SPA514G	mr3.4.1.1	<a href="#">mr10.5.1.1</a>
Cisco	SPA508G	mr3.4.1.1	<a href="#">mr10.5.1.1</a>
Cisco	SPA509G	mr3.4.1.1	<a href="#">mr10.5.1.1</a>
Cisco	SPA525G	mr3.4.1.1	<a href="#">mr10.5.1.1</a>
Grandstream	HT814	mr5.1.1.1	-
Grandstream	GXW-4008	mr5.1.1.1	-
Grandstream	GXW-4216	mr5.1.1.1	-
Innovaphone	IP2X2X	mr3.8.3.3	mr10.5.1.1

Vendor	Model	Available from release	Deprecated from release
Innovaphone	IP230-X	mr3.8.3.3	mr10.5.1.1
Innovaphone	IP232	mr3.8.3.3	mr10.5.1.1
Innovaphone	IP222	mr3.8.3.3	mr10.5.1.1
Innovaphone	IP240	mr3.8.3.3	mr10.5.1.1
Innovaphone	IP22	mr3.8.3.3	mr10.5.1.1
Innovaphone	IP111	mr3.8.3.3	mr10.5.1.1
Panasonic	KX-UT113	mr3.7.1.1	<a href="#">mr10.5.1.1</a>
Panasonic	KX-UT123	mr3.7.1.1	<a href="#">mr10.5.1.1</a>
Panasonic	KX-UT133	mr3.7.1.1	<a href="#">mr10.5.1.1</a>
Panasonic	KX-UT136	mr3.7.1.1	<a href="#">mr10.5.1.1</a>
Panasonic	KX-UT248	mr3.7.1.1	<a href="#">mr10.5.1.1</a>
Panasonic	KX-TGP600	mr5.1.1.1	<a href="#">mr10.5.1.1</a>
Panasonic	KX-HDV330	mr5.1.1.1	<a href="#">mr10.5.1.1</a>
Panasonic	KX-HDV230	mr5.1.1.1	<a href="#">mr10.5.1.1</a>
Panasonic	KX-HDV130	mr5.1.1.1	<a href="#">mr10.5.1.1</a>
Polycom	VVX300	mr5.4.1.1	mr10.5.1.1
Polycom	VVX400	mr5.4.1.1	mr10.5.1.1
Polycom	VVX500	mr5.4.1.1	mr10.5.1.1
SNOM	D715	mr9.1.1.1	-
SNOM	D717	mr9.1.1.1	-
SNOM	D735	mr9.1.1.1	-
SNOM	D785	mr9.1.1.1	-
SNOM	D862	mr11.5.1.1	-
SNOM	D865	mr11.5.1.1	-
SNOM	M900	mr9.1.1.1	-
SNOM	M65	mr9.1.1.1	-
SNOM	M70	mr9.1.1.1	-
SNOM	M80	mr9.1.1.1	-
SNOM	M85	mr9.1.1.1	-
SNOM	M90	mr9.1.1.1	-
SNOM	A190 (no uaCSTA)	mr9.1.1.1	-
Yealink	CP860	mr5.2.1.1	<a href="#">mr11.5.1.1</a>
Yealink	SIP-T19P	mr3.7.1.1	<a href="#">mr10.5.1.1</a>
Yealink	SIP-T20P	mr3.7.1.1	<a href="#">mr10.5.1.1</a>

Vendor	Model	Available from release	Deprecated from release
Yealink	SIP-T21P	mr3.7.1.1	<a href="#">mr10.5.1.1</a>
Yealink	SIP-T22P	mr3.7.1.1	<a href="#">mr10.5.1.1</a>
Yealink	SIP-T23P	mr3.7.1.1	<a href="#">mr11.5.1.1</a>
Yealink	SIP-T23G	mr3.7.1.1	<a href="#">mr11.5.1.1</a>
Yealink	SIP-T26P	mr3.7.1.1	<a href="#">mr10.5.1.1</a>
Yealink	SIP-T28P	mr3.7.1.1	<a href="#">mr10.5.1.1</a>
Yealink	SIP-T28P + EXP39	mr3.8.1.1	<a href="#">mr10.5.1.1</a>
Yealink	SIP-T28P + two EXP39	mr3.8.1.1	<a href="#">mr10.5.1.1</a>
Yealink	SIP-T32G	mr3.7.1.1	<a href="#">mr10.5.1.1</a>
Yealink	SIP-T38G	mr3.7.1.1	<a href="#">mr10.5.1.1</a>
Yealink	SIP-T41P	mr3.7.1.1	<a href="#">mr10.5.1.1</a>
Yealink	SIP-T42G	mr3.7.1.1	<a href="#">mr10.5.1.1</a>
Yealink	SIP-T46G	mr3.7.1.1	<a href="#">mr10.5.1.1</a>
Yealink	SIP-T48G	mr3.7.1.1	<a href="#">mr10.5.1.1</a>
Yealink	SIP-T53	mr8.5.1.1	-
Yealink	SIP-T54W	mr8.5.1.1	-
Yealink	SIP-T57W	mr8.5.1.1	-
Yealink	W52P	mr3.7.1.6	<a href="#">mr11.5.1.1</a>

**NOTE**

Deprecated phones are phones for which the device manufacturer has stopped hardware and software support entirely. These are still available for autoprovisioning, but will no longer be supported and potentially removed in a future version of NGCP

**Alcatel-Lucent Enterprise (ALE) Devices**

Model	IPv6	TLS	SRT P	Auto provisionin g	Priva te Line	Shar ed Line	Busy Lam p	Spee d Dial	Forw ard Key	Tran sfer Key	Extension Boards
8008	Y	Y	Y	redirect	1-2	0	1-6	N	N	N	N
8018	Y	Y	Y	redirect	1-2	0	1-6	N	N	N	N
8028	Y	Y	Y	redirect	1-2	0	1-6	N	N	N	N
8058	Y	Y	Y	redirect	1-4	1	1-10	N	N	N	Y
8068	Y	Y	Y	redirect	1-4	1	1-10	N	N	N	Y
8078	Y	Y	Y	redirect	1-4	1	1-10	N	N	N	Y
AOM10	N	N	N	device	1	0	1	Y	N	N	Y
AOM40	N	N	N	device	1	0	1	Y	N	N	Y
AOMEL	N	N	N	device	1	0	1	Y	N	N	Y

Model	IPv6	TLS	SRT P	Auto provisionin g	Priva te Line	Shar ed Line	Busy Lam p	Spee d Dial	Forw ard Key	Tran sfer Key	Extension Boards
M3	Y	Y	Y	redirect	1-8	0	1-20	Y	Y	Y	N
M5	Y	Y	Y	redirect	1-8	0	1-28	Y	Y	Y	N
M7	Y	Y	Y	redirect	1-8	0	1-28	Y	Y	Y	N
M8	Y	Y	Y	redirect	1-9	0	1-36	Y	Y	Y	N
H2P	Y	Y	Y	redirect	1-2	0	0	Y	Y	Y	N
H3G	Y	Y	Y	redirect	1-3	0	1-8	Y	Y	Y	N
H6	Y	Y	Y	redirect	1-4	0	1-12	Y	Y	Y	N

### Audiocodes Devices

Model	IPv6	TLS	S RTP	Auto provisioning	Priva te Line	Shar ed Line	Busy Lam p	Spee d Dial	Forw ard Key	Trans fer Key	Medi ant8 oo
-------	------	-----	-------	-------------------	---------------	--------------	------------	-------------	--------------	---------------	--------------

### Cisco Devices

#### IP Phones

Model	IPv6	TLS	SRT P	Auto provisionin g	Priva te Line	Shar ed Line	Busy Lam p	Spee d Dial	Forw ard Key	Tran sfer Key	Extension Boards
SPA301	N	Y	Y	http	1	1	0	N	N	N	N
SPA303	N	Y	Y	http	1-3	1-3	1-2	N	N	N	N
SPA501G	N	Y	Y	http	1-8	1-8	1-7	N	N	N	N
SPA502G	N	Y	Y	http	1	1	0	N	N	N	N
SPA512G	N	N	Y	http	1	1	0	N	N	N	N
SPA504G	N	Y	Y	http	1-4	1-4	1-3	N	N	N	2
SPA514G	N	N	Y	http	1-4	1-4	1-3	N	N	N	N
SPA508G	N	Y	Y	http	1-8	1-8	1-7	N	N	N	N
SPA509G	N	Y	Y	http	1-12	1-12	1-11	N	N	N	N
SPA525G	N	Y	N	http	1-5	1-5	1-4	N	N	N	N

#### Analog Adapters

Model	IPv6	TLS	S RTP	Auto provisioning	Privat e Line	Share d Line	Busy Lamp	Spee d Dial	Forw ard Key	Trans fer Key
SPA232D	N	Y	Y	http	1-6	0	0	N	N	N
ATA112	Y	Y	Y	http	1-2	0	0	N	N	N

Model	IPv6	TLS	S RTP	Auto provisioning	Private Line	Shared Line	Busy Lamp	Speed Dial	Forward Key	Transfer Key
ATA122	Y	Y	Y	http	1-2	0	0	N	N	N

### Extension Boards

Model	Ports	Buttons	Busy Lamp	Speed Dial	Forward Key	Transfer Key	Supported phones
SPA500S	2	32	1-32	N	N	N	SPA500

### Grandstream Devices

#### Analog Adapters

Model	IPv6	TLS	S RTP	Auto provisioning	Private Line	Shared Line	Busy Lamp	Speed Dial	Forward Key	Transfer Key
HT814	N	Y	Y	redirect	4	N	N	N	N	N
GXW-4008	N	Y	Y	redirect	8	N	N	N	N	N
GXW-4216	N	Y	Y	redirect	16	N	N	N	N	N

### Innovaphone Devices

#### IP Phones

Model	IPv6	TLS	S RTP	Auto provisioning	Private Line	Shared Line	Busy Lamp	Speed Dial	Forward Key	Transfer Key	Extension Boards
IP232	N	Y	Y	dhcp	1	0	1-16	N	N	N	2
IP222	N	Y	Y	dhcp	1	0	1-16	N	N	N	2
IP240	N	N	N	dhcp	1	0	1-15	N	N	N	2
IP111	N	Y	Y	dhcp	1	0	1-16	N	N	N	0

#### Analog Adapters

Model	IPv6	TLS	S RTP	Auto provisioning	Private Line	Shared Line	Busy Lamp	Speed Dial	Forward Key	Transfer Key
IP22	N	Y	Y	dhcp	1	0	0	N	N	N

### Extension Boards

Model	Ports	Buttons	Busy Lamp	Speed Dial	Forward Key	Transfer Key	Supported phones
IP2X2X	2	64	1-32	N	N	N	IP2x2

Model	Ports	Buttons	Busy Lamp	Speed Dial	Forward Key	Transfer Key	Supported phones
IP230-X	2	30	1-30	N	N	N	IP230

## Panasonic Devices

### IP Phones

Model	IPv6	TLS	SRT P	Auto provisioning	Private Line	Shared Line	Busy Lamp	Speed Dial	Forward Key	Transfer Key	Extension Boards
KX-UT113	N	N	N	redirect	1-2	1-2	0	N	N	N	N
KX-UT123	N	N	N	redirect	1-2	1-2	0	N	N	N	N
KX-UT133	N	N	N	redirect	1-4	1-4	1-23	N	N	N	N
KX-UT136	N	N	N	redirect	1-4	1-4	1-23	N	N	N	N
KX-UT248	N	N	Y	redirect	1-6	1-6	1-23	N	N	N	N
KX-TGP600	Y	Y	Y	redirect	1-8	N	N	N	N	N	N
KX-HDV330	Y	Y	Y	redirect	1-12	Y	Y	N	N	N	N
KX-HDV230	Y	Y	Y	redirect	1-6	Y	Y	N	N	N	N
KX-HDV130	Y	Y	Y	redirect	1-2	Y	Y	N	N	N	N

## Polycom Devices

### IP Phones

Model	IPv6	TLS	SRT P	Auto provisioning	Private Line	Shared Line	Busy Lamp	Speed Dial	Forward Key	Transfer Key	Extension Boards
VVX300	N	N	Y	redirect	1-6	1-6	Y	N	N	N	N
VVX400	N	N	Y	redirect	1-12	1-12	Y	N	N	N	N
VVX500	N	N	Y	redirect	1-12	1-12	Y	N	N	N	N

## SNOM Devices

### IP Phones

Model	IPv6	TLS	SRT P	Auto provisioning	Private Line	Shared Line	Busy Lamp	Speed Dial	Forward Key	Transfer Key	Extension Boards
D715	Y	Y	Y	redirect	1-4	N	Y	Y	Y	Y	Y
D717	Y	Y	Y	redirect	1-6	N	Y	Y	Y	Y	Y
D735	Y	Y	Y	redirect	1-12	N	Y	Y	Y	Y	Y
D785	Y	Y	Y	redirect	1-12	N	Y	Y	Y	Y	Y

Model	IPv6	TLS	SRT P	Auto provisioning	Private Line	Shared Line	Busy Lamp	Speed Dial	Forward Key	Transfer Key	Extension Boards
D862	Y	Y	Y	redirect	1-12	N	Y	Y	Y	Y	Y
D865	Y	Y	Y	redirect	1-8	N	Y	Y	Y	Y	Y

### Base Stations

Model	IPv6	TLS	SRT P	Auto provisioning	Private Line	Shared Line	Busy Lamp	Speed Dial	Forward Key	Transfer Key	Extension Boards
M900	Y	Y	Y	redirect	1-4	N	N	N	N	N	N

### Handsets and Headsets

Model	IPv6	TLS	SRT P	Auto provisioning	Private Line	Shared Line	Busy Lamp	Speed Dial	Forward Key	Transfer Key	Extension Boards
M65	Y	Y	Y	redirect	1	N	N	N	N	N	N
M70	Y	Y	Y	redirect	1	N	N	N	N	N	N
M80	Y	Y	Y	redirect	1	N	N	N	N	N	N
M85	Y	Y	Y	redirect	1	N	N	N	N	N	N
M90	Y	Y	Y	redirect	1	N	N	N	N	N	N
A190	Y	Y	Y	redirect	1	N	N	N	N	N	N

### Yealink Devices

#### IP Phones

Model	IPv6	TLS	SRT P	Auto provisioning	Private Line	Shared Line	Busy Lamp	Speed Dial	Forward Key	Transfer Key	Extension Boards
CP860	Y	Y	Y	redirect	1	N	N	N	N	N	N
SIP-T19P	Y	Y	Y	redirect	1	1	0	N	N	N	N
SIP-T20P	Y	Y	Y	redirect	1	1	0	N	N	N	N
SIP-T21P	Y	Y	Y	redirect	1-2	1-2	1	Y	Y	Y	N
SIP-T22P	Y	Y	Y	redirect	1-3	1-3	1-2	Y	Y	Y	N
SIP-T23P	Y	Y	Y	redirect	1-3	1-3	1-2	Y	Y	Y	N
SIP-T23G	Y	Y	Y	redirect	1-3	1-3	1-2	Y	Y	Y	N
SIP-T26P	Y	Y	Y	redirect	1-3	1-3	1-12	Y	Y	Y	N
SIP-T28P	Y	Y	Y	redirect	1-6	1-6	1-15	Y	Y	Y	2
SIP-T32G	Y	Y	Y	redirect	1-3	1-3	1-2	Y	Y	Y	N

Model	IPv6	TLS	SRT P	Auto provisioning	Private Line	Shared Line	Busy Lamp	Speed Dial	Forward Key	Transfer Key	Extension Boards
SIP-T38G	Y	Y	Y	redirect	1-6	1-6	1-15	Y	Y	Y	N
SIP-T41P	Y	Y	Y	redirect	1-3	1-3	1-14	Y	Y	Y	N
SIP-T42G	Y	Y	Y	redirect	1-3	1-3	1-14	Y	Y	Y	N
SIP-T46G	Y	Y	Y	redirect	1-6	1-6	1-26	Y	Y	Y	N
SIP-T48G	Y	Y	Y	redirect	1-6	1-6	1-28	Y	Y	Y	N
W52P	N	Y	Y	redirect	1-5	1-5	0	N	N	N	N

### 8.1.17. Phone features

#### Cisco phones

##### SPA301

##### 1) Soft keys

Not available.

##### 2) Hard keys

- vm
- hold/unhold

##### 3) Line keys

Not available.

##### 4) VSC

- directed pickup
- park/unpark

##### SPA303

##### 1) Soft keys

Idle:

redial	lcr	dir	dnd >
< cfwd	unpark		

Idle with missed calls:

lcr			miss
-----	--	--	------

Call:

hold	endCall	conf	xfer >
< bxfer	park		

**Call on hold:**

resume	endCall	newCall	redial >
< dir	cfwd	dnd	

**Ringing:**

answer	ignore		
--------	--------	--	--

**2) Hard keys**

- vm
- hold/unhold

**3) Line keys**

- BLF monitoring
- directed pickup

**4) VSC**

- directed pickup

**SPA501G****1) Soft keys****Idle:**

redial	lcr	dir	dnd >
< cfwd	unpark		

**Idle with missed calls:**

lcr			miss
-----	--	--	------

**Call:**

hold/resume	endCall	conf	xfer >
< bxfer	park		

**Call on hold:**

resume	endCall	newCall	redial >
< dir	cfwd	dnd	

**Ringling:**

answer	reject		
--------	--------	--	--

**2) Hard keys**

- vm
- hold/unhold

**3) Line keys**

- BLF monitoring
- directed pickup

**4) VSC**

- directed pickup

**SPA502G****1) Soft keys****Idle:**

redial	lcr	dir	dnd >
< cfwd	unpark		

**Idle with missed calls:**

lcr			miss
-----	--	--	------

**Call:**

hold/resume	endCall	conf	xfer >
< bxfer	park		

**Call on hold:**

resume	endCall	newCall	redial >
< dir	cfwd	dnd	

**Ringling:**

answer	reject		
--------	--------	--	--

**2) Hard keys**

- vm
- hold/unhold

**3) Line keys**

Not available.

**4) VSC**

- directed pickup

**SPA504G****1) Soft keys****Idle:**

redial	lcr	dir	dnd >
< cfwd	unpark		

**Idle with missed calls:**

lcr			miss
-----	--	--	------

**Call:**

hold/resume	endCall	conf	xfer >
< bxfer	park		

**Call on hold:**

resume	endCall	newCall	redial >
< dir	cfwd	dnd	

**Ringing:**

answer	reject		
--------	--------	--	--

**2) Hard keys**

- vm
- hold/unhold

**3) Line keys**

- BLF monitoring
- directed pickup

**4) VSC**

- directed pickup

**SPA512G**

**1) Soft keys****Idle:**

redial	lcr	dir	dnd >
< cfwd	unpark		

**Idle with missed calls:**

lcr			miss
-----	--	--	------

**Call:**

hold/resume	endCall	conf	xfer >
< bxfer	park		

**Call on hold:**

resume	endCall	newCall	redial >
< dir	cfwd	dnd	

**Ringing:**

answer	reject		
--------	--------	--	--

**2) Hard keys**

- vm
- hold/unhold

**3) Line keys**

Not available.

**4) VSC**

- directed pickup

**SPA514G****1) Soft keys****Idle:**

redial	lcr	dir	dnd >
< cfwd	unpark		

**Idle with missed calls:**

lcr			miss
-----	--	--	------

**Call:**

hold/resume	endCall	conf	xfer >
< bxfer	park		

**Call on hold:**

resume	endCall	newCall	redial >
< dir	cfwd	dnd	

**Ringing:**

answer	reject		
--------	--------	--	--

**2) Hard keys**

- vm
- hold/unhold

**3) Line keys**

- BLF monitoring
- directed pickup

**4) VSC**

- directed pickup

**SPA509G****1) Soft keys****Idle:**

redial	lcr	dir	dnd >
< cfwd	unpark		

**Idle with missed calls:**

lcr			miss
-----	--	--	------

**Call:**

hold/resume	endCall	conf	xfer >
< bxfer	park		

**Call on hold:**

resume	endCall	newCall	redial >
< dir	cfwd	dnd	

**Ringing:**

answer	reject		
--------	--------	--	--

**2) Hard keys**

- vm
- hold/unhold

**3) Line keys**

- BLF monitoring
- directed pickup

**4) VSC**

- directed pickup

**SPA508G****1) Soft keys****Idle:**

redial	lcr	dir	dnd >
< cfwd	unpark		

**Idle with missed calls:**

lcr			miss
-----	--	--	------

**Call:**

hold/resume	endCall	conf	xfer >
< bxfer	park		

**Call on hold:**

resume	endCall	newCall	redial >
< dir	cfwd	dnd	

**Ringing:**

answer	reject		
--------	--------	--	--

**2) Hard keys**

- vm
- hold/unhold

### 3) Line keys

- BLF monitoring
- directed pickup

### 4) VSC

- directed pickup

## SPA525G

### 1) Soft keys

#### Idle:

Redial	call Rtn	Directory	DND >
< Forward	Unpark		

#### Idle with missed calls:

Call Rtn			Miss
----------	--	--	------

#### Call:

Hold	End Call	Conf	Transfer >
BlindXfer	Park		

#### Call on hold:

Resume	EndCall	EewCall	Redial >
< Directory	Forward	DND	

#### Ringling:

Answer	Ignore		
--------	--------	--	--

### 2) Hard keys

- vm
- hold/unhold

### 3) Line keys

- BLF monitoring
- directed pickup

**4) VSC**

- directed pickup

**Yealink phones****T19P****1) Soft keys****Idle:**

History		DND	Menu
---------	--	-----	------

**Idle with missed calls:**

Exit			View
------	--	--	------

**Call:**

Tran	Hold	Conf	Cancel
------	------	------	--------

**Call on hold:**

Tran	Resume	NewCall	Cancel
------	--------	---------	--------

**Ringing:**

Answer	FWD	Silence	Reject
--------	-----	---------	--------

**2) Hard keys**

- vm
- redial
- transfer

**3) Line keys**

Not available.

**4) VSC**

- transfer park
- directed pick up
- park/unpark

**T20P****1) Soft keys****Idle:**

History		DND	Menu
---------	--	-----	------

**Idle with missed calls:**

Exit			View
------	--	--	------

**Call:**

Tran	Hold	Conf	Cancel
------	------	------	--------

**Call on hold:**

Tran	Resume	NewCall	Cancel
------	--------	---------	--------

**Ringing:**

Answer	FWD	Silence	Reject
--------	-----	---------	--------

**2) Hard keys**

- vm
- redial
- transfer

**3) Line keys**

- BLF monitoring
- directed pickup
- speed dial
- forward
- transfer

**4) VSC**

- transfer park
- park/unpark

**T21P****1) Soft keys****Idle:**

History		DND	Menu
---------	--	-----	------

**Idle with missed calls:**

Exit			View
------	--	--	------

**Call:**

Tran	Hold	Conf	Cancel
------	------	------	--------

**Call on hold:**

Tran	Resume	NewCall	Cancel
------	--------	---------	--------

**Ringing:**

Answer	FWD	Silence	Reject
--------	-----	---------	--------

**2) Hard keys**

- vm
- redial
- transfer

**3) Line keys**

- BLF monitoring
- directed pickup
- speed dial
- forward
- transfer

**4) VSC**

- transfer park
- park/unpark

**T22P****1) Soft keys****Idle:**

History		DND	Menu
---------	--	-----	------

**Idle with missed calls:**

Exit			View
------	--	--	------

**Call:**

Tran	Hold	Conf	Cancel
------	------	------	--------

**Call on hold:**

Tran	Resume	NewCall	Cancel
------	--------	---------	--------

**Ringing:**

Answer	FWD	Silence	Reject
--------	-----	---------	--------

**2) Hard keys**

- vm
- redial
- transfer

**3) Line keys**

- BLF monitoring
- directed pickup
- speed dial
- forward
- transfer

**4) VSC**

- park/unpark
- transfer park

**T23P****1) Soft keys****Idle:**

History		DND	Menu
---------	--	-----	------

**Idle with missed calls:**

Exit			View
------	--	--	------

**Call:**

Tran	Hold	Conf	Cancel
------	------	------	--------

**Call on hold:**

Tran	Resume	NewCall	Cancel
------	--------	---------	--------

**Ringing:**

Answer	FWD	Silence	Reject
--------	-----	---------	--------

**2) Hard keys**

- vm
- redial
- transfer

**3) Line keys**

- BLF monitoring
- directed pickup
- speed dial
- forward
- transfer

**4) VSC**

- park/unpark
- transfer park

**T23G****1) Soft keys****Idle:**

History	Dir	DND	Menu
---------	-----	-----	------

**Idle with missed calls:**

Exit			View
------	--	--	------

**Call:**

Tran	Hold	Conf	EndCall
------	------	------	---------

**Call on hold:**

Tran	Resume	NewCall	EndCall
------	--------	---------	---------

**Ringing:**

Answer	FWD		Reject
--------	-----	--	--------

**2) Hard keys**

- vm
- redial
- transfer

**3) Line keys**

- BLF monitoring
- directed pickup
- speed dial
- forward
- transfer

**4) VSC**

- unpark
- transfer park

**T26P****1) Soft keys****Idle:**

History		DND	Menu
---------	--	-----	------

**Idle with missed calls:**

Exit			View
------	--	--	------

**Call:**

Tran	Hold	Conf	Cancel
------	------	------	--------

**Call on hold:**

Tran	Resume	NewCall	Cancel
------	--------	---------	--------

**Ringing:**

Answer	FWD	Silence	Reject
--------	-----	---------	--------

**2) Hard keys**

- vm
- redial
- transfer

**3) Line keys**

- BLF monitoring
- directed pickup
- speed dial

- forward
- transfer

#### 4) VSC

- unpark
- transfer park

#### T28P

##### 1) Soft keys

###### Idle:

History		DND	Menu
---------	--	-----	------

###### Idle with missed calls:

Exit			View
------	--	--	------

###### Call:

Tran	Hold	Conf	Cancel
------	------	------	--------

###### Call on hold:

Tran	Resume	NewCall	Cancel
------	--------	---------	--------

###### Ringling:

Answer	FWD	Silence	Reject
--------	-----	---------	--------

##### 2) Hard keys

- vm
- redial
- transfer

##### 3) Line keys

- BLF monitoring
- directed pickup
- speed dial
- forward
- transfer

#### 4) VSC

- park/unpark

- transfer park

## T32G

### 1) Soft keys

#### Idle:

History		DND	Menu
---------	--	-----	------

#### Idle with missed calls:

Exit			View
------	--	--	------

#### Call:

Tran	Hold	Conf	Cancel
------	------	------	--------

#### Call on hold:

Tran	Resume	NewCall	Cancel
------	--------	---------	--------

#### Ringing:

Answer	FWD	Silence	Reject
--------	-----	---------	--------

### 2) Hard keys

- vm
- redial
- transfer

### 3) Line keys

- BLF monitoring
- directed pickup
- speed dial
- forward
- transfer

### 4) VSC

- unpark
- transfer park

## T38G

### 1) Soft keys

**Idle:**

History		DND	Menu
---------	--	-----	------

**Idle with missed calls:**

Exit			View
------	--	--	------

**Call:**

Tran	Hold	Conf	Cancel
------	------	------	--------

**Call on hold:**

Tran	Resume	NewCall	Cancel
------	--------	---------	--------

**Ringling:**

Answer	FWD	Silence	Reject
--------	-----	---------	--------

**2) Hard keys**

- vm
- redial
- transfer

**3) Line keys**

- BLF monitoring
- directed pickup
- speed dial
- forward
- transfer

**4) VSC**

- unpark
- transfer park

**T41P****1) Soft keys****Idle:**

History		DND	Menu
---------	--	-----	------

**Idle with missed calls:**

Exit			View
------	--	--	------

**Call:**

Tran	Hold	Conf	Cancel
------	------	------	--------

**Call on hold:**

Tran	Resume	NewCall	Cancel
------	--------	---------	--------

**Ringing:**

Answer	FWD	Silence	Reject
--------	-----	---------	--------

**2) Hard keys**

- vm
- redial
- transfer

**3) Line keys**

- BLF monitoring
- directed pickup
- speed dial
- forward
- transfer

**4) VSC**

- park/unpark
- transfer park

**T42G****1) Soft keys****Idle:**

History		DND	Menu
---------	--	-----	------

**Idle with missed calls:**

Exit			View
------	--	--	------

**Call:**

Tran	Hold	Conf	Cancel
------	------	------	--------

**Call on hold:**

Tran	Resume	NewCall	Cancel
------	--------	---------	--------

**Ringing:**

Answer	FWD	Silence	Reject
--------	-----	---------	--------

**2) Hard keys**

- vm
- redial
- transfer

**3) Line keys**

- BLF monitoring
- directed pickup
- speed dial
- forward
- transfer

**4) VSC**

- park/unpark
- transfer park

**T46G****1) Soft keys****Idle:**

History		DND	Menu
---------	--	-----	------

**Idle with missed calls:**

Exit			View
------	--	--	------

**Call:**

Tran	Hold	Conf	Cancel
------	------	------	--------

**Call on hold:**

Tran	Resume	NewCall	Cancel
------	--------	---------	--------

**Ringing:**

Answer	FWD	Silence	Reject
--------	-----	---------	--------

## 2) Hard keys

- vm
- redial
- transfer

## 3) Line keys

- BLF monitoring
- directed pickup
- speed dial
- forward
- transfer

## 4) VSC

- park/unpark
- transfer park

## T48G

### 1) Soft keys

#### Idle:

History		DND	Menu
---------	--	-----	------

#### Idle with missed calls:

Exit			View
------	--	--	------

#### Call:

Tran	Hold	Conf	Cancel
------	------	------	--------

#### Call on hold:

Tran	Resume	NewCall	Cancel
------	--------	---------	--------

#### Ringing:

Answer	FWD	Silence	Reject
--------	-----	---------	--------

## 2) Hard keys

- vm

- redial
- transfer

### 3) Line keys

- BLF monitoring
- directed pickup
- speed dial
- forward
- transfer

### 4) VSC

- park/unpark
- transfer park

### W52P

#### 1) Soft keys

##### Idle:

History	Line
---------	------

##### Idle with missed calls:

Exit	View
------	------

##### Call:

Ext. Call	Options
-----------	---------

##### Call on hold:

Resume	Line
--------	------

##### Ringing:

Accept	
--------	--

#### 2) Hard keys

- vm
- redirect

#### 3) VSC

- park/unpark
- transfer park

## Panasonic phones

### *KX-UT113*

#### 1) Soft keys

##### Idle:

Settings	Call Log	Phone book	
----------	----------	------------	--

##### Call:

Blind		Phone book	
-------	--	------------	--

##### Call on hold:

	Call Log	Phone book	
--	----------	------------	--

##### Ringing:

Answer		Reject	
--------	--	--------	--

#### 2) Hard keys

- vm
- forward/dnd
- hold/unhold
- redial
- recall
- transfer
- conf

#### 3) Line keys

Not available.

#### 4) VSC

- park/unpark
- transfer park

### *KX-UT123*

#### 1) Soft keys

##### Idle:

Settings	Call Log	Phone book	
----------	----------	------------	--

**Call:**

Blind		Phone book	
-------	--	------------	--

**Call on hold:**

	Call Log	Phone book	
--	----------	------------	--

**Ringing:**

Answer		Reject	
--------	--	--------	--

**2) Hard keys**

- vm
- forward/dnd
- hold/unhold
- redial
- recall
- transfer
- conf

**3) Line keys**

Not available.

**4) VSC**

- park/unpark
- transfer park

***KX-UT133*****1) Soft keys****Idle:**

Settings	Call Log	Phone book	
----------	----------	------------	--

**Call:**

Blind		Phone book	
-------	--	------------	--

**Call on hold:**

	Call Log	Phone book	
--	----------	------------	--

**Ringing:**

Answer		Reject	
--------	--	--------	--

## 2) Hard keys

- vm
- forward/dnd
- hold/unhold
- redial
- recall
- transfer
- conf

## 3) Line keys

- BLF monitoring
- directed pickup

## 4) VSC

- unpark
- transfer park

## *KX-UT136*

### 1) Soft keys

#### Idle:

Settings	Call Log	Phone book	
----------	----------	------------	--

#### Call:

Blind		Phone book	
-------	--	------------	--

#### Call on hold:

	Call Log	Phone book	
--	----------	------------	--

#### Ringling:

Answer		Reject	
--------	--	--------	--

## 2) Hard keys

- vm
- forward/dnd
- hold/unhold

- redial
- recall
- transfer
- conf

### 3) Line keys

- BLF monitoring
- directed pickup

### 4) VSC

- park/unpark
- transfer park

## ***KX-UT248***

### 1) Soft keys

#### Idle:

Settings	Call Log	Phone book	
----------	----------	------------	--

#### Call:

Blind		Phone book	
-------	--	------------	--

#### Call on hold:

	Call Log	Phone book	
--	----------	------------	--

#### Ringing:

Answer		Reject	
--------	--	--------	--

### 2) Hard keys

- vm
- forward/dnd
- hold/unhold
- redial
- recall
- transfer
- conf

### 3) Line keys

- BLF monitoring

- directed pickup

#### 4) VSC

- park/unpark
- transfer park

### Innovaphone

#### IP222

##### 1) Soft keys

###### Idle:

Setup	All Calls	Home	Calls	My favorites	Phonebook
-------	-----------	------	-------	--------------	-----------

###### Call:

Hold	Transfer	Park	Cancel
------	----------	------	--------

###### Call on hold:

Resume	Transfer	Park	Cancel
--------	----------	------	--------

###### Ringing:

Answer	Transfer	Silence	Reject
--------	----------	---------	--------

##### 2) Hard keys

- hold
- redial

##### 3) Line keys

- BLF monitoring

#### 4) VSC

- unpark
- transfer park

#### IP232

##### 1) Soft keys

###### Idle:

Setup	All Calls	Home	Calls	My favorites	Phonebook
-------	-----------	------	-------	--------------	-----------

**Call:**

Hold	Transfer	Park	Cancel
------	----------	------	--------

**Call on hold:**

Resume	Transfer	Park	Cancel
--------	----------	------	--------

**Ringling:**

Answer	Transfer	Silence	Reject
--------	----------	---------	--------

**2) Hard keys**

- hold
- redial

**3) Line keys**

- BLF monitoring

**4) VSC**

- unpark
- transfer park

***IP111*****1) Soft keys****Idle:**

Setup	All Calls	Home	Calls	My favorites	Phonebook
-------	-----------	------	-------	--------------	-----------

**Call:**

Hold	Transfer	Park	Cancel
------	----------	------	--------

**Call on hold:**

Resume	Transfer	Park	Cancel
--------	----------	------	--------

**Ringling:**

Answer	Transfer	Silence	Reject
--------	----------	---------	--------

**2) Hard keys**

- hold
- redial

### 3) Line keys

- BLF monitoring

### 4) VSC

- unpark
- transfer park

## IP240

### 1) Soft keys

Not available.

### 2) Hard keys

- hold
- redial
- conference
- dnd
- forward

### 3) Line keys

- BLF monitoring

### 4) VSC

- transfer park
- unpark

## 8.1.18. Shared line appearance

In PBX environment, shared line appearance is supported for PBX subscribers. In comparison to the private line, subscriber registering for the shared line will, immediately after the successful registration, subscribe for Call-Info event. This subscribe is challenged for authentication and if the credentials are provided, subscriber is notified that the subscription is active. In the respective NOTIFY message, this is reflected in Subscription-State header set to active. NOTIFY also contains information about the status of the shared line in Call-Info header. If the appearance is not used, Call-Info header will describe the state as idle. In the NOTIFY message, this is reflected as "appearance-index=\*;appearance-state=idle".

If there is incoming call to the subscriber, the appearance index is created after the call is accepted and state will be set to active. Call-Info header will contain "appearance-index=1; appearance-state=active". After the call is finished and appearance is not used elsewhere, appearance index is removed and state is set to idle. In the case of outgoing call, subscription to line-seize event is required to be able to dial. Before dialing can be started, SUBSCRIBE to line-seize is sent. Consequently, subscriber receives NOTIFY for line-seize with active subscription state. Call-info subscription is updated accordingly, appearance is created and its state is set to seized. As soon as the call starts ringing, Call-Info status is updated to progressing and line-seize subscription is set to terminated with "reason=noresource" in Subscription-State header. When the call is accepted, Call-Info status is changed to active and set

again to idle when call is finished. Also, the appearance index is removed.

## 8.2. Sipwise sip:phone App (SIP client)

Sipwise provides a commercial Unified Communication Client for full end-to-end integration of voice, video, chat and presence features. The application is called sip:phone and is a mobile app for iOS and Android.

The clients are fully brandable to the customer's corporate identity. They are not part of the standard delivery and need to be licensed separately. This handbook discusses the mobile client in details.

### 8.2.1. Zero Config Launcher

Part of the mobile apps is a mechanism to sign up to the service via a 3rd party website, which is initiated on the login screen and rendered within the app. During the sign-up process, the 3rd party service is supposed to create a new account and subscriber in Sipwise C5 (e.g. automatically via the API) and provide the end user with the access credentials.

The mobile apps come with a zero config mechanism to simplify the end-customer log in using these credentials (especially ruling out the need to manually enter them). It makes it possible to deliver the access credentials via a side channel (e.g. Email, SMS) packed into a URL. The user only clicks the URL, and it automatically launches the app with the correct credentials. The following picture shows the overall workflow.

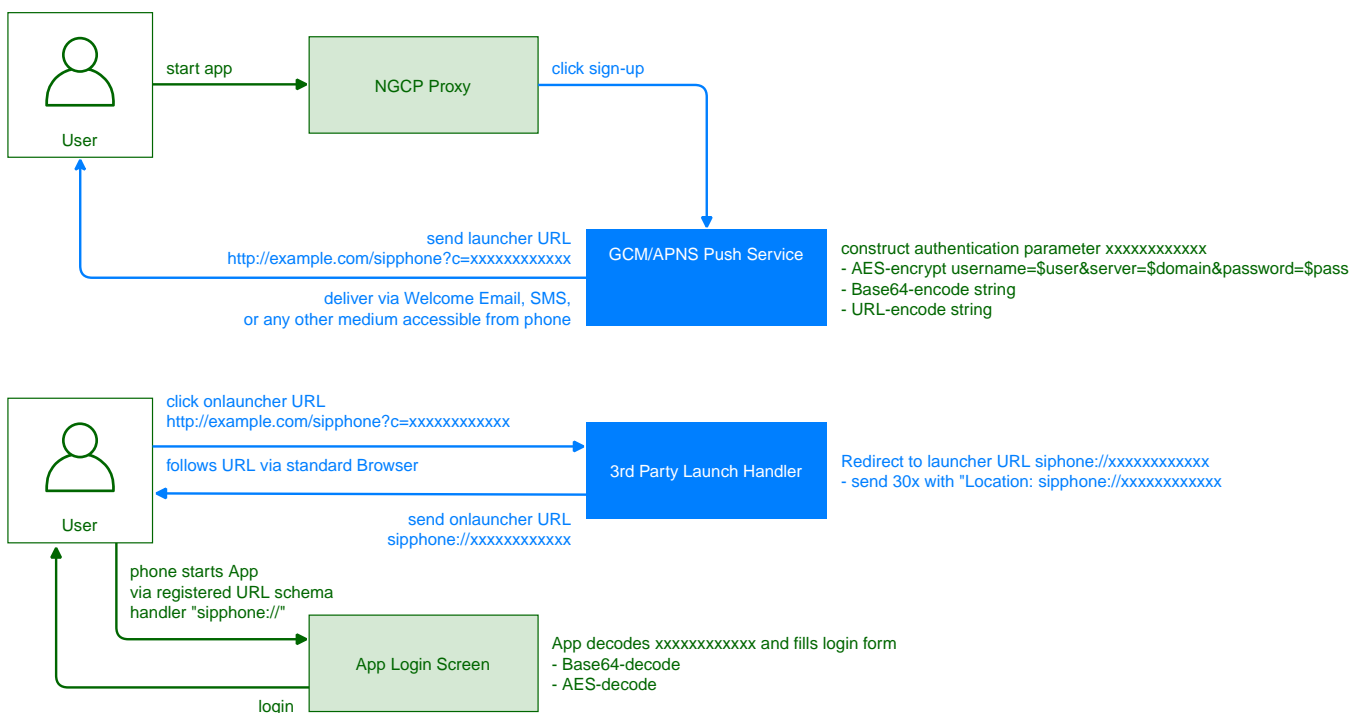

Figure 199. Provisioning Push Workflow

There are two components provided by a 3rd party system. One is the *3rd Party Sign-Up Form*, and the other is the *3rd Party Launch Handler*. The purpose of these components is to allow an end customer to open a link with the access credentials via the sip:phone app.

### 3rd Party Sign-Up Form

The 3rd Party Sign-Up Form is a website the app shows to the end user when they tap the sign-up link on the app *Login Screen*. There, the end customer usually provides their contact details like name, address, phone number and email address, etc. After validation, the website creates an account and a subscriber in Sipwise C5 via the API.

After successfully creating the account and the subscriber, this site needs to construct a specially crafted URL, which is sent back to the end customer via a side channel. Ideally, this channel would be an SMS if you want to verify the end customer's mobile number, or an email if you want to check the email address.

The sip:phone app registers a URL schema handler for URLs starting with sipphone://. If you start such a link, the app performs a Base64 decoding of the string right after the sipphone:// prefix and then decrypts the resulting binary string via AES using the keys defined during the branding step. The resulting string is supposed to be

```
username=$user&server=$domain&password=$password&fsurl=$fsurl&fsttl=$fsttl&country=$country.
```

Therefore, the *3rd Party Sign-Up Form* needs to construct this string using the credentials defined while creating the subscriber via Sipwise C5 API, then encrypt it via AES, and finally perform a Base64 encoding of the result.

The parameters of the string are as follows:

- username: The SIP username for the login (e.g. *testuser*)
- password: The SIP password for the login (e.g. *testpass*)
- server: The server string containing either the IP address or a domain resolving via DNS SRV or A records to the load-balancer IP of the deployment (e.g. *sip.example.org*)
- fsurl: The filesharing URL for the apps to upload data (e.g. <https://sip.example.org:1446/rtc/fileshare/uploads>)
- fsttl: The number of seconds a shared file is valid by default (e.g. *1209600* for 14 days)
- country: The ISO country code for the app to normalize phone numbers (e.g. *de* for Germany)

An example Perl code performs encoding of such a string. The AES key and initialization vector (\$key and \$iv) are the standard values of the sip:phone app and should work until you specify other values during the branding process.

```
#!/usr/bin/perl -w
use strict;
use Crypt::Rijndael;
use MIME::Base64;
use URI::Escape;

my $key = 'iBmTdavJ8joPW3HO';
my $iv = 'tw21lQe6cmw3';

my $plain = do { local $/; <> };
# pkcs#5 padding to 16 bytes blocksize
my $pad = 16 - (length $plain) % 16;
```

```

$plain .= pack('C', $pad) x $pad;

my $cipher = Crypt::Rijndael->new(
    $key,
    Crypt::Rijndael::MODE_CBC()
);
$cipher->set_iv($iv);
my $encrypted = $cipher->encrypt($plain);
# store b64-encoded string and print to STDOUT
my $b64 = encode_base64($encrypted, '');
print $b64, "\n";
# print to STDOUT using URL escaping also
print uri_escape($b64), "\n";

```

This snippet takes a string from STDIN, encrypts it via AES, encodes it via Base64 and sends the result to STDOUT. It also writes the second line with the same string, but this time, the URL is escaped. To test it, you would run it as follows on a shell, granted it's stored at /path/to/encrypt.pl.

```

echo -n
'username=testuser&server=example.org&password=testpass&fsurl=https://example.org:1446/rtc/fileshare/uploads&fsttl=3600&country=at' \
| /path/to/encrypt.pl

```

This command would result in the output strings like

```

CI8VN8toaE40w8E40H2rAuFj3Qev9QdLI/Wv/VaBCVK2yNkBZjxE9eafXkkrQfmYdeu01Pqu
S5P40zhUq8Mfjg==

```

and like

```

CI8VN8toaE40w8E40H2rAuFj3Qev9QdLI%2FWv%2FVaBCVK2yNkBZjxE9eafXkkrQfmYdeu0
1PquS5P40zhUq8Mfjg%3D%3D

```

The sip:phone can use the former string to automatically fill in the login form of the Login Screen if started via a Link like

```

sipphone://CI8VN8toaE40w8E40H2rAuFj3Qev9QdLI/Wv/VaBCVK2yNkBZjxE9eafXkkrQ
fmYdeu01PquS5P40zhUq8Mfjg==

```

Here is the same code in PHP.

```

#!/usr/bin/php
<?php
$key = "iBmTdavJ8joPW3H0";
$iv = "tww21lQe6cmywrp3";

```

```

$clear = fgets(STDIN);
$cipher = fnEncrypt($clear, $key, $iv);

echo $cipher, "\n";
echo urlencode($cipher), "\n";

function fnEncrypt($clear, $key, $iv) {
    $pad = 16 - strlen($clear) % 16;
    $clear .= str_repeat(pack('C', $pad), $pad);
    return rtrim(base64_encode(mcrypt_encrypt(
        MCRYPT_RIJNDAEL_128, $key, $clear,
        MCRYPT_MODE_CBC, $iv)), "\0");
}
?>

```

Similar to the Perl code, you can call it like this:

```

echo -n
'username=testuser&server=example.org&password=testpass&fsurl=https://ex
ample.org:1446/rtc/fileshare/uploads&fsttl=3600&country=at' \
| /path/to/encrypt.php

```

However, a URL with the sipphone:// schema is not displayed as a link in an SMS or an Email client and thus can not be clicked by the end customer, so you need to make a detour via a regular http:// URL. To do so, you need a *3rd Party Launch Handler* to trick the phone to open such a link.

Therefore, that the *3rd Party Sign-Up Form* needs to return a link containing a URL pointing to the *3rd Party Launch Handler* and pass the URL escaped string gathered above to the client via an SMS or an Email. Since it is the regular http:// link, it is clickable on the phone and can be launched from virtually any client (SMS, Email, etc.), which correctly renders an HTML link.

A possible SMS sent to the end customer (via the phone number entered in the sign-up form) could, therefore, look as follows (trying to stay below 140 chars).

```

http://example.org/p?c=CI8VN8toaE40w8E40H2rAuFj3Qev9QdLI
%2FWv%2FVaBCVK2yNkBZjxE9eafXkkrQfmYdeu01PquS5P40zhUq8Mfjg%3D%3D to
launch sipphone

```

An HTML Email could look like this:

```

Welcome to Example.org,
<a
href="http://www.example.org/sipphone?c=CI8VN8toaE40w8E40H2rAuFj3Qev9QdL
I
%2FWv%2FVaBCVK2yNkBZjxE9eafXkkrQfmYdeu01PquS5P40zhUq8Mfjg%3D%3D">
click here

```

</a> to log in.

That way, you can do both: verify the contact details of the end customer, and send the end customer the login credentials in a secure manner.

### 3rd Party Launch Handler

The URL `http://www.example.org/sipphone` mentioned above can be any simple script, and its sole purpose is to send back a 301 Moved Permanently or 302 Moved Temporarily with a `Location: sipphone://xxxxxxxxxxxx` header to tell the phone to open this link via the sip:phone app. The `xxxxxxxxxxxx` is the plain (non-URL-escaped) string generated by the above script.

An example CGI script performing this task follows.

```
#!/usr/bin/perl -w
use strict;
use CGI;

my $q = CGI->new;
my $c = $q->param('c');
print CGI::redirect("sipphone://$c");
```

The script takes the URL parameter `c` from the URL `http://www.example.org/sipphone?c=Ci8VN8toaE40w8E4OH2rAuFj3QevgQdLI%2FWv%2FVaBCVK2yNkBJxjEgeafXkkqQfmYdeu01PquS5P40zhUq8Mfjg%3D%3D` crafted above and puts its content into a `Location` header using the `sipphone://` schema, and finally sends a 301 Moved Permanently back to the phone.

The phone follows the redirect by opening the URL using the sip:phone app, which in turn decrypts the content and fills in the login form.

#### NOTE

Future versions of Sipwise C5 will be shipped with this launch handler integrated into the system. Up until and including the version `mr26.0.1`, this script needs to be installed on any webserver manually.

## 8.2.2. Mobile Push Notification

The *mobile push* functionality provides the remote start of a mobile application on incoming calls via the Google FCM or the Apple APNS notification services. It enables you to offer your subscribers a modern and convenient service on mobile devices.

#### CAUTION

Although suspending an application on a phone and waking it up via the mobile push notification service extends battery life, the whole mobile push notification concept is the best effort framework provided by Apple and Google for iOS and Android respectively, and therefore does not guarantee 100% reliability.

### Architecture

If the *mobile push* functionality is enabled and there are no devices registered for a subscriber, the call-flow looks as follows.

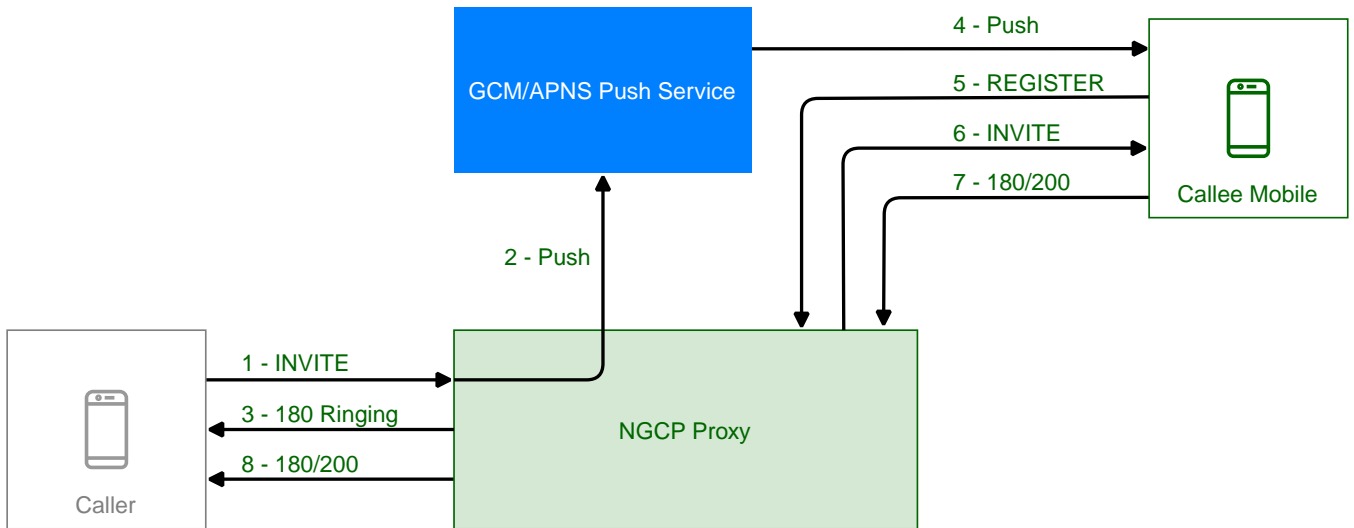

Figure 200. Mobile Push Workflow

1. The caller sends INVITE to the Proxy
2. The callee is offline, the Proxy sends the PUSH request to the GCM/APNS service
3. If configured, Proxy sends a 18x message to the caller to trigger remote ringing
4. The GCM/APNS service delivers the PUSH request to the callee
5. The callee accepts the PUSH request and confirms the mobile application start (unattended on Android), then the mobile application registers at the Proxy
6. The newly received registration triggers in the Proxy a sending of an INVITE to the callee's mobile device
7. The callee accepts the call
8. The response is sent back to the caller. Hence, the call setup is completed

In case of timeout (no registration notification within certain period of time), Proxy rejects the call request with an error.

Sipwise C5 allows to trigger mobile push notifications even if the callee has a device already registered, thus allowing to have a parallel forking to deskphone and mobile phone. In this case if the *mobile push* functionality is enabled the call flow looks as follow.

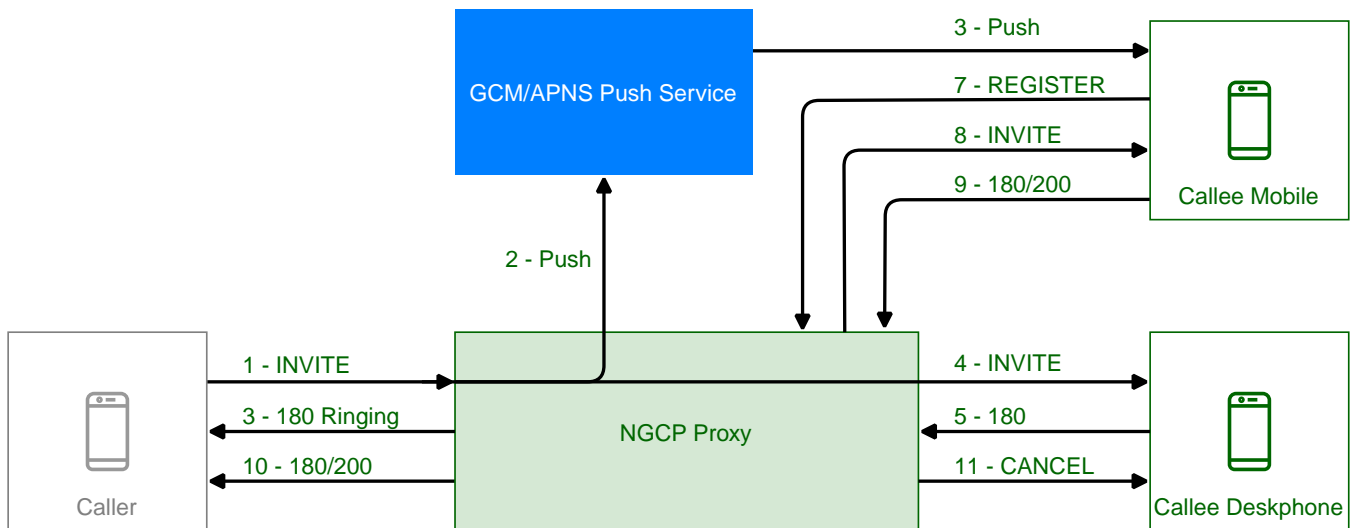

Figure 201. Parallel Mobile Push Workflow

1. The caller sends INVITE to the Proxy
2. The callee is online, the Proxy anyway sends the PUSH request to the GCM/APNS service
3. If configured, Proxy sends a 18x message to the caller to trigger remote ringing
4. At the same time Proxy sends the INVITE to the callee's registered device (deskphone)
5. The GCM/APNS service delivers the PUSH request to the callee
6. The callee's mobile device accepts the PUSH request and confirms the mobile application start (unattended on Android), then the mobile application registers at the Proxy
7. The newly received registration triggers in the Proxy a sending of an INVITE to the callee's mobile device
8. The callee accepts the call using one of its devices
9. The response is sent back to the caller. Hence, the call setup is completed
10. Proxy sends a CANCEL message to the other ringing device

### The Configuration Checklist

Follow this checklist to make sure you have completed all the steps. If steps are not completed in their entirety, the service may not work as expected.

Name	Description	Link
Obtain a trusted SSL certificate from a CA	Required for either application	<a href="#">Obtain the Trusted SSL Certificate</a>
Create an Apple developer account and enable the push notification service	For iOS mobile application	<a href="#">Create an Apple Account and Enable the Push Notification Service</a>
Obtain the Apple certificate for the app	For iOS mobile application	<a href="#">Obtain an Apple SSL Certificate and a Private Key</a>
Obtain the API key for the app from Google	For Android mobile application	<a href="#">Obtain the API Key for the App from Google</a>

Name	Description	Link
Provide the required information to developers	It is required to make beta builds and publish the apps	<a href="#">Provide the Required Information to Developers</a>
Adjust the configuration	Adjust the config.yml file and apply the changes (usually performed by Sipwise)	<a href="#">Adjust Sipwise C5 Configuration (Usually Performed by Sipwise)</a>
Recheck your DNS Zone configuration	Check that the DNS Zone is correctly configured	<a href="#">Recheck Your DNS Zone Configuration</a>
Add DNS SRV records	Create specific DNS SRV records for SIP services	<a href="#">Add SRV Records to DNS</a>
Check NTP configuration	Ensure that all your servers show exact time	<a href="#">Check NTP Configuration</a>
Enable Apple/Google Mobile Push in the Admin Panel	It can be enabled for a domain or separate subscribers	<a href="#">Enable Apple/Google Mobile Push</a>
Configure a mobile application	Check that subscribers can easily install and use your application	<a href="#">Perform Tests</a>

### Obtain the Trusted SSL Certificate

A *trusted* SSL certificate is required, and we suggest obtaining it before starting the configuration.

The mobile application uses respective iOS/Android libraries to establish a secure TLS connection with certain Sipwise C5 services, such as SIP/pushd(https). A *signed* SSL certificate is required to guarantee the security of this connection.

Any Certificate Authority (CA) such as Verisign and others can provide you with the required trusted SSL certificate (a certificate and the key files) which you will use in the configuration below.

### Create an Apple Account and Enable the Push Notification Service

Below is a brief instruction on how to create an Apple account and enable the Push Notification Service in it. You may need to perform additional steps depending on your project.

#### NOTE

You may only create an Apple account (step 1 below) and enroll into the Apple Developer Program (step 2 below) and Sipwise developers will do the rest. Still, you can perform all the steps by yourself.

1. Create an Apple developer account to get the Apple ID for your company. For this, go to <https://developer.apple.com/account>
2. Enroll in the Apple Developer Program. It is required to configure push notifications as you will need a push notification certificate for your App ID, which requires the Apple Developer Program membership. Go to <https://developer.apple.com/programs> for more details.
3. Register an App ID:  
Sign into <https://developer.apple.com/account>.

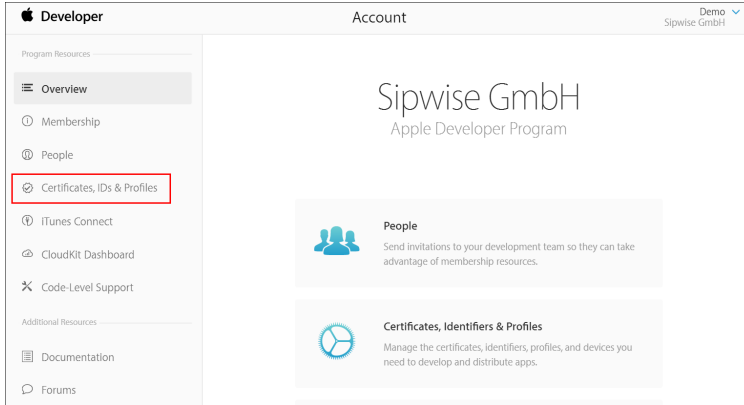

Click *Certificates, IDs & Profiles*.

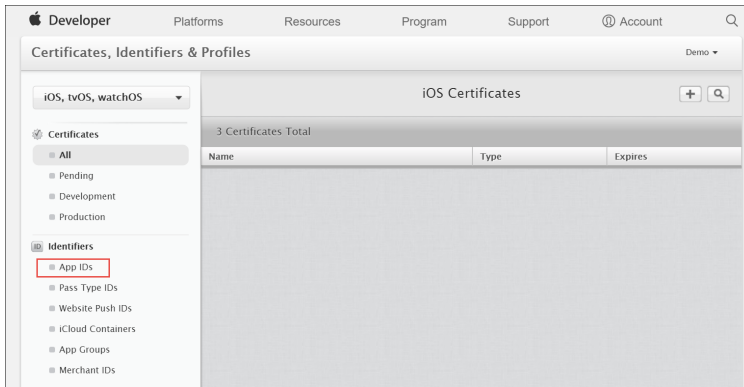

Under *Identifiers*, select *App IDs*.

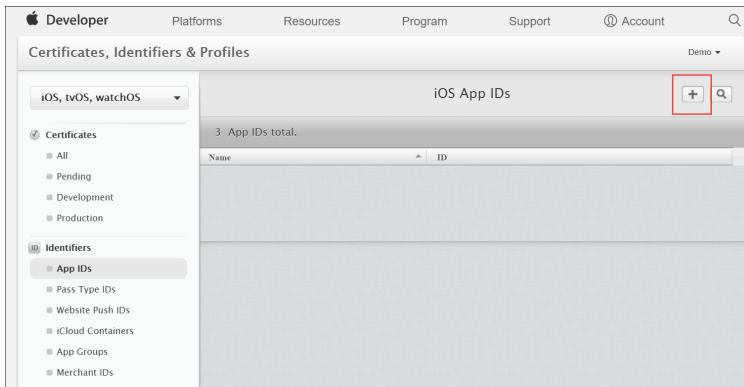

Click the *Add* button (+) in the upper-right corner.

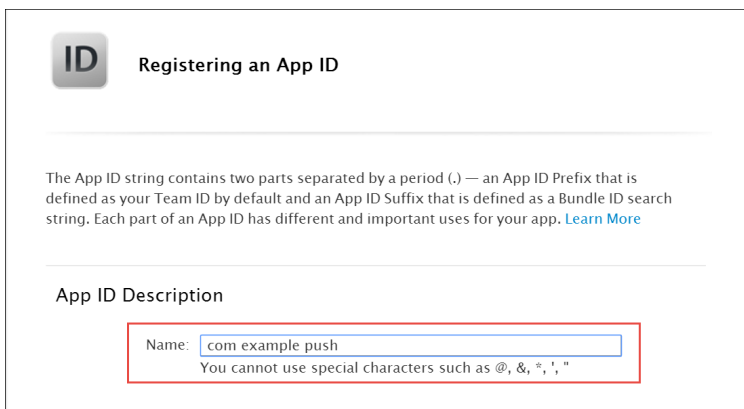

Enter a name for the App ID in the *App ID Description* block. This helps you identify the App ID later.

**App ID Prefix**  
Value: XD7GAT4I26 (Team ID)

**App ID Suffix**

**Explicit App ID**  
If you plan to incorporate app services such as Game Center, In-App Purchase, Data Protection, and iCloud, or want a provisioning profile unique to a single app, you must register an explicit App ID for your app.

To create an explicit App ID, enter a unique string in the Bundle ID field. This string should match the Bundle ID of your app.

Bundle ID:   
We recommend using a reverse-domain name style string (i.e., com.domainname.appname). It cannot contain an asterisk (\*).

**Wildcard App ID**  
This allows you to use a single App ID to match multiple apps. To create a wildcard App ID, enter an asterisk (\*) as the last digit in the Bundle ID field.

Select *Explicit App ID* and enter the app's bundle ID in the *Bundle ID* field. Note that an explicit App ID exactly matches the bundle ID of an app you are building — for example, com.example.push. An explicit App ID can *not* contain an asterisk (\*).

**App Services**  
Select the services you would like to enable in your app. You can edit your choices after this App ID has been registered.

Enable Services:  App Groups  
 App Groups Extensions  
 App Groups Extensions (Background)

---

In-App Purchase  
 Inter-App Audio  
 Wallet  
 **Push Notifications**  
 Personal VPN

In the App Services section enable Push Notifications. Click *Continue* to submit the form

## ID Confirm your App ID.

To complete the registration of this App ID, make sure your App ID information is correct, and click the submit button.

App ID Description: **com example push**

Identifier: **XD7GAT4I26**

Data Protection:  Disabled

Game Center:  Enabled

iCloud:  Disabled

In-App Purchase:  Enabled

Inter-App Audio:  Disabled

Passbook:  Disabled

Push Notifications:  Enabled

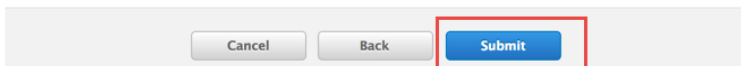

Click *Submit* to create the App ID.

## Obtain an Apple SSL Certificate and a Private Key

1. Create a CSR (Certificate Signing Request):

Sign into <https://developer.apple.com/account/ios/certificate>.



Click the *Add* button (+) in the upper-right corner.

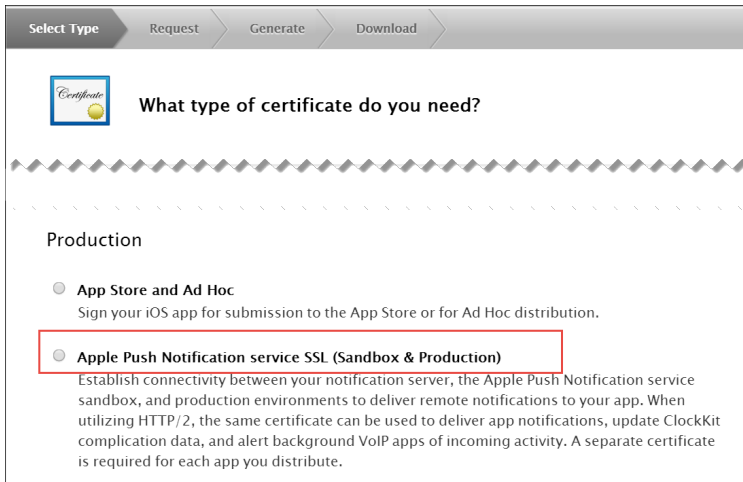

Select *Apple Push Notification service SSL (Sandbox & Production)* as the certificate type and click *Continue*.

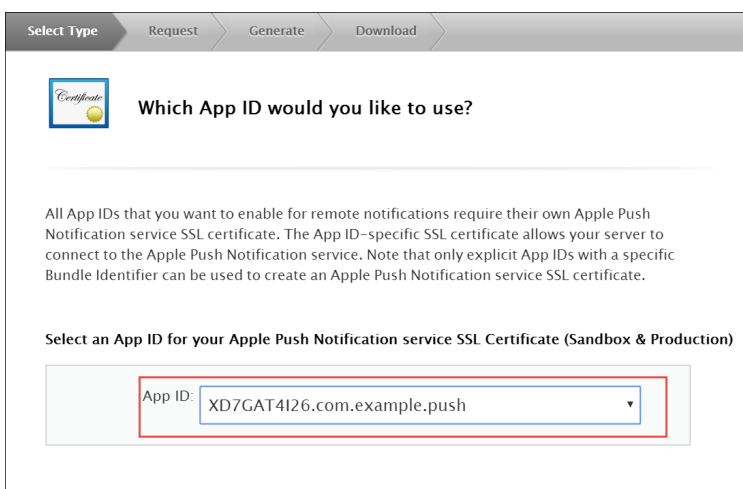

Select your App ID and click *Continue*.

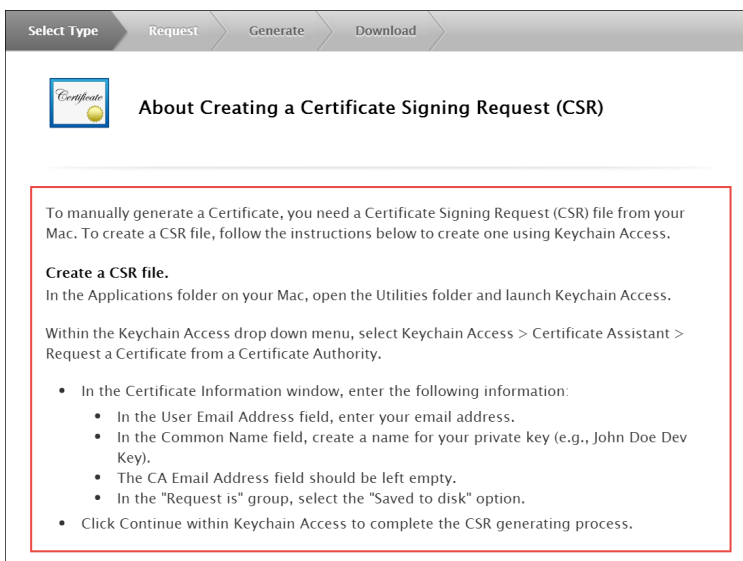

Read the information about creating a CSR.

Follow the instructions to create a CSR using Keychain Access in MAC.

**NOTE**

If you do not have access to a Mac, you can still create a CSR in Linux or Windows using OpenSSL, for example.

## 2. Get the Certificate and Private Key

When you have the CSR file return to the browser and click *Continue*.

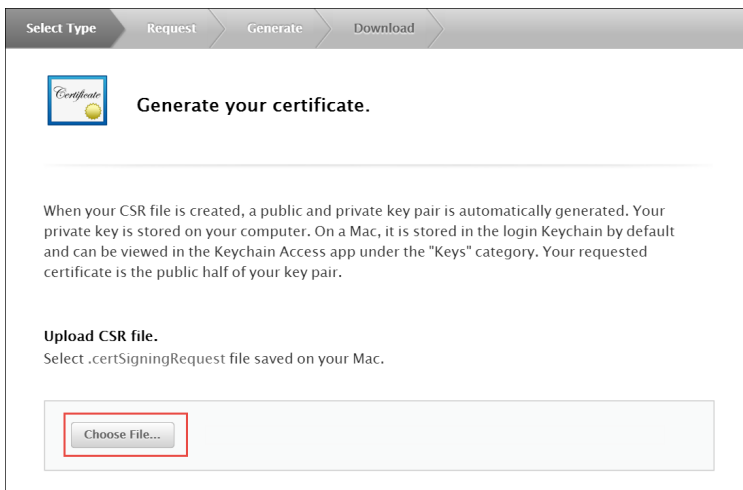

Click *Choose File...* in your browser.

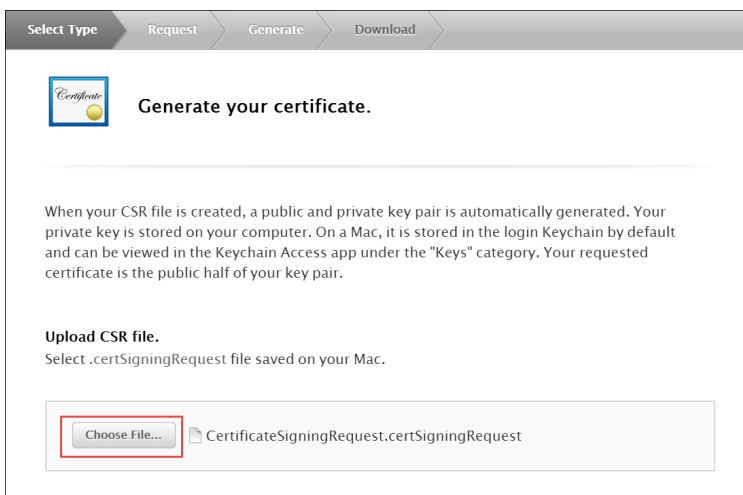

Select the CSR file you just created and saved and click *Continue*.

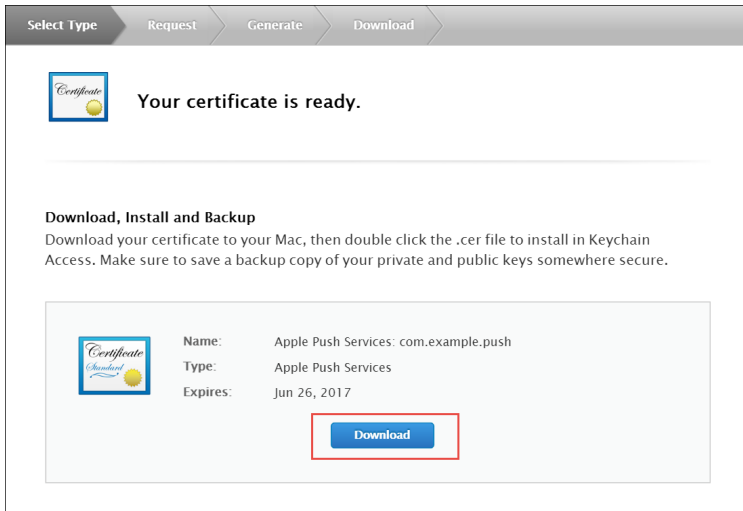

Click *Download* to download the certificate (give it the **aps.cer** name).

Open the downloaded certificate file (it should automatically be opened in Keychain Access, otherwise open it manually in Keychain Access).

Find the certificate you just opened/imported in Keychain Access.

Expand the certificate to show the Private Key.

Select only the Private Key portion of the certificate, right-click on it and select *Export "Common Name"...* from the menu.

Choose a location (e.g. Desktop) and filename to export the .p12 file to and click *Save*.

**Optionally** pick a password for the .p12 file to protect its private key contents and click *OK*. (You will then need to enter your log-in password to permit the export).

### 3. Generate a PEM file from the p12 file:

Open up your terminal and run the following commands to create a PEM file from the p12 file (If you input a password for the p12 file, you will need to enter it here):

```
cd ~/Desktop
openssl x509 -in aps.cer -inform der -out PushChatCert.pem
openssl pkcs12 -in PushChatCert.p12 -out PushCertificate.pem -nodes
-clcerts
openssl pkcs12 -nocerts -out PushChatKey.pem -in PushChatKey.p12
```

## Obtain the API Key for the App from Google

You can use Google Firebase Cloud Messaging (FCM) to send push notifications to your subscribers with Android-based mobile devices. Google Cloud Messaging is a free service that acts as an intermediary between Sipwise C5 and devices of your subscribers. Google's Cloud Connection Server (CCS), a part of GCP, manages the persistent connections with mobile devices to deliver your push notifications.

While communicating with CCS, Sipwise C5 identifies itself using an API key. To get it, follow the steps below.

1. Create a new project in the Google APIs Console page. For this go to

code.google.com/apis/console.

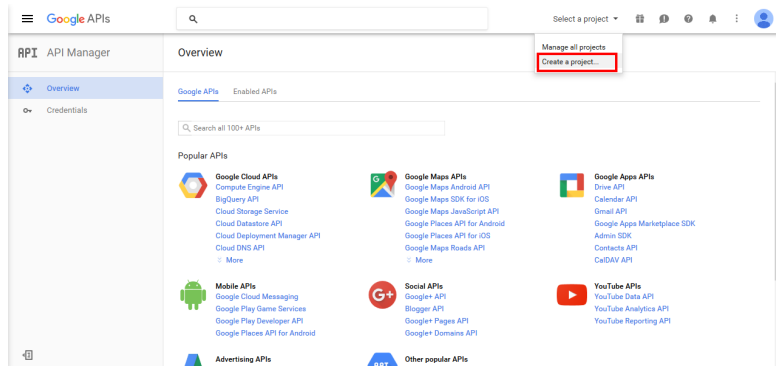

2. Click *Create a Project*.

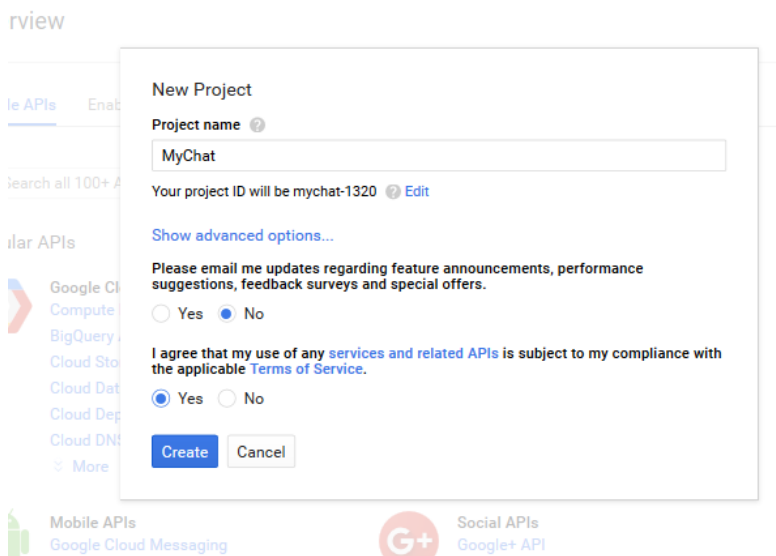

3. Input the project name, agree with the *Terms of Service* and click *Create*.

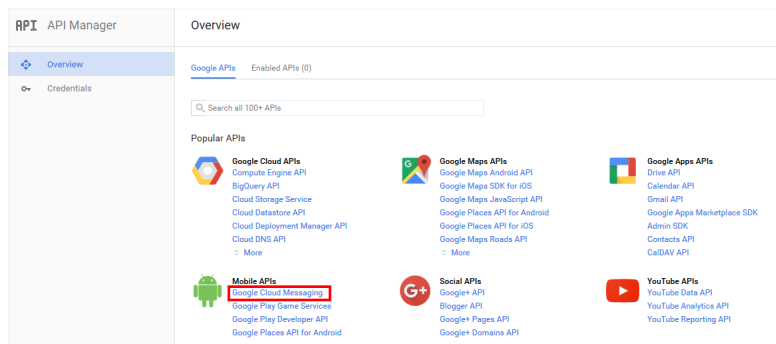

4. Click *Google Cloud Messaging* on the Overview page.

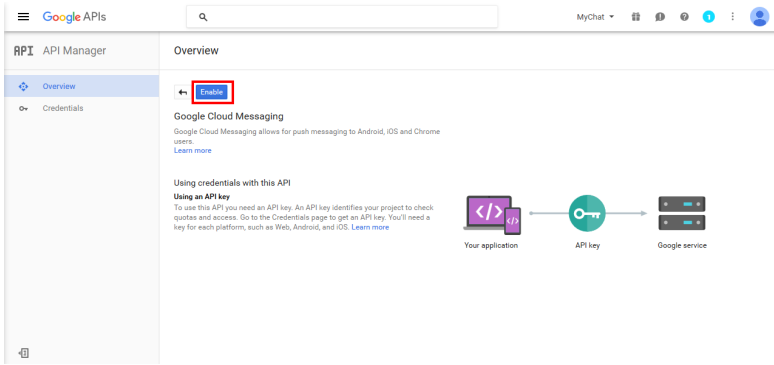

5. Click *Enable* for the Google Cloud Messaging.

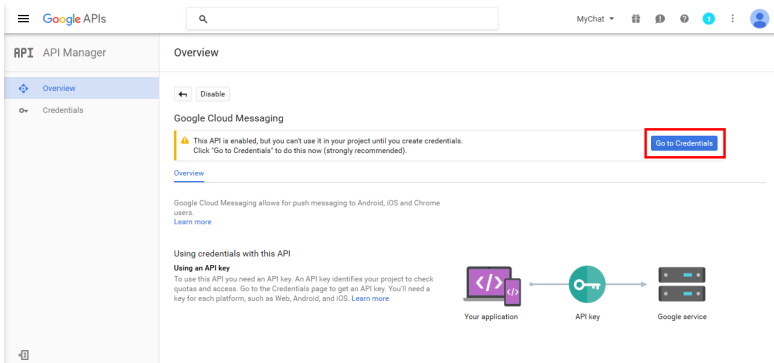

6. Click *Go to Credentials*.

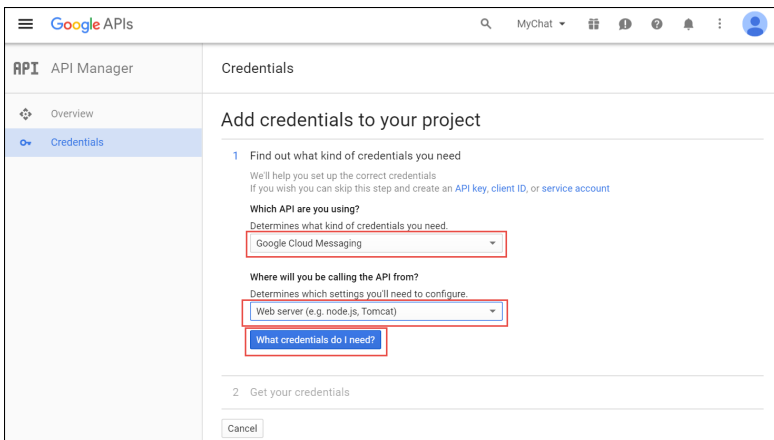

7. Select Google Cloud Messaging and Web Server from the corresponding lists and click *What credentials do I need?*

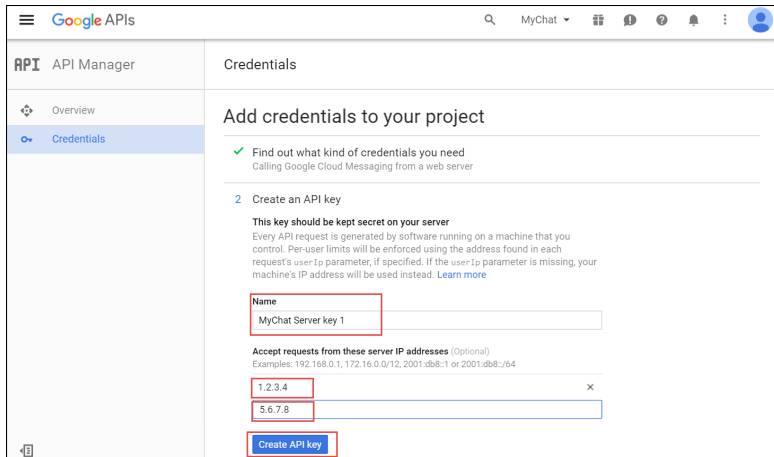

8. Adjust the API Key name and input the IP addresses of *all* your load balancers under *Accept requests from these server IP addresses*. Click *Create API key*.

**NOTE** | You may skip adding the IP addresses, otherwise list *ALL* your load balancers.

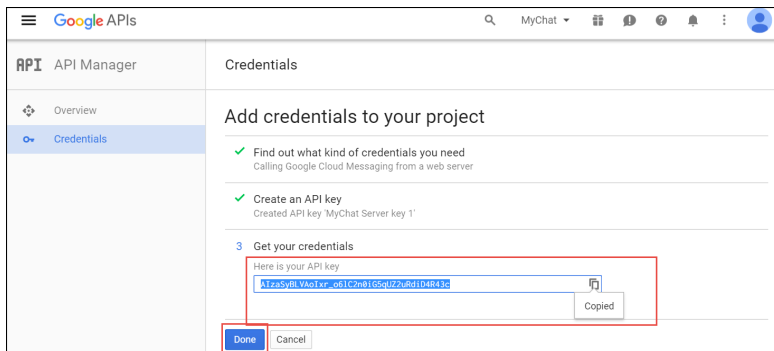

9. Copy your API key and click *Done*. Save the API key for future use.

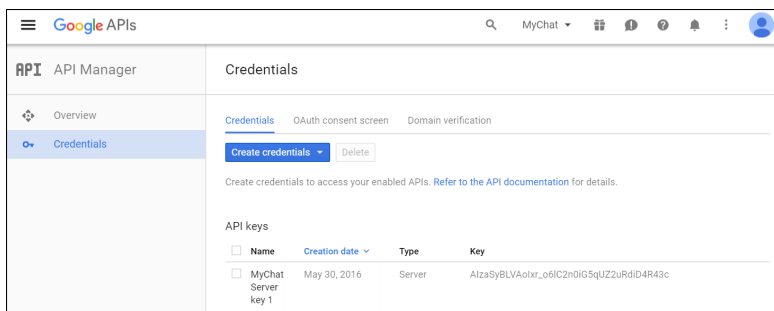

## Provide the Required Information to Developers

Please, provide Sipwise developers with the following files and information so that they can make beta builds and submit the application to the App Store:

- Access to your Apple developer account
- The trusted SSL certificate and its private key
- The Apple SSL certificate and its private key

For the Android application, provide the following:

- Access to your Google developer account

- Google application API key

### Adjust Sipwise C5 Configuration (Usually Performed by Sipwise)

1. Upload the Apple SSL certificate (**PushChatCert.pem**) and the private key (**PushChatKey.pem**) to `/etc/ngcp-config/shared-files/ssl/`
2. Upload the trusted SSL certificate (**CAsigned.crt**) and the private key (**CAsigned.key**) to `/etc/ngcp-config/shared-files/ssl/`
3. Specify the corresponding paths and names in the pushd section of the config.yml file:

```
apns: section (For iOS mobile application)
  certificate: \'/etc/ngcp-config/shared-files/ssl/PushChatCert.pem'
  enable: yes
  key: \'/etc/ngcp-config/shared-files/ssl/PushChatKey.pem'
enable: yes
android: section (for Android mobile application)
  enable: yes
  key: \'google_server_api_key_here'
ssl: yes
sslcertfile: /etc/ngcp-config/shared-files/ssl/CAsigned.crt
sslcertkeyfile: /etc/ngcp-config/shared-files/ssl/CAsigned.key
```

You can find an example of `/etc/ngcp-config/config.yml` configuration in the [config.yml overview section](#).

4. Apply your changes:

```
ngcpcfg apply 'enabled the backup feature.'
ngcpcfg push all
```

### Recheck Your DNS Zone Configuration

Check that your **NS** and **A** DNS records are correctly configured.

Let us consider the following example: \* the load-balancers have the lb01a.example.com and the lb01b.example.com names \* the shared name is lb01.example.com and the shared IP address is 203.0.113.44 \* the service name is voipservice.example.com

The following DNS records must be present:

Server Name	Record type	IP Address
lb01a.example.com	A	203.0.113.42
lb01b.example.com	A	203.0.113.43
lb01.example.com	A	203.0.113.44

voipservice.example.com	A	203.0.113.44
-------------------------	---	--------------

### Add SRV Records to DNS

Add at least one record for the **sips** service.

A regular SRV record has the following form:

```
_service._proto.name. TTL class SRV priority weight port target
```

- service: the symbolic name of the service (sips).
- proto: the transport protocol of the desired service (TCP).
- name: the domain name (ending in a dot).
- TTL: standard DNS time to live field.
- class: the standard DNS class field (this is always IN).
- priority: the priority of the target host (lower value means more preferred).
- weight: a relative weight for records with the same priority (the higher the value, the more requests will be sent).
- port: the TCP or UDP port of the service.
- target: the canonical hostname of the machine providing the service (ending in a dot).

Here are examples of the SRV records:

```
_sips._tcp.voipservice.example.com. 18000 IN SRV 10 100 5061  
voipservice.example.com.
```

You can always check whether the required SRV records are configured by executing the following commands:

```
dig SRV _sips._tcp.voipservice.example.net
```

### Check NTP Configuration

We strongly suggest that the clocks of all the nodes within the platform are synchronized. To ensure this, check that the NTP service is correctly configured on all your Sipwise C5 servers and works reliably. Execute the following command to get the time synchronization status:

```
ntpq -p
```

If the current node synchronizes with an NTP server, this server will be marked by the star (\*) symbol.

## Enable Apple/Google Mobile Push

It can be enabled for a domain or separate subscribers in the web administration panel or using API.

To enable the service:

1. Go to *Domain Preferences* or *Subscriber Preferences* of the domain/subscriber you want to enable Apple/Google Mobile Push for.
2. Go to the *Internals* group and enable the **mobile\_push\_enable** parameter selecting one of the following options:

Never send push: the mobile push feature is disabled.

Always send push: the mobile push will be triggered every time the subscriber receives a call in parallel with the already registered devices, if there are any.

Send push only if no device registered: the mobile push will be triggered only if the subscriber doesn't have any registered device. In case there is one or more devices registered only those will receive the incoming call.

Always send push, skip registered devices: the mobile push will be triggered immediately disregarding the already registered devices. That means, already registered devices do not receive the incoming call.

Registered devices, then send push: the Sipwise C5 will call the already registered devices as first. In case of failure (devices reject the call) it will then trigger the mobile push.

Send push, then registered devices: the Sipwise C5 will trigger the mobile push as first. In case of failure (push service return an error or the mobile devices reject the call) it will then send the call to the already registered devices.

[Domain Preferences] [Mobile Push Preferences] [Mobile Push Options]

## Perform Tests

Perform tests when the application is available:

1. Download and install the application.
2. Open the application and input your registration username in the username@domain.name format and password.
3. Review the quality of application branding.
4. Make test calls.
5. Test the presence functionality.
6. Test the chat and group chat.
7. Test messaging.
8. Test the sharing functionality (e.g. pictures, video and voice messages and maps).
9. Check the application phone book integration with the phone's one

Make sure that the subscribers can start using your services in the easiest possible way.

## 8.3. Lawful Interception

### 8.3.1. Introduction

The Sipwise C5, as a communications platform carrying voice, fax and messaging data has to provide means for lawful interception of the content of communication by third party entities. Those Law Enforcement Agencies (LEAs) have to be able to connect to Sipwise C5 platform in a standardized way—ETSI, 3GPP and other organisations define the interface (and data exchange) between telecommunication operators and LEAs.

High level overview of lawful interception is shown in the following figure:

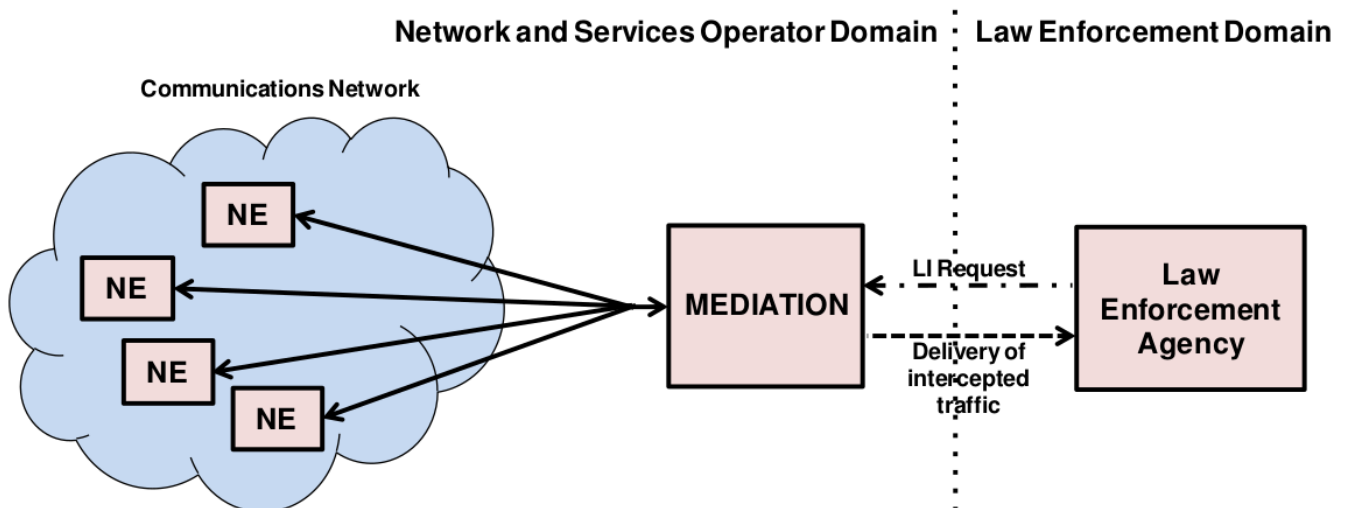

Figure 202. LI: High Level Overview

**Main interfaces** of lawful interception according to ETSI standard:

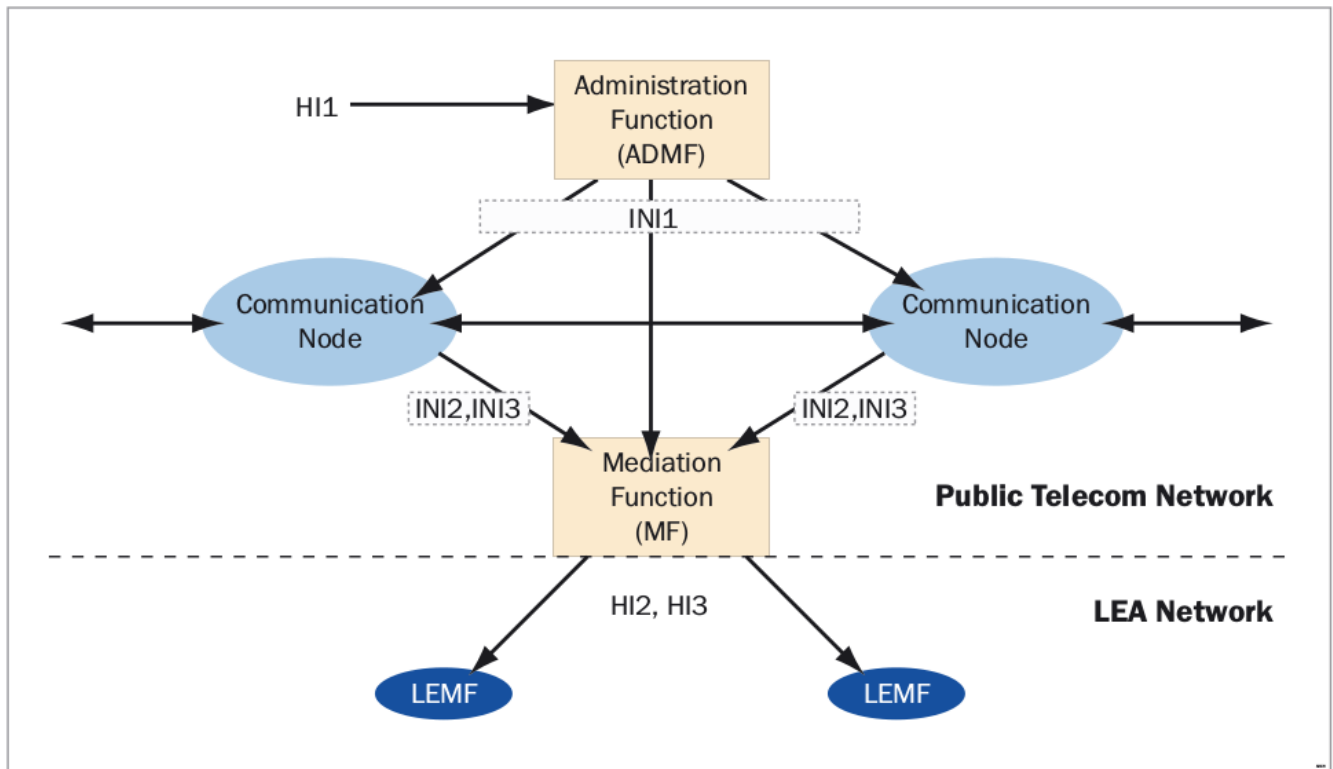

Figure 203. LI: ETSI Interfaces

## Terms and Abbreviations

### Content of Communication (CC)

Information exchanged between two or more users of a telecommunications service, excluding Intercept Related Information.

#### NOTE

This includes information which may, as part of some telecommunications service, be stored by one user for subsequent retrieval by another.

### CC Internal Interception Function (CC-IIF)

The CC-IIF shall cause the CC, specified by the CCTF, via the CCCI to be duplicated and passed to the MF.

### Content of Communication Control Interface (CCCI)

Carries controls information from the CCTF to the CC-IIF.

### CC Trigger Function (CCTF)

The purpose of the CCTF is to determine the location of the CC-IIF device associated to the target CC traffic, and to control the CC-IIF via the CCCI interface.

### Content of Communication Trigger Interface (CCTI)

Carries trigger information from the IRI-IIF to the CCTF.

### Handover Interface (HI)

Physical and logical interface across which the interception measures are requested from an operator, and the results of interception are delivered from an operator to an LEMF.

**Intercept Related Information (IRI)**

Collection of information or data associated with telecommunication services involving the target identity, specifically call or service associated information or data (e.g. call identifier, unsuccessful call attempts) and location information.

**Intercept Related Information Internal Interception Function (IRI-IIF)**

The purpose of the IRI-IIF is to generate IRI information associated with sessions, calls, connections and any other information involving interception targets identified by Law Enforcement Agency (LEA) sessions.

**Internal Network Interface (INI)**

Network's internal interface between the Internal Intercepting Function and a mediation function.

**Law Enforcement Agency (LEA)**

Organization authorized, by a lawful authorization based on a national law, to request interception measures and to receive the results of telecommunications interceptions.

**Law Enforcement Monitoring Facility (LEMF)**

Law enforcement facility designated as the transmission destination for the results of interception relating to a particular interception subject.

**Lawful Interception Administration Function (AF)**

The AF ensures that an intercept request from a LEA for IRI or CC or both is provisioned for collection from the network, and subsequent delivery to the LEMF.

**Lawful Interception Mediation Function (MF)**

Mechanism which passes information between an access provider or network operator or service provider and a handover interface.

1. Firstly it receives information related to active intercepts from the IRI-IIF(s) and CC-IIF(s) within the service provider network.
2. Secondly correlates and formats that IRI and CC information in real time for delivery to the LEMF over the HI2 and HI3 handover Interfaces.

**X1, X2 and X3 Interfaces**

The 3GPP standard for Lawful Interception defines the handover interfaces with different names compared to the ETSI standard. The  $X_n$  interface corresponds to the  $INIn$  interface and is functionally identical to the  $INIn$  interface.

**8.3.2. Architecture and Configuration of LI Service**

The Sipwise C5 platform implements the functions defined by LI requirements in a way that it relies on a third party provider for the Lawful Interception Mediation Function (MF).

Regarding other LI functions that are defined by ETSI / 3GPP standards there are 2 possible implementations:

1. The Sipwise C5 behaves as the Administration Function (AF) but the actual call data capturing is carried out by other SIP endpoints. In this case the Sipwise C5 forwards the calls to be intercepted to its **SIP peers dedicated for LI service**. Within the scope of SIP peer based solution there are still 2 modes of operation:

*Call loopback to NGCP:* the LI peer receives the call, extracts IRI and CC data and then routes the call back to NGCP. The Sipwise C5 handles the looped back call as if that was initiated from the Sipwise C5 and sets up the second call leg to the destination.

*Call forwarded by peer directly to destination:* in this case the Sipwise C5 will handle the call to LI peer as an ordinary second call leg to the destination.

2. Sipwise **Sipwise C5 itself provides** the required LI functions: AF and call data capturing; IRI and CC of intercepted calls are forwarded to the third party MF from NGCP. Sipwise C5 can be configured in two modes:

*Non-Distributed:* The LI roles are hosted on the PROXY nodes. The REST API endpoint to LEA will be the usual MGMT nodes.

*Distributed:* The LI roles are hosted on geographically distributed LB+RTP nodes, for example one pair of LB+RTP nodes per country, each of which has different law enforcement authorities. The LB+RTP nodes will provide an *ngcp-panel* instance, which due to privacy laws is specially configured to store intercepts locally (the node will operate on its own set of data), and the external party (law enforcement, LI integration, etc.) interacts with the pertinent LB+RTP nodes via the REST API (or SOAP for older installations).

This handbook will discuss the second setup in detail in the following sections.

The below figure illustrates the logical connection of LI functions on the Sipwise C5.

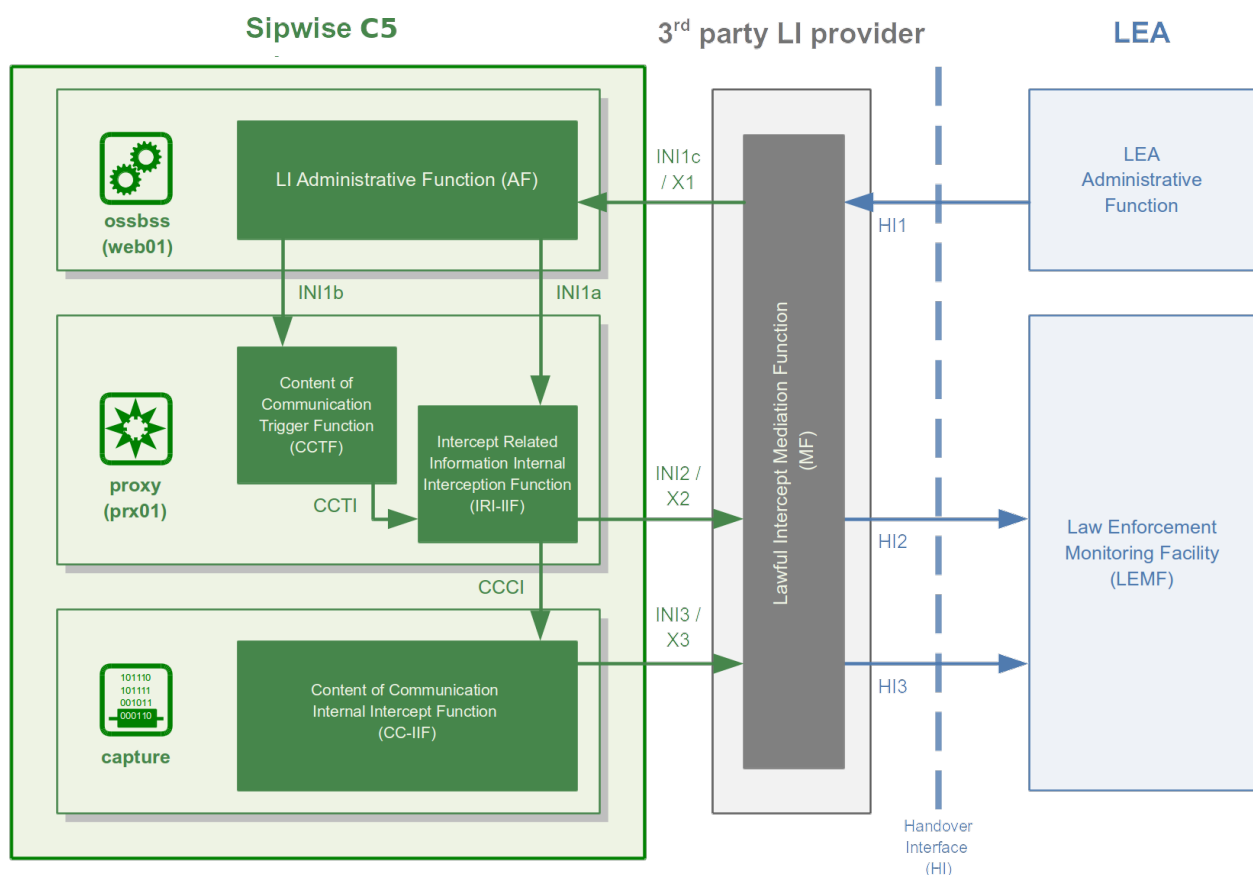

Figure 204. LI with 3rd Party Provider

## Architecture Based on NGCP Voisniff Module

The implementation of LI services with captagent is no longer available and configurable on the Sipwise C5, Sipwise requires deploying a revised solution with its ngcp-voisniff software module. This newer implementation also relies on a 3rd party LI provider representing the LI Mediation Function (MF), where Sipwise currently cooperates with Group2000, Pine and Utimaco.

**Sipwise C5 components** providing LI functions:

- **ngcp-panel:** this module is responsible for managing REST API for the whole NGCP in general  
*runs on:* the active node with web role (sp on PRO; web01 on CARRIER) on a Sipwise C5 platform  
*LI functions:* AF; INI1 / X1 interface towards the MF
- **kamailio-proxy:** this module serves as a generic call control function on the NGCP  
*runs on:* the active node typically with proxy role (sp on PRO; prx01 on CARRIER) on a Sipwise C5 platform  
*LI functions:* CCTF and IRI-IIF; INI2 / X2 interface towards the MF
- **ngcp-voisniff:** this module is a generic element for capturing SIP and RTP traffic on the NGCP  
*runs on:* the active node typically with lb role (sp on PRO; lb01 on CARRIER) on a Sipwise C5 platform  
*LI functions:* CC-IIF; INI3 / X3 interface towards the MF

### NOTE

The ngcp-voisniff module is installed by default but not activated on the Sipwise C5. It provides the possibility to get call statistics through the Admin web interface, and is not readily configured for LI services. Please contact Sipwise if you need to activate LI services on the platform.

## Authentication and Confidentiality

It is required that the communication between the telecommunication operator's network element (that is: Sipwise C5) and the MF be authenticated and confidential, since the intercepted session related data and content of communication must not be disclosed to any 3rd party. For this purpose NGCP's LI service applies authentication and LI session data encryption based on public key cryptography mechanism (TLS).

Both the Sipwise C5 and the MF must authenticate themselves by certificates, for this reason the Sipwise C5 operator must ensure that valid certificates are deployed on the system. You must contact the 3rd party LI provider, so that they can provide the necessary client certificates that the Sipwise C5 will use to setup secured connection to the MF on X2 and X3 interfaces.

Similarly, the MF provider must contact the Sipwise C5 operator to offer him valid client certificates that the MF element will use to establish secured connection to the Sipwise C5 on X1 interface.

## Configuration of LI Service

To enable LI services on the Sipwise C5 the platform administrator has to enable lawful interception through the main configuration file (config.yml).

For a distributed setup, the `cluster_sets.type` variable has to be set to 'distributed' (see [cluster\\_sets.type](#) for more information), and the `lb` nodes need to be assigned the `li` role. For a non-distributed setup, the `proxy` nodes need to be assigned the `li` role.

From the user and program point of view, the *li* role will only be visible in a node if the *intercept.enable* setting is set to 'yes'. When the cluster is set up in a distributed mode (that is *cluster\_sets.type* is set to 'distributed'), the nodes will also have the *li\_dist* virtual role visible (which is synthesized at run-time and cannot be specified in the node configuration), so that these can check for a single condition instead of multiple.

Here below is a sample configuration, which shows parameters of intercept and voisniff sections.

On a CARRIER it would look like:

```
intercept:
  enable: yes
  local: no
  peer:
    acc: no
    inbound_prefix: LI_
    outbound_prefix: intercept_
  type: voisniff

voisniff:
  admin_panel: no
  daemon:
    custom_bpf: ''
    enable: yes
    filter:
      exclude:
        - active: '0'
          case_insensitive: '1'
          pattern: '\ncseq: *\d+ +(register|notify|options)'
      include: []
    sip_ports:
      - 5060
      - 5062
  interfaces:
    extra: []
    types:
      - sip_int
      - sip_ext
      - rtp_ext
  li_x1x2x3:
    call_id:
      del_patterns:
        - _pbx\-1(?:_[0-9]{1,10})?$
        - _b2b\-1(?:_[0-9]{1,10})?$
        - _xfer\-1(?:_[0-9]{1,10})?$
    captagent:
      cin_max: '3000'
      cin_min: '0'
      x2:
        threads: 20
      client_certificate: /etc/ngcp-config/shared-
files/ssl/li/x23_client/x23_client_cert.pem
```

```

enable: yes
fix_checksums: no
fragmented: no
interface:
  excludes: []
local_name: sipwise
private_key: /etc/ngcp-config/shared-
files/ssl/li/x23_client/x23_client_cert_priv_key.pem
split_intercept: no
x1:
  port: '18090'
x23:
  protocol: sipwise
mysql_dump:
  enable: no
  max_query_len: 67108864
  num_threads: '4'
rtp_filter: yes
threads_per_interface: '10'
partitions:
  increment: '700000'
  keep: '10'

```

On a PRO it would look like:

```

intercept:
  enable: no
  local: no
  peer:
    acc: no
    inbound_prefix: LI_
    outbound_prefix: intercept_
  type: none

voisniff:
  admin_panel: yes
  daemon:
    custom_bpf: ''
    enable: yes
    filter:
      exclude:
        - active: '0'
          case_insensitive: '1'
          pattern: '\ncseq: *\d+ +(register|notify|options)'
      include: []
    sip_ports:
      - 5060
      - 5062
  interfaces:
    extra: []
    types:

```

```

- sip_int
- sip_ext
- rtp_ext
li_x1x2x3:
  call_id:
    del_patterns:
      - _pbx\-1(?:_[0-9]{1,10})?$
      - _b2b\-1(?:_[0-9]{1,10})?$
      - _xfer\-1(?:_[0-9]{1,10})?$
    captagent:
      cin_max: '3000'
      cin_min: '0'
      x2:
        threads: 20
      client_certificate: ''
      enable: no
      fix_checksums: no
      fragmented: no
      interface:
        excludes: []
      local_name: sipwise
      split_intercept: no
      x1:
        port: '18090'
      x23:
        protocol: sipwise
    mysql_dump:
      enable: yes
      max_query_len: 67108864
      num_threads: '4'
      rtp_filter: yes
      threads_per_interface: '2'
    partitions:
      increment: '700000'
      keep: '10'

```

### Configuration Parameters

#### intercept.enable

Set it to **yes** if you want to activate LI service. Default: **no**

#### intercept.local

On CARRIER systems, if set to **yes**, intercept data will be stored on the local system instead of the central database node.

#### intercept.peer.acc

Calls to be intercepted may be forwarded to LI peers. The LI peer may forward the call to the original destination, without looping the call back to the Sipwise C5. Set this parameter to **yes** if you want to enable billing for such calls. Default: **no**

**intercept.peer.inbound\_prefix**

Calls to be intercepted may be forwarded to LI peers. This parameter specifies the prefix that is prepended to SIP usernames when the call is looped back to the Sipwise C5, in order to avoid sending the call again to any LI peer. Used by the Sipwise C5 internally. Default: **LI\_**

**intercept.peer.outbound\_prefix**

Calls to be intercepted may be forwarded to LI peers. This parameter specifies the prefix that is prepended to SIP usernames when the call is routed to an LI peer. It will be stripped off by rewrite rules of the peer, before sending the call effectively to the peer. Used by the Sipwise C5 internally. Default: **intercept\_**

**intercept.type**

The LI service provider module; allowed values are:

- **none**: LI service is not activated
- **peer**: LI service is activated and call data capturing is performed by SIP peers
- **voisniff**: LI service is activated and call data capturing is performed by the voisniff module

Default: **none**

**voisniff.admin\_panel****voisniff.daemon.mysql\_dump.\*****voisniff.partitions.\***

These parameters are not used in LI configuration, but only for call statistics which can be retrieved through the Admin web interface.

**voisniff.daemon.custom\_bpf**

Allows the operator to set a custom packet filter to be used when capturing packets on the network interfaces, overriding the default packet filter generated by the system based on other configuration settings (port ranges, etc). It is not normally necessary to set this. Default: empty

**voisniff.daemon.filter.exclude**

Additional filter to determine packets that need to be excluded from capturing. This configuration parameter is a list of items, each of them has 3 components:

- **active**: Determines whether the filter is active or not. Allowed values are: **0** (false/inactive; this is the default) or **1** (true/active).
- **case\_insensitive**: Determines whether the **pattern** is case-insensitive (**1**; this is the default) or not (**0**).
- **pattern**: A regular expression providing the matching pattern for packets that have to be filtered.

**voisniff.daemon.filter.include**

Additional filter to determine packets that need to be included in capturing. The parameter has the same syntax as voisniff.daemon.filter.exclude.

**voisniff.daemon.filter.sip\_ports**

A list of ports that should be considered to carry SIP traffic. Intercepted packets that do not involve one of these ports will not be attempted to be parsed as SIP packets. This filter can be disabled by having this list empty. Default: **5060** and **5062**

### **voisniff.daemon.interfaces.extra**

This is a list of additional network interfaces (typically VLAN IDs) where `ngcp-voisniff` should listen for and capture packets. These interfaces are in addition to the list of interfaces generated by the system based on the interface types (see below).

**TIP**

VLAN interfaces have to be listed when they are used for intercepted calls. On the other hand virtual interfaces for additional IP addresses (e.g. `eth0:1`) do not have to be listed separately, because the base interface (e.g. `eth0`) will be used to capture packets.

### **voisniff.daemon.interfaces.types**

A list of network interface types that should be activated for interception. All interfaces that match the given types will be activated. Default: `sip_int`, `sip_ext`, and `rtp_ext`

### **voisniff.daemon.li\_x1x2x3.call\_id.del\_patterns**

List of NGCP-internal Call-ID suffix patterns that should be ignored when determining the original SIP Call-ID of an intercepted call.

**CAUTION**

Please refrain from modifying these patterns unless explicitly directed to do so by a Sipwise engineer. Changing the patterns may result in falsely recognised Call-IDs and eventually missed SIP messages during an intercepted call.

### **voisniff.daemon.li\_x1x2x3.captagent.cin\_min**

### **voisniff.daemon.li\_x1x2x3.captagent.cin\_max**

When using the `captagent-compatible` protocol, this specifies the range of intercept ID numbers (CIN) to be generated. Default: `0` through `3000`

### **voisniff.daemon.li\_x1x2x3.captagent.x2.threads**

When using the `captagent-compatible` protocol, this specifies the number of threads to be used for sending outgoing X2 (SIP) captures. Interception may stall if this number is set too low. Default: `20`

### **voisniff.daemon.li\_x1x2x3.client\_certificate**

The client certificate that Sipwise C5 uses to connect over TLS to a 3rd party LI provider. Relevant only when using the `sipwise` outbound protocol.

### **voisniff.daemon.li\_x1x2x3.enable**

Set it to `yes` to enable LI services via X1, X2 and X3 interfaces. Default: `no`

### **voisniff.daemon.li\_x1x2x3.fix\_checksums**

When enabled (= `yes`), Sipwise C5 will calculate UDP header checksum for packets sent out on X2 and X3 interfaces. This is necessary when the checksum calculation is normally left to the network interface hardware and therefore the UDP header checksum is inherently incorrect on application level. Also the UDP checksum must be calculated by `ngcp-voisniff` on re-assembled packets, so enable this option if there are fragmented packets in intercepted call traffic. Default: disabled (= `no`)

### **voisniff.daemon.li\_x1x2x3.fragmented**

When disabled (= `no`), `ngcp-voisniff` defragments all packets and sends out only reassembled packets via X2 and X3 interfaces. If the option is enabled (= `yes`), `ngcp-voisniff` will instead send out the original fragments via X2 and X3. Default: `no`

### **voisniff.daemon.li\_x1x2x3.instant\_intercept**

When disabled (= `no`), creating a new interception object does not affect already running calls. In

other words, if a call that is already running matches the parameters by a newly created interception object, that call will not start to be intercepted, only new calls established afterwards will. Enabling this option changes this behaviour so that already running calls will also start to be intercepted at the moment when a new interception object is created. Doing so creates additional processing overhead within *ngcp-voisniff*. Default: **no**

#### **voisniff.daemon.li\_x1x2x3.interface.excludes**

This is a list of interfaces that must be excluded from the interception procedures. The list contains regular expressions that describe the to-be-excluded interfaces, for example: - **^lo\$** to exclude the loopback interface. Default: empty list

#### **voisniff.daemon.li\_x1x2x3.local\_name**

This parameter maps to the header.source field of the X2 protocol. It is an arbitrary string and can be used to identify the sending Sipwise C5 system. Default: **sipwise**

**NOTE** | This is currently not used.

#### **voisniff.daemon.li\_x1x2x3.private\_key**

The private key that Sipwise C5 uses to connect over TLS to a 3rd party LI provider. Only necessary if the client certificate file does not include the private key.

#### **voisniff.daemon.li\_x1x2x3.split\_intercept**

When enabled (= **yes**), *ngcp-voisniff* uses the Split-LI algorithm to detect which calls have to be intercepted. This algorithm should be enabled only on CARRIER systems with a central core and local satellites architecture and *ngcp-voisniff* running on LB nodes. Default: **no**

#### **voisniff.daemon.li\_x1x2x3.x1.port**

The port number on which *ngcp-voisniff* listens for incoming X1 messages. Default: **18090**

**CAUTION** | Please refrain from modifying these patterns unless explicitly directed to do so by a Sipwise engineer.

#### **voisniff.daemon.li\_x1x2x3.x23.protocol**

Specified the outbound protocol to speak when delivering X2 (SIP) or X3 (RTP) data. This can be either the **sipwise** protocol using TLS connections, or the **captagent** compatible protocol using HTTP and UDP. Default: **sipwise**

#### **voisniff.daemon.mysql\_dump.enable**

Master switch for call statistics collection. Default: **yes**

#### **voisniff.daemon.mysql\_dump.max\_query\_len**

Determines how much data should be gathered into a single statement for insertion into the database. This should not normally be changed. Default: **67108864**

#### **voisniff.daemon.mysql\_dump.num\_threads**

The number of threads dedicated to inserting data into the database. Default: **4**

#### **voisniff.daemon.rtp\_filter**

Determined whether to intercept RTP packets or not. Enabling the filter (set to **yes**) suppresses interception of RTP packets. Disabling it (**no**) enabled interception of RTP packets. Default: **yes**

**voisniff.daemon.enable**

Determines whether voisniff service must be started on the platform. Set it to **yes** if you would like to activate voisniff. Default: **no** (on CARRIER), **yes** (on PRO)

**voisniff.daemon.threads\_per\_interface**

This is a performance tuning option and controls how many threads per enabled sniffing interface should be launched. Example: if it is set to 10, and 3 interfaces are enabled for sniffing, a total of 30 threads will be launched. Default: **2**

**CAUTION**

It is recommended not to increase too much this number unless there is a performance problem with voisniff service. Please keep in mind that a high number of threads might also decrease the overall system performance of the Sipwise C5.

**8.3.3. X1, X2 and X3 Interface Specification**

Short description of  $X_n$  interfaces:

- The **X1** interface is used by an LI provider to create, modify, delete and list interceptions on the Sipwise C5. It is designed as RESTful HTTP interface using JSON (with JSON-HAL in responses from the NGCP) as content type to provision interceptions.
- The **X2** interface is a TLV based interface with JSON payload with a simple request/response mechanism over a secure TLS connection, used to pass intercepted signaling data towards an LI provider.
- The **X3** interface is also a TLV based interface with a binary payload encapsulating the intercepted RTP data.

**X1 Interface**

The resource used to work with interceptions is always `https://ngcp-ip:1443/api/interceptions/`

**Authentication**

Authentication and authorization on the Sipwise C5 API is performed via HTTP Basic Auth or SSL Client certificates.

- **HTTP Basic Auth:** With `cURL` use `--user username:password` option to specify your access credentials.

```
curl -i -X GET --user myuser:mypassword
https://example.org:1443/api/interceptions/
```

Additionally use the `--insecure` option if you are testing against a self-signed server certificate.

- **SSL Client Authentication:** You can generate and download client certificates for administrators and resellers via the Sipwise C5 web interface in the Administrators view.

For the actual client authentication, you will need two files which you can download from the panel after creating the client certificates:

1. The client certificate generated via the Sipwise C5 web interface. This is usually labelled NGCP-API-client-certificate-xxxxx.pem.
2. The CA certificate used to sign the server certificate, in case it as been self-signed or the CA is not recognized by the client host environment.

With `cURL` use `--cert /path/to/NGCPAPIclientcertificatexxxx.pem` to specify the client certificate, and `--cacert /path/to/cacert.pem` to specify the CA certificate in case of a self-signed server certificate.

```
curl -i -X GET --cert /path/to/NGCPAPIclientcertificatexxxx.pem \
--cacert /path/to/cacert.pem
https://example.org:1443/api/interceptions/
```

Additionally use the `--insecure` option if you are testing against a self-signed server certificate.

### API Description

#### Collection Actions

Allowed methods for the collection as in METHOD /api/interceptions/

- OPTIONS
- POST
- GET
- HEAD

#### Item Actions

Allowed methods for a collection item as in METHOD /api/interceptions/id

- PATCH
- OPTIONS
- DELETE
- PUT
- GET
- HEAD

#### Properties

- `liid` (Number): The LI ID for this interception.
- `number` (String): The number to intercept.
- `x2_host` (String): The IP address of the X2 interface.
- `x2_password` (null, String): The password for authenticating on the X2 interface.
- `x2_port` (Number): The port of the X2 interface.
- `x2_user` (null, String): The username for authenticating on the X2 interface.
- `x3_host` (null, String): The IP address of the X3 interface.
- `x3_port` (null, Number): The port of the X3 interface.

- `x3_required` (null, Boolean): Whether to also intercept call content via X3 interface (**false** by default).

### Query Parameters

- `liid`: Filter for interceptions of a specific interception ID
- `number`: Filter for interceptions of a specific number (in E.164 format)
- `order_by`: Order collection by a specific attribute. Possible values are: `id`, `reseller_id`, `liid`, `number`, `cc_required`, `delivery_host`, `delivery_port`, `delivery_user`, `delivery_pass`, `modify_timestamp`, `create_timestamp`, `deleted`, `uuid`, `sip_username`, `sip_domain`, `cc_delivery_host`, `cc_delivery_port`
- `order_by_direction`: Direction which the collection should be ordered by. Possible values are: `asc` (default), `desc`

### API Examples

#### Get a specific interception

- Request:

```
curl -i --insecure --user administrator:administrator -X GET
https://localhost:1443/api/interceptions/528
```

- Response:

```
HTTP/1.1 200 OK
Server: nginx
Date: Tue, 01 Dec 2015 09:43:41 GMT
ContentType: application/hal+json;
profile="http://purl.org/sipwise/ngcpapi/";
  charset=utf8
ContentLength: 634
Connection: keepalive
Link: </api/interceptions/>; rel=collection
Link: <http://purl.org/sipwise/ngcpapi/>; rel=profile
Link: </api/interceptions/528>; rel="item self"
SetCookie:
ngcp_panel_session=35b56d921c36c1fc6edb8fcd0a86dd9af61ec62a; path=/;
  expires=Tue, 01Dec 2015 10:43:41 GMT; HttpOnly
StrictTransportSecurity: maxage=15768000
{
  "_links" : {
    "collection" : {
      "href" : "/api/interceptions/"
    },
    "curies" : {
      "href" : "http://purl.org/sipwise/ngcpapi/#rel{rel}",
      "name" : "ngcp",
      "templated" : true
    },
    "profile" : {
```

```

    "href" : "http://purl.org/sipwise/ngcpapi/"
  },
  "self" : {
    "href" : "/api/interceptions/528"
  }
},
"id" : 528,
"liid" : 918273,
"number" : "0014155550132",
"x2_host" : "192.168.42.42",
"x2_password" : null,
"x2_port" : 3002,
"x2_user" : null,
"x3_host" : "192.168.42.42",
"x3_port" : 3003,
"x3_required" : true
}

```

### Get all interceptions for a number

- Request:

```

curl -i --insecure --user administrator:administrator -X GET \
https://localhost:1443/api/interceptions/?number=0014155550132

```

- Response:

```

HTTP/1.1 200 OK
Server: nginx
Date: Tue, 01 Dec 2015 09:47:36 GMT
ContentType: application/hal+json;
profile="http://purl.org/sipwise/ngcpapi/";
  charset=utf8
ContentLength: 1283
Connection: keepalive
SetCookie:
ngcp_panel_session=238550c5737058db619b183d925b5f9a61261cfe; path=/;
  expires=Tue, 01 Dec 2015 10:47:36 GMT; HttpOnly
StrictTransportSecurity: maxage=15768000
{
  "_embedded" : {
    "ngcp:interceptions" : {
      "_links" : {
        "collection" : {
          "href" : "/api/interceptions/"
        },
        "curies" : {
          "href" : "http://purl.org/sipwise/ngcpapi/#rel{rel}",
          "name" : "ngcp",

```

```

        "templated" : true
      },
      "profile" : {
        "href" : "http://purl.org/sipwise/ngcpapi/"
      },
      "self" : {
        "href" : "/api/interceptions/520"
      }
    },
    "id" : 520,
    "liid" : 1,
    "number" : "0014155550132",
    "x2_host" : "192.168.42.42",
    "x2_password" : null,
    "x2_port" : 3002,
    "x2_user" : null,
    "x3_host" : "192.168.42.42",
    "x3_port" : 3003,
    "x3_required" : true
  }
},
"_links" : {
  "curies" : {
    "href" : "http://purl.org/sipwise/ngcpapi/#rel{rel}",
    "name" : "ngcp",
    "templated" : true
  },
  "ngcp:interceptions" : {
    "href" : "/api/interceptions/520"
  },
  "profile" : {
    "href" : "http://purl.org/sipwise/ngcpapi/"
  },
  "self" : {
    "href" : "/api/interceptions/?page=1&rows=10"
  }
},
"total_count" : 1
}

```

### Get all interceptions for all numbers

- Request:

```
curl -i --insecure --user administrator:administrator -X GET \
https://localhost:1443/api/interceptions/
```

- Response:

```

HTTP/1.1 200 OK
Server: nginx
Date: Tue, 01 Dec 2015 09:43:18 GMT
ContentType: application/hal+json;
profile="http://purl.org/sipwise/ngcpapi/";
  charset=utf8
ContentLength: 2364
Connection: keepalive
SetCookie:
ngcp_panel_session=68398eea5bdd3885ad0517e1f6d367ccc80111fa; path=/;
  expires=Tue, 01 Dec 2015 10:43:18 GMT; HttpOnly
StrictTransportSecurity: maxage=15768000
{
  "_embedded" : {
    "ngcp:interceptions" : [
      {
        "_links" : {
          "collection" : {
            "href" : "/api/interceptions/"
          },
          "curies" : {
            "href" : "http://purl.org/sipwise/ngcpapi/#rel-
{rel}",
            "name" : "ngcp",
            "templated" : true
          },
          "profile" : {
            "href" : "http://purl.org/sipwise/ngcpapi/"
          },
          "self" : {
            "href" : "/api/interceptions/520"
          }
        },
        "id" : 520,
        "liid" : 1,
        "number" : "0014155550132",
        "x2_host" : "192.168.42.42",
        "x2_password" : null,
        "x2_port" : 3002,
        "x2_user" : null,
        "x3_host" : "192.168.42.42",
        "x3_port" : 3003,
        "x3_required" : true
      },
      {
        "_links" : {
          "collection" : {
            "href" : "/api/interceptions/"
          },
          "curies" : {
            "href" : "http://purl.org/sipwise/ngcpapi/#rel-

```

```

{rel}",
    "name" : "ngcp",
    "templated" : true
  },
  "profile" : {
    "href" : "http://purl.org/sipwise/ngcpapi/"
  },
  "self" : {
    "href" : "/api/interceptions/528"
  }
},
"id" : 528,
"liid" : 918273,
"number" : "0014155550132",
"x2_host" : "192.168.42.42",
"x2_password" : null,
"x2_port" : 3002,          "x2_user" : null,
"x3_host" : "192.168.42.42",
"x3_port" : 3003,
"x3_required" : true
  }
]
},
"_links" : {
  "curies" : {
    "href" : "http://purl.org/sipwise/ngcpapi/#rel{rel}",
    "name" : "ngcp",
    "templated" : true
  },
  "ngcp:interceptions" : [
    {
      "href" : "/api/interceptions/520"
    },
    {
      "href" : "/api/interceptions/528"
    }
  ],
  "profile" : {
    "href" : "http://purl.org/sipwise/ngcpapi/"
  },
  "self" : {
    "href" : "/api/interceptions/?page=1&rows=10"
  }
},
"total_count" : 2
}

```

### Get interception for specific LIID

- Request:

```
curl -i --insecure --user administrator:administrator -X GET \
https://localhost:1443/api/interceptions/?liid=9876
```

- Response:

```
HTTP/1.1 200 OK
Server: nginx
Date: Tue, 01 Dec 2015 09:50:41 GMT
ContentType: application/hal+json;
profile="http://purl.org/sipwise/ngcpapi/";
  charset=utf8
ContentLength: 1283
Connection: keepalive
SetCookie:
ngcp_panel_session=23960dde6bb90f0c5c84575890194c53cce120ce; path=/;
  expires=Tue, 01 Dec 2015 10:50:40 GMT; HttpOnly
StrictTransportSecurity: maxage=15768000
{
  "_embedded" : {
    "ngcp:interceptions" : {
      "_links" : {
        "collection" : {
          "href" : "/api/interceptions/"
        },
        "curies" : {
          "href" : "http://purl.org/sipwise/ngcpapi/#rel{rel}",
          "name" : "ngcp",
          "templated" : true
        },
        "profile" : {
          "href" : "http://purl.org/sipwise/ngcpapi/"
        },
        "self" : {
          "href" : "/api/interceptions/520"
        }
      },
      "id" : 520,
      "liid" : 1,
      "number" : "0014155550132",
      "x2_host" : "192.168.42.42",
      "x2_password" : null,
      "x2_port" : 3002,
      "x2_user" : null,
      "x3_host" : "192.168.42.42",
      "x3_port" : 3003,
      "x3_required" : true
    }
  },
  "_links" : {
    "curies" : {
```

```

    "href" : "http://purl.org/sipwise/ngcpapi/#rel{rel}",
    "name" : "ngcp",
    "templated" : true
  },
  "ngcp:interceptions" : {
    "href" : "/api/interceptions/520"
  },
  "profile" : {
    "href" : "http://purl.org/sipwise/ngcpapi/"
  },
  "self" : {
    "href" : "/api/interceptions/?page=1&rows=10"
  }
},
"total_count" : 1
}

```

### Create interception for a specific number

- Request:

```

curl -i --insecure --user administrator:administrator -X POST \
-H "ContentType: application/json" --data \
'{"liid":123, "number":"31032222203", "x2_host":"127.0.0.1",
"x2_port":12345,
"x3_required":true, "x3_host":"127.0.0.2", "x3_port":23456}' \
https://localhost:1443/api/interceptions/

```

- Response:

```

HTTP/1.1 201 Created
TransferEncoding: chunked
Connection: close
Location: /api/interceptions/528
SetCookie:
ngcp_panel_session=e7817079d121fae4d86448b10e1fa21d0201c526; path=/;
  expires=Tue, 01 Dec 2015 10:43:18 GMT; HttpOnly
StrictTransportSecurity: maxage=15768000

```

The path to the newly created interception is found in the *Location* header of the response.

### Update specific interception

- Request:

```

curl -i --insecure --user administrator:administrator -X PUT \
-H "ContentType: application/json" -H 'Prefer: return=representation'
--data \

```

```
'{"liid":918273, "number":"0014155550132", "x2_host":"192.168.42.42",
"x2_port":5000,
"x3_required":false}' \
https://localhost:1443/api/interceptions/123
```

- Response:

```
HTTP/1.1 200 OK
ContentType: application/hal+json;
profile="http://purl.org/sipwise/ngcpapi/";
  charset=utf8
ContentLength: 621
Link: </api/interceptions/>; rel=collection
Link: <http://purl.org/sipwise/ngcpapi/>; rel=profile
Link: </api/interceptions/530>; rel=self
PreferenceApplied: return=representation
SetCookie:
ngcp_panel_session=0b56e4a197b0e9f6e22a998e85473a0184770740; path=/;
  expires=Tue, 01 Dec 2015 10:56:17 GMT; HttpOnly
{
  "_links" : {
    "collection" : {
      "href" : "/api/interceptions/"
    },
    "curies" : {
      "href" : "http://purl.org/sipwise/ngcpapi/#rel{rel}",
      "name" : "ngcp",
      "templated" : true
    },
    "profile" : {
      "href" : "http://purl.org/sipwise/ngcpapi/"
    },
    "self" : {
      "href" : "/api/interceptions/530"
    }
  },
  "id" : 530,
  "liid" : 918273,
  "number" : "0014155550132",
  "x2_host" : "192.168.42.42",
  "x2_password" : null,
  "x2_port" : 5000,
  "x2_user" : null,
  "x3_host" : null,
  "x3_port" : null,
  "x3_required" : false
}
```

The *Prefer: return=representation* header forces the API to return the content, otherwise status 201 with no content is returned.

## Update only certain items for a specific interception

- Request:

```
curl -i --insecure --user administrator:administrator -X PATCH \
-H "ContentType: application/jsonpatch+json" -H 'Prefer:
return=representation' \
--data '[{"op":"replace", "path":"/x2_host",
"value":"192.168.42.42"}, {"op":"replace",
"path":"/x2_port", "value":4000}]' \
https://localhost:1443/api/interceptions/530
```

- Response:

```
HTTP/1.1 200 OK
Server: nginx
Date: Tue, 01 Dec 2015 10:06:06 GMT
ContentType: application/hal+json;
profile="http://purl.org/sipwise/ngcpapi/";
charset=utf8
ContentLength: 620
Connection: close
Link: </api/interceptions/>; rel=collection
Link: <http://purl.org/sipwise/ngcpapi/>; rel=profile
Link: </api/interceptions/530>; rel=self
PreferenceApplied: return=representation
SetCookie:
ngcp_panel_session=0693129d63d543a85f96d464ff9a8f807cfc4d18; path=/;
expires=Tue, 01 Dec 2015 11:06:06 GMT; HttpOnly
StrictTransportSecurity: maxage=15768000
{
  "_links" : {
    "collection" : {
      "href" : "/api/interceptions/"
    },
    "curies" : {
      "href" : "http://purl.org/sipwise/ngcpapi/#rel{rel}",
      "name" : "ngcp",
      "templated" : true
    },
    "profile" : {
      "href" : "http://purl.org/sipwise/ngcpapi/"
    },
    "self" : {
      "href" : "/api/interceptions/530"
    }
  },
  "id" : 530,
  "liid" : 918273,
  "number" : "0014155550132",
```

```

"x2_host" : "192.168.42.42",
"x2_password" : null,
"x2_port" : 4000,
"x2_user" : null,
"x3_host" : null,
"x3_port" : null,
"x3_required" : false
}

```

### Delete specific interception

- Request:

```

curl -i --insecure --user administrator:administrator -X DELETE \
https://localhost:1443/api/interceptions/123

```

- Response:

```

HTTP/1.1 204 No Content
Server: nginx
Date: Tue, 01 Dec 2015 10:08:49 GMT
Connection: keepalive
SetCookie:
ngcp_panel_session=570c66b66732629766f86b8ed9bd0d64902ae73e; path=/;
    expires=Tue, 01 Dec 2015 11:08:49 GMT; HttpOnly
XCatalyst: 5.90042
StrictTransportSecurity: maxage=15768000

```

### X2 Interface

The communication via the X2 interface consists of request-response pairs.

#### Request

The request is formatted as: X2/<bodylength>/<body>

**Body** part has the following items:

Table 37. X2 Message Body Items

Element	Type	Length	Description
/x2/header/source	String	arbitrary length	identifier of Sipwise node which captured the data
/x2/header/destination	String	arbitrary length	identifier of LI mediation system
/x2/header/type	String	arbitrary length	always "sip" (but later potentially others too)

Element	Type	Length	Description
/x2/header/version	PosInteger	arbitrary length	always "1"
/x2/header/timestamp	String	27 chars	format: YYYY-MM-DDThh:mm:ss.ffffffZ; timestamp in UTC when the X2 package is sent to mediation
/x2/body/dialogid	PosInteger	arbitrary length	globally increasing counter for each new communication dialog (e.g. call)
/x2/body/messageid	PosInteger	arbitrary length	increasing counter for each new x2 message within a dialog, starting from 0
/x2/body/timestamp	String	27 chars	format: YYYY-MM-DDThh:mm:ss.ffffffZ; timestamp in UTC when the package has been captured on the wire
/x2/body/interceptions			one or more elements containing the following information, one element per intercepted target:
/x2/body/interceptions/liid	PosInteger	arbitrary length	interception id ("liid") as set via X1 interface
/x2/body/interceptions/direction	String	arbitrary length	either "totarget" or "fromtarget" from the soft-switch perspective (if target is the called party, it is "totarget", if target is the calling party, it is "fromtarget").
/x2/body/data	Base64 encoded	arbitrary	content of full IP frame and up on the OSI layer; packets fragmented on the wire are provided in fully assembled format

**Example** of full message:

```
X2/418/
{
  "header": {
    "source": "prx01a.example.com",
    "destination": "x2destination.example.com",
    "type": "sip",
    "version": 1,
    "timestamp": "20150311T09:18:04.729803Z"
  },
  "body": {
    "dialogid": 4,
    "messageid": 0,
    "timestamp": "20150311T09:18:04.729123Z",
    "interceptions": [
      { "liid": 174, "direction": "fromtarget" },
      { "liid": 175, "direction": "totarget" }
    ],
    "data": "<base64 encoded ip,udp/tcp,sip frame>"
  }
}
```

**Response**

- Success: X2-ACK/0/
- Error: X2-ERR/<length>/<error string>

**Keep-Alive Mechanism**

A regular keep-alive mechanism with a default value of 10s is used on the connection if it is re-used across multiple messages.

- Request: X2/0/
- Response: X2-ACK/0/

**X3 Interface**

On the X3 interface TLV based packets are sent via secured (TLS) connection on a pre-established stream. X3 messages do not need to be acknowledged, except for keep-alive messages.

**X3 Message Structure**

Table 38. X3 Message Structure

Field	Length
Header	arbitrary
CCCID	4 bytes
MessageId	4 bytes
Timestamp	8 bytes
Payload	arbitrary

**Header Details**

Table 39. X3: Header Details

Field	Length	Content
type	2 bytes	always "X3"
delimiter	1 byte	always "/"
length	arbitrary	ASCII string
delimiter	1 byte	always "/"

**CCCID Details**

dialogid (32 bit in network byte order, reset to 0 after  $2^{32}-1$ )

The dialogid is referencing the /x2/body/dialogid field in order to correlate an X3 packet to an X2 call.

**MessageId Details**

messageid (32 bit in network byte order, reset to 0 after  $2^{32}-1$ )

The messageid is a counter within a dialog sequencing the X3 packets sent from the NGCP. This counter is not correlated in any way with X2, rather than starting at 0 with the first RTP packet captured within a dialog.

### Timestamp Details

- seconds (32 bit in network byte order)
- fraction (32 bit in network byte order)

The timestamp represents the Unix epoch starting from 1970-01-01.

### Payload Details

Table 40. X3: Payload Details

Field	Length
original ip header	20 bytes for v4, 40 bytes for v6
original udp header	8 bytes
original rtp header	variable, 12-72 bytes
original rtp payload	arbitrary

### Keep-Alive Mechanism

A regular keep-alive mechanism with a default value of 10s is used on the connection if it is re-used across multiple messages.

- Request: X3/0/
- Response: X3-ACK/0/

## 8.3.4. Lightweight Lawful Interception

The Sipwise C5 also provide a lightweight version for Lawful interception where each call of a user under interception are recorded and saved as .wav file locally. This lightweight version can be enabled via config.yml and requires to have rtpengine.recording.enable set to 'yes'.

```

rtpengine:
  recording:
    enable: yes
    lightweight_lawful_intercept:
      enable: yes
      recording_pattern: lwli-%{uuid}-%{callee}-%Y%m%d%H%M%S
      output_single: no

```

When lightweight\_lawful\_intercept.enable is set to 'yes' the Sipwise C5 administrator can put a user under interception by enabling the call recording for that particular user (enable subscriber's preferences 'record\_call'). Every call received and performed by that user will be recorded and the .wav file will be saved under the folder defined in rtpengine.recording.output\_dir. The file will have a pattern

name defined by `lightweight_lawful_intercept.recording_pattern` and the call recorded, in this case, will not be exposed to the end user like the standard call recording.

**WARNING**

When the `lightweight_lawful_intercept` is enabled, the standard call recording feature will not be available!

## 8.4. 3PCC functionality (TPCC), CSTA sessions and Websocket component

### 8.4.1. Abbreviations / definitions used in this chapter

- 3PCC - Third Party Call Control, which is a concept for managing calls from the separate network element (for e.g. through `ngcp-websocket` using CSTA). In a scope of this chapter, 3PCC is the `.so` module connected via the SEMS component and it implements the third party call control in the Sipwise C5.

**NOTE**

Sometimes 3PCC can be also written as TPCC.

- 1PCC - First Party Call Control, which is a usual/manual way of originating/managing calls. In other words, when Alice calls Bob manually using SIP hard- / softphone (she can put Bob on hold and then terminate the session if needed).
- CSTA - Computer Supported Telecommunication Application(s). Is a protocol for voice service invocations using XML-based messages, which works via the WebSocket protocol (that implements a role of a transport mechanism for the CSTA messages). It is implemented by the `ngcp-websocket` component, which interacts with the Kamailio-Proxy for a purpose of calls monitoring and with the SEMS for calls control (3PCC).

**NOTE**

Standard ECMA-269 - "Services for Computer Supported Telecommunications Applications (CSTA) Phase III" : <https://www.ecma-international.org/publications-and-standards/standards/ecma-269/> Standard ECMA-323 - "XML protocol for Computer Supported Telecommunications Applications (CSTA) Phase III" : <https://www.ecma-international.org/publications-and-standards/standards/ecma-323/> Standard ECMA-TR/82 - "Scenarios for Computer Supported Telecommunications Applications (CSTA) Phase III" : <https://www.ecma-international.org/publications-and-standards/technical-reports/ecma-tr-82/>

- FIFO - fifo socket (first in / first out), in other words program's in-queue / out-queue. In a scope of this chapter this is related to the SEMS, which has a dedicated FIFO implemented in the 3PCC (TPCC) module.
- SEMS - this is a `sems-b2b` component, through which the 3PCC (TPCC) module is connected to whole architecture/stack.
- `ngcp-websocket` - this is the websocket component and is used to interconnect the `sems-b2b` and the `kamailio-proxy` with the CSTA environment. The main purpose is to send/receive commands to the dedicated redis channels, which can trigger some job/action to be implemented either on `sems-b2b/kamailio-proxy` side or in the CSTA environment (for e.g. change of SIP call status).
- `protobuf` - protocol buffers is Google's language- / platform-neutral,extensible mechanism for serializing structured data – think XML, but smaller, faster, and simpler.

**NOTE**

[https://en.wikipedia.org/wiki/Protocol\\_Buffers](https://en.wikipedia.org/wiki/Protocol_Buffers)

- WebSocket protocol - is a transport mechanism used for the CSTA messages.

**NOTE** | WebSocket protocol is compatible with RFC6455: <https://tools.ietf.org/html/rfc6455>

## 8.4.2. Introduction

This chapter covers CSTA call flows of the 3PCC model and various extended telephony services based on that. It shows how the relations between different components involved into CSTA processing, make it possible to establish SIP-based sessions/dialogs. It includes different possible call scenarios, which can be done using CSTA/3PCC and how to use API in order to trigger them.

The CSTA model is implemented based on the ECMA-269 Phase III and ECMA TR/82 standards. It uses XML format with ECMA-323 XSD to carry required metadata over the WebSocket protocol.

In practice you can use your own web-based application or any other kind of application capable of sending IP-packets, to realize the following stack:

- web client (web GUI for user)
- CSTA via the WebSocket protocol
- ngcp-websocket component
- 3PCC (TPCC) module of the SEMS-b2b component

A good example of such integration is the [Rainbow](#) developed by Alcatel Lucent Enterprise, which is used as a superstructure in a combination with the Sipwise C5 to give users all capabilities of the CSTA.

## 8.4.3. CSTA and WebSocket protocol

CSTA session is being established using WebSocket protocol. Which makes it possible to control sessions via the ngcp-websocket component of the Sipwise C5. As already mentioned before, the WebSocket protocol is compatible with RFC6455.

Devices that are visible or controllable via CSTA are known as CSTA Devices.

CSTA Devices can be either physical devices (such as SIP hardphone) or logical devices (such as groups of devices, pilot numbers). CSTA Devices have attributes that allow CSTA to monitor and manipulate them.

The most important CSTA requests/event types used in the setup with the Sipwise C5:

- *MakeCall* - originate a call with a remote side
- *HoldCall* - put a remote side on hold
- *ConsultationCall* - initiate a consultation call with a third side
- *ClearConnection* - finalize a connection/terminate a session
- *MonitorStart* - start monitoring of device
- *RequestSystemStatus* - establish a connection with the CSTA system (ngcp-websocket)
- *OriginatedEvent* - indicates to the caller, that an invitation has been sent to the remote device (however not answered yet)
- *ServiceInitiatedEvent* - indicates to the caller, that an invitation has been sent to the originating

device (however not answered yet)

- *DeliveredEvent* - indicates that remote device has started to ring (180/183)
- *EstablishedEvent* - indicates that remote device has answered a call (200OK)
- *HoldEvent* - indicates that the session has been successfully put on hold
- *ConnectionClearedEvent* - indicates a call clearing/termination phase (due to whatever reason)
- *FailedEvent* - indicates that a previously requested event has not been delivered as intended (for e.g. on an invitation we've gotten 486 from a remote device)

Some of the most important attributes used in the setup with the Sipwise C5:

- *monitorCrossRefID* - this is a monitor cross reference identifier parameter, which associates the event with the established monitor
- *initiatedConnection* - this parameter specifies the connection, at which a service was initiated
- *originatedConnection* - this parameter specifies the connection, at which a call was originated
- *callID* - an identifier which is used to represent a valid call
- *deviceID* - an identifier which is used to represent a device in the domain
- *callingDevice* - this parameter in the Call Control events represents the calling device associated with the call
- *calledDevice* - this parameter specifies an originally called device. In case of prompting, this parameter specifies the device that will be called after the prompt is answered
- *initiatingDevice* - this parameter specifies the initiating device
- *answeringDevice* - this parameter specifies the device that has been connected to the call
- *deviceIdentifier* - this parameter keeps the SIP URI of callingDevice/calledDevice/initiatingDevice/alertingDevice/answeringDevice
- *localConnectionInfo* - this parameter specifies the local connection state of device associated with the 'monitorCrossRefID'
- *cause* - this parameter specifies the reason for the event (for e.g.: 'newCall', 'makeCall' etc.)
- *connection* - this parameter specifies the connection that is alerting (ringing)
- *establishedConnection* - this parameter specifies the connection that has been established
- *alertingDevice* - this parameter specifies the device that is alerting (ringing)
- *lastRedirectionDevice* - this parameter specifies a previously known redirection from device (in most cases will be used with the 'notRequired' value)

#### A list of important details:

- Subprotocol (Sec-WebSocket-Protocol header) must have the value: 'csta'
- WebSocket frames should be of the 'text' type
- Packets fragmentation has to be not applied on CSTA packets
- WebSocket clients can send WebSocket ping requests periodically and the WebSocket server should respond to it

## A connection with the ngcp-websocket

When using your own system with CSTA (presumably this can be a web platform with GUI which sends WebSocket requests of XML format), this system will have to establish a connection or a pool of connections with the ngcp-websocket component.

### NOTE

For simplicity reasons, let us name a client/system getting connected to the CSTA/ngcp-websocket as web-interface-1

Each connection between the web-interface-1 (client) and the ngcp-websocket upon establishment, requires the CSTA RequestSystemStatus message to be sent from the web-interface-1. Once a response from the ngcp-websocket is received, a session is considered to be established. Consider:

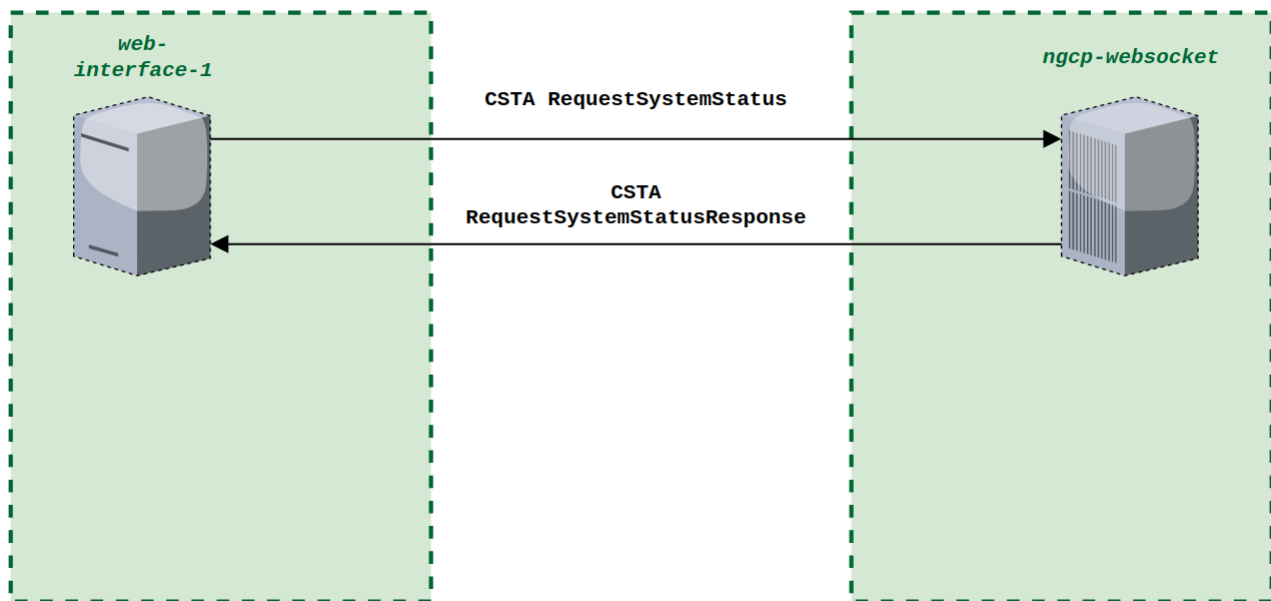

Figure 205. CSTA RequestSystemStatus messages exchange

An example of such messages exchange can be found here: [CSTA Appendix, RequestSystemStatus](#).

## Messages format

The content of CSTA messages is regulated with the ECMA-269 standard and is illustrated in the ECMA TR/82. XSD (XML Schema Definition) is described by [ECMA-323](#)

### IMPORTANT

As described in "5.2 Request/Response Protocol Requirements" of ECMA-323, the XML part does not provide mechanism for correlating a CSTA request with a CSTA response.

CSTA has a server/client model (request/answer), this is quite similar to what HTTP or SIP protocols have. The content of such message has headers and has a body. Currently only bodies in XML format are supported.

At least two headers are required and must be presented in each request/response of the WebSocket messages exchange:

- 'Content-Type:' - a content type of CSTA body, now it has only one possible value

'application/csta+xml'

- 'X-CSTA-Seq-ID:' - a sequence Id of CSTA request/response transaction. It is recommended having a unique ID within each NGCP/CSTA environment. It is incremented by 1 with every new request. For e.g.: ab234\_1, ab234\_2, ab234\_3, ... ab234\_N, where ab234 is an unique ID.

#### 8.4.4. Telephony scenarios

In this section it is described how an interaction of the CSTA and SIP environment builds up 3PCC-controlled SIP sessions. In other words, how to use the CSTA (over the WebSocket protocol) to initiate, modify and properly terminate 3PCC-controlled sessions.

##### IMPORTANT

For CSTA to operate effectively, each device in the 3PCC-controlled SIP session must be monitored.

##### NOTE

In certain scenarios, it may not be possible to monitor a remote side, for e.g. in case when a call with a remote side is established via the SIP peering/media gateway. In such situation, the monitoring can be applied to the SIP peering/media gateway as the last visible point Sipwise C5 interacts with.

#### Monitoring of device

The web-interface-1 (client) needs to start a CSTA monitor for a given SIP device in order to observe evaluations on CSTA calls via CSTA events. To start a monitoring, a CSTA MonitorStart service message is being sent (as the body of a WebSocket request). Consider:

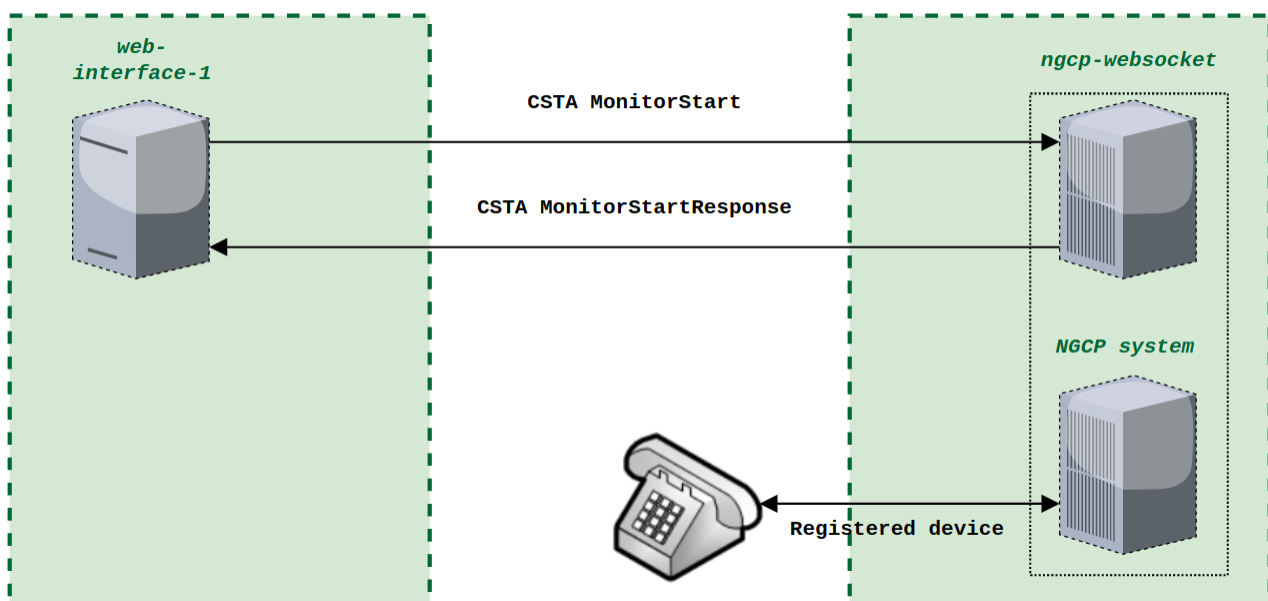

Figure 206. CSTA MonitorStart messages exchange

One can see from the figure above that the sequence is as follows:

- Monitoring is started for the device with AOR: sip:1000@sipwise.com, and a message is sent from the web-interface-1 (MonitorStart)
- SIP device gets monitored and an unique monitor ID is generated for a given response (MonitorStartResponse)

Now, any time when certain event happens to this SIP device, ngcp-websocket will notify the web-interface-1 about the ongoing event using the WebSocket message (DeliveredEvent).

An example of such messages exchange can be found here: [CSTA Appendix MonitorStart](#).

As well as a monitoring of any device can be started, it can also be stopped using the 'monitorCrossRefID', which was previously given when establishing the monitoring session using the WebSocket MonitorStart request. After it is complete, no notifications/events will be generated for a given device. Consider:

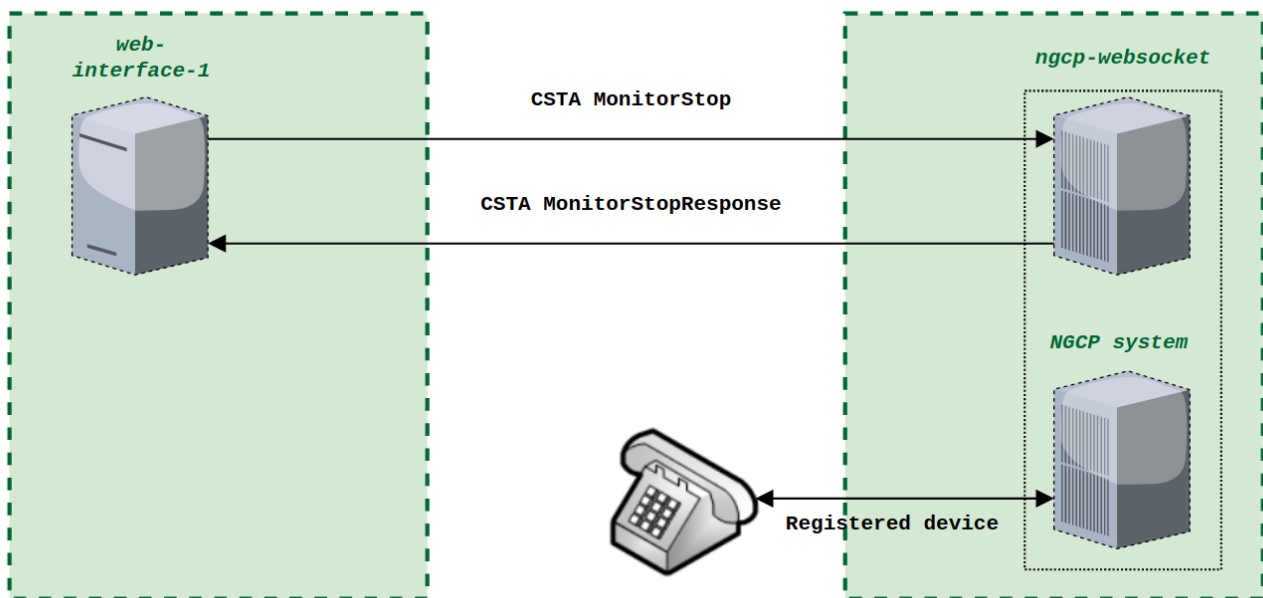

Figure 207. CSTA MonitorStop messages exchange

In some cases a particular device may be monitored by two monitors at the same time, in this situation when one of monitoring events has been stopped, the remaining one should continue delivering CSTA events.

### Aspects of user identity

The CSTA requires a user identity, which includes the SIP URI as well as a display name (if present) and must be stored using the '<deviceIdentifier>' tag in the XML body of the message, for e.g.:

```
<callingDevice><deviceIdentifier>&lt;Carol&gt;
sip:1002@company1.sipwise.com</deviceIdentifier></callingDevice>
```

It corresponds to a real user identity taken from the SIP message (from the P-Asserted-Identity):

```
P-Asserted-Identity : "Carol" <sip:1002@company1.sipwise.com>
```

#### NOTE

During the call forward type of event, once a call is established, a real/actual user identity has to be reflected in the 'P-Asserted-Identity' header of the SIP 200 OK message going to an initial caller.

**NOTE**

In case of SIP legs changes (for example a call transfer), a distant identity will likely be changed. In this case INVITE with 'Replaces' parameter should be issued to the remote leg, in order to update the current user identity.

For inbound calls to the Sipwise C5, the user identity has to be provided in the incoming SIP INVITE request and can then be reflected in the WebSocket message (so on the CSTA level) by a proper setting of the '<callingDevice>' tag value. In the case of an incoming call, such CSTA events will be of 'DeliveredEvent' type and then of 'EstablishedEvent' type (the latter, if a call got connected). The priority for a source of this value is the following:

1. the 'P-Asserted-Identity' header ;
2. the 'From' header (if PAI does not exist) ;

For outbound calls, if we have the 'P-Asserted-Identity' header in the 200 OK response coming from a remote side, it has to be reflected as the value of the '<answeredDevice>' tag in the 'EstablishedEvent' WebSocket message. If PAI is not present, then the 'To' header is a source of the value.

**Third-party call control, scenarios**

These operations are usually issued by an application (using CSTA services) and known as 3PCC operations. Let us have a look at some examples.

Here is an example of the Make Call successful session, internal call:

This scenario illustrates a successful Make Call from device A to device B.

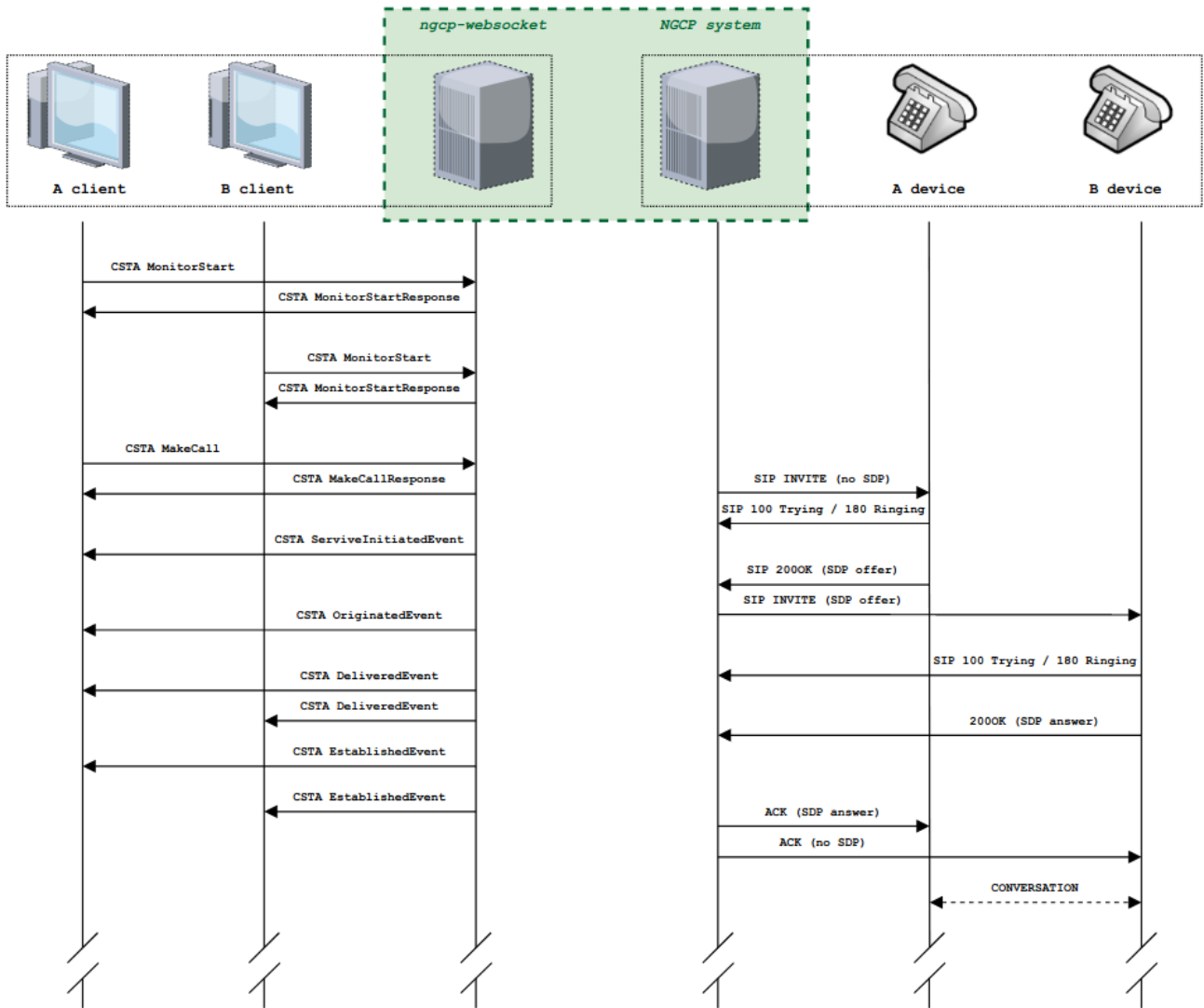

Figure 208. CSTA MakeCall messages exchange

In this scenario both devices are registered and ready to process calls. The client of A sends a request to start a SIP session with B. The client of B is notified about the incoming call. B picks up the call and the media session is established between A and B. Both clients of A and B are notified about the delivered event.

The detailed content of CSTA messages is presented [CSTA Appendix MakeCall](#).

**NOTE**

If the default list of codecs (configured in the config.yml *tpcc.codec\_list*) does not fit the requirements of the calling client, you may choose a specific list of codecs. This preference is being transferred using '<mediaSessionInfo>' XML element.

An example of the Make Call failed session, internal call:

The MakeCall scenario can fail for many reasons, this may happen for e.g. in case, when a destination or source device is busy, or one of them does not respond, not found, etc.

In the scenario shown below, device B is busy and cannot receive the call at the time of attempt to reach it.

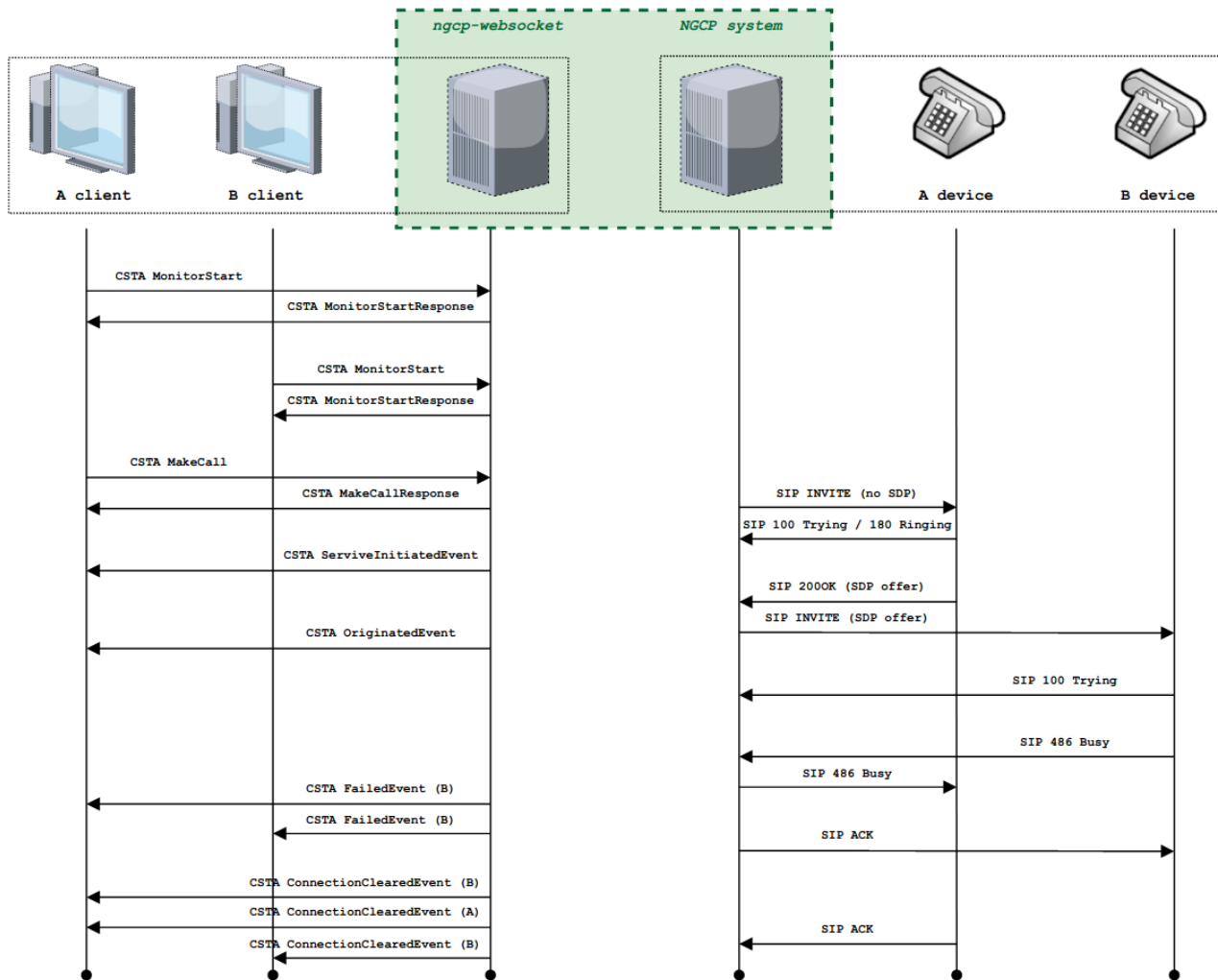

Figure 209. Failed MakeCall scenario (destination is busy)

The content of CSTA messages is presented in [CSTA Appendix MakeCall failed](#).

A treatment of other errors:

- if 'callingDevice' of MakeCall is unknown – the response to the MakeCall request will be a CSTAErrorCode with the 'invalidSourceDeviceID' error;
- if 'calledDirectoryNumber' of MakeCall is unknown – the response to the MakeCall request will be a CSTAErrorCode with the 'invalidDestinationDeviceID' error.

An example of the Make Call successful session, outbound scenario:

The following scenario illustrates the Make Call service request from behalf of device A to an external device which is outside of the served domain.

Since the destination is located outside this CSTA domain, it cannot be directly monitored via the CSTA API and therefore no events can be generated for the remote side. Since the remote device is reachable via a SIP peering, this SIP peering technically represents a SIP endpoint visible for the system, and hence, can be instead monitored by the CSTA, since this SIP Peering is directly handled by the Sipwise C5. But this is not required.

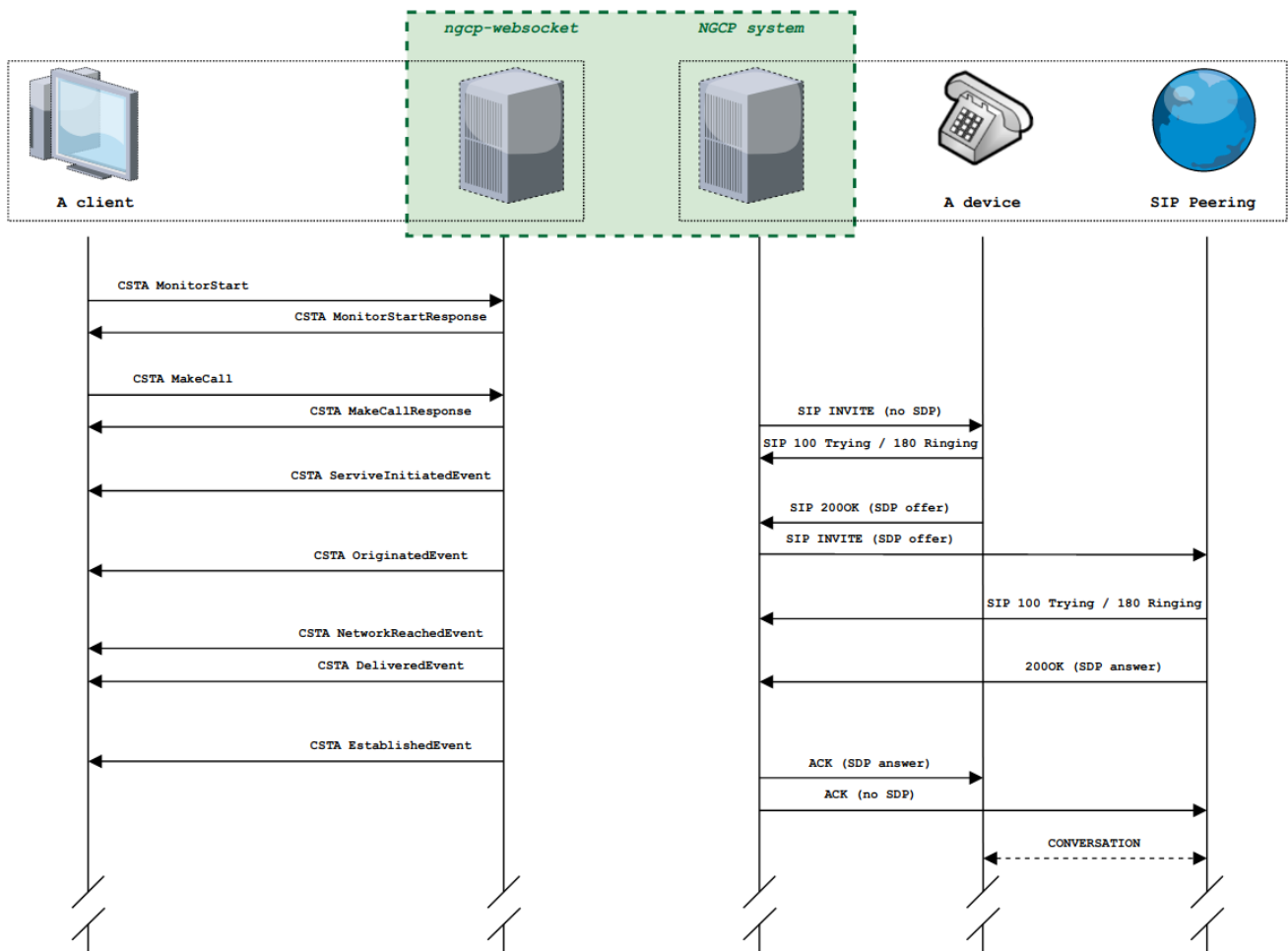

Figure 210. CSTA MakeCall with a SIP Peering, messages exchange

The content of CSTA messages is presented in [CSTA Appendix MakeCall outbound](#).

A treatment of other errors:

- if the 'callingDevice' of MakeCall is unknown – the response to the MakeCall is 'CSTAErrorCode' with the 'invalidSourceDeviceID' error;
- if the 'calledDirectoryNumber' of MakeCall is unknown – the response to the MakeCall is 'CSTAErrorCode' with the 'invalidDestinationDeviceID' error.

For outbound calls, if there is the 'P-Asserted-Identity' in the SIP 200OK coming from a distant participant, it has to be reflected in the 'answeredDevice' XML element of CSTA 'EstablishedEvent' event message.

An example of the Hold Call scenario:

This scenario illustrates a successful Hold Call request processing. A hold request is issued by a client and then a SIP re-INVITE transaction with the special content of SDP body will be sent to the remote side (sendonly / inactive / 0.0.0.0).

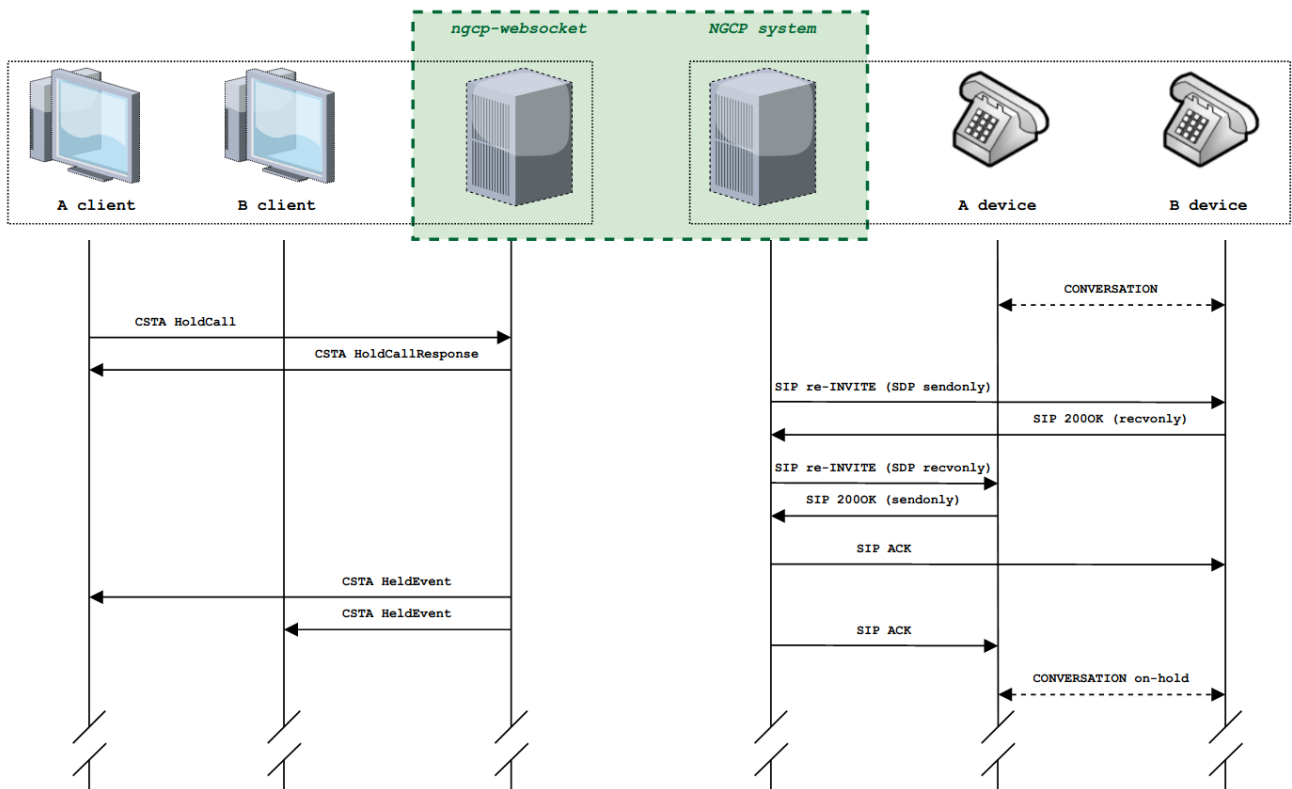

Figure 211. CSTA MakeCall with a SIP Peering, messages exchange

The content of CSTA messages is presented in [CSTA Appendix HoldCall](#).

A treatment of errors:

- if a connection in the 'callToBeHeld' of HoldCall is unknown – the response to the HoldCall request is the 'CSTAErrorCode' with the 'invalidConnectionID' error;
- if a connection of HoldCall is not in the 'connected' state – the response to the HoldCall request is the 'CSTAErrorCode' with the 'invalidConnectionState' error.

An example of the Retrieve call:

This scenario illustrates a successful Retrieve request processing. A prerequisite - SIP call must be on hold. After the retrieve operation, a conversation is to be continued.

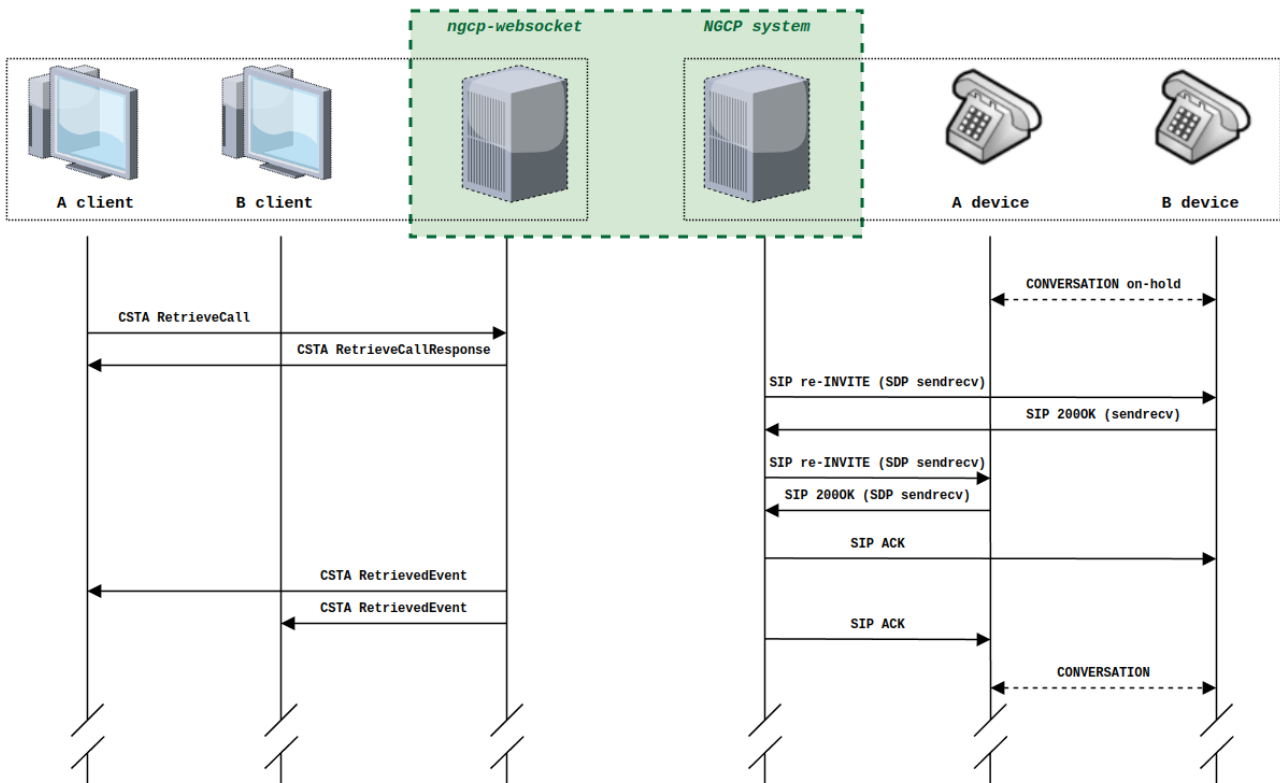

Figure 212. Successful RetrieveCall scenario using SIP re-INVITE

The content of CSTA messages is presented in [CSTA Appendix RetrieveCall](#).

A treatment of errors:

- if a connection in the 'heldCall' of the 'RetrieveCall' is unknown – a response to the 'RetrieveCall' is the 'CSTAErrorCode' with the 'invalidConnectionID' error;
- if a connection in the 'heldCall' of the 'RetrieveCall' is not in the 'held' state – a response to the 'RetrieveCall' is the 'CSTAErrorCode' with the 'invalidConnectionState' error.

An example of the Clear Connection:

This scenario illustrates how a normal call clearing (call termination) occurs. A session with a remaining device is cleared as well.

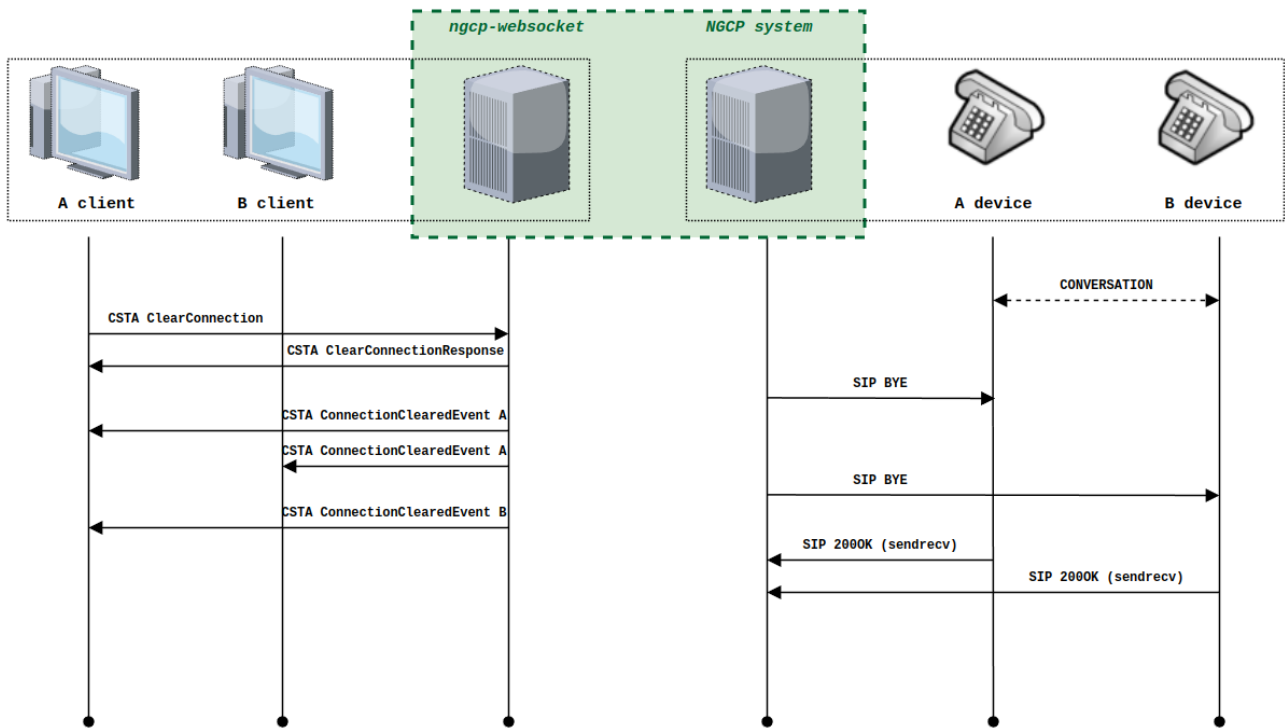

Figure 213. Successful ClearConnection scenario

The content of CSTA messages is presented in [CSTA Appendix ClearConnection](#).

A treatment of errors:

- if a connection in the 'connectionToBeCleared' of the 'ClearConnection' is unknown – a response to the 'ClearConnection' is the 'CSTAErrorCode' with the 'invalidConnectionID' error ;
- if a connection in the 'connectionToBeCleared' of the 'ClearConnection' is in the 'Null' state – a response to the 'ClearConnection' is the 'CSTAErrorCode' with the 'invalidConnectionState' error.

### Third-party call control, other scenarios not described in the handbook

- ClearCall
- DeflectCall
- ConsultationCall
- SingleStepTransferCall
- TransferCall

### Third-party call control, retrieve information about device / call

SnapshotCall:

An application uses the SnapshotCall service to obtain information about the CSTA connections of the particular call and supplementary information, like a CallingDevice, CalledDevice, etc.

The ngcp-websocket will provide a positive response with the list of zero or more connections and information about each connection as well as supplementary information.

A list of common elements in the `snapshotDeviceResponseInfo` element:

- `<deviceOnCall>` – this mandatory element contains the endpoint device ID ;
- `<connectionIdentifier>` – this mandatory element provides the 'connectionID' of the connection. This is the 'connectionID' that is used in CSTA services that are applied to the connection. The `<connectionIdentifier>` is combined of the `called` and the `deviceID`. The `deviceID` `<privateNumber>`' attribute may be set to true in case of privacy (CLIR/COLR) ;
- `<localCallState>` – this mandatory element specifies a 'compoundCallState', which consists of one or more CSTA connection states. The first connection state in the list is the 'local' connection state of the connection being reported. Other connection states that reflect other connections in the same call (rest of devices) may also be provided, if known to the UAC ;
- `<calling>/<called>` – a calling called device ;
- `<privateData>` – an additional information about the call state: recorded connections, display names ;

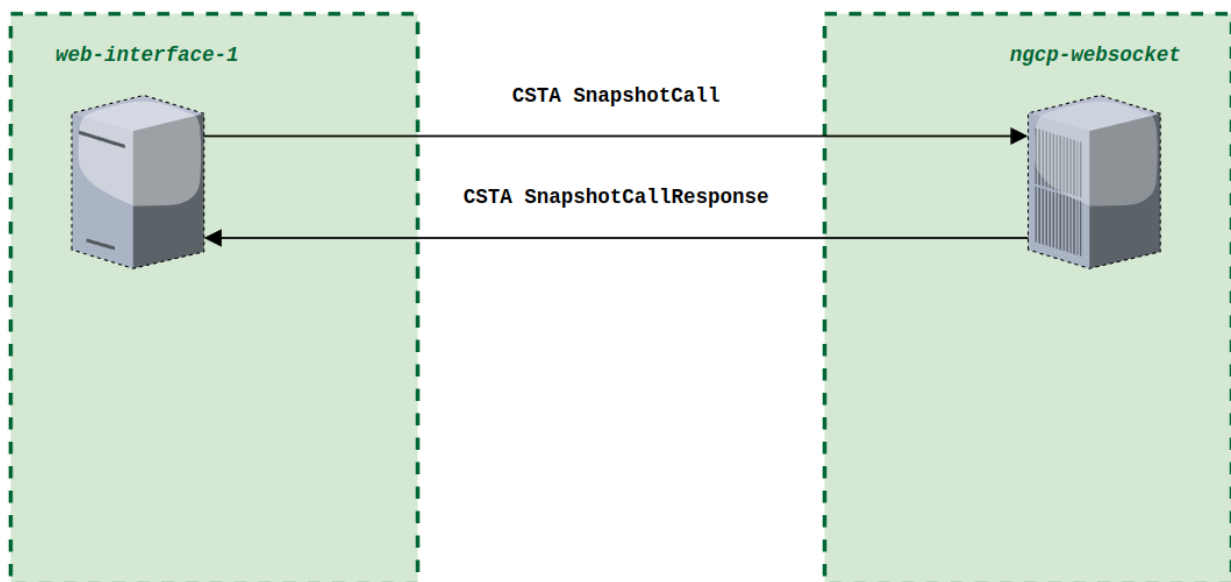

Figure 214. Snapshot Call scenario

If a SIP call does not exist, a response with the 'CSTAErrorCode' is returned to the 'SnapshotCall' with the 'invalidCallID' status.

SnapshotDevice:

An application uses the SnapshotCall service to obtain information about the CSTA connections of the particular device.

The ngcp-websocket service will provide a positive response with the connection details.

- `<deviceOnCall>` – this mandatory element contains the endpoint device ID ;
- `<connectionIdentifier>` – this mandatory element provides the 'connectionID' of the connection. This is the 'connectionID' that is used in CSTA services that are applied to the connection. The `<connectionIdentifier>` is combined of the `called` and the `deviceID`. The `deviceID` `<privateNumber>`'

attribute may be set to true in case of privacy (CLIR/COLR) ;

- `<localCallState>` – this mandatory element specifies a 'compoundCallState', which consists of one or more CSTA connection states. The first connection state in the list is the 'local' connection state of the connection being reported. Other connection states that reflect other connections in the same call (rest of devices) may also be provided, if known to the UAC ;
- `<calling>/<called>` – a calling called device ;
- `<privateData>` – an additional information about the call state: recorded connections, display names ;

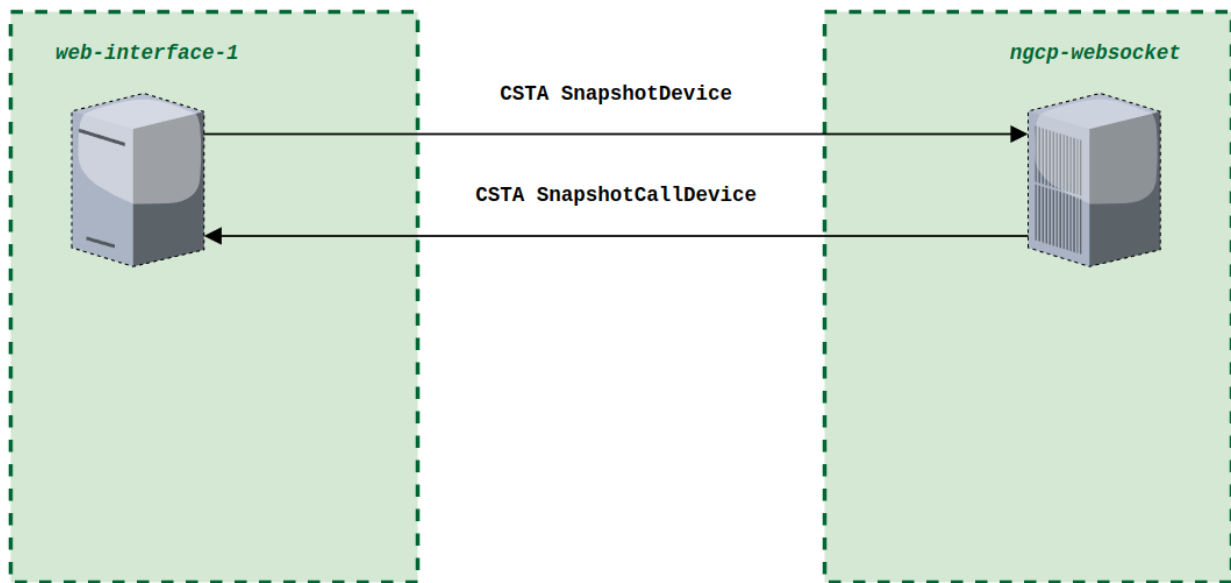

Figure 215. Snapshot Call scenario for a device

If a requested device is for any reason out-of-service, a response with the 'CSTAErrorCode' is returned to the 'SnapshotDevice' with the 'deviceOutOfService' status.

### Third-party call control, device got into/out of service

BackInService:

The 'BackInService' event indicates that a device has been returned to service and is available. Back into service means one of the following: SIP device register / configuration object enabled / out-of-service check with success result.

#### NOTE

'BackInService' does not need to be sent upon SIP REGISTER refresh, only upon initial REGISTER.

OutOfService:

The 'OutOfService' event indicates that a device has entered a maintenance or a disabled state (for e.g. has been de-registered) and can no longer accept calls and some other categories of CSTA service requests (for e.g. Call Control services).

Out of service means one of the following: SIP device de-register / configuration object disabled / out-

of-service check with failed result.

### 8.4.5. 3PCC (TPCC) module of sems-b2b component

This is a module which allows to establish different call events, such as usual audio session between two points, based on the websocket/CSTA generated commands.

The main goal of the 3PCC (TPCC) SEMS module is to have an interconnection between the internal ngcp-websocket component and the SEMS-b2b in terms of translating actions to real call sessions (create call, hang-up, put on hold, transfer call etc.)

Two abstract (logical) endpoints that we have in such an architecture:

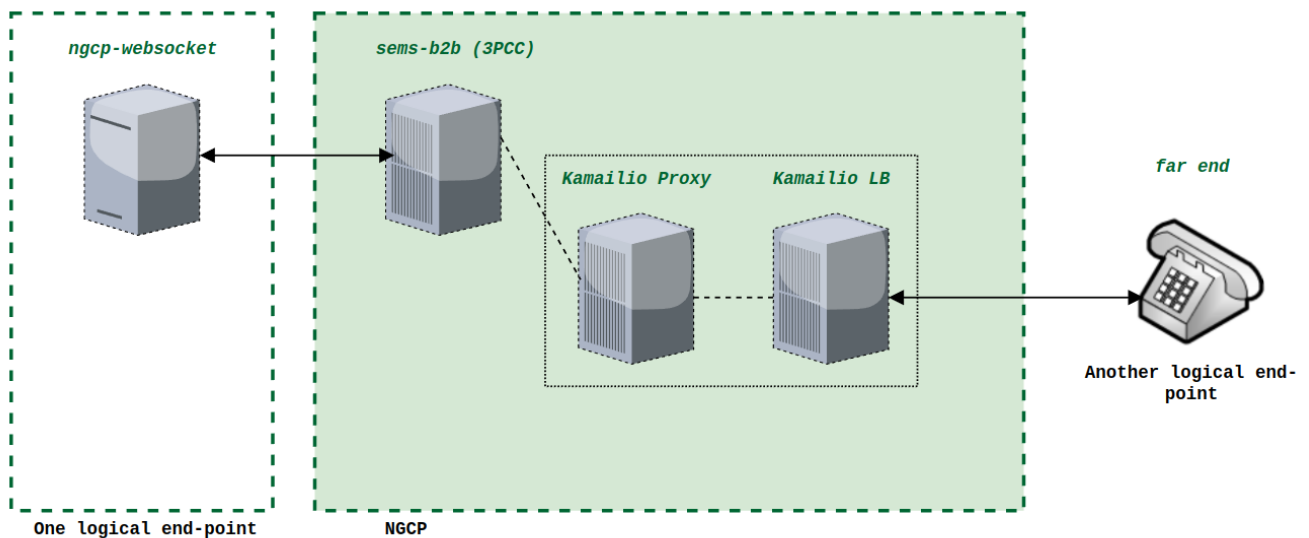

Figure 216. Two logical endpoints in the architecture

#### Interaction with the ngcp-websocket

The ngcp-websocket communicates with the CSTA environment (CSTA events) and translates this logic into the internal communication environment:

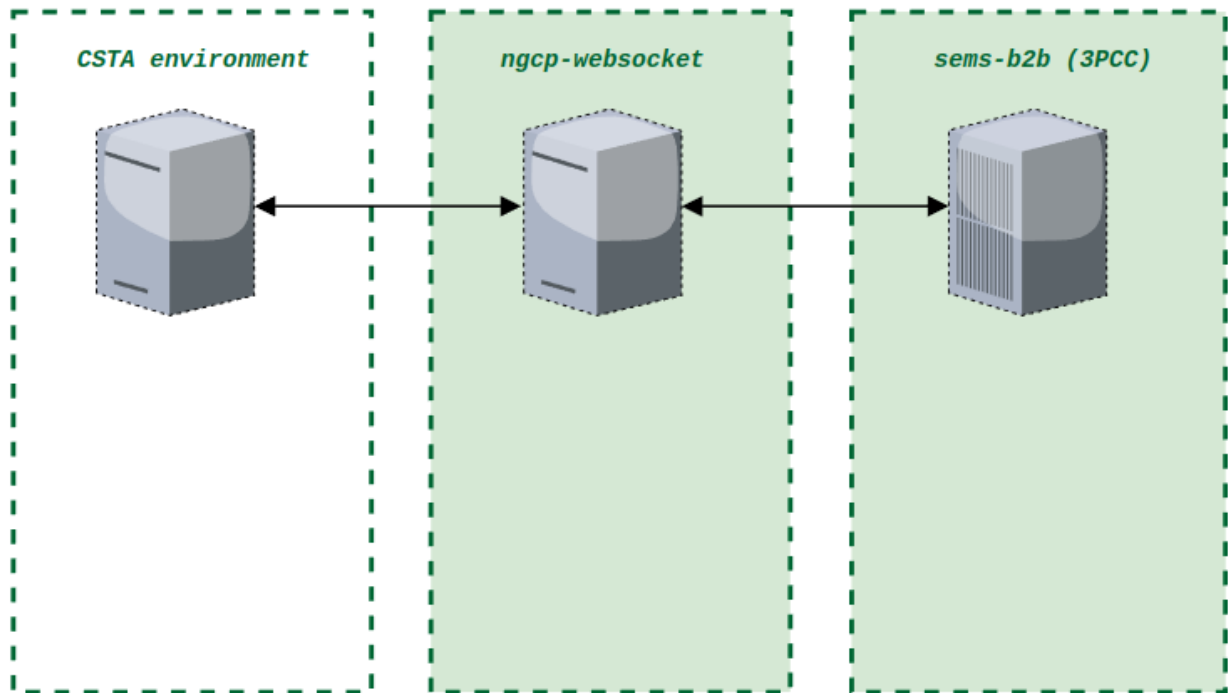

Figure 217. CSTA environment with SEMS

The ngcp-websocket communicates with the SEMS using specified (our internal) protocol (sending/receiving messages to/from SEMS). The communication between the web-socket and the SEMS is implemented using Redis channels (Redis queues).

**NOTE**

The aim is to communicate via these channels also with other components, such as Kamailio Proxy.

This approach currently supports multi-nodes distributed environment. In scope of this chapter our interest is SEMS-b2b component.

### Redis-channels (Valkey)

The SEMS-b2b component is currently using at least three Redis channels:

- Receiving Data (actions): 1) Subscription Channel (as a command interface), 2) Events Channel (for data)
- Sending Data (updates / brand new SIP events): 1) Publish Channel (responses to the channel, or new requests to the channel)

**NOTE**

Sometimes Redis channels can be also called as Redis queues.

By default it is been set to:

- receiving commands via the 'csta.websocket' channel (separate thread in SEMS)
- receiving any data additional via the 'sp.sems-b2b' channel (parent thread)
- sending data to the channel 'csta.sems'

**IMPORTANT**

The names of the channels can be controlled accordingly in the `tpcc.conf` of the `sems-b2b` component. Parameters: `'subscribe_channel'`, `'publish_channel'` and `'output_dst'`. If for any reason there is a rational need to change the names of these channels, please contact the Sipwise Operations team to get a consultation.

It is worth mentioning that in the multi-active setup with multiple `SEMS-b2b` components working simultaneously the `'subscribe_channel'` and the `'output_dst'` values will be set based on the hostnames. This allows to differentiate messages being sent from/to Redis channels between different `SEMS-b2b` instances.

**SEMS component of Sipwise C5**

The `SEMS` is working asynchronously (multi-threaded program). Inside the `SEMS` we have two main queues:

- coming commands > FIFO input > 3PCC (TPCC) Handler (multi-threaded)
- responses / outgoing requests > FIFO output > 3PCC (TPCC) Handler (multi-threaded)

The `SEMS-b2b` constantly sends keepalive messages (just dummy 'ping') to remote Redis (Valkey) to keep connections with the Redis (Valkey) alive.

It also has a multi-threaded processing of incoming/outgoing commands (FIFO). It picks an incoming message (command/metadata) from the input queue and passes it to its events processor. It also picks any pending messages in the output queue, serializes it into the text (JSON) representation and publishes it to an according Redis channel.

The events processor of `SEMS` will try to undertake something upon receiving of the command. Logically we can divide it into two categories of actions:

- make a call between two participants. That means it calls an initiator (we can call it leg A) and then it calls the recipient of the call (we can call it leg B), and it calls it from behalf of the A side.
- perform an action on an existing session (as a simple example - we can hang-up it)

It is also worth mentioning another aspect of 3PCC handling - events happening on the SIP side of 3PCC session.

All things happening within the SIP session (not triggered by the 3PCC handling), will be reflected accordingly on the 3PCC/CSTA. This means, `SEMS-b2b` will do all the required work to notify the `ngcp-websocket` component of SIP messages received during an existing SIP session (re-INVITE for e.g.).

Here is a useful sequence description of the 3PCC dialog initiation:

- the `CSTA` environment sends some command in the XML to the `ngcp-websocket` component;
- the `ngcp-websocket` translates it to the internal protocol and puts the message in the JSON format into the dedicated Redis channel (Subscription Events / Events Redis);
- the `SEMS-b2b` component receives this JSON message from Redis (Valkey), parses it and translates it into the internal `SEMS-b2b` program usage (in other words make it convertible into c++ objects, hence machine code)
- the `SEMS-b2b` starts processing the command using its events processor mechanism and will undertake all required actions, if they are applicable;

As a simple example of such event processing is a call from A-to-B. In such call scenario SEMS-b2b invites A without an SDP body present (no offer), waits until A responds with 200OK containing an SDP offer with certain media capabilities, and then will use these capabilities to build up an SDP offer to be sent to the B subscriber.

B gets invited into the SIP call, as soon as the call is accepted by B, the SDP answer contained by the 200OK response will be used to build up an SDP answer for A as well. Eventually this session gets acknowledged by SEMS for B (leg with B), and by A. A media session is established then through the SEMS-b2b and if needed, transcoding is to be applied.

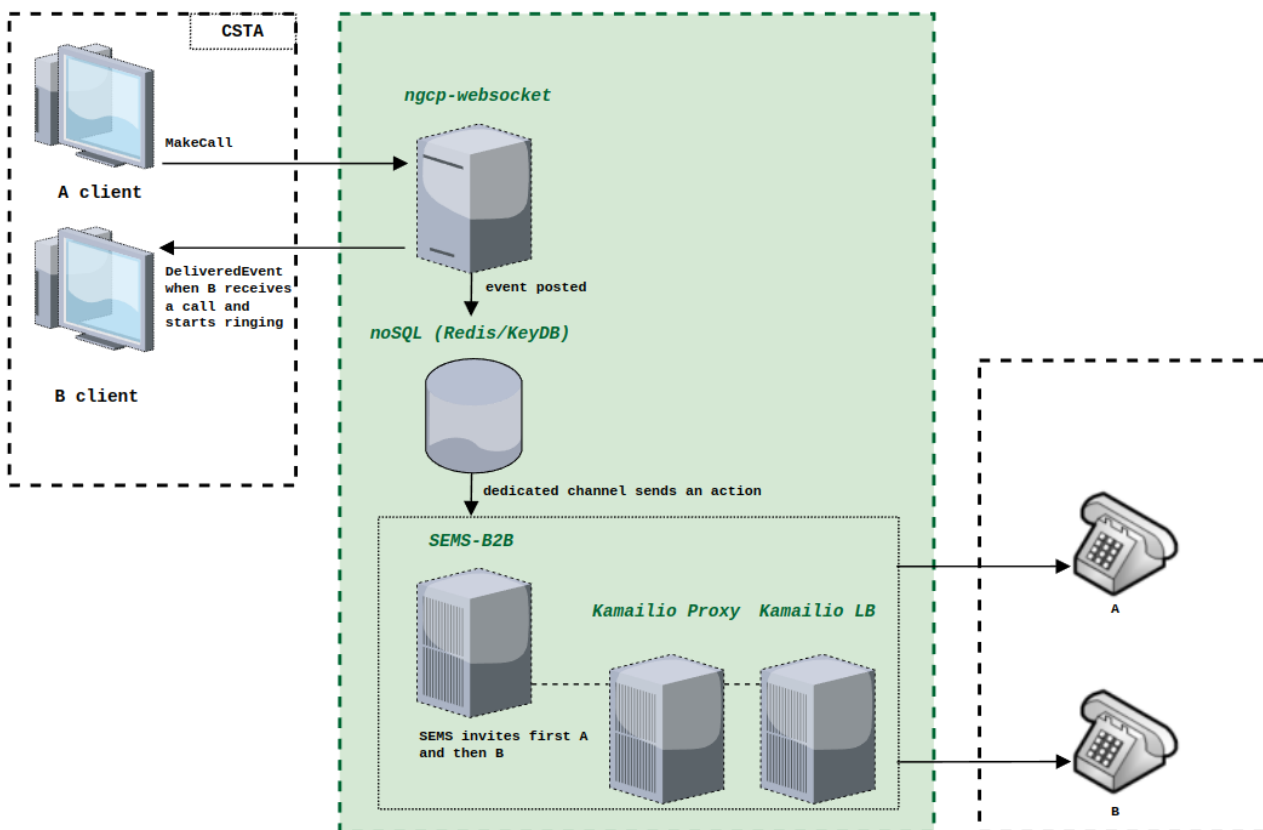

Figure 218. 3PCC dialog initiation

#### NOTE

In case there is more than one active SEMS component working in the cluster, for e.g. Carrier grade setup, then the first SEMS who received and started processing this JSON message (new event), is responsible for this particular TPCC session. A very first SEMS-b2b, which has received this message, will RPOP this event from the end of the dedicated Redis list (channel) and will start processing it. Hence other active SEMS-b2b instances in the cluster, will not undertake anything.

### 8.4.6. Configuration of 3PCC (TPCC)

To start using 3PCC/CSTA functionality of the Sipwise C5 the following list of config.yml parameters must be activated:

- `tpcc.enable` *yes*
- `websocket.enable` *yes*

Detailed example of 3PCC (TPCC) config.yml block:

```
tpcc:
  add_header_to_detect_device: ''
  codec_list: PCMA,PCMU,g729,opus,g722
  enable: no
  instance_id: '*'
  publish_channel: csta.sems
  use_broadsoft_hold: no
```

Where:

- *add\_header\_to\_detect\_device*: - this option defines, which header to add into the 3PCC originated calls in order to notify the caller/callee subscriber, who is the real device involved in the call
- *codec\_list*: - a list of preferred audio codecs
- *enable*: - enabling of the 3PCC (TPCC) module
- *instance\_id*: - identification of the sems instance, only for the multi-active sems setup
- *publish\_channel*: - a channel to be used for publishing 3PCC events
- *use\_broadsoft\_hold*: - use it to switch between initial and broadsoft-specific hold handling

```
websocket:
  allow_foreign_monitor_stop: yes
  enable: no
  inactivity_timeout: 0
  loglevel: info
  max_clients: 1000
  max_requests: 100
  mode: development
  port: 3443
  redis:
    csta_monitor_db: 31
    csta_publish_channel: csta.websocket
    csta_subscribe_channels:
      - csta.sems
      - csta.proxy
    csta_subscription_db: 32
  ssl:
    cert: /etc/ngcp-config/shared-files/ssl/myserver.crt
    enable: no
    key: /etc/ngcp-config/shared-files/ssl/myserver.key
```

Where:

- *allow\_foreign\_monitor\_stop*: - enable/disable MonitorStop with the 'monitor\_id' belonging to another connection
- *enable*: - an enabling of the websocket component

- *inactivity\_timeout*: - a timeout for the remote side in case of actions absence
- *loglevel*: - the log level for the component
- *max\_clients*: - a maximum amount of clients can be processed simultaneously
- *max\_requests*: - a maximum amount of requests can be processed simultaneously
- *mode*: - possible values 'full', 'development' and 'brief'
- *port*: - the port to listen on
- *redis*: - a block of options related to Redis (Valkey)
- *redis.csta\_monitor\_db*: - select needed db for the monitor
- *redis.csta\_publish\_channel*: - a Redis channel for publishing events
- *redis.csta\_subscribe\_channels*: - Redis channels to which sems-b2b and kamailio-proxy will subscribe
- *redis.csta\_subscription\_db*: - select needed db for publishing events
- *ssl*: - a block of options related to the SSL encryption
- *ssl.enable*: - enable SSL encryption
- *ssl.cert*: - a path to the certificate
- *ssl.key*: - a path to the key

After both '*tpcc.enable*' and '*websocket.enable*' config.yml options are set to *yes*, changes must be applied with the following:

```
ngcpcfg apply 'enable tpcc and websocket'
```

### IMPORTANT

by enabling these options a restart of the sems-b2b and kamailio-proxy services will be triggered, so it's better to plan this maintenance out of business hours. If there are any doubts regarding how to properly enable CSTA/3PCC support in the system, please contact the Operations team of Sipwise.

After both the 3PCC (TPCC) module and the ngcp-websocket component are enabled you can start using the API to issue new 3PCC-controlled SIP calls.

## 8.5. Phone Voice Quality Reporting

The support for RFC6035 can be achieved by setting the parameter `kamailio.proxy.vqr.enable` to "yes" in config.yml. This allows Sipwise C5 to be able to collect PUBLISH messages from the call parties carrying the voice quality reporting as described in RFC6035. Some SIP deskphones, in fact, implements a way to send a quality report at the end of a call by sending an unsolicited and unauthorized PUBLISH message such as the example below:

```
PUBLISH sip:quality@<ngcp_ip>;transport=tcp SIP/2.0
Accept: application/csta+xml
Via: SIP/2.0/TCP <deskphone_IP>;branch=z9hG4bK24329ea40029aeb38
Max-Forwards: 70
From: "Master Yoda" <sip:104@<ngcp_ip>;tag=c978aefb00
```

```

To: <sip:quality@<ngcp_ip>;transport=tcp>
Call-ID: ada11c62
CSeq: 834762177 PUBLISH
Allow: ACK, BYE, CANCEL, INFO, INVITE, MESSAGE, NOTIFY, OPTIONS, PRACK,
PUBLISH, REFER, REGISTER, SUBSCRIBE, UPDATE
Allow-Events: conference, refer
Contact: <sip:104@<deskphone_IP>:5060>
Event: vq-rtcpxr
Expires: 3600
Supported: 100rel, eventlist, join, replaces, sdp-anat, tdialog, timer
Content-Type: application/vq-rtcpxr
Content-Length: 1258

```

```
VQSessionReport:CallTerm
```

```
LocalMetrics:
```

```

Timestamps:START=2023-10-27T07:43:36Z STOP=2023-10-27T07:43:54Z
SessionDesc:PT=8 PD=G711_A64k SR=16000 FD=10 FO=160 FPP=2 PPS=100
FMTP="annexb=no" PLC=128 SSUP=off
LocalAddr:IP=0.0.0.0 PORT=6000 SSRC=0x4c47ae4d
RemoteAddr:IP=<ngcp_ip> PORT=4008 SSRC=0x706f0742
JitterBuffer:JBA=48 JBR=6 JBN=10 JBM=240 JBX=320
PacketLoss:NLR=0 JDR=0
BurstGapLoss:BLD=0 BD=0 GLD=0 GD=4990 GMIN=3
Delay:RTD=4 ESD=162
Signal:SL=-20 NL=-41 RERL=120
QualityEst:RLQ=0 RCQ=80 EXTRI=0 MOSLQ=4.200 MOSCQ=4.000 QoEEstAlg=P.564
CallID:0a97905c
FromID:"Master Yoda" <sip:104@<ngcp_ip>>
ToID:"100" <sip:100@<ngcp_ip>>

```

```
RemoteMetrics:
```

```

Timestamps:START=2023-10-27T07:43:36Z STOP=2023-10-27T07:43:54Z
SessionDesc:PT=8 PD=G711_A64k SR=16000 FD=10 FO=160 FPP=2 PPS=100
FMTP="annexb=no" PLC=0 SSUP=off
LocalAddr:IP=<ngcp_ip> PORT=4008 SSRC=0x706f0742
RemoteAddr:IP=0.0.0.0 PORT=6000 SSRC=0x4c47ae4d
JitterBuffer:JBA=0 JBR=0 JBN=0 JBM=0 JBX=0
PacketLoss:NLR=0 JDR=0
BurstGapLoss:BLD=0 BD=0 GLD=0 GD=0 GMIN=0
Delay:RTD=0 ESD=0
Signal:SL=0 NL=0 RERL=0
QualityEst:RLQ=0 RCQ=0 EXTRI=0 MOSLQ=0.000 MOSCQ=0.000 QoEEstAlg=P.564
CallID:0a97905c
DialogID:0a97905c;from-tag=20f6e523a0;to-
tag=KDbc1uVQTKlQGU0JmWkrny3xx1p.CLga

```

The unauthorized PUBLISH message is sent to the "sip:quality@<ngcp\_ip>" R-URI which can be set on the deskphone side as well as on the Sipwise C5 by adjusting the config.yml parameter kamailio.proxy.vqr.publish\_collector\_username. By default the collector name is set to "quality". It contains the Event header set to "vq-rtcpxr" and it provides the "vq-rtcpxr" Content as described in the RFC6035, with the Local Metrics section and the Remote Metric section. The Sipwise C5 will fetch the content and save it into the database in order to be able to extract the QualityEst data from Local

metrics and Remote Metrics, correlates that with the corresponding CDR and add the MOSCQ value in the csv-exported CDR. In order to do that a configuration is required in config.yml under cdrexport section. Please contact the Sipwise support to adjust this configuration according to your requirements.

## 8.6. SMS (Short Message Service) on Sipwise C5

The Sipwise C5 offers *short messaging service* to its local subscribers. The implementation is based on a widely used software module: *Kannel*, and it needs to interact with a mobile operator's SMSC in order to send and receive SMs for the local subscribers. The data exchange with SMSC uses the *SMPP* (Short Message Peer-to-Peer) protocol.

### SMS directions:

- incoming / received: the destination of the SM is a local subscriber on the NGCP
- outgoing / sent: the SM is submitted by a local subscriber

#### NOTE

The Sipwise C5 behaves as a short message client towards the SMSC of a mobile operator. This means every outgoing SM will be forwarded to the SMSC, and every incoming SM will reach the Sipwise C5 through an SMSC.

The architecture of the SMS components of Sipwise C5 and their interaction with other elements is depicted below:

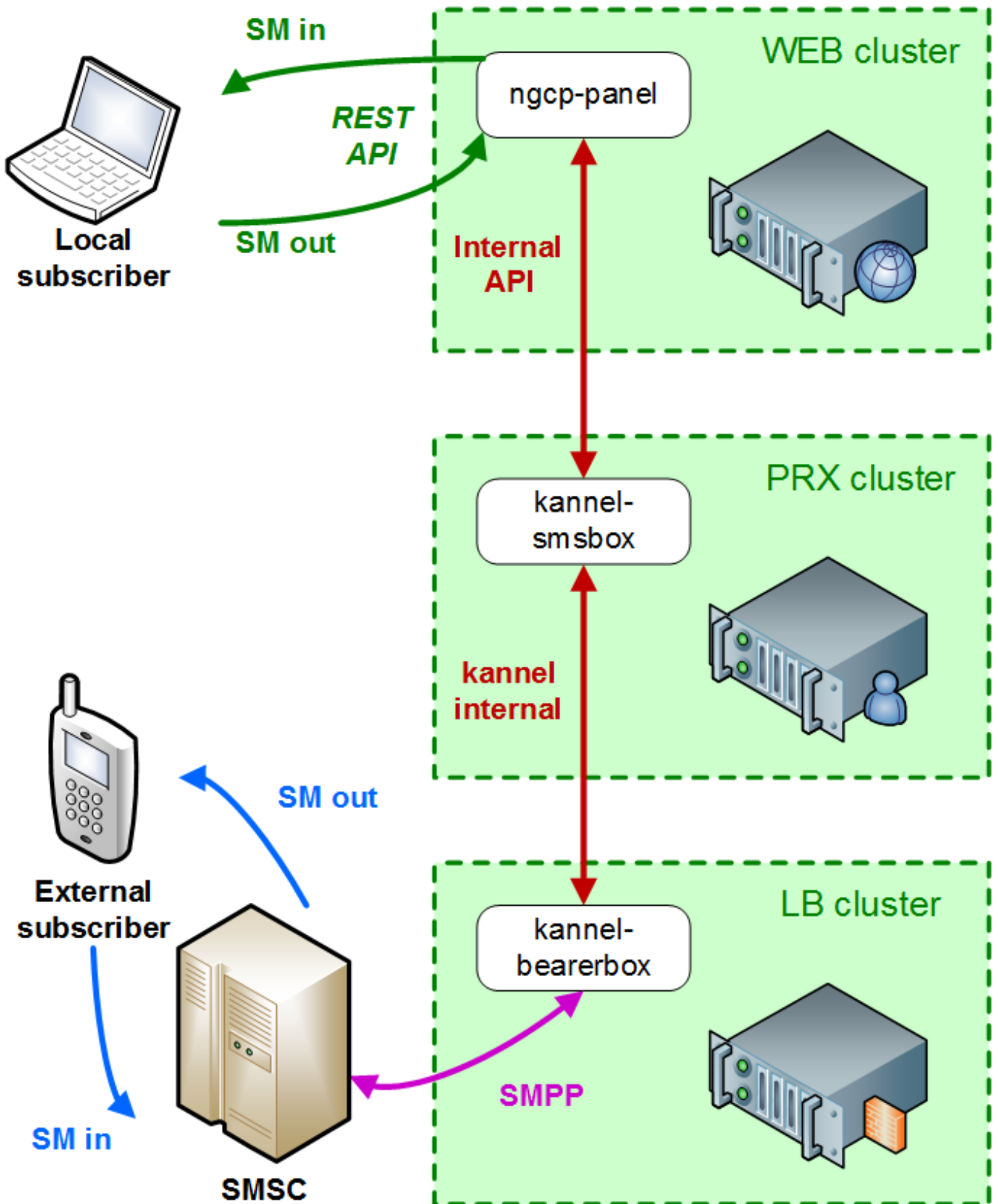

Figure 219. SMS Interaction

**NOTE**

For the Sipwise C5 CE and PRO installations: the Kannel components and the ngcp-panel all run on the same single node. The description of SMS module will continue referring to a Sipwise C5 CARRIER installation in the handbook.

There are 2 components of the SMS module:

- **SMS Box:** this component takes care of handling the messages locally, that means:
  - delivering them to subscribers (writing into database for later retrieval)
  - picking up the submitted SMSs from the database and forwarding them to the *Bearer Box* component
- **Bearer Box:** this component manages the transmission of SMSs between Sipwise C5 and the mobile operator's SMSC

### 8.6.1. Configuration

#### Main Parameters

The SMS functionality of Sipwise C5 is disabled by default. In order to **enable SMS**, change the value of configuration parameter `sms.enable` to `yes` in the main configuration file (`/etc/ngcp-config/config.yml`).

The second step of configuration is related to the **SMSC** where the Sipwise C5 will connect to. Set the following parameters:

- `sms.smsc.host`: IP address of the SMSC
- `sms.smsc.port`: Port number of the SMSC
- `sms.smsc.username`: Username for authentication on the SMSC
- `sms.smsc.password`: Password for authentication on the SMSC

Other parameters of the SMSC connection may also need to be changed from the default values, but this is specific to each deployment.

Then make the new configuration active:

```
$ ngcpcfg apply 'Enabled SMS'
$ ngcpcfg push all
```

#### Configuration Files of Kannel

There are a few configuration files for the *Kannel* module, namely:

- `/etc/default/ngcp-kannel`: determines which components of *Kannel* will be started. This is auto-generated from `/etc/ngcp-config/templates/etc/default/ngcp-kannel.tt2` file when SMS is enabled.
- `/etc/kannel/kannel.conf`: contains detailed configuration of *Kannel* components. This is auto-generated from `/etc/ngcp-config/templates/etc/kannel/kannel.conf.tt2` file when SMS is enabled.
- `/etc/logrotate.d/ngcp-kannel.conf`: configuration of *logrotate* for *Kannel* log files. This is auto-generated from `/etc/ngcp-config/templates/etc/logrotate.d/ngcp-kannel.conf.tt2` file when SMS is enabled.

#### CAUTION

Please do not change settings in the above mentioned template files, unless you have to tailor *Kannel* settings to your specific needs!

Finally: see the description of each configuration parameter in the [Appendix](#).

## Call Forwarding for SMS (CFS)

Any subscriber registered on the Sipwise C5 can apply a call forwarding setting for short messages, referred to as "CFS" (Call Forward - SMS). If the CFS feature is enabled, they can receive the SMs on their mobile phone, for example, instead of retrieving the SMs through the REST API. This is much more convenient for users if they do not have an application on their smartphone or computer that could manage the SMs through the REST API.

In order to enable CFS you have to set the forwarding as usual on the admin web interface, or through the REST API. Navigate to **Subscribers** select the three dots **Details** **Call Forwarding** and press the **Edit** button on the **Call Forward SMS** row. There you can put the destination number where the SM has to be forwarded.

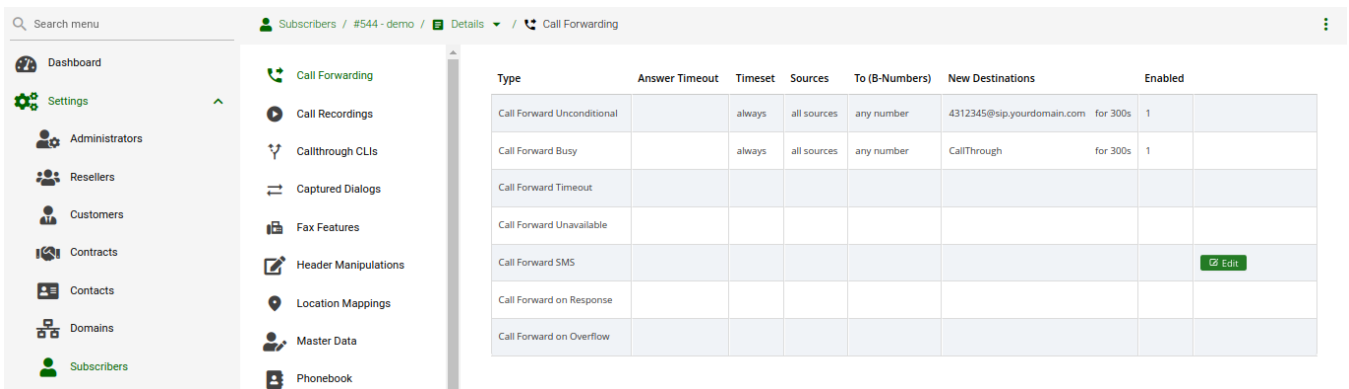

Type	Answer Timeout	Timeset	Sources	To (B-Numbers)	New Destinations	Enabled
Call Forward Unconditional		always	all sources	any number	4312345@sip.yourdomain.com for 300s	1
Call Forward Busy		always	all sources	any number	CallThrough for 300s	1
Call Forward Timeout						
Call Forward Unavailable						
Call Forward SMS						<a href="#">Edit</a>
Call Forward on Response						
Call Forward on Overflow						

Figure 220. Call Forward for SMS

## 8.6.2. Monitoring, troubleshooting

### Bearer Box (LB node of NGCP)

On the LB node you can see a **process** named **"bearerbox"**. This process has 2 **listening ports** assigned to it:

- 13000: this is the generic *Kannel* administration port, that belongs to the "core" component of Kannel.
- 13001: this is the communication port towards the *SMS Box* component running on PRX nodes of NGCP.

The *ngcp-service* tool also shows the *bearerbox* process in its summary information:

```
$ ngcp-service summary
Ok Service                Managed   Started   Status
-----
...   kannel-bearerbox       managed  by-ha    active
...
```

The following log files can provide information about the operation of *Bearer Box*:

- status messages and high level, short entries about sent and received messages:  
/var/log/ngcp/kannel/kannel.log

```

...
2017-09-26 08:57:32 [15922] [10] DEBUG: boxc_receiver: heartbeat with
load value 0 received
...
2017-09-26 11:12:06 [15922] [10] DEBUG: boxc_receiver: sms received
2017-09-26 11:12:06 [15922] [10] DEBUG: send_msg: sending msg to box:
<192.168.1.4>
2017-09-26 11:12:06 [15922] [11] DEBUG: send_msg: sending msg to box:
<192.168.1.4>
2017-09-26 11:12:06 [15922] [11] DEBUG: boxc_sender: sent message to
<192.168.1.4>
2017-09-26 11:12:06 [15922] [10] DEBUG: boxc_receiver: got ack
...

```

- detailed information and message content of sent and received messages, link enquiries:  
/var/log/kannel/smsc.log

**NOTE**

Sent and received message examples shown here do not contain the full phone number and content for confidentiality reason.

Example received message:

```

...
2017-09-26 12:09:36 [15922] [6] DEBUG: SMPP[default_smsc]: Got PDU:
2017-09-26 12:09:36 [15922] [6] DEBUG: SMPP PDU 0x7f2274025070
dump:
2017-09-26 12:09:36 [15922] [6] DEBUG:   type_name: deliver_sm
2017-09-26 12:09:36 [15922] [6] DEBUG:   command_id: 5 = 0x00000005
2017-09-26 12:09:36 [15922] [6] DEBUG:   command_status: 0 =
0x00000000
2017-09-26 12:09:36 [15922] [6] DEBUG:   sequence_number: 11867393
= 0x00b51501
2017-09-26 12:09:36 [15922] [6] DEBUG:   service_type: NULL
2017-09-26 12:09:36 [15922] [6] DEBUG:   source_addr_ton: 2 =
0x00000002
2017-09-26 12:09:36 [15922] [6] DEBUG:   source_addr_npi: 1 =
0x00000001
2017-09-26 12:09:36 [15922] [6] DEBUG:   source_addr: "0660....."
2017-09-26 12:09:36 [15922] [6] DEBUG:   dest_addr_ton: 1 =
0x00000001
2017-09-26 12:09:36 [15922] [6] DEBUG:   dest_addr_npi: 1 =
0x00000001
2017-09-26 12:09:36 [15922] [6] DEBUG:   destination_addr:
"43668....."
2017-09-26 12:09:36 [15922] [6] DEBUG:   esm_class: 0 = 0x00000000
2017-09-26 12:09:36 [15922] [6] DEBUG:   protocol_id: 0 =
0x00000000

```

```

2017-09-26 12:09:36 [15922] [6] DEBUG: priority_flag: 0 =
0x00000000
2017-09-26 12:09:36 [15922] [6] DEBUG: schedule_delivery_time:
NULL
2017-09-26 12:09:36 [15922] [6] DEBUG: validity_period: NULL
2017-09-26 12:09:36 [15922] [6] DEBUG: registered_delivery: 0 =
0x00000000
2017-09-26 12:09:36 [15922] [6] DEBUG: replace_if_present_flag: 0
= 0x00000000
2017-09-26 12:09:36 [15922] [6] DEBUG: data_coding: 3 =
0x00000003
2017-09-26 12:09:36 [15922] [6] DEBUG: sm_default_msg_id: 0 =
0x00000000
2017-09-26 12:09:36 [15922] [6] DEBUG: sm_length: 158 =
0x0000009e
2017-09-26 12:09:36 [15922] [6] DEBUG: short_message:
2017-09-26 12:09:36 [15922] [6] DEBUG: Octet string at
0x7f227400f80:
2017-09-26 12:09:36 [15922] [6] DEBUG: len: 158
2017-09-26 12:09:36 [15922] [6] DEBUG: size: 159
2017-09-26 12:09:36 [15922] [6] DEBUG: immutable: 0
2017-09-26 12:09:36 [15922] [6] DEBUG: data: 5a <14 bytes> 46
2017-09-26 12:09:36 [15922] [6] DEBUG: data: 72 <14 bytes> 68
2017-09-26 12:09:36 [15922] [6] DEBUG: data: 61 <14 bytes> 67
2017-09-26 12:09:36 [15922] [6] DEBUG: data: 20 <14 bytes> 57
2017-09-26 12:09:36 [15922] [6] DEBUG: data: 65 <14 bytes> 63
2017-09-26 12:09:36 [15922] [6] DEBUG: data: 68 <14 bytes> 73
2017-09-26 12:09:36 [15922] [6] DEBUG: data: 2e <14 bytes> 61
2017-09-26 12:09:36 [15922] [6] DEBUG: data: 6c <14 bytes> 73
2017-09-26 12:09:36 [15922] [6] DEBUG: data: 3a <14 bytes> 73
2017-09-26 12:09:36 [15922] [6] DEBUG: data: 4d <14 bytes> 6e
2017-09-26 12:09:36 [15922] [6] DEBUG: Octet string dump ends.
2017-09-26 12:09:36 [15922] [6] DEBUG: SMPP PDU dump ends.
2017-09-26 12:09:36 [15922] [6] DEBUG: SMPP[default_smsc]: Sending
PDU:
2017-09-26 12:09:36 [15922] [6] DEBUG: SMPP PDU 0x7f2274020790
dump:
2017-09-26 12:09:36 [15922] [6] DEBUG: type_name: deliver_sm_resp
2017-09-26 12:09:36 [15922] [6] DEBUG: command_id: 2147483653 =
0x80000005
2017-09-26 12:09:36 [15922] [6] DEBUG: command_status: 0 =
0x00000000
2017-09-26 12:09:36 [15922] [6] DEBUG: sequence_number: 11867393
= 0x00b51501
2017-09-26 12:09:36 [15922] [6] DEBUG: message_id: NULL
2017-09-26 12:09:36 [15922] [6] DEBUG: SMPP PDU dump ends.
2017-09-26 12:09:36 [15922] [6] DEBUG: SMPP[default_smsc]:
throughput (0.00,5.00)
...

```

Example sent message:

```

...
2017-09-26 12:04:08 [15922] [6] DEBUG: SMPP[default_smsc]:
throughput (0.00,5.00)
2017-09-26 12:04:08 [15922] [6] DEBUG: SMPP[default_smsc]: Manually
forced source addr ton = 1, source add npi = 1
2017-09-26 12:04:08 [15922] [6] DEBUG: SMPP[default_smsc]: Manually
forced dest addr ton = 1, dest add npi = 1
2017-09-26 12:04:08 [15922] [6] DEBUG: SMPP[default_smsc]: Sending
PDU:
2017-09-26 12:04:08 [15922] [6] DEBUG: SMPP PDU 0x7f2274025070
dump:
2017-09-26 12:04:08 [15922] [6] DEBUG: type_name: submit_sm
2017-09-26 12:04:08 [15922] [6] DEBUG: command_id: 4 = 0x00000004
2017-09-26 12:04:08 [15922] [6] DEBUG: command_status: 0 =
0x00000000
2017-09-26 12:04:08 [15922] [6] DEBUG: sequence_number: 98163 =
0x00017f73
2017-09-26 12:04:08 [15922] [6] DEBUG: service_type: NULL
2017-09-26 12:04:08 [15922] [6] DEBUG: source_addr_ton: 5 =
0x00000005
2017-09-26 12:04:08 [15922] [6] DEBUG: source_addr_npi: 0 =
0x00000000
2017-09-26 12:04:08 [15922] [6] DEBUG: source_addr: "any"
2017-09-26 12:04:08 [15922] [6] DEBUG: dest_addr_ton: 1 =
0x00000001
2017-09-26 12:04:08 [15922] [6] DEBUG: dest_addr_npi: 1 =
0x00000001
2017-09-26 12:04:08 [15922] [6] DEBUG: destination_addr:
"43676....."
2017-09-26 12:04:08 [15922] [6] DEBUG: esm_class: 3 = 0x00000003
2017-09-26 12:04:08 [15922] [6] DEBUG: protocol_id: 0 =
0x00000000
2017-09-26 12:04:08 [15922] [6] DEBUG: priority_flag: 0 =
0x00000000
2017-09-26 12:04:08 [15922] [6] DEBUG: schedule_delivery_time:
NULL
2017-09-26 12:04:08 [15922] [6] DEBUG: validity_period: NULL
2017-09-26 12:04:08 [15922] [6] DEBUG: registered_delivery: 0 =
0x00000000
2017-09-26 12:04:08 [15922] [6] DEBUG: replace_if_present_flag: 0
= 0x00000000
2017-09-26 12:04:08 [15922] [6] DEBUG: data_coding: 0 =
0x00000000
2017-09-26 12:04:08 [15922] [6] DEBUG: sm_default_msg_id: 0 =
0x00000000
2017-09-26 12:04:08 [15922] [6] DEBUG: sm_length: 23 = 0x00000017
2017-09-26 12:04:08 [15922] [6] DEBUG: short_message:
2017-09-26 12:04:08 [15922] [6] DEBUG: Octet string at
0x7f227400c460:
2017-09-26 12:04:08 [15922] [6] DEBUG: len: 23
2017-09-26 12:04:08 [15922] [6] DEBUG: size: 24

```

```

2017-09-26 12:04:08 [15922] [6] DEBUG:      immutable: 0
2017-09-26 12:04:08 [15922] [6] DEBUG:      data: 44 <14 bytes> 73
2017-09-26 12:04:08 [15922] [6] DEBUG:      data: 74 <5 bytes> 39
2017-09-26 12:04:08 [15922] [6] DEBUG:      Octet string dump ends.
2017-09-26 12:04:08 [15922] [6] DEBUG: SMPP PDU dump ends.
2017-09-26 12:04:08 [15922] [6] DEBUG: SMPP[default_smsc]:
throughput (1.00,5.00)
...

```

Example link enquiry:

```

...
2017-09-26 12:13:38 [15922] [6] DEBUG: SMPP[default_smsc]:
throughput (0.00,5.00)
2017-09-26 12:13:38 [15922] [6] DEBUG: SMPP[default_smsc]: Got PDU:
2017-09-26 12:13:38 [15922] [6] DEBUG: SMPP PDU 0x7f2274020790
dump:
2017-09-26 12:13:38 [15922] [6] DEBUG:      type_name: enquire_link
2017-09-26 12:13:38 [15922] [6] DEBUG:      command_id: 21 =
0x00000015
2017-09-26 12:13:38 [15922] [6] DEBUG:      command_status: 0 =
0x00000000
2017-09-26 12:13:38 [15922] [6] DEBUG:      sequence_number: 90764 =
0x0001628c
2017-09-26 12:13:38 [15922] [6] DEBUG: SMPP PDU dump ends.
2017-09-26 12:13:38 [15922] [6] DEBUG: SMPP[default_smsc]: Sending
PDU:
2017-09-26 12:13:38 [15922] [6] DEBUG: SMPP PDU 0x7f2274025070
dump:
2017-09-26 12:13:38 [15922] [6] DEBUG:      type_name:
enquire_link_resp
2017-09-26 12:13:38 [15922] [6] DEBUG:      command_id: 2147483669 =
0x80000015
2017-09-26 12:13:38 [15922] [6] DEBUG:      command_status: 0 =
0x00000000
2017-09-26 12:13:38 [15922] [6] DEBUG:      sequence_number: 90764 =
0x0001628c
2017-09-26 12:13:38 [15922] [6] DEBUG: SMPP PDU dump ends.
2017-09-26 12:13:38 [15922] [6] DEBUG: SMPP[default_smsc]:
throughput (0.00,5.00)
...

```

### SMS Box (PRX node of NGCP)

On the PRX node you can see a **process** named "**smsbox**". This process has a **listening port** assigned to it: 13002, that is the communication port towards the *Bearer Box* component running on LB nodes.

The *ngcp-service* tool also shows the *smsbox* process in its summary information:

```

$ ngcp-service summary
Ok Service                               Managed   Started   Status
-- -----
...
kannel-smsbox                            managed   by-ha     active
...

```

The following log files can provide information about the operation of *SMS Box*:

- sent and received messages using the API of WEB node: /var/log/kannel/smsbox.log

**NOTE**

Sent and received message examples shown here do not contain the full phone number and content for confidentiality reason.

Example sent message:

```

...
2017-09-26 12:16:42 [22763] [2] DEBUG: HTTP: Creating HTTPClient
for `192.168.1.2'.
2017-09-26 12:16:42 [22763] [2] DEBUG: HTTP: Created HTTPClient
area 0x7f5dcc000ad0.
2017-09-26 12:16:42 [22763] [3] INFO: smsbox: Got HTTP request
</cgi-bin/sendsms> from <192.168.1.3>
2017-09-26 12:16:42 [22763] [3] INFO: sendsms used by <sipwise>
2017-09-26 12:16:42 [22763] [3] INFO: sendsms
sender:<sipwise:43668.....> (192.168.1.3) to:<43676.....>
msg:<...>
2017-09-26 12:16:42 [22763] [3] DEBUG: Stored UUID ab95eb45-1ec0-
4932-9863-1a95609a025f
2017-09-26 12:16:42 [22763] [3] DEBUG: message length 52, sending 1
messages
2017-09-26 12:16:42 [22763] [3] DEBUG: Status: 202 Answer: <Sent.>
2017-09-26 12:16:42 [22763] [3] DEBUG: Delayed reply - wait for
bearerbox
2017-09-26 12:16:42 [22763] [0] DEBUG: Got ACK (0) of ab95eb45-
1ec0-4932-9863-1a95609a025f
2017-09-26 12:16:42 [22763] [0] DEBUG: HTTP: Destroying HTTPClient
area 0x7f5dcc000ad0.
2017-09-26 12:16:42 [22763] [0] DEBUG: HTTP: Destroying HTTPClient
for `192.168.1.3'.
...

```

Example received message:

```

...
2017-09-26 11:59:45 [22763] [5] INFO: Starting to service
<...message content...> from <+43676-----> to <+43668----->
2017-09-26 11:59:45 [22763] [10] DEBUG: Queue contains 0 pending
requests.

```

```

2017-09-26 11:59:45 [22763] [10] DEBUG: HTTPS URL; Using SSL for
the connection
2017-09-26 11:59:45 [22763] [10] DEBUG: Parsing URL
`https://192.168.1.2:1443/internalsms/receive?auth_token=fNLosMgwdN
UrKvEfFm9
&timestamp=2017-09-26+09:59:45&from=%2B43676-----
&to=%2B43668-----&charset=UTF-8&coding=0&text=...':
2017-09-26 11:59:45 [22763] [10] DEBUG:   Scheme: https://
2017-09-26 11:59:45 [22763] [10] DEBUG:   Host: 192.168.1.2
2017-09-26 11:59:45 [22763] [10] DEBUG:   Port: 1443
2017-09-26 11:59:45 [22763] [10] DEBUG:   Username: (null)
2017-09-26 11:59:45 [22763] [10] DEBUG:   Password: (null)
2017-09-26 11:59:45 [22763] [10] DEBUG:   Path:
/internalsms/receive
2017-09-26 11:59:45 [22763] [10] DEBUG:   Query:
auth_token=fNLosMgwdNUrKvEfFm9&timestamp=2017-09-
26+09:59:45&from=%2B43676-----
&to=%2B43668-----&charset=UTF-8&coding=0&text=...
2017-09-26 11:59:45 [22763] [10] DEBUG:   Fragment: (null)
2017-09-26 11:59:45 [22763] [10] DEBUG: Connecting nonblocking to
<192.168.1.2>
2017-09-26 11:59:45 [22763] [10] DEBUG: HTTP: Opening connection to
`192.168.1.2:1443' (fd=31).
2017-09-26 11:59:45 [22763] [10] DEBUG: Socket connecting
2017-09-26 11:59:45 [22763] [9] DEBUG: Get info about connecting
socket
2017-09-26 11:59:45 [22763] [9] DEBUG: HTTP: Sending request:
2017-09-26 11:59:45 [22763] [9] DEBUG: Octet string at
0x7f5dbc00f470:
2017-09-26 11:59:45 [22763] [9] DEBUG:   len: 382
2017-09-26 11:59:45 [22763] [9] DEBUG:   size: 1024
2017-09-26 11:59:45 [22763] [9] DEBUG:   immutable: 0
2017-09-26 11:59:45 [22763] [9] DEBUG:   data: 47 45 54 20 2f 69 6e
74 65 72 6e 61 6c 73 6d 73   GET /internalsms
2017-09-26 11:59:45 [22763] [9] DEBUG:   data: 2f 72 65 63 65 69 76
65 3f 61 75 74 68 5f 74 6f   /receive?auth_to
2017-09-26 11:59:45 [22763] [9] DEBUG:   data: 6b 65 6e 3d ...
ken=
                                                                    ... 20 48
54 54 50 2f 31 2e 31 0d 0a   HTTP/1.1..
2017-09-26 11:59:45 [22763] [9] DEBUG:   data: 43 6f 6e 6e 65 63 74
69 6f 6e 3a 20 6b 65 65 70   Connection: keep
2017-09-26 11:59:45 [22763] [9] DEBUG:   data: 2d 61 6c 69 76 65 0d
0a 55 73 65 72 2d 41 67 65   -alive..User-Age
2017-09-26 11:59:45 [22763] [9] DEBUG:   data: 6e 74 3a 20 4b 61 6e
6e 65 6c 2f 31 2e 34 2e 34   nt: Kannel/1.4.4
2017-09-26 11:59:45 [22763] [9] DEBUG:   data: 0d 0a 48 6f 73 74 3a
20 31 39 32 2e 31 36 38 2e   ..Host: 192.168.
2017-09-26 11:59:45 [22763] [9] DEBUG:   data: 31 2e 32 3a 31 34 34
33 0d 0a 0d 0a   1.2:1443....
2017-09-26 11:59:45 [22763] [9] DEBUG: Octet string dump ends.
2017-09-26 11:59:45 [22763] [9] DEBUG: HTTP: Status line: <HTTP/1.1

```

```

200 OK>
2017-09-26 11:59:45 [22763] [9] DEBUG: HTTP: Received response:
2017-09-26 11:59:45 [22763] [9] DEBUG: Octet string at
0x7f5dbc006970:
2017-09-26 11:59:45 [22763] [9] DEBUG:   len:   333
2017-09-26 11:59:45 [22763] [9] DEBUG:   size: 1024
2017-09-26 11:59:45 [22763] [9] DEBUG:   immutable: 0
2017-09-26 11:59:45 [22763] [9] DEBUG:   data: 53 65 72 76 65 72 3a
20 6e 67 69 6e 78 0d 0a 44   Server: nginx..D
2017-09-26 11:59:45 [22763] [9] DEBUG:   data: 61 74 65 3a 20 54 75
65 2c 20 32 36 20 53 65 70   ate: Tue, 26 Sep
2017-09-26 11:59:45 [22763] [9] DEBUG:   data: 20 32 30 31 37 20 30
39 3a 35 39 3a 34 35 20 47   2017 09:59:45 G
2017-09-26 11:59:45 [22763] [9] DEBUG:   data: 4d 54 0d 0a 43 6f 6e
74 65 6e 74 2d 54 79 70 65   MT..Content-Type
2017-09-26 11:59:45 [22763] [9] DEBUG:   data: 3a 20 74 65 78 74 2f
68 74 6d 6c 3b 20 63 68 61   : text/html; cha
2017-09-26 11:59:45 [22763] [9] DEBUG:   data: 72 73 65 74 3d 75 74
66 2d 38 0d 0a 43 6f 6e 74   rset=utf-8..Cont
2017-09-26 11:59:45 [22763] [9] DEBUG:   data: 65 6e 74 2d 4c 65 6e
67 74 68 3a 20 30 0d 0a 43   ent-Length: 0..C
2017-09-26 11:59:45 [22763] [9] DEBUG:   data: 6f 6e 6e 65 63 74 69
6f 6e 3a 20 6b 65 65 70 2d   onnection: keep-
2017-09-26 11:59:45 [22763] [9] DEBUG:   data: 61 6c 69 76 65 0d 0a
53 65 74 2d 43 6f 6f 6b 69   alive..Set-Cooki
2017-09-26 11:59:45 [22763] [9] DEBUG:   data: 65 3a 20 6e 67 63 70
5f 70 61 6e 65 6c 5f 73 65   e: ngcp_panel_se
2017-09-26 11:59:45 [22763] [9] DEBUG:   data: 73 73 69 6f 6e 3d 34
35 30 32 64 64 66 65 31 62   ssion=4502ddfe1b
2017-09-26 11:59:45 [22763] [9] DEBUG:   data: 63 31 65 33 39 30 65
30 64 36 66 39 64 34 37 30   cle390e0d6f9d470
2017-09-26 11:59:45 [22763] [9] DEBUG:   data: 35 30 37 62 64 64 33
61 65 32 36 62 64 63 3b 20   507bdd3ae26bdc;
2017-09-26 11:59:45 [22763] [9] DEBUG:   data: 70 61 74 68 3d 2f 3b
20 65 78 70 69 72 65 73 3d   path=/; expires=
2017-09-26 11:59:45 [22763] [9] DEBUG:   data: 54 75 65 2c 20 32 36
2d 53 65 70 2d 32 30 31 37   Tue, 26-Sep-2017
2017-09-26 11:59:45 [22763] [9] DEBUG:   data: 20 31 30 3a 35 39 3a
34 35 20 47 4d 54 3b 20 48   10:59:45 GMT; H
2017-09-26 11:59:45 [22763] [9] DEBUG:   data: 74 74 70 4f 6e 6c 79
0d 0a 58 2d 43 61 74 61 6c   ttpOnly..X-Catal
2017-09-26 11:59:45 [22763] [9] DEBUG:   data: 79 73 74 3a 20 35 2e
39 30 30 37 35 0d 0a 53 74   yst: 5.90075..St
2017-09-26 11:59:45 [22763] [9] DEBUG:   data: 72 69 63 74 2d 54 72
61 6e 73 70 6f 72 74 2d 53   rict-Transport-S
2017-09-26 11:59:45 [22763] [9] DEBUG:   data: 65 63 75 72 69 74 79
3a 20 6d 61 78 2d 61 67 65   ecurity: max-age
2017-09-26 11:59:45 [22763] [9] DEBUG:   data: 3d 31 35 37 36 38 30
30 30 0d 0a 0d 0a           =15768000....
2017-09-26 11:59:45 [22763] [9] DEBUG: Octet string dump ends.
2017-09-26 11:59:45 [22763] [6] WARNING: Tried to set Coding field,
denied.

```

```
2017-09-26 11:59:45 [22763] [6] INFO: No reply sent, denied.
2017-09-26 11:59:55 [22763] [9] DEBUG: HTTP: Server closed
connection, destroying it
<192.168.1.2:1443:1::><0x7f5db0000b20><fd:31>.
...
```

- short log of sent/received messages: /var/log/kannel/smsbox-access.log

```
...
2017-09-26 12:39:18 SMS HTTP-request sender:+43680----- request: ''
url: 'https://192.168.1.2:1443/internalsms/receive?
auth_token=fNLosMgwdNURKvEfm9&timestamp=2017-09-
26+10:39:18&from=%2B43680-----&to=%2B43668-----&charset=UTF-
8&coding=0
&text=<...message content...>' reply: 200 '<< successful >>'
...
2017-09-26 12:41:54 send-SMS request added -
sender:sipwise:43668----- 192.168.1.3 target:43680----- request:
'<...message content...>'
...
```

### 8.6.3. REST API

Handling of short messages from the user perspective happens with the help of NGCP's REST API. There is a dedicated resource: <https://<IP of WEB node>:1443/api/sms> that allows you to:

- Get a **list of sent and received messages**. This is achieved by sending a GET request on the /api/sms collection, as in the following example:

```
curl -i -X GET -H 'Connection: close' --cert NGCP-API-client-
certificate.pem \
  --cacert ca-cert.pem
'https://example.org:1443/api/sms/?page=1&rows=10'
```

- **Retrieve an SM** (both sent and received). This is achieved by sending a GET request for a specific /api/sms/id item, as in the following example:

```
curl -i -X GET -H 'Connection: close' --cert NGCP-API-client-
certificate.pem \
  --cacert ca-cert.pem 'https://example.org:1443/api/sms/1'
```

- **Send a new message** from a local subscriber. This is achieved by sending a POST request for the /api/sms collection, as in the following example:

```
curl -i -X POST -H 'Connection: close' -H 'Content-Type:
application/json' \
  --cert NGCP-API-client-certificate.pem --cacert ca-cert.pem \
```

```
'https://example.org:1443/api/sms/' --data-binary '{"callee" :  
"43555666777", \  
"subscriber_id" : 4, "text" : "test"}'
```

As always, the full documentation of the REST API resources is available on the admin web interface of NGCP: <https://<IP of WEB node>:1443/api/#sms>

# Chapter 9. Configuration Framework

The Sipwise C5 provides a configuration framework for consistent and easy to use low level settings management. A basic usage of the configuration framework only needs two actions already used in previous chapters:

- Edit `/etc/ngcp-config/config.yml` file.
- Execute `ngcpcfg apply 'my commit message'` command.

Low level management of the configuration framework might be required by advanced users though. This chapter explains the architecture and usage of Sipwise C5 configuration framework. If the basic usage explained above fits your needs, feel free to skip this chapter and return to it when your requirements change.

A more detailed workflow of the configuration framework for creating a configuration file consists of 8 steps:

- Generation or editing of configuration templates and/or configuration values.
- Generation of the configuration files based on configuration templates and configuration values defined in `config.yml`, `constants.yml` and `network.yml` files.
- Execution of *prebuild* commands if defined for a particular configuration file or configuration directory.
- Placement of the generated configuration file in the target directory. This step is called *build* in the configuration framework.
- Execution of *postbuild* commands if defined for that configuration file or configuration directory.
- Execution of post-build actions after the build process, such as synchronizing the database credentials, grants and timezones. This step is called *post-build* in the configuration framework.
- Execution of *services* commands if defined for that configuration file or configuration directory. This step is called *services* in the configuration framework.
- Saving of the generated changes. This step is called *commit* in the configuration framework.

## 9.1. Configuration templates

The Sipwise C5 provides configuration file templates for most of the services it runs. These templates are stored in the directory `/etc/ngcp-config/templates`.

Example: Template files for `/etc/kamailio/proxy/kamailio.cfg` are stored in `/etc/ngcp-config/templates/etc/kamailio/proxy/`.

There are different types of files in this template framework, which are described below.

### 9.1.1. `.tt2`, `.customtt.tt2` and `.patchtt.tt2` files

These files are the main template files that will be used to generate the final configuration file for the running service. They contain all the configuration options needed for a running Sipwise C5 system. The configuration framework will combine these files with the values provided by `config.yml`, `constants.yml` and `network.yml` to generate the appropriate configuration file.

Example: Let's say we are changing the IP used by kamailio load balancer on interface *eth0* to IP 203.0.113.42. This will change kamailio's listen IP address, when the configuration file is generated. A quick look to the template file under */etc/ngcp-config/templates/etc/kamailio/lb/kamailio.cfg.tt2* will show a line like this:

```
listen=udp:[% ip %]:[% kamailio.lb.port %]
```

After applying the changes with the *ngcpcfg apply 'my commit message'* command, a new configuration file will be created under */etc/kamailio/lb/kamailio.cfg* with the proper values taken from the main configuration files (in this case *network.yml*):

```
listen=udp:203.0.113.42:5060
```

All the low-level configuration is provided by these .tt2 template files and the corresponding config.yml file. Anyway, advanced users might require a more particular configuration.

Instead of editing .tt2 files, the configuration framework recognises .customtt.tt2 files. These files are the same as .tt2, but they have higher priority when the configuration framework creates the final configuration files. If you need to introduce changes in a template, you must always copy the required .tt2 file to .customtt.tt2, make changes in the latter file one and leave the .tt2 file untouched. This way, the system will use the new custom configuration allowing you to switch back to the original one quickly.

Example: We'll create */etc/ngcp-config/templates/etc/lb/kamailio.cfg.customtt.tt2* and use it for our customized configuration. In this example, we'll append a comment at the end of the template.

```
cd /etc/ngcp-config/templates/etc/kamailio/lb
cp kamailio.cfg.tt2 kamailio.cfg.customtt.tt2
echo '# This is my last line comment' >> kamailio.cfg.customtt.tt2
ngcpcfg apply 'my commit message'
```

The *ngcpcfg* command will generate */etc/kamailio/lb/kamailio.cfg* from our custom template instead of the general one:

```
tail -1 /etc/kamailio/lb/kamailio.cfg
# This is my last line comment
```

### WARNING

users have to upgrade all .customtt.tt2 manually every time .tt2 is upgraded, as *ngcpcfg* completely ignores new code in .tt2 received from new package version.

The huge drawback of .customtt.tt2 files are necessity to keep them up-to-date manually. Keeping them outdated will cause the system misbehaviour as different components will use different code version (as new .tt2 version will be overwritten by old .customtt.tt2).

The .patchtt.tt2 concept should help users here. It will minimise the manual efforts by using the "patch(1)" utility. The *ngcpcfg* tool is searching for .patchtt.tt2 files every time '*ngcpcfg build*' has been called. If .patchtt.tt2 is detected, the *ngcpcfg* tool will try to apply .patchtt.tt2 on .tt2 and store result in

.customtt.tt2 if no conflicts noticed during patching. Further building process happens in a common way. Example:

```
root@spce:~# ngcpcfg build /etc/kamailio/lb/kamailio.cfg
spce: yml configs were validated successfully
spce: configs were checked successfully
spce: Validating patch '/etc/ngcp-
config/templates/etc/kamailio/lb/kamailio.cfg.patchtt.tt2'
spce: Applying patch '/etc/ngcp-
config/templates/etc/kamailio/lb/kamailio.cfg.patchtt.tt2'
spce: Successfully created '/etc/ngcp-
config/templates/etc/kamailio/lb/kamailio.cfg.customtt.tt2'
spce: Requested patchtt operation has finished successfully.
Loading /etc/ngcp-config/config.yml in memory: OK
Loading /etc/ngcp-config/network.yml in memory: OK
Loading /etc/ngcp-config/constants.yml in memory: OK
spce: Generating /etc/kamailio/lb/kamailio.cfg: OK
spce: Executing postbuild for /etc/kamailio/lb/kamailio.cfg
root@spce:~#
```

To convert some/all the current .customtt.tt2 users can use command `ngcpcfg patch --from-customtt <customtt_file>`:

```
root@spce:~# ngcpcfg patch --from-customtt /etc/ngcp-
config/templates/etc/kamailio/lb/kamailio.cfg.customtt.tt2
spce: Validating customtt '/etc/ngcp-
config/templates/etc/kamailio/lb/kamailio.cfg.customtt.tt2'
spce: Creating patchtt file '/etc/ngcp-
config/templates/etc/kamailio/lb/kamailio.cfg.patchtt.tt2'
spce: Requested customtt operation has finished successfully.
root@spce:~#
```

Here is the example of newly created .patchtt.tt2 file:

```
root@spce:~# cat /etc/ngcp-
config/templates/etc/kamailio/lb/kamailio.cfg.patchtt.tt2
@@ -1799,3 +1799,4 @@
}

# vim: ft=cfg
+# This is my last line comment
root@spce:~#
```

See more details about .patchtt.tt2 files below in [patchtt section](#).

#### TIP

The .tt2 files use the [Template Toolkit](#) language. Therefore you can use all the feature this excellent toolkit provides within ngcpcfg's template files (all the ones with the .tt2 suffix).

### 9.1.2. Using patchtt for generation of a relevant customtt file

Keeping custom modifications directly in the `.customtt.tt2` templates is NOT recommended as templates become outdated with every software upgrade.

A better way is to handle custom modifications using `.patchtt.tt2` files (e.g. `/etc/ngcp-config/templates/etc/cron.d/cleanup-tools.patchtt.tt2`). In this case, on every "ngcpcfg patch", a `.patchtt.tt2` file will be applied on top of the `.tt2` file and the result will be saved into the `customtt` file and used commonly as described in the previous section. "ngcpcfg patch" is the first step on "ngcpcfg build" that guarantees the latest upstream templates with the availability of the necessary local changes on every configuration apply.

**TIP**

The patch to be applied to the corresponding `.tt2` template file is selected in the following order (highest to lowest): `*.patchtt.tt2.$HOSTNAME` `*.patchtt.tt2.$PAIRNAME` `*.patchtt.tt2.$SHA_NODE` `*.patchtt.tt2`

**NOTE**

If a suitable `patchtt` file is found for a template, then the `ngcpcfg patch` command will overwrite the corresponding `customtt` file, if any.

#### Creating a patchtt file

Let us see how to introduce custom changes into a template through a `patchtt` file. For example, we need to change the accounting records cleanup time, which is defined in `cleanup-tools.tt2`. Here is how to do this:

- Go to the corresponding templates directory:

```
cd /etc/ngcp-config/templates/etc/cron.d/
```

- Duplicate the required `.tt2` file to `.customtt.tt2`

```
cp ./cleanup-tools.tt2 ./cleanup-tools.customtt.tt2
```

- Introduce the necessary changes to the duplicated file:

```
vim ./cleanup-tools.customtt.tt2
```

- Create the `patchtt` file from your `customtt` file and recheck it:

```
ngcpcfg patch --from-customtt ./cleanup-tools.customtt.tt2  
cat ./cleanup-tools.patchtt.tt2
```

- Apply and push the changes

```
ngcpcfg apply "Change acc-cleanup time from 00 to 02 hours"  
ngcpcfg push all
```

You will notice that the "ngcpcfg apply" command has generated the customtt file for the corresponding template:

```
root@web01a:/etc/ngcp-config/templates/etc/cron.d# ls -l ./cleanup-
tools*
-rw----- 1 root root 932 Jan  4 11:11 ./cleanup-tools.customtt.tt2
-rw-r--r-- 1 root root 630 Jan  4 11:08 ./cleanup-tools.patchtt.tt2
-rw-r--r-- 1 root root 932 Dec 18 15:09 ./cleanup-tools.tt2
```

Now, even if cleanup-tools.tt2 slightly changes after a software upgrade, "ngcpcfg apply" will still preserve your custom changes.

#### NOTE

If in a new release the .tt2 file gets changed in the same lines where you had introduced custom changes (e.g. your changes were temporary until a feature is implemented properly in a new software release), the apply process will fail and ask you to review the corresponding .patchtt.tt2 file. Then, check it and either correct if it is still required or remove it.

#### TIP

To convert all existing customtt files to patchtt files use the command: **ngcpcfg patch --from-customtt**

### 9.1.3. .prebuild and .postbuild files

After creating the configuration files, the configuration framework can execute some commands before and after placing that file in its target directory. These commands usually are used for changing the file's owner, groups, or any other attributes. There are some rules these commands need to match:

- They have to be placed in a *.prebuild* or *.postbuild* file in the same path as the original *.tt2* file.
- The file name must be the same as the configuration file, but having the mentioned suffixes.
- The commands must be *bash* compatible.
- The commands must return 0 if successful.
- The target configuration file is matched by the environment variable *output\_file*.

Example: We need *www-data* as owner of the configuration file */etc/ngcp-ossbss/provisioning.conf*. The configuration framework will by default create the configuration files with *root:root* as owner:group and with the same permissions (*rwX*) as the original template. For this particular example, we will change the owner of the generated file using the *.postbuild* mechanism.

```
echo 'chgrp www-data ${output_file}' \  
> /etc/ngcp-config/templates/etc/ngcp-ossbss/provisioning.conf.postbuild
```

### 9.1.4. .services files

*.services* files are pretty similar and might contain commands that will be executed after the *build* process. There are two types of *.services* files:

- The particular one, with the same name as the configuration file it is associated to.

Example: `/etc/ngcp-config/templates/etc/asterisk/sip.conf.services` is associated to `/etc/asterisk/sip.conf`

- The general one, named `ngcpcfg.services` that is associated to every file in its target directory.  
Example: `/etc/ngcp-config/templates/etc/asterisk/ngcpcfg.services` is associated to every file under `/etc/asterisk/`

When the `services` step is triggered all `.services` files associated to a changed configuration file will be executed. In case of the general file, any change to any of the configuration files in the directory will trigger the execution of the commands.

**TIP**

If the service script has the execute flags set (`chmod +x $file`) it will be invoked directly. If it doesn't have execute flags set it will be invoked under `bash`. Make sure the script is `bash` compatible if you do not set execute permissions on the service file.

These commands are usually service reload/restarts to ensure the new configuration has been loaded by running services.

**NOTE**

The configuration files mentioned in the following example usually already exist on the platform. Please make sure you don't overwrite any existing files if following this example.

Example:

```
echo 'ngcp-service restart mariadb' \  
> /etc/ngcpcfg-config/templates/etc/mysql/my.cnf.services  
echo 'ngcp-service restart asterisk' \  
> /etc/ngcpcfg-config/templates/etc/asterisk/ngcpcfg.services
```

In this example we created two `.services` files. Now, each time we trigger a change to `/etc/mysql/my.cnf` or to `/etc/asterisk/*` we'll see that MySQL or Asterisk services will be restarted by the `ngcpcfg` system.

## 9.2. config.yml, constants.yml and network.yml files

The `/etc/ngcp-config/config.yml` file contains all the user-configurable options, using the [YAML](#) (YAML Ain't Markup Language) syntax.

The `/etc/ngcp-config/constants.yml` file provides configuration options for the platform that aren't supposed to be edited by the user. Do not manually edit this file unless you really know what you're doing.

The `/etc/ngcp-config/network.yml` file provides configuration options for all interfaces and IP addresses on those interfaces. You can use the `ngcp-network` tool for conveniently change settings without having to manually edit this file.

The `/etc/ngcp-ngcpcfg/ngcpcfg.cfg` file is the main configuration file for `ngcpcfg` itself. Do not manually edit this file unless you really know what you are doing.

## 9.3. ngcpcfg and its command line options

On a CARRIER the shared storage used by all nodes is the shared storage of the mgmt pair.

The `ngcpcfg` utility supports the following command line options:

### 9.3.1. apply

The `apply` option is a short-cut for the options "check && build && post-build && services && commit" and also executes `etckeeper` to record any modified files inside `/etc`. It is the recommended option to use the `ngcpcfg` framework unless you want to execute any specific commands as documented below.

### 9.3.2. build

The `build` option generates (and therefore also updates) configuration files based on their configuration (`config.yml`) and template files (`.tt2`). Before the configuration file is generated a present `.prebuild` will be executed, after generation of the configuration file the according `.postbuild` script (if present) will be executed. If a *file* or *directory* is specified as argument the build will generate only the specified configuration file/directory instead of running through all present templates.

Example: to generate only the file `/etc/nginx/sites-available/ngcp-panel` you can execute:

```
ngcpcfg build /etc/nginx/sites-available/ngcp-panel
```

Example: to generate all the files located inside the directory `/etc/nginx/` you can execute:

```
ngcpcfg build /etc/nginx/
```

### 9.3.3. cat

The `cat` option concatenates the YAML configuration files, including any local override files and prints them to standard output.

### 9.3.4. check

Check the syntax of the YAML files and validate them against schemas.

### 9.3.5. clean

Clean `/etc/ngcp-config/` from uncommitted or unapplied changes, reset the git state and remove any possibly existing git stashed changes. It will also proposed to delete unnecessary git branches.

### 9.3.6. commit

The `commit` option records any changes done to the configuration tree inside `/etc/ngcp-config`. The commit option should be executed when you've modified anything inside the configuration tree.

### 9.3.7. decrypt

Decrypt `/etc/ngcp-config.tgz.gpg` (or `/etc/ngcp-config-encrypted.tgz.gpg` for backwards compatibility) and restore configuration files, doing the reverse operation of the `encrypt` option. Note: This feature is only available if the `ngcp-ngcpcfg-locker` package is installed.

### 9.3.8. del

Deletes a specified key from a specified YAML configuration file.

### 9.3.9. diff

Show uncommitted changes between ngcpcfg's Git repository and the working tree inside */etc/ngcp-config*. If the tool doesn't report anything it means that there are no uncommitted changes. If the *--addremove* option is specified then new and removed files (iff present) that are not yet (un)registered to the repository will be reported, no further diff actions will be executed then. Note: This option is available since ngcp-ngcpcfg version 0.11.0.

### 9.3.10. edit

Convenience option to edit the YAML files.

### 9.3.11. encrypt

Encrypt */etc/ngcp-config* and all resulting configuration files with a user defined password and save the result as */etc/ngcp-config.tgz.pgp*. Note: This feature is only available if the *ngcp-ngcpcfg-locker* package is installed.

### 9.3.12. get

Prints a value for a specified key from the YAML files.

### 9.3.13. help

The *help* options displays ngcpcfg's help screen and then exits without any further actions.

### 9.3.14. initialise

The *initialise* option sets up the ngcpcfg framework. This option is automatically executed by the installer for you, so you shouldn't have to use this option in normal operations mode.

### 9.3.15. log

Prints the log for local changes.

### 9.3.16. patch

Generate customtt files using default templates and patchtt files.

### 9.3.17. post-build

Performs needed actions after building the files, and before starting the services, such as synchronizing the database credentials, grants and timezones.

### 9.3.18. pull

Retrieve modifications from shared storage.

### 9.3.19. push

Push modifications to shared storage and remote systems. After changes have been pushed to the nodes the *build* option will be executed on each remote system to rebuild the configuration files (unless the *--nobuild* has been specified, then the build step will be skipped). If hostname(s) or IP address(es) is given as argument then the changes will be pushed to the shared storage and to the given hosts only. You can use 'all' as a shortcut to push to the other nodes. If no host has been specified then the hosts for this pair specified in */etc/ngcp-config/network.yml* are used.

### 9.3.20. push-parallel

Like the action *push* but performed in parallel.

### 9.3.21. services

The *services* option executes the service handlers for any modified configuration file(s)/directory.

### 9.3.22. set

Set a specified key to a value in a specified YAML configuration file.

### 9.3.23. show

Display the details for a specified 'change-id', or display the latest changes if no 'change-id' is specified.

### 9.3.24. status

The *status* option provides a human readable interface to check the state of the configuration tree. If you are unsure what should be done as next step or if want to check the current state of the configuration tree, invoke *ngcpcfg status*.

If everything is OK and nothing needs to be done the output should look like:

```
# ngcpcfg status
Checking state of ngcpcfg:
OK:  has been initialised already (without shared storage)
Checking state of configuration files:
OK:  nothing to commit.
Checking state of /etc files
OK:  nothing to commit.
```

If the output doesn't say "OK", follow the instructions provided by the output of 'ngcpcfg status'.

**NOTE**

Further details regarding the ngcpcfg tool are available through 'man ngcpcfg' on the Sipwise C5.

# Chapter 10. Network Configuration

Starting with version 2.7, Sipwise C5 uses a dedicated *network.yml* file to configure the IP addresses of the system. The reason for this is to be able to access all IPs of all nodes for all services from any particular node in case of a distributed system on one hand, and in order to be able to generate */etc/network/interfaces* automatically for all nodes based on this central configuration file.

## 10.1. General Structure

The basic structure of the file looks like this:

```
hosts:
  self:
    role:
      - proxy
      - lb
      - mgmt
    interfaces:
      - eth0
      - lo
    eth0:
      ip: 192.168.51.213
      netmask: 255.255.255.0
      type:
        - sip_ext
        - rtp_ext
        - web_ext
        - web_int
    lo:
      ip: 127.0.0.1
      netmask: 255.255.255.0
      type:
        - sip_int
        - ha_int
```

Some more complete, sample configuration is shown in [network.yml Overview](#) section of the handbook.

The file contains all configuration parameters under the main key: hosts

In Sipwise C5 systems all hosts of the system are defined, and the names are the actual host names instead of *self*, like this:

On a PRO it would look like:

```
hosts:
  sp1:
    peer: sp2
```

```

role: ...
interfaces: ...

sp2:
peer: sp1
role: ...
interfaces: ...

```

On a CARRIER it would look like:

```

hosts:

web01a:
peer: web01b
role: ...
interfaces: ...

web01b:
peer: web01a
role: ...
interfaces: ...

```

### 10.1.1. Available Host Options

There are three different main sections for a host in the config file, which are *role*, *interfaces* and the actual interface definitions.

- *role*: The role setting is an array defining which logical roles a node will act as. Possible entries for this setting are:

*mgmt*: This entry means the host is acting as management node for the platform. In a Sipwise C5 system this option must always be set. The management node exposes the admin and CSC panels to the users and the APIs to external applications and is used to export CDRs. Please note: on a CARRIER this is only set on the nodes of the management pairs. This node is also the source of the installations of other nodes via iPXE and has the *approx* service (apt proxy).

*lb*: This entry means the host is acting as SIP load-balancer for the platform. In a Sipwise C5 system this option must always be set. Please note: on a CARRIER this is only set on the nodes of the *lb* pairs. The SIP load-balancer acts as an ingress and egress point for all SIP traffic to and from the platform.

*proxy*: This entry means the host is acting as SIP proxy for the platform. In a Sipwise C5 system this option must always be set. Please note: on a CARRIER this is only set on the nodes of the *proxy* pairs. The SIP proxy acts as registrar, proxy and application server and media relay, and is responsible for providing the features for all subscribers provisioned on it.

*db*: This entry means the host is acting as the database node for the platform. In a Sipwise C5 system this option must always be set. Please note: on a CARRIER this is only set on the nodes of the *db* pairs. The database node exposes the MySQL and Redis databases.

*rtp*: This entry means the host is acting as the RTP relay node for the platform. In a Sipwise C5 system this option must always be set. Please note: on a CARRIER this is only set on the nodes of the *RTP relay* pairs. The RTP relay node runs the *rtpengine* Sipwise C5 component.

*li*: (CARRIER-only) This entry means the host is acting as the interface towards a lawful interception service provider. Note that the virtual *li\_dist* role cannot be specified in the configuration file as it is synthesized at run-time.

- *interfaces*: The interfaces setting is an array defining all interface names in the system. The actual interface details are set in the actual interface settings below. It typically includes lo, eth0, eth1 physical and a number of virtual interfaces, like: bond0, vlanXXX
- *<interface name>*: After the interfaces are defined in the *interfaces* setting, each of those interfaces needs to be specified as a separate set of parameters.

Additional main parameters of a node:

- *dbnode*: the sequence number (unique ID) of the node in the database cluster;
- *peer*: the hostname of the peer node within the pair of nodes (e.g. "sp2" for *sp1* host on a PRO; "web01b" for *web01a* host on a CARRIER). The purpose of that: each node knows its companion for providing high availability, data replication etc.
- *status*: one of 'online', 'offline', 'inactive'. 'inactive' means that the node is up but is not ready to work in the cluster (installing process). 'offline' means that the node is not reachable. 'online' is a normal working node.

### 10.1.2. Interface Parameters

- *hwaddr*: MAC address of the interface

#### CAUTION

On a CARRIER this *must* be filled in properly for the interface that is used as type *ha\_int*, because the value of it will be used during the boot process of the installation of nodes via iPXE, if PXE-boot is enabled.

- *ip*: IPv4 address of the node
- *v6ip*: IPv6 address of the node; optional
- *netmask*: IPv4 netmask
- *v6netmask*: IPv6 netmask
- *gateway*: IPv4 gateway address
- *v6gateway*: IPv6 gateway address
- *shared\_ip*: shared IPv4 address of the pair of nodes; this is a list of addresses
- *shared\_v6ip*: shared IPv6 address of the pair of nodes; optional; this is a list of addresses
- *shared\_ip\_only*: Boolean switch ('yes' or 'no') to enable usage with only a shared floating IPv4 address, without a static IPv4 address configured. To prevent accidental misconfiguration, this usage mode must be explicitly enabled. This usage mode is disallowed for certain interface types (e.g. 'ssh', 'mon', or 'ha').
- *shared\_v6ip\_only*: same as above, but for IPv6
- *advertised\_ip*: the IP address that is used in SIP messages when Sipwise C5 system is behind NAT/SBC. For example when running Sipwise C5 in a cloud environment, the server might not have a public IP. Then *load-balancer* component of Sipwise C5 needs to know what his public domain is ( *advertised\_ip*).
- *type*: type of services that the node provides; these are usually the VLANs defined for a particular Sipwise C5 system.

**NOTE** | You can assign a type only once per node.

Available types are:

`api_int`: internal, API-based communication interface. It is used for the internal communication of such services as faxserver, fraud detection and others.

`aux_ext`: interface for potentially insecure external components like remote system log collection service.

**NOTE**

For example the *CloudPBX* module can use it to provide time services and remote logging facilities to end customer devices. The type 'aux\_ext' is assigned to *lo* interface by default. If it is needed to expose this type to the public, it is recommended to assign the type *aux\_ext* to a separate VLAN interface to be able to limit or even block the incoming traffic easily via firewalling in case of emergency, like a (D)DoS attack on external services.

`mon_ext`: remote monitoring interface (e.g. SNMP)

`rtp_ext`: main (external) interface for media traffic

`sip_ext`: main (external) interface for SIP signalling traffic between NGCP and other SIP endpoints

`sip_ext_incoming`: additional, optional interface for incoming SIP signalling traffic

`sip_int`: internal SIP interface used by Sipwise C5 components (*lb*, *proxy*, etc.)

`ssh_ext`: command line (SSH) remote access interface

`ssh_int`: command line (SSH) internal NGCP access interface

`web_ext`: interface for web-based or API-based provisioning and administration

`web_int`: interface for the administrator's web panel, his API and generic internal API communication

`li_int`: used for LI (Lawful Interception) traffic routing

`ha_int`: HA (High Availability) communication interface between the services

`boot_int`: the default VLAN used to install nodes via PXE-boot method

`rtp_int`: internal interface for handling RTP traffic among Sipwise C5 nodes that may reside in greater distance from each other, like in case of a specialised NGCP configuration with centralized web / DB / proxy nodes and distributed LB nodes. (Please refer to [Cluster Sets](#) section for further details)

**NOTE**

Please note that, apart from the standard ones described so far, there might be other *types* defined for a particular Sipwise C5 system.

- `vlan_raw_device`: tells which physical interface is used by the particular VLAN
- `post_up`: routes can be defined here (interface-based routing), for example:

`post_up`:

```
- route add -host 203.0.113.42 gw 192.168.1.1 dev v1an70
- route add -net 10.11.12.0/21 gw 192.168.1.2 dev v1an300
- route del -host 203.0.113.42 gw 192.168.1.1 dev v1an70
- route del -net 10.11.12.0/21 gw 192.168.1.2 dev v1an300
```

- `bond_XY`: specific to "bond0" interface only; these contain Ethernet bonding properties

## 10.2. Advanced Network Configuration

You have a typical deployment now and you are good to go, however you may need to do extra configuration depending on the devices you are using and functionality you want to achieve.

### 10.2.1. Additional entries in `/etc/hosts`

The file `/etc/hosts` is generated by a template, containing entries for basic host configuration (localhost and basic IPv4/IPv6), and the IPs of other nodes in PRO/CARRIER configurations.

To add extra entries in this file, it can be done in several ways:

- `etc_hosts_global_extra_entries` at the global level, added to all hosts
- `etc_hosts_global_extra_entries` at the host level, which overrides the global one if for some reason the whole content is undesired for a particular host (e.g. to have some but not all of the "default" global entries)
- `etc_hosts_local_extra_entries` at the host level, which are added only to the hosts where this entry is present, if for some reason it is desired to have extra entries only visible in some subset of the hosts

The behaviour is the same in all cases, to append the entries directly to `/etc/hosts`.

Example of both in a configuration file:

```
---
hosts_common:
  etc_hosts_global_extra_entries:
  - 10.100.1.1 server-1 server-1.internal.example.com
  - 10.100.1.2 server-2 server-2.internal.example.com
hosts:
  db01b:
    etc_hosts_local_extra_entries:
    - 127.0.1.1 local-alias-1.db01b
    - 127.0.2.1 local-alias-2.db01b
    - 172.30.52.180 db01b.example.com
    ...
  web01a:
    etc_hosts_local_extra_entries:
    - 127.0.1.1 local-alias-1.web01a
    - 127.0.2.1 local-alias-2.web01a
    - 172.30.52.168 web01a.example.com
    etc_hosts_global_extra_entries:
    - 10.100.1.1 server-1 server-1.internal.example.com
    ...
```

With this, the additional output in `/etc/hosts` for `db01b` will be:

```
# local extra entries for host 'db01b'
```

```
127.0.1.1 local-alias-1.db01b
127.0.2.1 local-alias-2.db01b
172.30.52.180 db01b.example.com

# global extra entries
10.100.1.1 server-1 server-1.internal.example.com
10.100.2.1 server-2 server-2.internal.example.com
```

and in web01a:

```
# local extra entries for host 'web01a'
127.0.1.1 local-alias-1.web01a
127.0.2.1 local-alias-2.web01a
172.30.52.168 web01a.example.com

# global extra entries overridden for host 'web01a'
10.100.1.1 server-1 server-1.internal.example.com
```

## 10.2.2. Extra SIP Sockets

By default, the load-balancer listens on the UDP and TCP ports 5060 (*kamailiolbport*) and TLS port 5061 (*kamailiolbtlsport*). If you need to setup one or more extra SIP listening ports or IP addresses in addition to those standard ports, please edit the *kamailiolbextra\_sockets* option in your */etc/ngcp-config/config.yml* file.

The correct format consists of a label and value like this:

```
extra_sockets:
  port_5064: udp:10.15.20.108:5064
  test: udp:10.15.20.108:6060
```

The label is shown in the *outbound\_socket* peer preference (if you want to route calls to the specific peer out via specific socket); the value must contain a transport specification as in example above (udp, tcp or tls). After adding execute `ngcpcfg apply`:

```
ngcpcfg apply 'added extra socket'
ngcpcfg push all
```

The direction of communication through this SIP extra socket is incoming+outgoing. The Sipwise C5 will answer the incoming client registrations and other methods sent to the extra socket. For such incoming communication no configuration is needed. For the outgoing communication the new socket must be selected in the *outbound\_socket* peer preference. For more details read the next section [Extra SIP and RTP Sockets](#) that covers peer configuration for SIP and RTP in greater detail.

### IMPORTANT

In this section you have just added an extra SIP socket. RTP traffic will still use your *rtp\_ext* IP address.

### 10.2.3. Extra SIP and RTP Sockets

If you want to use an additional interface (with a different IP address) for SIP signalling and RTP traffic you need to add your new interface in the `/etc/network/interfaces` file. Also the interface must be declared in `/etc/ngcp-config/network.yml`.

Suppose we need to add a new SIP socket and a new RTP socket on VLAN 100. You can use the `ngcp-network` tool for adding interfaces without having to manually edit this file: On a PRO system that would be:

```
ngcp-network --set-interface=eth0.100 --host=sp1 --ip=auto
--netmask=auto --hwaddr=auto --type=sip_ext_incoming --type=rtp_int_100
ngcp-network --set-interface=eth0.100 --host=sp2 --ip=auto
--netmask=auto --hwaddr=auto --type=sip_ext_incoming --type=rtp_int_100
```

On a CARRIER system that would be:

```
ngcp-network --set-interface=eth0.100 --host=lb01a --ip=auto
--netmask=auto --hwaddr=auto --type=sip_ext_incoming
ngcp-network --set-interface=eth0.100 --host=lb01b --ip=auto
--netmask=auto --hwaddr=auto --type=sip_ext_incoming
ngcp-network --set-interface=eth0.100 --host=prx01a --ip=auto
--netmask=auto --hwaddr=auto --type=rtp_int_100
ngcp-network --set-interface=eth0.100 --host=prx01b --ip=auto
--netmask=auto --hwaddr=auto --type=rtp_int_100
```

On a PRO system the generated files would look like:

```
sp1:
..
..
  eth0.100:
    hwaddr: ff:ff:ff:ff:ff:ff
    ip: 192.168.1.2
    netmask: 255.255.255.0
    shared_ip:
      - 192.168.1.3
    shared_v6ip: ~
    type:
      - sip_ext_incoming
      - rtp_int_100
..
..
  interfaces:
    - lo
    - eth0
    - eth0.100
    - eth1
..
```

```

..
sp2:
..
..
  eth0.100:
    hwaddr: ff:ff:ff:ff:ff:ff
    ip: 192.168.1.4
    netmask: 255.255.255.0
    shared_ip:
      - 192.168.1.3
    shared_v6ip: ~
    type:
      - sip_ext_incoming
      - rtp_int_100
..
..
  interfaces:
    - lo
    - eth0
    - eth0.100
    - eth1

```

On a CARRIER system the generated files would look like:

```

lb01a:
..
..
  eth0.100:
    hwaddr: ff:ff:ff:ff:ff:ff
    ip: 192.168.1.2
    netmask: 255.255.255.0
    shared_ip:
      - 192.168.1.3
    shared_v6ip: ~
    type:
      - sip_ext_incoming
..
..
  interfaces:
    - lo
    - eth0
    - eth0.100
    - eth1
..
..
prx01a:
..
..
  eth0.100:
    hwaddr: ff:ff:ff:ff:ff:ff
    ip: 192.168.1.20

```

```
netmask: 255.255.255.0
shared_ip:
  - 192.168.1.30
shared_v6ip: ~
type:
  - rtp_int_100
..
..
interfaces:
  - lo
  - eth0
  - eth0.100
  - eth1
..
..
lb01b:
..
..
eth0.100:
  hwaddr: ff:ff:ff:ff:ff:ff
  ip: 192.168.1.4
  netmask: 255.255.255.0
  shared_ip:
    - 192.168.1.3
  shared_v6ip: ~
  type:
    - sip_ext_incoming
..
..
interfaces:
  - lo
  - eth0
  - eth0.100
  - eth1
..
..
prx01b:
..
..
eth0.100:
  hwaddr: ff:ff:ff:ff:ff:ff
  ip: 192.168.1.40
  netmask: 255.255.255.0
  shared_ip:
    - 192.168.1.30
  shared_v6ip: ~
  type:
    - rtp_int_100
..
..
interfaces:
  - lo
```

- eth0
- eth0.100
- eth1

As you can see from the above example, extra SIP interfaces must have type *sip\_ext\_incoming*. While *sip\_ext* should be listed only once per host, there can be multiple *sip\_ext\_incoming* interfaces. The direction of communication through this SIP interface is incoming only. The Sipwise C5 will answer the incoming client registrations and other methods sent to this address and remember the interfaces used for clients' registrations to be able to send incoming calls to him from the same interface.

In order to use the interface for the outbound SIP communication it is necessary to add it to *extra\_sockets* section in */etc/ngcp-config/config.yml* and select in the *outbound\_socket* peer preference. So if using the above example we want to use the *vlan100* IP as source interface towards a peer, the corresponding section may look like the following:

```
extra_sockets:
  port_5064: udp:10.15.20.108:5064
  test: udp:10.15.20.108:6060
  int_100: udp:192.168.1.3:5060
```

The changes have to be applied:

```
ngcpcfg apply 'added extra SIP and RTP socket'
ngcpcfg push all
```

After applying the changes, a new SIP socket will listen on IP 192.168.1.3 on a CARRIER in the lb01 node and this socket can now be used as source socket to send SIP messages to your peer for example. In above example we used label 'int\_100'. So the new label "int\_100" is now shown in the *outbound\_socket* peer preference.

Also, RTP socket is now listening on 192.168.1.3 on a PRO, and 192.168.1.30 on a CARRIER prx01 node and you can choose the new RTP socket to use by setting parameter *rtp\_interface* to the Label "int\_100" in your Domain/Subscriber/Peer preferences.

#### 10.2.4. Alternative RTP Interface Selection Using ICE

Normally, each interface that was configured with a type that starts with 'rtp\_' can be selected individually as RTP interface in the Domain/Subscriber/Peer preferences. For example, if the interface types 'rtp\_ext', 'rtp\_int', and 'rtp\_int\_100' have been configured, the Domain/Subscriber/Peer preferences will allow the RTP interfaces to be selected as either 'ext', 'int', or 'int\_100' in addition to "default".

The same 'rtp\_' interface type can be configured on multiple interfaces. If this is the case, and if ICE ('Interactive Connectivity Establishment') is enabled for a Domain/Subscriber/Peer, it is possible to use ICE to automatically negotiate which interface should be used for RTP communications. ICE must be supported by the remote client for this to work.

For example, 'rtp\_ext' can be configured on multiple interfaces like so (abbreviated):

```

..
..
  eth0.100:
    type:
      - rtp_ext
..
  eth0.150:
    type:
      - rtp_ext
..
  eth1:
    type:
      - rtp_ext
..
..

```

In this example, the RTP interface 'ext' will be available for selection in the Domain/Subscriber/Peer preferences. If selected and if ICE is enabled, the addresses of all three interfaces will be presented to the remote client, and ICE will be used to negotiate which one of them will be used for communications. This can be useful in multi-homed environments, or when remote clients are on private networks.

### 10.2.5. Extended RTP Port Range Using Multiple Interfaces

If the RTP port range configured via the config.yml keys rtpengine.minport and rtpengine.maxport is not sufficient to handle all concurrent calls, it is possible to load-balance the RTP ports across multiple interfaces. This is useful if the RTP proxy runs out of ports and if not enough additional ports are available.

To enable this, multiple interfaces with different addresses must be configured, and interface types of the format 'rtp\_NAME:SUFFIX' must be assigned to them. For example, if the RTP interface named 'ext' should be load-balanced across three interfaces, they can be configured like so (abbreviated):

```

..
..
  eth0.100:
    type:
      - rtp_ext:1
..
  eth0.150:
    type:
      - rtp_ext:2
..
  eth1:
    type:
      - rtp_ext:3
..
..

```

In this example, all three given RTP interface types will be available for selection in the Domain/Subscriber/Peer preferences individually (as 'ext:1' and so on), but in addition to that, an interface named just 'ext' will also be available for selection. If 'ext' is selected, only one of the three RTP interfaces will be selected in a round-robin fashion, thus increasing the number of available RTP ports threefold. The round-robin algorithm only selects an interface if it actually has RTP ports available.

## 10.2.6. Cluster Sets

In a Sipwise C5 CARRIER system it is possible to have geographically distributed nodes in the same logical Sipwise C5 unit. Such a configuration typically involves the following elements:

- **centralised** management (*web*), database (*db*) and proxy (*prx*) nodes: these provide all higher level functionality, like system administration, subscriber registration, call routing, etc.
- **distributed** load balancer (*lb*) nodes: these serve as SBCs for the whole Sipwise C5 and handle SIP and RTP traffic to / from SIP endpoints (e.g. subscribers); and they also communicate with the central elements of Sipwise C5 (e.g. proxy nodes)

In case of such an Sipwise C5 node configuration it is possible to define *cluster sets* which are collections of Sipwise C5 nodes providing the load balancer functionality.

Cluster sets can be assigned to subscriber *domains* or *SIP peers* and will determine the route of SIP and RTP traffic for those sets of SIP endpoints:

- For *SIP peers* the selected nodes will be used to send outbound SIP traffic through
- For both *SIP peers* and subscriber *domains* the selected nodes will provide RTP relay functionality (the *rtengine* Sipwise C5 component will run on those nodes)

### Configuration of Nodes of Cluster Sets

There are 2 places in NGCP's main configuration files where an entry for cluster sets must be inserted:

1. Declaration of cluster sets

This happens in `/etc/ngcp-config/config.yml` file, see an example below:

```
cluster_sets:
  default:
    dispatcher_id: 50
    default_set: default
  poland:
    dispatcher_id: 51
  type: distributed
```

Configuration entries are:

<label>: an arbitrary label of the cluster set; in the above example we have 2 of them: default and poland; the cluster set default is always defined, even if cluster sets are not used

<label>.dispatcher\_id: a unique, numeric value that identifies a particular cluster set

default\_set: selects the default cluster set

type: the type of cluster set; can be central or distributed

## 2. Assignment of cluster sets

This happens in `/etc/ngcp-config/network.yml` file, see an example below:

```
.
.
lb03a:
  .
  .
  vlan792:
    cluster_sets:
      - poland
    hwaddr: 00:00:00:00:00:00
    ip: 172.30.61.37
    netmask: 255.255.255.240
    shared_ip: 172.30.61.36
    type:
      - sip_int
    vlan_raw_device: bond0
```

In the network configuration file typically the load balancer (*lb*) nodes are assigned to cluster sets. More precisely: network interfaces of load balancer nodes that have `sip_int` type—that are used for SIP signalling and NGCP's internal *rtengine* command protocol—are assigned to cluster sets.

In order to do such an assignment a cluster set's label has to be added to the `cluster_sets` parameter, which is a list.

After modifying network configuration with cluster sets, the new configuration must be applied in the usual way:

```
> ngcpcfg apply 'Added cluster sets'
> ngcpcfg push all
```

## Configuration of Cluster Sets for SIP and RTP Traffic

For both SIP peers and subscriber domains you can select the cluster set labels predefined in `config.yml` file.

- **SIP peers:** In order to select a particular cluster set for a SIP peer you have to navigate to *Peerings select the peering group select the peering server Preferences NAT and Media Flow Control* and then *Edit lbtrtp\_set* parameter.

## Peer Host "Vlada01" - Preferences

← Back
★ Flash Dialogic
Expand Groups

Access Restrictions

Number Manipulations

NAT and Media Flow Control

Attribute	Name	Value	
use_rtpproxy	RTP-Proxy Mode	Always with plain SDP	
ipv46_for_rtpproxy	IPv4/IPv6 bridging mode	Auto-detect	
lbrtp_set	The cluster set used for SIP lb and RTP	None	Edit
rtp_interface	RTP Interface	default	

Figure 221. Select Cluster Set for a Peer

- **Domains:** In order to select a particular cluster set for a domain you have to navigate to *Domains* select the domain *Preferences NAT and Media Flow Control* and then *Edit lbrtp\_set* parameter.

## Domain "195.185.37.60" - Preferences

← Back
Expand Groups

Call Blockings

Access Restrictions

Number Manipulations

NAT and Media Flow Control

Attribute	Name	Value	
sound_set	System Sound Set		
no_nat_sipping	Disable NAT SIP pings	<input type="checkbox"/>	
use_rtpproxy	RTP-Proxy Mode	Always with plain SDP	
ipv46_for_rtpproxy	IPv4/IPv6 bridging mode	Auto-detect	
bypass_rtpproxy	Disable RTP-Proxy in the selected case	Never	
lbrtp_set	The cluster set used for SIP lb and RTP	None	Edit
rtp_interface	RTP Interface	default	

Figure 222. Select Cluster Set for a Domain

# Chapter 11. Software Upgrade

Sipwise C5 can be upgraded to mr26.0.1 from previous LTS release, or any non-LTS release since the previous LTS-release.

The mr26.0.1 maintenance release uses the new upgrade approach commonly known as '[A/B Upgrade](#)'

ngcp-upgrade requires a special partitioning schema of disk subsystem. The server has 3 separate partitions:

ngcp-data - it stores data files, like databases files, logs, etc.

ngcp-root and ngcp-fallback - they are equal size and contain the software, OS files and NGCP packages. One of them is the current root '/' partition, the another one is mounted as /ngcp-fallback directory.

See more details in [The default disk partitions](#)

During the upgrade the second partition is formatted and the target version is installed into it. After the reboot the system will be started from this partition and previous one becomes the /ngcp-fallback directory.

## WARNING

Please, pay particular attention that this partitioning schema is mandatory and if your system doesn't have it - create it beforehand. You can reinstall node from the peer and re-join the cluster. **WARNING:** This is the only supported upgrade schema. The old, in-place upgrade is not supported and technically not possible.

## 11.1. Release Notes

Please find the complete release notes and changelog of Sipwise C5 version mr26.0.1 [on our WEB site](#).

## 11.2. Overview

The Sipwise C5 software upgrade procedure to mr26.0.1 will perform several fundamental tasks, and it's split into 2 stages:

First stage:

- do pre-upgrade checks
- format fallback partition
- install Debian to fallback partition
- install NGCP packages to fallback partition
- copy current configuration to fallback partition
- upgrade the NGCP configuration schema in fallback partition
- update grub configuration so after reboot the current fallback partition becomes the active one

Second stage:

- reboot to new partition. This steps needs to be taken care manually during maintenance window

- upgrade the NGCP database schema

The 1st stage is safe to run outside the maintenance window - it changes nothing on currently running system, only prepares the fallback partition.

Also it can be done in parallel on all the nodes.

**WARNING**

It still can affect the system in term of CPU, network and disk load, to download, unpack and install the packages.

**WARNING**

Grub configuration is changed so in case of any reboot (expected or not) system will be booted to mr26.0.1 partition. It won't affect the installation though as no NGCP services are run there. So if it was unintentionally you can reboot it back to previous partition via Rollback procedure.

The 2nd stage should be run during maintenance window with enabled maintenance mode in configuration.

**WARNING**

Please make sure to have remote access to the system via out-of-band management (like IPMI, iLO, IMM, iDRAC, KVM, etc)

Sipwise C5 CARRIER is a PRO-style system that has "A" and "B" sets of nodes with specific roles. The number of nodes can differ between installations and must be clarified before the upgrade at the planning stage.

The software upgrade is usually performed by Sipwise engineers according to the following steps:

- create the software upgrade plan
- execute pre-upgrade steps: patchtt, customtt, backups, checks
- perform the first stage of upgrade on all the nodes
- make all "B" nodes (on CARRIER) or the sp2 node (on PRO) active
- ensure that all "A" nodes (on CARRIER) or the sp1 node (on PRO) are standby
- enable Maintenance Mode
- perform the second stage of upgrade on all "A" nodes (on CARRIER) or the sp1 node (on PRO)
- schedule and make services switchover to all "A" nodes (on CARRIER) or the sp1 node (on PRO)
- ensure that "A" nodes (on CARRIER) or the sp1 node (on PRO) perform well (otherwise, perform a switch back)
- perform the second stage of upgrade on all "B" nodes (on CARRIER) or the sp2 node (on PRO)
- perform the system post-upgrade testing and cleanup

**WARNING**

The only allowed software upgrade path is the one described above. The nodes sp1/s2 (or a/b) MUST be used as described in this document. All the other theoretically possible upgrade scenarios can lead to unpredictable results.

## 11.3. Planning a software upgrade

Confirm the following information:

- which system should be upgraded (LAB/LIVE, country, etc.)
- the date and time schedule for each of the steps above (keeping the time zone in mind)
- a confirmed timeframe for the upgrade operation (allowed switchover timeframe)
- the basic functionality test (BFT) to be executed before the start of the software upgrade and after the switchovers to ensure that the new release does not show critical issues (the BFT scenario should be prepared by the customer engineers)
- actions to be taken if the software upgrade operation cannot be completed within the defined maintenance window
- contact persons and ways of communication in case of emergency
- ensure that the customer and/or Sipwise engineers have access to the virtual consoles of the servers: KVM, iDRAC, AMM

## 11.4. Pre-upgrade checks

It is recommended to execute the preparatory steps in this chapter a few days before the actual software upgrade. They do not cause a service downtime, so it is safe to execute them during peak hours.

### 11.4.1. Log into the NGCP standby management node

This should be web01a on CARRIER and sp1 on PRO.

**TIP** | Use the static server IP address so you can switch between the nodes.

Run the terminal multiplexer under the *sipwise* user (to reuse the Sipwise `.screenrc` settings that are convenient for working in multiple windows):

```
screen -S my_screen_name_for_ngcp_upgrade
```

Become root inside your screen session:

```
sudo -s
```

### 11.4.2. Check the overall system status

Check the overall system status:

```
ngcp-status --all
```

Make sure that the cluster health status is OK: Check the nodes in parallel, using the 'ngcp-cluster-status' command, which will perform various checks in sequence to ensure the various nodes have a consistent and healthy state.

### 11.4.3. Check access to license server and license validity

Check from within the system (better *from all nodes*, for extra safety) that the license server is accessible from the network point of view, and that these commands do not end with timeouts or HTTP errors:

```
ping -c 3 -w 5 license.sipwise.com

curl --head https://license.sipwise.com/
```

Also ensure that:

- `/proc/ngcp/check` contains the string "ok" (if not, check logs)
- and that there are no errors or important warnings in `/ngcp-data/logs/licensed.log`

### 11.4.4. Evaluate and update custom modifications

For the below steps, investigate and make sure you understand why the custom modifications were introduced and if they are still required after the software upgrade. If the custom modifications are not required anymore, remove them (e.g. if a bug was fixed in the target release and the existing patch becomes irrelevant).

Create tickets to Sipwise developers to make relevant custom modifications part of the product in future releases. This allows you to get rid of the customtt files one day.

#### WARNING

If you directly change the working configuration (e.g. add custom templates or change the existing ones) for some reason, then the system must be thoroughly tested after these changes have been applied. Continue with the software upgrade preparation only if the results of the tests are acceptable.

Find the local changes to the template files:

```
ngcp-customtt-diff-helper
```

The script will also ask you if you would like to download the templates for your target release. To download the new templates separately, execute:

```
ngcp-customtt-diff-helper -d
```

In the tmp folder provided by the script, you can review the patchtt files or merge the current customtt with the new tt2 templates, creating the new customtt.tt2 files. Once you do this, archive the new patchtt/customtt files to reapply your custom modifications after the software upgrade:

```
ngcp-customtt-diff-helper -t
```

Find all available script options with the "-h" parameter.

### 11.4.5. Check system integrity

Log into all the servers.

Open separate windows for all the servers inside your "screen" session. (Press **Ctrl+a + c** to open a new window, **Ctrl+a + a** or **Ctrl+a + [0-9]** to change the window. **Ctrl+a + "** shows the list of all your windows. Use **Ctrl+a + A** to change the window names to corresponding hosts).

Changes made directly in tt2 templates will be lost after the software upgrade. Only custom changes made in customtt.tt2 or added by patchtt.tt2 files will be kept. Hence, check the system for locally modified tt2 files on **all** nodes:

```
ngcp-status --integrity
```

### 11.4.6. Check the configuration framework status

Check the configuration framework status on **all** nodes. All checks must show the "OK" result and there must be no actions required:

```
ngcpcfg status
```

On a CARRIER, check the replication on both central DB servers and on ports 3306 and 3308 of all the proxy servers. Ensure that all the proxy nodes replicate the read-only DB (127.0.0.1:3308) from the db01a node. Otherwise, discuss a special plan to address your particular configuration.

On a PRO, check the replication on both nodes.

The result must always show:

```
Slave_IO_Running: Yes  
Slave_SQL_Running: Yes  
Seconds_Behind_Master: 0
```

Test the cluster failover to see if everything works fine as well on "B" nodes (on a CARRIER) or the second node (on a PRO). On all the standby nodes execute:

```
ngcp-make-active
```

Create two test subscribers or use the credentials for existing ones. Register subscribers with the platform and perform a test call to ensure that call routing and media flow are working fine.

Run "apt-get update" on **all** nodes and ensure that you do not have any warnings and errors in the output.

#### WARNING

If the installation uses locally specified mirrors, then the mirrors must be switched to the Sipwise APT repositories (at least for the software upgrade). Otherwise, the public Debian mirrors may not provide packages for old Releases anymore or at

least provide outdated ones!

### 11.4.7. Check access to deb.sipwise.com

Ensure that both management nodes have access to deb.sipwise.com by executing the following commands on a management node:

```
ngcp-approx-cache --check --node sp1
ngcp-approx-cache --check --node sp2
```

The checks must show only *200 OK* results. If you see *cannot connect!*, *Received 404* or any other error, check these possible causes:

- A node does not have a connection to deb.sipwise.com
- The deb.sipwise.com whitelist does not have the node's public IP (IPv6) address.

### 11.4.8. Check PPA(s)

Check if there are PPA(s) in the configuration:

```
ngcpcfg get bootenv.ppa.size
```

Check if there are PPA(s) added manually:

```
cat /etc/apt/sources.list.d/sipwise_ppa.list
```

If PPA(s) are listed then consult with OPS if a new version of the PPA is required for the new to be upgraded version.

Before starting the upgrade the old PPA(s) need to be removed. If a new PPA is required then this should be in place before starting the upgrade.

### 11.4.9. License check

The Sipwise C5 enforce *software licensing* restrictions in form of a regular comparison of the licensed services and capacities against the actual usage patterns of the platform. In case some functionalities are enabled but not licensed, an error in *syslog* will be reported and the impacted services will be automatically deactivated.

Before proceeding with the upgrade, please take some time to check that all the modules not licensed are actually disabled in *config.yml* file. To verify if they are enabled execute the following commands (versions before mr10.5):

```
ngcpcfg get sems.prepaid.enable
ngcpcfg get sems.sbc.xfer.enable
ngcpcfg get pbx.enable
```

```
ngcpcfg get pushd.enable
ngcpcfg get intercept.enable
ngcpcfg get voisniff.admin_panel
ngcpcfg get voisniff.daemon.enable
ngcpcfg get voisniff.daemon.li_x1x2x3.enable
ngcpcfg get tpcc.enable
ngcpcfg get websocket.enable
```

To verify if they are enabled execute the following commands (all version including mr10.5 and later):

```
ngcpcfg get b2b.prepaid.enable
ngcpcfg get b2b.sbc.xfer.enable
ngcpcfg get pbx.enable
ngcpcfg get pushd.enable
ngcpcfg get intercept.enable
ngcpcfg get voisniff.admin_panel
ngcpcfg get voisniff.daemon.enable
ngcpcfg get voisniff.daemon.li_x1x2x3.enable
ngcpcfg get tpcc.enable
ngcpcfg get websocket.enable
```

If the output of one of the commands is 'yes' but the module is not licensed, you have to deactivate it. For example, in case of *pre-paid billing* module execute (versions before mr10.5):

```
ngcpcfg set /etc/ngcp-config/config.yml sems.prepaid.enable=no
ngcpcfg apply 'Disable prepaid module'
ngcpcfg push all
```

For example, in case of *pre-paid billing* module execute (all version including mr10.5 and later):

```
ngcpcfg set /etc/ngcp-config/config.yml b2b.prepaid.enable=no
ngcpcfg apply 'Disable prepaid module'
ngcpcfg push all
```

### WARNING

Please, pay particular attention to *pre-paid billing* module because it is enabled by default.

## 11.4.10. KeyDB to Valkey Migration

If not done already after the upgrade to mr12.5.x version, please migrate the key-value database from KeyDB to Valkey. See the [Appendix](#) chapter for detailed information about the steps to execute.

## 11.4.11. Corosync Transport Change

As part of the improvement in the transport communication in Corosync, it is necessary to change the transport option from 'udp' to 'knet' prior to a release upgrade. Before starting with the change, ensure that you have the latest ngcp-system-tools package:

```
ngcp-approx-cache-helper -a
apt update
apt install -y ngcp-system-tools-pro
ngcp-parallel-ssh neighbours "apt update ; apt install -y ngcp-system-
tools-pro"
```

**WARNING**

Please schedule a maintenance window for this activity, as services can be impacted during the execution of this change.

Once you have installed the latest `ngcp-system-tools` package, enable the maintenance mode:

```
ngcpcfg set /etc/ngcp-config/maintenance.yml "general.maintenance=yes"
ngcpcfg apply 'Enable Maintenance'
ngcpcfg push all
ngcp-parallel-ssh active 'crm maintenance on'
```

Now you can start with the change on the **standby** management node (web01 on Carrier):

```
ngcp-corosync-transport
```

**NOTE**

For the PRO system, you only need to run the script once. For the CARRIER system, you need to run it again on the other standby nodes (db01, prx01, lb01, etc.).

Proceed with the update of all the other **standby** nodes, if any, one after the other:

```
ngcp-corosync-transport -a
```

Disable the maintenance mode:

```
ngcpcfg set /etc/ngcp-config/maintenance.yml "general.maintenance=no"
ngcpcfg apply 'Disable Maintenance'
ngcpcfg push all
ngcp-parallel-ssh active 'crm maintenance off'
```

## 11.5. Pre-upgrade steps

**WARNING**

Ensure you are using the latest hot-fix of `ngcp-upgrade-pro` package on all nodes from current repository before proceeding.

From the management standby node run:

```
ngcp-approx-cache --update
apt update
apt install -y ngcp-upgrade-pro
```

```
ngcp-parallel-ssh neighbours "apt update ; apt install -y ngcp-upgrade-pro"
```

### 11.5.1. Download new package metadata into the approx cache (on the standby node only)

#### WARNING

Customers with far-sighted software upgrade policies usually have pre-production installations to test the services in their environment before upgrading the production platform. In this case, the approx cache should be updated on both platforms simultaneously to synchronize the package versions between them, hence consider carefully before executing this step.

To download the latest packages metadata into the approx cache, execute the following command on the **standby management** node. This action ensures that all nodes within the platform have identical packages after the software upgrade:

```
ngcp-approx-cache --update --skip-all-repos --extra-debian-release trixie --extra-ngcp-release mr26.0.1
```

### 11.5.2. Prepare the upgrade (on all the nodes)

#### WARNING

Starting from Sipwise C5 version mr13.2.1 the *man\_allowed\_ips* property will be deprecated. Any existing whitelisted IPs stored *man\_allowed\_ips* property can be migrated to the *allowed\_ips* property with the help of the `ngcp-migrate-allowed-ips` script. This script transfers all the ips set in the *man\_allowed\_ips* preference onto *allowed\_ips* for all subscribers, and domains. Additionally, the script resolves any associated conflicts should they arise. Care must be taken to run the script on the DB node in case the CARRIER platform is being used.

Run the following command on all the nodes to install the package responsible for upgrading Sipwise C5 to a newer release:

```
ngcp-prepare-upgrade mr26.0.1
```

#### NOTE

Don't worry, `ngcp-upgrade-carrier` does not exist, `ngcp-upgrade-pro` is used in Carrier too.

### 11.5.3. Run upgrade checks (on all the nodes)

There is a list of checks before the actual upgrade so it's wise to run them beforehand to detect and fix all the issues.

```
ngcp-upgrade-pre-checks mr26.0.1
```

### 11.5.4. ngcp-upgrade options

The following options in `ngcp-upgrade` can be specially useful in some instances of upgrade:

- **--step-by-step**: confirm before proceeding to next step. With this option the upgrade operation is performed confirming every step before execution, with the possibility to instruct to continue without confirming further steps until the end (if confirmation is only needed for some steps at the beginning).
- **--pause-before-step STEP\_NAME**: pause execution before step, given by the name of the script (e.g. "backup\_mysql\_db"). This option can be useful in several scenarios, for example:
  - to help to debug problems or work around known problems during upgrades. In this case the operator can pause at a given step known to be problematic or right before a problematic set, perform some manual checks or changes, then continue the upgrade until another step (with confirmation like with the recent option **--step-by-step**), or continue without stop until the end
  - another use might be to help to speed up upgrades when it involves several nodes: they can all proceed in parallel when it's known to be safe to do so; then perform some parts in lock-step (some nodes waiting until others finish with some stage); then continue in parallel until the end
- **--skip-db-backup**: This will speed-up the process in cases where it's deemed unnecessary, and this is very likely in the upgrade of nodes other than the first.

## 11.6. Upgrading Sipwise C5 CARRIER

Log in to all nodes and execute the checks from [Pre-upgrade checks](#) again. This will ensure that nothing was broken since the preparation steps were finished. Also, execute **ngcpcfg show** and **ngcpcfg status** to check the latest configuration changes.

Perform the BFT test.

Make sure you are prepared to spend about four hours upgrading the system. Note that a short service downtime is possible during the services switchover to the upgraded nodes.

#### NOTE

If there is an error during the upgrade, the `ngcp-upgrade` script will request you to solve it. Once you've fixed the problem, execute **ngcp-upgrade** again and it will continue from the previous step.

The upgrade script will ask you to confirm that you want to start. Read the given information **carefully**, and if you agree, proceed with `y`.

### 11.6.1. The custom modification handling (optional)

During the execution of `ngcp-upgrade`, in step **place\_customtt\_files**, you will be asked to place `customtt/patchtt` files for the new system to `/ngcp-fallback/etc/ngcp-config` folder. It is important to repeat this step in all the nodes, because some `customtts` may affect the network configuration and thus they have to be available immediately after the reboot of each node.

If, after upgrading all "A" nodes and promoting them to active ones, you found that you need to change something in `customtt/patchtt` files - do it, execute **ngcpcfg apply**, and push commit to shared storage. Do not push it to all the nodes but upgraded ones only (all "A" nodes).

### 11.6.2. First stage of upgrade

You can run 1st stage outside the maintenance window. Also you can run this stage in parallel on all the nodes ("A" and "B" ones) except the very first node that has to be upgraded alone.

To do this run the upgrade script on the nodes as *root*:

```
ngcp-upgrade --target mr26.0.1
```

There is "stop" step in upgrade scenario, ngc-upgrade stops there. At this time the new system in fallback partition is ready.

### 11.6.3. Enable Maintenance Mode

The maintenance mode of the Sipwise C5 will disable some background services (for instance: *ngcp-mediator*) during the software upgrade. It thus prevents the system from getting into an inconsistent state while the upgrade is being performed. You can activate maintenance mode by applying a simple configuration change on the **standby management** node as described later.

- Pull pending configuration (if any):

```
ngcpcfg pull
```

- Enable maintenance mode:

```
ngcpcfg set /etc/ngcp-config/maintenance.yml "general.maintenance=yes"
```

- Apply configuration changes by executing:

```
ngcpcfg apply 'Enabling maintenance mode before the upgrade to mr26.0.1'  
ngcpcfg push all  
ngcp-parallel-ssh active 'crm maintenance on'
```

### 11.6.4. Second stage of upgrade

#### Upgrading the standby management node "A" (web01a/db01a)\*

**NOTE** | Sometimes the DB and MGMT roles are assigned to the same host. This is OK.

**WARNING** | Do NOT run the second stage on management and db node in parallel!

Switch boot record, run as *root*:

```
/usr/share/ngcp-upgrade/ngcp-prepare-second-stage
```

**Reboot** the management node and, when it is up and running again, run as *root*:

```
ngcp-upgrade --target mr26.0.1
```

### Upgrading the standby database node "A" (db\*a)

#### NOTE

If the DB and MGMT roles are assigned to the same host, then skip this step as you have already upgraded the standby MGMT node "A" above.

Switch boot record, run as *root*:

```
/usr/share/ngcp-upgrade/ngcp-prepare-second-stage
```

**Reboot** the database node and, when it is up and running again, run as *root*:

```
ngcp-upgrade --target mr26.0.1
```

#### NOTE

It is important to upgrade db01a node *before* upgrading any proxy nodes. Otherwise, the "local" MySQL (127.0.0.1:3308) on proxy nodes may become out of sync in case the new release has `_not_replicated.up` DB statements.

### Upgrading other standby nodes "A" (lb\*a/prx\*a)

This part of the upgrade can be done in parallel on other "A" nodes.

Switch boot record, run as *root*:

```
/usr/share/ngcp-upgrade/ngcp-prepare-second-stage
```

**Reboot** the node and, when it is up and running again, run as *root*:

```
ngcp-upgrade --target mr26.0.1
```

### Useful options in `ngcp-upgrade`

The following options in `ngcp-upgrade` can be useful for this phase of upgrades, because it is very likely that the backup was already performed:

- **`--skip-db-backup`**: This will speed-up the process in cases where it's deemed unnecessary.

See a more detailed description of the options in: [ngcp-upgrade options](#)

### Promote ALL standby nodes "A" to active.

#### WARNING

Ensure that all standby nodes "A" are: \* upgraded to the new release (check `/etc/ngcp_version` or use `'ngcp-cluster-status'`)

Prior to the promotion, the DB has to be updated with information from the new configuration. This should be done as close as possible to the activation of the upgraded nodes, to minimize the changes to the active service with the old release.

Execute on one of the standby nodes as *root*, for example on db01a:

```
UPGRADE_VERSION=mr26.0.1 MYSQL_VALUES_UPDATE_BEFORE_SWITCHOVER=true
/etc/ngcp-config/templates/etc/ngcp-provisioning-
tools/mysql_values.cfg.services
```

On all "A" nodes run:

```
ngcp-make-active
```

Ensure that the "A" nodes became active, by executing the *'ngcp-status'* and *'ngcp-cluster-status'* commands described above.

Ensure that ALL "B" nodes are standby now!

### Upgrading ALL standby nodes "B" (web\*b/db\*b/lb\*b/prx\*b)

#### NOTE

You can upgrade all standby "B" nodes simultaneously (including the ones with the mgmt and db roles).

Switch boot record, run as *root*:

```
/usr/share/ngcp-upgrade/ngcp-prepare-second-stage
```

**Reboot** the node and, when it is up and running again, run as *root*:

```
ngcp-upgrade --target mr26.0.1
```

### Useful options in **ngcp-upgrade**

The following options in **ngcp-upgrade** can be useful for this phase of upgrades:

- **--step-by-step**: confirm before proceeding to next step.
- **--pause-before-step STEP\_NAME**: pause execution before step, given by the name of the script (e.g. "backup\_mysql\_db").

See a more detailed description of the options in: [ngcp-upgrade options](#)

## 11.7. Upgrading Sipwise C5 PRO

Make sure you are prepared to spend about two hours upgrading the system. Note that a short service downtime is possible during the services switchover to the upgraded node.

Start with the software upgrade on the standby sp1 node. Then, switch the services over to the upgraded node and upgrade the other (now standby) sp2 node, as described in the steps below.

**NOTE**

If there is an error during the upgrade, the `ngcp-upgrade` script will request you to solve it. Once you've fixed the problem, execute `ngcp-upgrade` again and it will continue from the previous step.

The upgrade script will ask you to confirm that you want to start. Read the given information **carefully**, and if you agree, proceed with `y`.

### 11.7.1. The custom modification handling (optional)

During the execution of `ngcp-upgrade`, in step **place\_customtt\_files**, you will be asked to place `customtt/patchtt` files for the new system to `/ngcp-fallback/etc/ngcp-config` folder. It is important to repeat this step in both the nodes, because some `customtts` may affect the network configuration and thus they have to be available immediately after the reboot of each node.

If, after upgrading the 1st node and promoting it to active one, you found that you need to change something in `customtt/patchtt` files - do it, execute `ngcpcfg apply`, and push commit to shared storage. But do not push changes to 2nd node as it still running old system.

### 11.7.2. First stage of upgrade

You can run 1st stage outside the maintenance window.

To do this run the upgrade script on the nodes as `root`:

```
ngcp-upgrade --target mr26.0.1
```

There is "stop" step in upgrade scenario, `ngcp-upgrade` stops there. At this time the new system in fallback partition is ready.

### 11.7.3. Enable Maintenance Mode

The maintenance mode of the Sipwise C5 will disable some background services (for instance: `ngcp-mediator`) during the software upgrade. It thus prevents the system from getting into an inconsistent state while the upgrade is being performed. You can activate maintenance mode by applying a simple configuration change on the **standby** node as described later.

- Pull pending configuration (if any):

```
ngcpcfg pull
```

- Enable maintenance mode:

```
ngcpcfg set /etc/ngcp-config/maintenance.yml "general.maintenance=yes"
```

- Apply configuration changes by executing:

```
ngcpcfg apply 'Enabling maintenance mode before the upgrade to mr26.0.1'
ngcpcfg push all
ngcp-parallel-ssh active 'crm maintenance on'
```

### 11.7.4. Second stage of upgrade

On the standby node switch the boot record, run as *root*:

```
/usr/share/ngcp-upgrade/ngcp-prepare-second-stage
```

**Reboot** the standby node and, when it is up and running again, run as *root*:

```
ngcp-upgrade --target mr26.0.1
```

#### Useful options in `ngcp-upgrade`

The following options in `ngcp-upgrade` can be useful for this phase of upgrades:

- **--step-by-step**: confirm before proceeding to next step.
- **--pause-before-step STEP\_NAME**: pause execution before step, given by the name of the script (e.g. "backup\_mysql\_db").

See a more detailed description of the options in: [ngcp-upgrade options](#)

### 11.7.5. Promote the upgraded standby node to active

Prior to the promotion, the DB has to be updated with information from the new configuration. This should be done as close as possible to the activation of the upgraded node, to minimize the changes to the active service with the old release.

Execute on the current standby node as *root*:

```
UPGRADE_VERSION=mr26.0.1 MYSQL_VALUES_UPDATE_BEFORE_SWITCHOVER=true
/etc/ngcp-config/templates/etc/ngcp-provisioning-
tools/mysql_values.cfg.services
ngcp-make-active
```

Ensure that the node became active, by executing the `'ngcp-status'` and `'ngcp-cluster-status'` commands described above.

### 11.7.6. Upgrade the second PRO node

On the new standby node switch the boot record, run as *root*:

```
/usr/share/ngcp-upgrade/ngcp-prepare-second-stage
```

**Reboot** the new standby node and, when it is up and running again, run as *root*:

```
ngcp-upgrade --target mr26.0.1
```

### Useful options in `ngcp-upgrade`

The following options in `ngcp-upgrade` can be useful for this phase of upgrades, because it is very likely that the backup was already performed in the upgrade of the first node:

- **`--skip-db-backup`**: This will speed-up the process in cases where it's deemed unnecessary.

See a more detailed description of the options in: [ngcp-upgrade options](#)

## 11.8. Post-upgrade steps

### 11.8.1. KeyDB to Valkey Migration

If not done already before the upgrade, please migrate the key-value database from KeyDB to Valkey. See the [Appendix](#) chapter for detailed information about the steps to execute.

### 11.8.2. Soundset migration

As anticipated in the release notes, starting from Sipwise C5 version mr11.3.1 the Soundset inheritance feature has been added. Every *Sound\_Set* can have a parent *Sound\_Set*: if the parent is configured, all the announcements not defined in the current *Sound\_Set* will be inherited from the parent, if any. Additionally the *Contract\_Sound\_Set* has been extended to contain all the announcements available in the standard *Sound\_Set*. In case both of the sound set types are assigned to a subscriber, the *Contract\_Sound\_Set* takes precedence. This change could have an impact on systems with the CloudPBX module enabled and a mix of *Sound\_Set* and *Contract\_Sound\_Set* are used.

To proceed with the migration, please follow the steps described in the [release notes](#).

### 11.8.3. Migrate *ncos* and *ncos\_set* preferences

The exposition of the *ncos* and *ncos\_set* preferences to subscribers may have an impact on NGCP systems where system administrators used to setup *ncos* instead of *adm\_nos* to apply barrings on subscribers/domains. That change might potentially have an unintended consequence where subscribers modify the previously assigned by administrators 'ncos' preference.

**NOTE** remember that to apply administrative *ncos* that subscribers cannot edit, the system administrator have to use the preferences *adm\_ncos*, *adm\_cf\_ncos*, *adm\_ncos\_set*, *adm\_cf\_ncos\_set*.

In case if the *ncos* levels/sets were wrongly used in past, those have to be migrated to the corresponding admin level/set. This process can be easily done and automated using API or the Web interface. Alternatively, to help customer with this migration, a dedicated script called 'ngcp-migrate-adm-ncos' has been created. The script has to be run **ONLY** in systems where **ALL** the *ncos* and

`ncos_set` have to be migrated to `adm_ncos` and `adm_ncos_set` preferences. In case of a mixed environment (some preferences have to be migrated and others not) then the migration has to be done manually. The script automatically runs through all subscribers, profiles, customer and domain preferences, check for any `ncos` or `ncos_set` occurrence and migrate it to the corresponding administrative preference. The script can be called anytime after the upgrade. If no parameter is specified, the script will simply print to the standard output the list of potential conflicts in the system: in cases where both the `ncos` and the `adm_ncos` (or `ncos_set` and `adm_ncos_set`) are configured. When all the reported changes has been acknowledged by the system administrator, the script should be run again with '--apply' parameter. Further invocations of the script will not have any effect on the system.

#### 11.8.4. Disabling maintenance mode

In order to disable the *maintenance mode*, do the following:

- Pull outstanding `ngcpcfg` changes (if any):

```
ngcpcfg pull
```

- Disable the maintenance mode:

```
ngcpcfg set /etc/ngcp-config/maintenance.yml "general.maintenance=no"
```

- Apply the changes to configuration templates:

```
ngcpcfg apply 'Disable the maintenance mode after the upgrade to  
mr26.0.1'  
ngcpcfg push all  
ngcp-parallel-ssh active 'crm maintenance off'
```

#### 11.8.5. Post-upgrade checks

When everything has finished successfully, check that replication is running. Check `ngcp-status --all`. Finally, do a basic functionality test. Check the web interface, register two test subscribers and perform a test call between them to ensure call routing works.

##### NOTE

You can find a backup of some important configuration files of your existing installation under `/ngcp-data/backup/ngcp-mr26.0.1-\*` (where `\*` is a place holder for a timestamp) in case you need to roll back something at any time. A log file of the upgrade procedure is available at `/ngcp-data/ngcp-upgrade/$FROM-mr26.0.1/logs/`.

### 11.9. Applying the Latest Hotfixes

If your current release is already the latest or you prefer to be on the LTS release, we still suggest applying the latest hotfixes and critical bug fixes.

Prior to preparing your patchtt, you can check if they need to be updated with this command.

```
ngcp-customtt-diff-helper -c
```

If your patchtt needs to be updated, execute all steps as described in [Pre-upgrade checks](#). They include the system checks, customtt/patchtt preparation and others. It is important to execute all the steps from the above chapter.

On a CARRIER it is suggested to promote B-nodes to active and start the update with A-nodes.

### 11.9.1. Enable Maintenance Mode

The maintenance mode of the Sipwise C5 will disable some background services (for instance: *ngcp-mediator*) during the update. It thus prevents the system from getting into an inconsistent state while the update is being performed. You can activate maintenance mode by applying a simple configuration change on the **standby management** node as described later.

- Pull pending configuration (if any):

```
ngcpcfg pull
```

- Enable maintenance mode:

```
ngcpcfg set /etc/ngcp-config/maintenance.yml "general.maintenance=yes"
```

- Apply configuration changes by executing:

```
ngcpcfg apply 'Enabling maintenance mode before updating to the latest  
mr26.0.1 packages'  
ngcpcfg push all  
ngcp-parallel-ssh active 'crm maintenance on'
```

### 11.9.2. Update the approx cache on the standby management node

The main goal of the following command is to download the new packages into the approx cache. So all the nodes in the cluster will get identical packages.

```
ngcp-approx-cache --auto --node localhost
```

### 11.9.3. Update ngcp-system-tools package

Update the ngcp-system-tools package to the latest version to obtain the most recent ngcp-update script.

```
apt install -y ngcp-system-tools-pro  
ngcp-parallel-ssh neighbours "apt update ; apt install -y ngcp-system-
```

```
tools-pro"
```

#### 11.9.4. Apply hotfixes on the standby management node

```
ngcp-update
```

#### 11.9.5. If there are custom configuration templates

Merge/add the custom configuration templates if needed.

Apply the changes to configuration templates:

```
ngcpcfg apply 'apply customtt/patchtt after installing the latest packages'
```

Send the new templates to the shared storage and the other nodes.

```
ngcpcfg push --shared-only
```

#### 11.9.6. Apply hotfixes on all other standby nodes (CARRIER-only)

```
ngcp-update
```

#### 11.9.7. Promote the standby nodes to active

Execute on the **standby** nodes as *root*:

```
ngcp-make-active
```

Check in a minute that the nodes became active:

```
ngcp-check-active
```

#### 11.9.8. Apply hotfixes on the second node

```
ngcp-update
```

#### 11.9.9. Disable Maintenance Mode

In order to disable the *maintenance mode*, do the following:

- Pull outstanding ngcpcfg changes (if any):

```
ngcpcfg pull
```

- Disable the maintenance mode:

```
ngcpcfg set /etc/ngcp-config/maintenance.yml "general.maintenance=no"
```

- Apply the changes to configuration templates:

```
ngcpcfg apply 'Disabling maintenance mode after updating to the latest  
mr26.0.1 packages'  
ngcpcfg push all  
ngcp-parallel-ssh active 'crm maintenance off'
```

Execute the final checks as described in the **Post-upgrade checks** section.

# Chapter 12. Backup, Recovery and Maintenance

## 12.1. Sipwise C5 Backup

For any service provider it is important to maintain a reliable backup policy as it enables prompt services restoration after any force majeure event. Although the design of Sipwise C5 implies data duplication and high availability of services, we still strongly suggest you to configure a backup procedure. The Sipwise C5 has a built-in solution that can help you back up the most crucial data. Alternatively, it can be integrated with any Debian compatible backup software.

### 12.1.1. What data to back up

- The database

This is the most important data in the system. All subscriber and billing information, CDRs, user preferences, etc. are stored in the MySQL server. It is strongly recommended to have up-to-date dumps of all the databases on corresponding Sipwise C5 nodes.

- System configuration

The system configuration folder `/etc/ngcp-config/` must be included in the backup as well. It contains the system specific configuration (like SSL keys). Also you might have some local modifications. We suggest backing up the whole `/etc` folder to preserve the `etckeeper` history to be able to answer when and who changed particular configuration files in the past.

- Exported CDRs (optional)

The `/home/jail/home/cdrexpert` directory contains the exported CDRs. It depends on your call data retention policy whether or not to remove these files after exporting them to an external system.

### 12.1.2. The built-in backup solution

The Sipwise C5 comes with an easy-to-use solution that creates everyday backups of the most important data:

- The system configuration files. The whole `/etc` directory is backed up.
- Exported CDRs. The `/home/jail/home/cdrexpert` directory with csv files.
- All required databases on corresponding servers.

This functionality is disabled by default and can be enabled and configured in the `backuptools` subsection in the `config.yml` file. Please, refer to the "C.1.3 backup tools" section of the "Sipwise C5 configs overview" chapter for the backup configuration options.

Once you set the required configuration options, apply the changes:

```
ngcpcfg apply 'enable the backup feature'  
ngcpcfg push all
```

Once you activate the feature, Sipwise C5 will create backups in the off-peak time on the standby

nodes and put them to the `/ngcp-data/backup/ngcp_backup` directory, namespaced by a timestamp and the node pairname. By default it will also copy them to its peer node. It can also be configured to copy them to the 'mgmt' nodes, so that they keep a consolidated backup of the entire Carrier. You can copy these files to your backup server using `scp` or `ftp`.

**NOTE**

make sure that you have enough free disk space to store the backups for the specified number of days.

## 12.2. Recovery

In the worst case scenario, when the system needs to be recovered from a total loss, you only need 4 steps to get the services back online:

- Install Sipwise C5 as explained in chapter 2.
- Restore the `/etc/ngcp-config/` directory from the backup, overwriting your local files.
- Restore 'mysql.encryption.key' in constants.yml if new MariaDB instance/binlogs were encrypted (DB is encrypted by default). See the detailed information in [MariaDB data restoration remarks](#).
- Restore the database from the latest MySQL dump.
- Apply the changes to bring the original configuration into effect:

```
ngcpcfg apply 'restored the system from the backup'
ngcpcfg push all
```

## 12.3. Reset Database

**IMPORTANT**

All existing data will be wiped out! Use this script only if you want to clear all previously configured services and start configuration from scratch.

To reset database to its original state you can use a script provided by CE: \* Execute `ngcp-reset-db`. It will assign new unique passwords for Sipwise C5 services and reset all services. The script will also create dumps for all Sipwise C5 databases.

## 12.4. Synchronize database

In case of unresolvable database replication issues or to copy mysql data between a pair of hosts (usually a pair of sp1 and sp2 nodes).

There is a script for that: `ngcp-sync-db`.

To synchronize databases you need to run the script on your target host.

- Definitions:

'master' - remote/master host (the database is dumped from there)

'local' - target/local host (the database is imported onto)

- Usage:

**IMPORTANT**

Your existing database on 'local' will be completely wiped. The script provides a

possibility to backup both 'master' and 'local' databases during the procedure.

You can run the script with `-h` or `--help` to check its options or use `man ngcp-sync_db`

If you run it without any options it automatically calculates 'master' hostname (e.g. if you run it on 'sp2' then 'sp2'=='local' and 'sp1'=='master').

The script also requires mysql credentials and if none is provided it uses the ones from the file `/etc/mysql/sipwise_extra.cnf`. You can specify user and/or password for both 'master' and 'local'.

Before the actual start it produces a summary with settings used to the procedure and a confirmation prompt to prevent accidental usage. Making use of `--force` option however suppresses the confirmation prompt. By default no messages are printed on STDOUT (compliant to be integrated into another tools) and with `-v` or `--verbose` options you enable debugging where all the ongoing steps will be printed to STDOUT.

There are 2 modes available for synchronization, 'online' and 'backup'. By default 'online' is used where the procedure does not create any backups and everything goes on the fly. That is useful for large databases where creating backups would require solid amounts of available free disk space. With the 'backup' mode 'master' db is dumped into a backup file on 'local' first (default directory: `/ngcp-data/backup/ngcp-sync-db`) and imported upon the backup completion.

Mysql database connection to the 'master' db and the 'local' db is the essential part and by default the script tries to establish direct mysql connection however that may not be possible due to the access restrictions. To overcome that you can use `--ssh-tunnel` option and specifying there a local custom free port (e.g. `--ssh-tunnel=33125`) in this case an ssh tunnel will be created to 'master' and used to establish the db connection on the 'localhost' behalf (NOTE: Public key based ssh negotiation is required for the tunnel as the script does not support ssh credentials for security reasons).

Backups may be a subject to create during synchronization for possible rollbacks. To create the 'local' db backup you should add `--local-backup`. The 'master' db backup is automatically created only using `--sync-mode=backup`. Upon completion all those created backups are deleted and if you need to keep them please use `--keep-backups` option (NOTE: In case of errors during synchronization and when backups are created they are NOT automatically deleted. Therefore, if the script had failed with an error and afterwards completed successfully you may want to manually remove the remaining backups from `/ngcp-data/backup/ngcp-sync-db`).

- Examples:

Normal online mode synchronization 'sp1' 'sp2'.

```
sp2> ngcp-sync-db
```

Normal backup mode synchronization 'sp1' 'sp2'.

```
sp2> ngcp-sync-db --sync-mode=backup
```

Forced online mode synchronization 'sp1' 'sp2'. USE WITH CARE as there will be no confirmation prompts.

```
sp2> ngcp-sync-db --force
```

Direct mysql db access is not possible. SSH tunnel is initialised to local port 33125 and forwards all connections 127.0.0.1:33125 sp1:3306.

```
sp2> ngcp-sync-db --ssh-tunnel=33125
```

Custom mysql credentials for the 'master' db connection (by default: */etc/mysql/sipwise\_extra.cnf*)

```
sp2> ngcp-sync-db --master-user=frank --master-pass=dbconnect
```

Normal online mode synchronization 'sp1' 'sp2' with the 'local' db backup and retaining the backup. (no 'master' backup in this case as it is only available with `--sync-mode=backup`).

```
sp2> ngcp-sync-db --local-backup --keep-backups
```

Normal online mode synchronization 'custom-node' 'sp2' with ssh tunnel

```
sp2> ngcp-sync-db --master-host=custom-node --ssh-tunnel=45001
```

Forced synchronization 'custom-node' 'sp2' with ssh tunnel, backup sync mode, local backup, custom 'master' and 'local' db credentials and ports as well as a different backup dir

```
sp2> ngcp-sync-db --force --sync-mode=backup --master-host=custom-node
--master-port=3308 --ssh-tunnel=45001 --master-user=frank --master
-pass=dbconnect --local-user=john --local-pass=dblocal --local-backup
--keep-backups --backup-dir=/home/barry/backups
```

## 12.5. Accounting Data (CDR) Cleanup

Sipwise Sipwise C5 offers ways to cleanup, backup or archive old accounting data—i.e. CDRs—that is not necessary for further processing any more, or must be deleted according to the law. There are some Sipwise C5 components designed for this purpose and they are commonly called *cleantools*. These are configurable scripts that interact with NGCP's accounting and kamailio databases, or remove exported CDR files in order to clean or archive the unnecessary data.

### 12.5.1. Cleantools Configuration

The configuration parameters of *cleantools* are located in the main Sipwise C5 configuration file: */etc/ngcp-config/config.yml*. Please refer to the *config.yml* file description: [Cleantools Configuration Data](#) for configuration parameter details.

In case the system administrator needs to modify some configuration value, the new configuration

must be activated in the usual way, by running the following commands:

```
> ngcpcfg apply 'Modified cleanuptools config'
> ngcpcfg push all
```

As a result new configuration files will be generated for the accounting database and the exported CDR cleanup tools. Please read detailed description of those tools in subsequent sections of the handbook.

The Sipwise C5 system administrator can also select the time when cleanup scripts are run, by modifying the schedule here: `/etc/cron.d/cleanup-tools`

## 12.5.2. Accounting Database Cleanup

The script responsible for cleaning up the database is: `ngcp-cleanup-acc`

The configuration file used by the script is: `/etc/ngcp-cleanup-tools/acc-cleanup.conf`

An extract from a sample configuration file is provided here:

```
#####

batch = 10000
archive-target = /ngcp-data/backup/cdr
compress = gzip

username = dbcleaner
password = rcKamRdHhx7saYRbkJfP
host = localhost
port = 3306

redis-batch = 10000
redis-port = 6379

connect accounting
keep-months = 2
use-partitioning = yes
timestamp-column = cdr_start_time
backup cdr_cash_balance_data
backup cdr_time_balance_data
backup cdr_relation_data
backup cdr_tag_data
backup cdr_mos_data
backup cdr_export_status_data
backup cdr_group
timestamp-column = first_cdr_start_time
backup cdr_period_costs
timestamp-column = start_time
backup cdr

archive-months = 2
```

```
archive cdr_cash_balance_data
archive cdr_time_balance_data
archive cdr_relation_data
archive cdr_tag_data
archive cdr_mos_data
archive cdr_export_status
archive cdr_group
archive cdr_period_costs
archive cdr

cleanup-days = 1
use-partitioning = no
timestamp-column = cdr_start_time
cleanup int_cdr_cash_balance_data
cleanup int_cdr_time_balance_data
cleanup int_cdr_relation_data
cleanup int_cdr_tag_data
cleanup int_cdr_group
cleanup int_cdr_export_status
timestamp-column = start_time
cleanup int_cdr

connect kamailio
time-column = time
cleanup-days = 90
cleanup acc

connect-redis 21
connect kamailio
time-column = time_hires
cleanup-days = 3
cleanup-mode = mysql
cleanup-redis acc:entry:*

# Clean up after mediator by deleting old leftover acc entries and
# deleting
# old entries out of acc_trash and acc_backup
connect kamailio
time-column = time
cleanup-days = 30
cleanup acc_trash
cleanup acc_backup

maintenance = no
```

The configuration file itself contains a detailed description of how database cleanup script works. It consists of a series of statements, one per line, which are going to be executed in sequence. A statement can either only set a variable to some value, or perform an action.

There are 4 types of actions the database cleanup script can take:

- backup database tables
- archive database tables
- cleanup database tables
- cleanup redis databases

These actions are discussed in following sections.

A generic action is connecting to the proper database: connect <database name>

### Backup Database Tables

The database cleanup tool can create *monthly backups* of data in the accounting database tables by moving old records to separate tables named: cdr\_YYYYMM. The instruction in the configuration file looks like: backup <table name>, by default and typically it is: backup cdr

Configuration values that govern the backup procedure are:

- time-column: The name of the column in the table to use for determining which month a record belongs to. Must be a "datetime" column.
- timestamp-column: The name of the column in the table to use for determining which month a record belongs to. Must be a "decimal(13,3)" column.
- use-partitioning: If a table is partitioned using the time-column (timestamp-column) and the value is set to "yes", then moving/deleting records are instant operations, done by managing the partitions. Otherwise the usual method is used to delete/move records by chunks.
- batch: How many rows to include per transaction when processing in chunks. If unset or 0, it does them all at once.
- keep-months: How many months worth of records to keep in the table and not move into the monthly backup tables.

IMPORTANT: Months are always processed as a whole and this specifies how many months to keep AT MOST. In other words, if the script is started on December 15th and this value is set to "2", then all of December and November is kept, and all of October will be moved out.

### Archive Database Tables

The database cleanup tool can archive (dump) old monthly tables. The statement used for this purpose is: archive <table name>, by default and typically it is: archive cdr

This creates an SQL dump out of older tables created by the backup statement and drop them from database afterwards. Archiving uses the following configuration values:

- archive-months: Uses the same logic as the "keep-months" variable. If set to "12" and the script was started on December 15th, it will start archiving with the December table of the previous year. Archiving continues month by month, going backwards in time, until the script encounters a missing table.
- archive-target: Target directory for writing the SQL dump files. If explicitly specified as "/dev/null", then no actual archiving will be performed, but instead the tables will only be dropped.
- compress: If set to "gzip", then gzip the dump files after creation. If unset, do not compress.

- host, "username" and "password": As dumping is performed by an external command, those variables are reused from the "connect" statement.

### Cleanup Database Tables

The database cleanup tool may do database table cleanup without performing backup. In order to do that, the statement: `cleanup <table name>` is used. Typically this has to be done in kamailio database, examples:

- `cleanup acc`
- `cleanup acc_trash`
- `cleanup acc_backup`

The cleanup statement works exactly like the backup statement, but doesn't actually backup anything, but rather only deletes old records. Additional configuration parameters required by the cleanup procedure:

- `cleanup-days`: Any record older than these many days will be deleted.

### Cleanup Redis Databases

With the advent of persisting kamailio.acc record data in a redis keystore, a separate `cleanup-redis <key pattern>` statement was introduced. It will remove old redis entries, whose keys match the given redis SCAN pattern. Typically this has to be done for the redis 21 database (acc records), e.g.:

- `cleanup-redis acc:entry:*`

`connect-redis <redis database number>` has to be used instead of `connect +<mariadb database name>`, which is needed to initially connect before any `<backup>`, `<archive>` and `<cleanup>` operations.

The `cleanup-redis` statement works similar to the `cleanup` statement, with some additional options below:

- `time-column`: The name of the field in a redis entry denoting the record timestamp in epoch seconds.
- `cleanup-mode`: If set to "delete", aged entries will be simply removed. If set to "mysql", they will be inserted into a database table first. The latter requires `connect` to open the database additionally.
- `redis-batch`: Chunk size of redis entries with matching keys to look at. Note that redis processing always works in chunks, there is no partitioning.
- `cleanup-days`: Any entry older than these many days will be deleted.

## 12.5.3. Exported CDR Cleanup

The script responsible for cleaning up exported CDR files is: `ngcp-cleanup-cdr-files`

The configuration file used by exported CDR cleanup script is: `/etc/ngcp-cleanup-tools/cdr-files-cleanup.yml`

A sample configuration file is provided here:

```

enable: no
max_age_days: 30
paths:
  -
    path: /home/jail/home/*/20[0-9][0-9][0-9][0-9]/[0-9][0-9]
    wildcard: yes
    remove_empty_directories: yes
    max_age_days: ~
  -
    path: /home/jail/home/cdrexpert/resellers/*/20[0-9][0-9][0-9][0-9]/[0-9][0-9]
    wildcard: yes
    remove_empty_directories: yes
    max_age_days: ~
  -
    path: /home/jail/home/cdrexpert/system/20[0-9][0-9][0-9][0-9]/[0-9][0-9]
    wildcard: yes
    remove_empty_directories: yes
    max_age_days: ~

```

The exported CDR cleanup tool deletes CDR files in the directories provided in the configuration file, if those have already expired.

Configuration values that define the files to be deleted:

- `enable`: Enable (**yes**) or disable (**no**) exported CDR cleanup.
- `max_age_days`: Gives the expiration time of the exported CDR files in days. There is a general value which may be overridden by a local value provided at a specific path. The local value is valid for the particular path only.
- `paths`: an array of path definitions
  - `path`: a path where CDR files are to be found and deleted; this may contain wildcard characters
  - `wildcard`: Enable (**yes**) or disable (**no**) using wildcards in the path
  - `remove_empty_directories`: Enable (**yes**) or disable (**no**) removing empty directories if those are found in the given path
  - `max_age_days`: the local expiration time value for files in the particular path

## 12.6. Managing packages

The Sipwise C5 uses Debian packages to deliver the code to servers. Therefore it is important to keep Debian packages installation state and version consistent across nodes in the cluster. To achieve it, Sipwise C5 uses the [Approx](#) component.

Approx is a proxy server for Debian archive files. It fetches files from remote repositories on demand, and caches them for local use. All files are always being delivered from the approx cache at the same version as they were delivered previously to all the other cluster nodes.

All approx cache files are stored in `/var/cache/approx/` on the first management type (MGMT) Carrier

nodes (normally 'web01' on Carrier) and are shared between 'web01a' and 'web01b' pair for high availability.

The following tools are available on the platform to maintain the Approx cache (call them with '--help' options to see all the possible functionality):

- [ngcp-approx-cache](#)
- [ngcp-approx-snapshots](#)

To provide all the necessary functionality, Approx distinguishes between two main types of files:

- [Repository metadata](#) (Indexes files)
- [Repository packages](#) (packages \*.deb and source \*.tar.gz files)

The first type of files 'Repository metadata' is always 'frozen' and always returned from the Approx cache. Freezing them is enough to provide the same Debian packages for all the cluster nodes. To update approx cache ('Repository metadata') users should use 'ngcp-approx-cache', to sync approx cache ('Repository metadata') between installations (LAB and PROD) users can use 'ngcp-approx-snapshots'.

The second type of files 'Repository packages' is a local cache/mirror of remote Debian servers. Every time the server requests some package, it is being checked in the Approx cache storage and returned if available (for performance reasons). If the package files are missing, they will be requested from the remote server, returned to the client and stored locally for future usage. Such an approach speeds up the installation stage (all packages are available from the LAN) and make possible to reinstall old packages state in case a cluster node needs reinstallation (e.g. disaster recovery) as all packages are available locally even if they have disappeared from the Debian servers.

To provide such a separation, Sipwise C5 has two TCP ports to use:

- Approx read-write (RW) port (by default '9999'). Managed by Approx itself.
- Approx read-only (RO) port (by default '9998'). Managed by Nginx.

All requests towards Approx RW port will overwrite the Approx cache (access to the Approx RW port is limited to the 'ha\_int' interface only). Normally ngcp-approx-cache only uses the RW port. APT source files '/etc/apt/sources.list.d/\*.list' only uses the RO port. (the Approx host is 'web01' for Carrier and 'sp' for PRO installations):

```
root@web01a:~# grep -H 9998 /etc/apt/sources.list.d/*
/etc/apt/sources.list.d/debian.list:deb http://web01:9998/debian/ trixie
main contrib non-free non-free-firmware
/etc/apt/sources.list.d/debian.list:deb http://web01:9998/debian-
security/ trixie-security main contrib non-free non-free-firmware
/etc/apt/sources.list.d/debian.list:deb http://web01:9998/debian/
trixie-updates main contrib non-free non-free-firmware
/etc/apt/sources.list.d/debian.list:deb http://web01:9998/debian-debug/
trixie-debug main contrib non-free non-free-firmware
/etc/apt/sources.list.d/sipwise.list:deb [arch=amd64]
http://web01:9998/autobuild/ release-trunk-trixie main
/etc/apt/sources.list.d/sipwise.list:#deb-src
http://web01:9998/autobuild/ release-trunk-trixie main
```

```
root@web01a:~#
```

Approx does NOT support a secure HTTP protocol (HTTPS), all connections from NGCP servers towards Approx should use the plain HTTP transport.

All connections from the Approx to external servers use HTTPS by default and can be fine-tuned in case of a HTTP/HTTPS proxy in use. The proxy servers should be configured in config.yml:

```
bootenv:
  http_proxy: ''
  https_proxy: ''
```

The custom Approx repositories can be defined using the following section in config.yml:

```
bootenv:
  custom_repos:
    - enable: no
      name: my-example-repo
      url: https://example.com/debian
    - enable: yes
      name: my-example-repo2
      url: https://example.com/myrepo
```

### 12.6.1. Maintaining the Approx cache

**NOTE** | It is recommended to create an Approx snapshot before updating the Approx cache.

The script 'ngcp-approx-cache' is designed to update the Approx cache and clean/manage it.

To update the Approx cache please use the following command:

```
ngcp-approx-cache --auto # you can add --force to skip all confirmations
```

The command above will update all the 'Repository metadata' to the latest available versions from the remote servers (pointed by APT source list files in '/etc/apt/sources.list.d/\*.list').

The tool ngcp-approx-cache should be called on the management type (MGMT) Carrier node. It is enough to execute it only once (web01a/sp1 or web01b/sp2).

To update all packages on the server from the Approx cache it is enough to call the usual Debian command:

```
apt update && apt upgrade
```

#### WARNING

Do not forget to update DB/ngcp-config if NGCP packages have been updated, and apply configuration changes: ngcp-update-db-schema && ngcp-update-cfg-

```
schema && ngcpcfg apply 'new packages'.
```

**WARNING**

To prevent unnecessary downtime always upgrade Debian packages on inactive HA node.

Also, the tool 'ngcp-approx-cache' allows to check the Approx cache consistency, clean stale packages and/or NGCP releases from the Approx cache, and more. See all the available functionality using '--help' option:

```
ngcp-approx-cache --help
```

**12.6.2. Maintaining the Approx snapshots**

An approx snapshot is the concept of having the approx cache state of a particular point in time. The approx snapshots only contain the 'Repository metadata' parts. The tool 'ngcp-approx-snapshots' is designed to create/manage/export/import approx snapshots between different installations (e.g. LAB and PROD). It allows syncing Debian packages versions between systems and guarantees installation state consistency between production and the code tested by QA in the LAB, etc.

Usage example:

On the LAB system, update approx cache, install and test new packages:

```
root@sp1:~# ngcp-approx-cache --auto --force
...
root@sp1:~# ngcp-approx-snapshots --create
Creating approx snapshot '20250929002625'...
root@sp1:~#
root@sp1:~# apt update && apt upgrade && ... && ngcp-config apply ...
...
root@sp1:~# # HACK/FIX/TEST
...
root@sp1:~# ngcp-approx-snapshots --export 20250929002625
Exporting approx snapshot '20250929002625'...
Successfully exported approx snapshot: /tmp/tmp.71CS2yjrli/ngcp-approx-
snapshot-20250929002625.gzip
root@sp1:~#
```

Copy snapshot from LAB to PROD:

```
root@sp1:~# scp /tmp/tmp.71CS2yjrli/ngcp-approx-snapshot-
20250929002625.gzip PROD:/tmp/
```

Check the versions of packages on PROD, import new approx snapshot, switch to new approx snapshot:

```
root@sp1:/var/cache# apt-cache policy ngcp-templates-pro
ngcp-templates-pro:
  Installed: 13.5.1.1+0~mr13.5.1.1
```

```

Candidate: 13.5.1.1+0~mr13.5.1.1
Version table:
*** 13.5.1.1+0~mr13.5.1.1 990
    990 http://sp:9998/spro/mr13.5.1 trixie/main amd64 Packages
    100 /var/lib/dpkg/status
root@sp1:/var/cache#

root@sp1:/var/cache# ngcp-approx-snapshots --import /tmp/ngcp-approx-
snapshot-20250929002625.gzip
Importing approx snapshot '/tmp/ngcp-approx-snapshot-
20250929002625.gzip'...
Successfully imported approx snapshot.
root@sp1:/var/cache#

root@sp1:/var/cache# ngcp-approx-snapshots --list
List of locally available snapshots:
20250929002625 | Created at 2025-09-29 00:26:25 on sp1
root@sp1:/var/cache#

root@sp1:/var/cache# ngcp-approx-snapshots --switch 20250929002625
Switching to approx snapshot...
WARNING: the active approx cache will be removed! (Snapshots created?)
Should we switch to approx snapshot '20250929002625'? (yes/no): yes
Removing the active approx cache '/var/cache/approx'...
Switching to the approx snapshot '20250929002625'
root@sp1:/var/cache#

root@sp1:/var/cache# ngcp-approx-snapshots --apt-update # to force local
repository metadata update
...
root@sp1:/var/cache# apt-cache policy ngcp-templates-pro
ngcp-templates-pro:
  Installed: 13.5.1.1+0~mr13.5.1.1
  Candidate: 13.5.1.2+0~mr13.5.1.2
  Version table:
    13.5.1.2+0~mr13.5.1.2 990
    990 http://sp:9998/spro/mr13.5.1 trixie/main amd64 Packages
*** 13.5.1.1+0~mr13.5.1.1 100
    100 /var/lib/dpkg/status
root@sp1:/var/cache#

root@sp1:~# apt update && apt upgrade && ... && ngcp-config apply

```

It is also useful to see the list of available approx snapshots (the tool `ngcp-approx-snapshots` has to be executed on the MGMT node):

```

root@sp1:~# ngcp-approx-snapshots --list
List of locally available approx snapshots:
* 20250929002625 | Created at 2025-09-29 00:26:25 on sp1
  20250928081717 | Created at 2025-09-28 08:17:17 on sp2
  20250929002625 | Created at 2025-09-28 10:17:39 on sp1 [LOCKED]

```

```
root@sp1:~#
```

The symbol "\*" above shows the currently active snapshot (it implies the content in /var/cache/approx/snapshot-info/created and /mnt/glusterfs/mgmt-share/approx\_snapshots/20250927000519/snapshot-info/created is identical).

Example for locking/unlocking snapshots (to prevent deleting by mistake):

```
root@sp1:~# ngcp-approx-snapshots --list
List of locally available approx snapshots:
* 20250929002625 | Created at 2025-09-29 00:26:25 on sp1
  20250928081717 | Created at 2025-09-28 08:17:17 on sp2
  20250928101739 | Created at 2025-09-28 10:17:39 on sp1 [LOCKED]

root@sp1:~# ngcp-approx-snapshots --delete 20250928101739
ERROR: cannot remove locked snapshots '20250928101739'

root@sp1:~# ngcp-approx-snapshots --unlock 20250928101739
Unlocked snapshot '20250928101739'

root@sp1:~# ngcp-approx-snapshots --delete 20250928101739
Deleting approx snapshot '20250928101739'

root@sp1:~# ngcp-approx-snapshots --list
List of locally available approx snapshots:
* 20250929002625 | Created at 2025-09-29 00:26:25 on sp1
  20250928081717 | Created at 2025-09-28 08:17:17 on sp2
root@sp1:~#
```

Also, it is possible to search and show all packages versions in all snapshots:

```
root@sp1:~# ngcp-approx-snapshots --search ngcp-templates-pro
Search results for the package 'ngcp-templates-pro':
  20250929002625 : 13.5.1.2+0~mr13.5.1.2 (mr13.5.1)
    active approx : 13.5.1.2+0~mr13.5.1.2 (mr13.5.1)
    apt candidate : 13.5.1.2+0~mr13.5.1.2
    apt installed : 13.5.1.1+0~mr13.5.1.1
root@sp1:~#
```

See more details in 'ngcp-approx-snapshots --help'.

# Chapter 13. Security, Performance and Troubleshooting

Once Sipwise C5 is in production, security and maintenance becomes really important. In this chapter, we'll go through a set of best practices for any production system.

## 13.1. Sipwise SSH access to Sipwise C5

The Sipwise C5 provides SSH access to the system for Sipwise operational team for debugging and final tuning. Operational team uses user 'sipwise' which can be logged in through SSH key only (password access is disabled) from dedicated access server 'jump.sipwise.com' only.

To completely remove Sipwise access to your system, please execute as user root:

```
root@myserver:~# ngcp-support-access --disable && apt-get install ngcp-support-noaccess
```

**NOTE** | you have to execute the command above on each node of your Sipwise C5 system!

**WARNING** | please ensure that the script complete successfully:

```
* Support access successfully disabled.
```

If you need to restore Sipwise access to the system, please execute as user root:

```
root@myserver:~# apt-get install ngcp-support-access && ngcp-support-access --enable
```

**WARNING** | please ensure that the script complete successfully:

```
* Support access successfully enabled.
```

### 13.1.1. Secure system and user SSH keys

The Sipwise C5 defaults to generating and using internally secure SSH system and user keys.

That does not cover user installed keys, or systems that have been upgraded from previous defaults.

Because system and user SSH keys cannot easily be deprecated without remote user involvement, this is a process that is not performed automatically during upgrade. Instead there is a 'ngcp-check-ssh-keys' command that will perform various checks on the system, and report either errors or warnings for the issues it detects. Its manual page documents these issues and the general procedures to follow to resolve them.

## 13.2. Firewalling

### 13.2.1. Firewall framework

The Sipwise C5 runs a wide range of services. In order to secure the platform while allowing access to Sipwise C5, Sipwise C5 configuration framework provides a set of predefined network zones. Services are aggregated into appropriate zones by default. Zones are assigned to network interfaces (and VLANs if applicable) in `/etc/ngcp-config/network.yml`.

#### CAUTION

Though the default firewall setup provided by Sipwise C5 configuration framework provides a safe setup for Sipwise C5, security audits of the platform performed by qualified engineers before commissioning the platform into service are strongly recommended. Customization of the setup requires in-depth knowledge of firewalling principles in general and the 'netfilter' facility in particular.

Table 41. Sipwise C5 network zones

Zone name	Description
ha_int	Internal HA (High Availability) communication interface between the services
mon_ext	Interface to connect external monitoring appliances (SNMP)
rtp_ext	Interface for external RTP media relay between Sipwise C5 and endpoints (e.g. user agents, peers)
sip_ext	Interface for external SIP signalling between Sipwise C5 and endpoints (e.g. user agents, peers)
sip_int	Interface for internal signalling, e.g. between load-balancers, proxies and applications servers
ssh_ext	Interface providing external access to Sipwise C5 command line interface
ssh_int	Interface providing internal access to Sipwise C5 command line interface (necessary for ngcp-installer)
web_ext	Interface providing access to the customers' self-care Web panel
web_int	Interface for access to the administrative Web panel, its REST APIs and internal API communications

#### NOTE

Additional custom zones may be configured, but will not be automatically integrated into the firewall configuration.

To facilitate firewall functionality, Sipwise C5 uses the Kernel's 'netfilter' facility and 'iptables-persistent' as an interface to 'netfilter'. 'Netfilter' is using 'tables' and within that 'chains' to store rules in this hierarchy: 'table' 'chain' 'rule'. Default firewall setups of Sipwise C5 do not use netfilter tables 'nat' and 'raw', but only default table 'filter'.

#### NOTE

Custom 'nat' rules for IPv4 and IPv6 may be added in file `/etc/ngcp-config/config.yml` in sections 'securityfirewallnat\_rules4' and 'securityfirewallnat\_rules6'.

Each 'chain' deploys a 'default policy' handling packets which did not trigger any rule in a particular

'chain'.

Table 42. Sipwise C5 'netfilter' default policies

Chain	Default policy	Description
INPUT	DROP	Handling all packets directly destined for a Sipwise C5 node (only packets matching a rule are allowed)
FORWARD	DROP	Handling all packets received by a Sipwise C5 node and destined for another, non-local IP destination (no default rules added)
OUTPUT	ACCEPT	Handling all packets originating on a Sipwise C5 node (no default rules added)
rtpengine	N/A	Container for rtpengine rule to allow the rule to persist even when the Kernel module is unloaded (e.g. during upgrades)

The default firewall setup provided by Sipwise C5:

- adds rules to INPUT to allow access to the platform only via specific services
- blocks all traffic from and to FORWARD
- allows all OUTPUT traffic
- allows adding additional rules to further restrict access

### 13.2.2. Sipwise C5 firewall configuration

The Sipwise C5 comes with a preconfigured set of firewall rules, which can be enabled and configured in `/etc/ngcp-config/config.yml` in section `security->firewall`. Refer to [security](#) for available configuration options.

Firewall configuration is applied by running `ngcpcfg apply`. However, this will not activate new rules automatically to avoid inadvertent self-lockout. To finally activate new firewall rules run `ngcp-iptables-apply`. This will prompt for another system logon to verify access remains available. If the prompt is not confirmed, firewall rules will automatically be reverted to the previous state re-enabling access to the command line.

#### IMPORTANT

`ngcp-iptables-apply` needs to be enforced on each active and standby Sipwise C5 node providing the 'mgmt', 'lb', or 'rtp' roles (Please, refer to [Available Host Options](#) for further details). Additionally, any changes made into firewall rules will require to execute this command again on the corresponding nodes.

#### CAUTION

The Sipwise C5 firewall subsystem by default is disabled in `'/etc/ngcp-config/config.yml'` key `security.firewall.enable: no`. This is to avoid blocking any traffic inadvertently during installation. After the firewall subsystem has been configured appropriately, it needs to be enabled by setting `security.firewall.enable: yes` in `'/etc/ngcp-config/config.yml'`.

### 13.2.3. System rules

The following set of rules is added by the system upon activation of the firewall subsystem. Individual system rules are configured in '/etc/ngcp-config/templates/etc/iptables/rules.v4.tt2' and '/etc/ngcp-config/templates/etc/iptables/rules.v6.tt2'

Table 43. Firewall system rules

Zone	Chain	Target	Rule	Description
n/a	INPUT	ACCEPT	-i lo -j ACCEPT	Accept all packets received by local loopback interface
n/a	OUTPUT	ACCEPT	-o lo -j ACCEPT	Accept all packets sent over local loopback interface
n/a	INPUT (IPv4)	DROP	! -i lo -s 127.0.0.0/8 -j DROP	Ignore all packets received on an external interface claiming to be from the loopback interface
n/a	INPUT (IPv6)	DROP	! -i lo -s ::1/128 -j DROP	Ignore all packets received on an external interface claiming to be from the loopback interface
all	INPUT	ACCEPT	-m state --state RELATED,ESTABLISHED -j ACCEPT	Accept all incoming packets tied to 'related' or 'established' connections
all	INPUT (IPv4)	ACCEPT	-p icmp -m icmp --icmp-type 8 -j ACCEPT	Accept all ICMP 'echo' messages
all	INPUT (IPv4)	ACCEPT	-p icmp -m icmp --icmp-type 0 -j ACCEPT	Accept all ICMP 'echo reply' messages
all	INPUT (IPv6)	ACCEPT	-A INPUT -p ipv6-icmp -j ACCEPT	Accept all ICMPv6 messages
all	ngcp_cluster	ACCEPT	-s '<node_ip>' -j ACCEPT	Set of rules white-listing all IP-addresses owned by Sipwise C5 platform for incoming traffic
ssh_ext	ngcp_ssh_ext	ACCEPT	-A ngcp_ssh_ext -s '<sshd.permit_support_from>' -j ACCEPT	List of rules to accept incoming packets for SSH on all 'ssh_ext' interfaces from hosts configured in '/etc/ngcp-config/config.yml' with key 'sshd.permit_support_from'
mon_ext	ngcp_mon_ext	ACCEPT	-A ngcp_mon_ext -s '<snmpclient_ip>' -j ACCEPT	Set of rules for all 'mon_ext' interfaces based on a list of IPs for all SNMP communities configured in 'snmpd.communities'

Zone	Chain	Target	Rule	Description
'ZONE'	ngcp_'ZONE' E'	ACCEPT	-A ngcp_'ZONE' -j ACCEPT	Default permissive allow rule for each remaining zone
all	INPUT	ngcp_clust er	-j ngcp_cluster	Divert all incoming packets to the 'cluster' chain
mon_ext	INPUT	ngcp_mon_ ext	-i 'mon_ext interface' -p udp --dport 161 -j ngcp_mon_ext	Divert SNMP packets to the 'mon_ext' chain
ssh_ext	INPUT	ngcp_ssh_ ext	-i 'ssh_ext interface' -p tcp --dport 'sshd.port' -j ngcp_ssh_ext	Divert connection requests to the SSH service to the 'ssh_ext' chain
web_ext	INPUT	ngcp_web_ ext	-i 'web_ext interface' -p tcp --dport '<www_admin.http_csc.port>' -j ngcp_web_ext	Divert connection requests to the customer self-care HTTPS service to the 'web_ext' chain
web_ext	INPUT	ngcp_web_ ext	-i 'web_ext interface' -p tcp --dport '<autoprov.server.port>' -j ngcp_web_ext	Divert connection requests to the device auto-provisioning service to the 'web_ext' chain
web_ext	INPUT	ngcp_web_ ext	-i 'web_ext interface' -p tcp --dport '<autoprov.server.bootstrap_po rt>' -j ngcp_web_ext	Divert connection requests to the device bootstrapping service to the 'web_ext' chain
web_int	INPUT	ngcp_web_ int	-i 'web_int interface' -p tcp --dport '<www_admin.http_admin.port >' -j ngcp_web_int	Divert connection requests to the platform administration HTTPS service to the 'web_int' chain
sip_ext	INPUT	ngcp_sip_ ext	-i 'sip_ext interface' -p udp --dport '<kamailio.lb.port>' -j ngcp_sip_ext	Divert UDP packets sent to the SIP load balancer to the 'sip_ext' chain
sip_ext	INPUT	ngcp_sip_ ext	-i 'sip_ext interface' -p tcp --dport '<kamailio.lb.port>' -j ngcp_sip_ext	Divert connection requests to the TCP SIP load balancer to the 'sip_ext' chain
sip_ext	INPUT	ngcp_sip_ ext	-i 'sip_ext interface' -p tcp --dport '<kamailio.lb.tls.port>' -j ngcp_sip_ext	Divert connection requests to the TCP/TLS SIP load balancer to the 'sip_ext' chain
sip_ext	INPUT	ngcp_sip_ ext	-i 'sip_ext interface' -p tcp --dport '<pushd.port>' -j ngcp_sip_ext	Divert connection requests to mobile push service to the 'sip_ext' chain
api_int	INPUT	ngcp_api_ int	-i 'api_int interface' -p tcp --dport '<ossbss.port>' -j ngcp_api_int	Divert connection requests to internal API service to the 'api_int' chain
rtp_ext	INPUT	ngcp_rtp_ ext	-i 'rtp_ext interface' -p udp --dport '<rtpengine.minport>':'<rtpengin e.maxport>' -j ngcp_rtp_ext	Divert external RTP and RTCP to the 'rtp_ext' chain

Zone	Chain	Target	Rule	Description
rtp_int	INPUT	ngcp_rtp_int	-i 'rtp_int interface' -p udp --dport '<rtpengine.minport>':'<rtpengine.maxport>' -j ngcp_rtp_int	Divert internal RTP and RTCP to the 'rtp_int' chain

**CAUTION**

To function correctly, the *rtpengine* requires an additional *iptables* rule installed. This rule (with a target of *rtpengine* along with a chain called *rtpengine*) is automatically installed and removed when the *rtpengine* starts and stops, so normally you don't need to worry about it. However, any 3rd party firewall solution can potentially flush out all existing *iptables* rules before installing its own, which would leave the system without the required *rtpengine* rule and this would lead to decreased performance. It is imperative that any 3rd party firewall solution either leaves this rule untouched, or installs it back into place after flushing all rules out. As the required rule may not clearly be visible when listing the currently installed rules (either via *iptables* or via *nft*), the command (run as root or under *sudo*) *rtpengine --nftables-status* can be used to confirm that the required rules are correctly installed. These rules can be manipulated (installed or removed) as needed via the commands *rtpengine --nftables-start* and *rtpengine --nftables-stop* respectively. The *rtpengine* service itself does not need to be restarted in order to do this.

**NOTE**

Some of the parameters used to populate the firewall rules automatically may contain hostnames instead of IP addresses. Since firewall rules need to be configured based on IP addresses by design, Sipwise C5 configuration framework will lookup such hostnames during 'ngcpcfg apply' and expand them to the IP addresses as returned by 'gethostbyname'. If DNS resolving changes for such hostnames due to changes to DNS the rules will not update automatically. Another run of 'ngcpcfg apply' will be needed to re-perform the lookup and update the rules to reflect changes in DNS. If this step is omitted, clients may be locked out of the system.

**NOTE**

By default, the rules for the 'rtp\_ext' zone are created with a target of ACCEPT. It is optionally possible to create these rules with another *iptables* chain as target, and instruct the RTP proxy to dynamically manage individual rules for each running call in this chain. If this is enabled, the chain with the name given in the `/etc/ngcp-config/config.yml` key `rtpengine->firewall_iptables_chain` will be created as empty, leaving the effective target for UDP packets within the RTP port range as the table's default policy (normally DROP). The RTP proxy will then dynamically create one ACCEPT rule for each open RTP media port in the given chain when a call starts, and delete it when the call is finished. It should be noted that dynamically creating and deleting *iptables* rules can incur a significant performance overhead, especially in scenarios with high call volumes, and it is therefore not recommended to enable this feature in such cases.

### 13.2.4. Custom rules

The Sipwise C5 configuration framework makes it possible to add custom rules to the firewall setup in `/etc/ngcp-config/config.yml`. Custom rules can be added in a variety of ways, depending on the intended use and purpose.

Each zone described above corresponds to a set of sections in the YAML file (one for IPv4, one for IPv6), with each section containing a list of rules applicable to that zone. By default, each zone contains a

single, permissive, catch-all ACCEPT rule to ensure that enabled services work out of the box, with the exception of the `ssh_ext` and `mon_ext` zones, which are restricted by default.

For example, the list of rules applicable to IPv4 RTP sent to any `rtp_ext` interface can be found as:

```
security:
  firewall:
    services:
      rtp_ext:
        rules4:
          - -j ACCEPT
```

This list can be extended to either disallow specific sets of traffic and allow everything else for that service (a list of specific DROP rules followed by a catch-all ACCEPT), or allow only a specific set of traffic and disallow everything else (a list of specific ALLOW rules followed by a catch-all DROP).

Rules are in free-form iptables syntax, but must not include the insert operation (`-A` or `-I`) nor the name of the respective chain.

For example, to allow external SIP only from a list of certain IP networks:

```
security:
  firewall:
    services:
      sip_ext:
        rules4:
          - -s 198.51.100.0/24 -j ACCEPT
          - -s 233.252.0.0/24 -j ACCEPT
          - -j DROP
        rules6:
          - -s 2001:db8:123:abc::/64 -j ACCEPT
          - -j DROP
```

#### NOTE

Depending on the "default policy" set for the INPUT chain (see above), the final catch-all ALLOW or DROP rule may be omitted.

Input filter rules that don't correspond to one of the pre-defined zones can be added in one of the `security.firewall.input_rules...` lists. `input_rules4...` applies to IPv4 and `input_rules6...` applies to IPv6. These lists come in two varieties: The rules from the `_pre` list are inserted **before** the system-defined rules corresponding to network zones, while the rules from the `_post` list are inserted **after** the system-defined rules. As such, in a normal firewall setup the `_pre` list is mostly useful to restrict things that otherwise would be allowed, while the `_post` list is mostly useful to allow things that otherwise would be restricted.

Additional rules that apply to one of the other iptables chains or tables (the `nat` table, or a filter chain that isn't INPUT) can be added in the `nat_rules` and `filter_rules` lists respectively. Unlike the other lists or rules, these lists use the full iptables syntax, i.e. they must include the insert operation (normally `-A` for "append") and the chain name (such as FORWARD or the name of a custom chain).

Custom chains can be created as needed by adding them to the `custom_chains` list. These chains can

be populated through rules in `filter_rules` or `nat_rules`, and can be referred to as a jump target from any other rule (`-j` + the name of the custom chain). This can be useful to create sets of rules that can be applied to multiple zones (e.g. a shared set of allowed addresses).

Example custom rule to allow-list all IPv4 traffic from network interface `eth1.301`, effectively making VLAN 301 a trusted network:

```
security:
  firewall:
    input_rules4_post:
      - -i eth1.301 -j ACCEPT
```

Example custom rule to accept incoming traffic from monitoring station `203.0.113.93` for an optionally installed `check_mk` agent:

```
security:
  firewall:
    input_rules4_post:
      - -p tcp -s 203.0.113.93 --dport 6556 -j ACCEPT
```

To add hosts or networks to the SSH allow-list, they can be either added to key `'sshd.permit_support_from'` in `'/etc/ngcp-config/config.yml'` or they can be added to list for the appropriate zone:

```
security:
  firewall:
    services:
      ssh_ext:
        rules4:
          - -s 198.51.100.0/24 -j ACCEPT
          - -s 203.0.113.93 -j ACCEPT
```

#### NOTE

In custom rules keys from `'/etc/ngcp-config/config.yml'` cannot be referenced. Thus, the values need to be manually looked up, hard coded, and kept in sync manually. This is by design of YAML.

### 13.2.5. Example firewall configuration section

An example for Sipwise C5 firewall configuration in `'/etc/ngcp-config/config.yml'`, enabling both the firewall subsystem and the logging facility, and adding a custom chain to allow administration (SSH and HTTPS admin panel) only from a single address, may look like:

```
security:
  firewall:
    custom_chains:
      - admins
    enable: yes
```

```
filter_rules4:
  - -A admins -s 198.51.100.42 -j ACCEPT
  - -A admins -j DROP
filter_rules6:
  - -A admins -j DROP
input_rules4_post: []
input_rules4_pre: []
input_rules6_post: []
input_rules6_pre: []
logging:
  days_kept: '7'
  enable: yes
  file: /var/log/firewall.log
  tag: NGCPFW
nat_rules4: []
nat_rules6: []
policies:
  forward: DROP
  input: DROP
  output: ACCEPT
services:
  api_int:
    rules4:
      - -j ACCEPT
    rules6:
      - -j ACCEPT
  mon_ext:
    rules4: []
    rules6: []
  rtp_ext:
    rules4:
      - -j ACCEPT
    rules6:
      - -j ACCEPT
  rtp_int:
    rules4:
      - -j ACCEPT
    rules6:
      - -j ACCEPT
  sip_ext:
    rules4:
      - -j ACCEPT
    rules6:
      - -j ACCEPT
  sip_int:
    rules4:
      - -j ACCEPT
    rules6:
      - -j ACCEPT
  ssh_ext:
    rules4:
      - -j admins
```

```
rules6:
- -j admins
web_ext:
rules4:
- -j ACCEPT
rules6:
- -j ACCEPT
web_int:
rules4:
- -j admins
rules6:
- -j admins
```

## 13.3. Password management

The Sipwise C5 comes with some default passwords the user should change during the deployment of the system. They have been explained in the previous chapters of this handbook.

### IMPORTANT

Many Sipwise C5 services use MySQL backend. Users and passwords for these services are created during the installation. These passwords are unique for each installation, and the connections are restricted to localhost. You should not change these users and passwords.

### 13.3.1. The "root" account

The Sipwise C5's super-user account comes with a preconfigured password. It is imperative that this password is changed by the operator immediately after Sipwise C5 is shipped and before it is connected to any potentially unsecure public or private network using a secure password in compliance with existing password policies of the operator. The "root" password must not be shared outside of the operator's organization including Sipwise engineers. The "root" password must not be shared in any publicly accessible communications including e-mail or ticketing systems.

To change the root password log into the freshly deployed system as "root" using the preconfigured password and execute:

```
root@myserver:~# passwd
```

Then follow the prompts to change the password.

### 13.3.2. The "administrator" account

The Sipwise C5 Web-interface comes with a preconfigured "administrator" account deployed with a default password. This account can be considered Sipwise C5 application super-user and has far-reaching access to application specific settings via the Web-interface. It is imperative that the password for this account is changed by the operator immediately after Sipwise C5 is shipped and before it is connected to any potentially unsecure public or private network using a secure password in compliance with existing password policies of the operator. The "administrator" password must not be shared outside of the operator's organization including Sipwise engineers. The "administrator" password must not be shared in any publicly accessible communications including e-mail or ticketing systems.

The password for the "administrator" account can be changed via the Web-interface.

### 13.3.3. The "cdreexport" account

The login for the system account *cdreexport* is disabled by default. Although this is a jailed account, it has access to sensitive information, namely the Call Detail Records of all calls. SSH keys should be used to login this user, or alternatively a really strong password should be used when setting the password via `passwd cdreexport`.

### 13.3.4. The MySQL "root" user

The *root* user in MySQL has no default password. A password should be set using the `mysqladmin password` command.

### 13.3.5. The "ngcpsoap" account

Generate new password for user *ngcpsoap* to access the provisioning interfaces, see the details in [REST API](#).

## 13.4. UI/API security

The UI/API security configuration is located in `config.yml` as:

```
www_admin:
  security:
    jwt:
      expires: 36000
    login:
      ban_enable: yes
      ban_increment: 300
      ban_max_time: 3600
      ban_min_time: 300
      max_attempts: 5
    password:
      allow_recovery: '0'
      max_length: 40
      min_length: 12
      musthave_digit: 3
      musthave_lowercase: 3
      musthave_specialchar: 3
      musthave_uppercase: 3
      sip_autogenerate: '0'
      sip_expose_subadmin: '1'
      sip_keep_last_used: 12
      sip_validate: no
      web_autogenerate: '0'
      web_expose_subadmin: '1'
      web_keep_last_used: 12
      web_max_age_days: 0
      web_validate: no
```

### 13.4.1. Authentication security

There is a progressive ban system in place (enabled by default) that upon unsuccessful 'max\_attempts' logins bans the user on UI/API (that includes JWT) for 'ban\_min\_time + ban\_progression\_stage \* ban\_increment'. \* 'ban\_progression\_state' is 0 by default and increments by 1 every time the user is banned, and resets back to 0 upon successful login. 'ban\_max\_time' is the absolute max ban time that will not be exceeded by the progression. \* when a user is banned the UI does not return any specific indication that the user is banned and API returns 401 Unauthorized as per invalid credentials. \* bans are per User+Domain+IP address.

### 13.4.2. Password validation

With password validation enabled via 'sip\_validate = yes' (SIP passwords) or 'web\_validate = yes' (UI/API passwords for admin and subscriber users), every time a password insert/update attempt is validated for the following states:

- password strength, the score is calculated based on multiple factors and passwords with low score (aka: weak passwords) are not allowed.
- by default the password must be 12-40 length and contain at least 3 of lower-case characters, upper-case characters, digits and special chars combined (corresponding to the config options: 'min\_length', 'max\_length', 'musthave\_lowercase', 'musthave\_uppercase', 'musthave\_digit', 'musthave\_specialchar').
- password cannot match the username.
- it cannot be one of last used passwords, corresponding to 'sip\_keep\_last\_used' (for SIP passwords) and 'web\_keep\_last\_used' (for admin and subscriber passwords).

When one of the password validation options (e.g. 'musthave\_digit') is set to 0 - it is considered as disabled.

### 13.4.3. Max Password Age (Password Expiration)

'web\_max\_age\_days' (default: 0) can be used to enable password expiration for admin and subscriber users. When set to anything greater than 0 and the password expires - the following behaviour happens for the user:

- logged in UI users are automatically redirected to the "Password Change" page, where after successful password change they are redirected back to their previous page.
- UI users who log in with the expired password are redirected to the "Password Change" page and afterwards to the default page (dashboard).
- all API v1 requests return 403 Forbidden "Password expired" except PUT/PATCH operations towards /api/admins or /api/subscribers for the authenticated user that contain a new password.

## 13.5. Managing POSIX users

The interface to create and delete system or non-system users from the command-line is provided by the 'adduser' package. This package contains the 'adduser', 'deluser', 'addgroup' and 'delgroup' programs that will apply the system policy on ID allocation ranges, home permissions, and any other security parameter.

**NOTE**

Directly using the 'useradd', 'userdel', 'groupadd' and 'groupdel' programs can cause unexpected behavior, such as too permissive home directories. This does not apply to the other programs from the same 'passwd' package to manage POSIX users, such as 'usermod', 'groupmod', 'chfn' and other similar programs.

## 13.6. LDAP authentication for POSIX users

The Sipwise C5 can be configured to accept LDAP authentication for POSIX users. This applies to both local console and remote SSH access.

The LDAP authentication is done through SSSD, a component that abstracts remote account management and handles caching to cope with remote system connectivity issues.

To enable this authentication method, the 'sssd.enable' option needs to be set to 'yes', and the LDAP host needs to be specified in 'sssd ldap.host'. And finally, the LDAP base DN to use for searches needs to be specified in 'sssd ldap.base\_dn'.

**NOTE**

The LDAP host must be accessed via LDAPS (LDAP over TLS), as this is required for authentication requests. Using unencrypted LDAP will not work. The TLS connection is assumed to involve a trusted certificate, otherwise self-signed certificates would need to be placed on the system CA certificates store.

Depending on the layout of the LDAP accounts the 'sssd ldap.access\_filter' might need to be changed from the default, for example to allow for group based access controls.

**NOTE**

By default on the Sipwise C5, 'su' requires users to be on the 'wheel' group to be able to use it at all. If the account on LDAP is not part of such group, then these users will be unable to use 'su'.

## 13.7. Remote 'root' logins via SSH

To mitigate possible system intrusions from the outside, it is commonly held best practise to disable remote 'root' (administrator) logins. With remote root logins disabled, it's still possible to log into the system via SSH to a regular, non-privileged user account, and then use 'sudo' or 'su' to elevate account privileges to 'root' administrator level.

**WARNING**

For system setup purposes, the default setting on the Sipwise C5 is to permit remote 'root' logins via SSH. It is strongly recommended to change this default setting as soon as possible.

Once you've created a user account for yourself that can be used to gain 'root' privileges, remote 'root' logins can be disabled via the config switch `sshdpermit_root_login` in `/etc/ngcp-config/config.yml`.

```
sshd:  
  permit_root_login: yes
```

Valid options are:

- 'yes' - permit remote root logins via SSH. Not recommended.
- 'no' - prohibit all remote root logins via SSH.

- 'prohibit-password' - permit remote root logins, except when password authentication is used. This is a good setting if you still wish to access the 'root' account directly using public-key authentication, but also want to prohibit remote brute-force attacks against the 'root' account password.
- 'forced-commands-only' - identical to 'prohibit-password' but with the additional restriction that only SSH config sections that have a forced command (via *command=* or *ForceCommand*) are permitted to log in. For advanced users.

If either 'no' or 'forced-commands-only' is chosen, the Sipwise C5 will generate special SSH config sections that still allow root logins (using 'prohibit-password') from IP addresses that are internal to the Sipwise C5. This is necessary to ensure that the scripts handling the Sipwise C5 config framework continue to function and does not compromise security.

## 13.8. 'sudo-io': logging input/output of commands run through 'sudo'

It is possible to enable logging for the input and output of commands run through 'sudo', along other meta-information like timing, to be able to reproduce sessions.

The logs are saved in directories with a special structure, the numbers are for a so-called "session" or sequence:

```
$BASE_DIR/$USERNAME/00/00/00
```

For example:

```
/var/log/sudo-io/root/00/00/00
```

and within them, several files for tty input and output, stdin/stdout/stderr, and other ancillary files.

New session use 00/00/01, 00/00/02 and so on.

This is disabled by default, but can be configured in */etc/ngcp-config/config.yml* with the following options:

```
sudo:
  logging:
    enable: no
    exclude_users: []
    max_sessions: 0
```

Valid options are:

- 'enable': 'no' (default) or 'yes'; to use the feature or not
- 'exclude\_users': list of users whose commands are excluded from logging
- 'max\_sessions': 0 by default, which means unlimited. If set to a positive integer, the sequence

returns to 0 after reaching it, and starts to overwrite the files in the subdir '00/00/00' instead of increasing indefinitely.

**WARNING**

This sudo plugin saves all input and output including passwords typed in shell prompts (even when they are not echoed to the screen), and this is unencrypted, so please consider the security implications.

**WARNING**

Even if in some versions the compression of these files is enabled, some commands can use huge amounts of data and fill-up the available disk space very quickly, and full disk will cause serious problems (failures in services, or even preventing external access to the system to fix the problems). Please consider setting up monitoring of free space, or mitigating measures like setting a small amount of sessions saved, taking data out the system often for preservation and deleting sessions from previous days, etc.

**WARNING**

Additionally, this has a performance impact (both CPU and I/O) on every command run with sudo that triggers logging, negligible for most commands but significant when the input or output is large.

## 13.9. SSL certificates

The Sipwise C5 provides default, self-signed SSL certificates for SSL connections. These certificates are common for every installation. Before going to production state, the system administrator should provide SSL certificates for the web services. These certificates can either be shared by all web interfaces (*provisioning*, *administrator interface* and *customer self care interface*), or separate ones for each them can be used.

- Generate the certificates. The *customer self care interface* certificate should be signed by a certification authority to avoid browser warnings.
- Upload the certificates to the system
- Set the path to the new certificates in `/etc/ngcp-config/config.yml`:
  - `ossbssapacheautoprovsslcertfile` and `ossbssapacheautoprovsslcertkeyfile` for the *provisioning interface*.
  - `ossbssapacherestapisslcertfile` and `ossbssapacherestapisslcertkeyfile` for the *REST interface*.
  - `www_adminhttp_adminsslcertfile` and `www_adminhttp_adminsslcertkeyfile` for the *admin interface*.
  - `www_adminhttp_cscsslcertfile` and `www_adminhttp_cscsslcertkeyfile` for the *customer self care interface*.
- Apply the configuration changes with `ngcpcfg apply 'added web ssl certs'`.

The Sipwise C5 also provides the self-signed SSL certificates for SIP over TLS services. The system administrator should replace them with certificates signed by a trusted certificate authority if he is going to enable it for the production usage (config.yml section: *kamailiolbtl*s (TLS is enabled by default and uses self-signed SSL certificates)).

- Generate the certificates.
- Upload the certificates to the system
- Set the path to the new certificates in `/etc/ngcp-config/config.yml`:

`kamailio/btldsdomains<domain>sslcertfile` and `kamailio/btldsdomains<domain>sslcertkeyfile` .

- Apply the configuration changes with `ngcpcfg apply 'added kamailio certs'`.

## 13.10. Securing your Sipwise C5 against SIP attacks

The Sipwise C5 allows you to protect your VoIP system against SIP attacks, in particular **Denial of Service** and **brute-force attacks**. Let's go through each of those attacks and let's see how to configure your system in order to face such situations and react against them.

### 13.10.1. Denial of Service

As soon as you have packets arriving on your Sipwise C5 server, it will require a bit of time of your CPU. Denial of Service attacks are aimed to break down your system by sending floods of SIP messages in a very short period of time and keep your system busy to handle such huge amount of requests. Sipwise C5 allows you to block such kind of attacks quite easily, by configuring the following section in your `/etc/ngcp-config/config.yml` :

```
kamailio:
  lb:
    security:
      dos_ban_enable: yes
      dos_ban_time: 3600
      dos_reqs_density_per_unit: 50
      dos_sampling_time_unit: 2
      dos_whitelisted_ips: []
      dos_whitelisted_subnets: []
```

As soon as Sipwise C5 receives more than 50 messages from the same IP in a time window of 2 seconds, that IP will be blocked for 3600 sec, and you will see in the `kamailio-lb.log` a line saying:

```
Nov 9 00:11:53 sp1 lb[41958]: WARNING: <script>: IP '203.0.113.42' is
blocked and banned - R=<null> ID=304153-3624477113-
19168@tedadg.testlab.local
```

The banned IP will be stored in kamailio memory, you can check the list via web interface or via the following command:

```
# ngcp-kamctl lb fifo htable.dump ipban
```

#### IMPORTANT

On CARRIER systems, this command must be executed on the **active** load balancer node.

### Excluding SIP endpoints from banning

There may be some SIP endpoints that send a huge traffic towards Sipwise C5 from a specific IP address. A typical example is a *SIP Peering Server*.

**CAUTION**

Sipwise C5 supports handling such situations by excluding all defined *SIP Peering Servers* from DoS protection mechanism.

The Sipwise C5 platform administrator may also add whitelisted IP addresses manually in `/etc/ngcp-config/config.yml` at `kamailio.lb.security.dos_whitelisted_ips` and `kamailio.lb.security.dos_whitelisted_subnets` parameters.

**13.10.2. Bruteforcing SIP credentials**

This is a very common attack that can be checked via the `/var/log/ngcp/kamailio-proxy.log` file. There will be INVITE/REGISTER messages coming in with strange usernames. Attackers are trying to spoof/guess subscriber's credentials, which allow them to call out. The very first protection against these attacks is: **ALWAYS USE STRONG PASSWORD**. Nevertheless, Sipwise C5 allows you to detect and block such attacks quite easily by configuring one or both the following methods in `/etc/ngcp-config/config.yml` file

**Subscriber ban**

This is the most used method and allows to block a subscriber after a predefined number of failed authentication attempts. The disadvantage of this type of ban is that an attacker can easily block any legitimate subscriber just knowing its username.

```
kamailio:
  lb:
    security:
      failed_auth_attempts: 3
      failed_auth_ban_enable: yes
      failed_auth_ban_time: 3600
```

It may be required to increase the number of failed attempts by adjusting the ban time (e.g. some users can be banned accidentally because they are not writing the right password). If a user tries to authenticate an INVITE/REGISTER (or more in general, any request containing an *Authorization* or *Proxy-Authorization* SIP header) and if it fails more than 3 times, the `user@domain` will be blocked for 3600 seconds (see `failed_auth_ban_time` on `/etc/ngcp-config/config.yml`). In this case, you will see the following lines in `/var/log/ngcp/kamailio-lb.log` file:

```
Nov 9 13:31:56 sp1 lb[41952]: WARNING: <script>: Consecutive
Authentication Failure for 'sipvicous@mydomain.com' UA='sipvicous-
client' IP='203.0.113.42' - R=<null> ID=313793-3624525116-
589163@testlab.local
```

**13.10.3. IP ban**

This type of ban is similar to the previous one but the IP address of the source user is blocked in case of excessive failed authentication attempts. This method blocks the IP even if the failed attempts are done using different subscribers usernames.

```
kamailio:
```

```
lb:
  security:
    failed_ip_auth_attempts: 3
    failed_ip_auth_ban_enable: yes
    failed_ip_auth_ban_time: 3600
```

It may be required to increase the number of failed attempts by adjusting the ban time (e.g. some users can be banned accidentally because they are not writing the right password). If a user tries to authenticate an INVITE/REGISTER (or more in general, any request containing an *Authorization* or *Proxy-Authorization* SIP header) and if it fails more than 3 times, the *IP* will be blocked for 3600 seconds (see *failed\_ip\_auth\_ban\_time* on */etc/ngcp-config/config.yml*). In this case, you will see the following lines in */var/log/ngcp/kamailio-lb.log* file:

```
Nov 9 13:31:56 sp1 lb[41952]: WARNING: <script>: Consecutive IP
Authentication Failure for 'sipvicous@mydomain.com' UA='sipvicous-
client' IP='203.0.113.42' - R=<null> ID=313793-3624525116-
589163@testlab.local
```

Both the banned IPs and banned users will be shown in the Admin web interface by accessing the *SettingsSecurity Bans* menu. To retrieve the same information from *Kamailio* memory, use the following command:

```
# ngcp-kamctl lb fifo htable.dump auth
```

### IMPORTANT

On CARRIER systems, this command must be executed on the **active** load balancer node.

```
# ngcp-kamctl lb fifo htable.dump ip_auth
```

### IMPORTANT

On CARRIER systems, this command must be executed on the **active** load balancer node.

## 13.11. Topology Hiding

### 13.11.1. Introduction to Topology Hiding on NGCP

The term "topology hiding" in SIP is used to describe the measures taken by typically an SBC (Session Border Controller) to hide detailed information of the internal network at the border of which it is located. Pieces of information such as IP addresses and port numbers used by SIP endpoints and intermediaries within the network are considered sensitive, as these can give some hints to potential attackers about the topology of the network.

In a typical SIP session the mandatory headers may carry that sensitive information, for example: *Contact*, *Via*, *Record-Route*, *To*, *From*, *Call-ID*. An SBC applying topology hiding will mangle the content of those headers.

### 13.11.2. Topology Masking Mechanism

Concealment of sensitive information using this mechanism is achieved through encoding the original content of selected SIP headers. Then Sipwise C5 will create a new SIP URI using a preselected IP address and the encoded content as URI parameter, finally re-assembling the SIP header.

Examples for encoded SIP headers:

```
Record-Route: <sip:127.0.0.8;line=sr-NvaAlWtecghucEhu6WtAcu...>
Contact: <sip:127.0.0.8;line=sr-NvaAli-1VeL.kRxLcbN86W...>
```

The *load-balancer* element of Sipwise C5 has an SBC role, from the SIP peers point of view. The *LB* offers topology masking function that can be activated through a configuration change. By default the function is disabled.

#### IMPORTANT

Topology masking is not applied to outbound REGISTER message. It also excludes OPTIONS message to avoid overloading in case of natping high traffic. You can exclude additional SIP messages using the config.yml section `kamailio.lb.security.topos.exclude`.

### Configuration of Topology Masking

Activating topology masking function is possible through the modification of the following configuration parameters in `/etc/ngcp-config/config.yml` file (shown below with default values of parameters):

```
kamailio:
  lb:
    security:
      topoh:
        enable: no
        mask_callid: no
        mask_ip: 127.0.0.8
```

Meaning of the configuration parameters:

- `enable`: if set to **yes**, the topology mask will be activated
- `mask_callid`: if set to **yes**, the SIP Call-ID header will also be encoded
- `mask_ip`: an IP address that will be used to create valid SIP URIs, after encoding the real/original header content.

#### TIP

Any valid, preferably private network address can be used. The suggestion is however to use an address that is not used by any other SIP endpoint or intermediary element in the network.

### Considerations for Topology Masking

Although masking sensitive information about a VoIP provider's network is desired, there are some potential side effects caused by topology masking.

The most common example is the consequence that **SIP message size may grow** when applying topology masking. The fact that SIP messages become larger may even prevent Sipwise C5 from communicating successfully with another SIP entity (a peer SBC, for example). This can be expected under following circumstances:

- SIP transport protocol is UDP
- SIP messages have more *Via and Record-Route* headers
- IP packets of SIP messages without the topology masking feature already have a size close to the MTU

In such a case the IP packets carrying SIP messages with encoded headers will have a size exceeding the MTU, that will cause loss of data in some networks.

The recommended solution in such a case is to use TCP transport for SIP messages.

### 13.11.3. Topology Hiding Mechanism

This mechanism achieves topology hiding by stripping the SIP routing headers that show topology details and storing those data in the associative data structure (hash) in the Redis DB so that it can look it up when a reply or in-dialog SIP message comes in. From the signaling perspective it simulates a SBC (Session Border Controller) on the LB.

#### Considerations for Topology Hiding

This mechanism offers some benefits over the older topology masking approach:

- It enables the Sipwise C5 to interconnect with SIP endpoints that are not capable of operating through a SIP proxy.
- The message size is decreased because of stripping the SIP Record-Route, Route and Via header fields.
- It solves the interoperability issues with SIP ALG in some cases.
- It retains also the lightweight nature and the efficient operation.

The module uses the auto-expiration of the Redis keys so it can cause temporary spikes in the memory usage and redis keys count until produced data is cleaned up by redis.

#### Configuration of Topology Hiding

Activation of the topology hiding function is done through the modification of the following configuration parameters in `/etc/ngcp-config/config.yml` file (shown below with default values of parameters):

```
topos:
  enable: no
  redis_db: 24
```

In order to activate the function, you should set `enable: 'yes'` in `/etc/ngcp-config/config.yml` and leave the Redis DB number unchanged, then execute `ngcpcfg apply "activated topos"`.

## 13.12. System Requirements and Performance

The Sipwise C5 is a very flexible system, capable of serving from hundreds to several tens of thousands of subscribers in a single node. The system comes with a default configuration, capable of serving up to 50.000 subscribers in a *normal* environment. But there is no such thing as a *normal* environment. And Sipwise C5 has sometimes to be tuned for special environments, special hardware requirements or growing traffic.

### NOTE

If you have performance issues with regards to disk I/O please consider enabling the 'noatime' mount option for the root filesystem. Sipwise recommends the usage of 'noatime', though remove it if you use software which conflicts with its presence.

In this section some parameters will be explained to allow Sipwise C5 administrator tune the system requirements for optimum performance.

Table 44. Requirement\_options

Option	Default value	Requirement impact
cleantoolsbinlogs	15	Heavy impact on the harddisk storage needed for mysql logs. It can help to restore the database from backups or restore broken replication.
databasebufferpoolsize	1/2 * Total system RAM	The installer will calculate the total system RAM and dedicate 50% to the mysql innodb buffer. This value won't be changed in case the system RAM changes so it's up to the administrator to adjust it. For test systems or low RAM systems, lowering this setting is one of the most effective ways of releasing RAM. The administrator can check the innodb buffer hit rate on production systems; a hit rate over 99% is desired to avoid bottlenecks.
kamailiolbpkg_mem	16	This setting affects the amount of RAM the system will use. Each kamailio-lb worker will have this amount of RAM reserved. Lowering this setting up to 8 will help to release some memory depending on the number of kamailio-lb workers running. This can be a dangerous setting as the lb process could run out of memory. Use with caution.
kamailiolbshm_mem	1/16 * Total System RAM	The installer will set this value to 1/16 of the total system RAM. This setting does not change even if the system RAM does so it's up to the administrator to tune it. It has been calculated that 1024 (1GB) is a good value for 50K subscriber environment. For a test environment, setting the value to 64 should be enough. "Out of memory" messages in the kamailio log can indicate that this value needs to be raised.
kamailiolbtcp_children	8	Number of TCP workers kamailio-lb will spawn per listening socket. The value should be fine for a mixed UDP-TCP 50K subscriber system. Lowering this setting can free some RAM as the number of kamailio processes would decrease. For a test system or a pure UDP subscriber system 2 is a good value. 1 or 2 TCP workers are always needed.

Option	Default value	Requirement impact
kamailiolbtlsenable	yes	Enable or not TLS signaling on the system. Setting this value to "no" will prevent kamailio to spawn TLS listening workers and free some RAM.
kamailiolbudp_children	8	See <i>kamailiolbtcp_children</i> explanation
kamailiopproxychildren	8	See <i>kamailiolbtcp_children</i> explanation. In this case the proxy only listens udp so these children should be enough to handle all the traffic. It could be set to 2 for test systems to lower the requirements.
kamailiopproxy*_expires		Set the default and the max and min registration interval. The lower it is more REGISTER requests will be handled by the lb and the proxy. It can impact in the network traffic, RAM and CPU usage.
kamailiopproxynatping_interval	30	Interval for the proxy to send a NAT keepalive OPTIONS message to the nated subscriber. If decreased, this setting will increase the number of OPTIONS requests the proxy needs to send and can impact in the network traffic and the number of natping processes the system needs to run. See <i>kamailiopproxynatping_processes</i> explanation.
kamailiopproxynatping_processes	7	Kamailio-proxy will spawn this number of processes to send keepalive OPTIONS to the nated subscribers. Each worker can handle about 250 messages/second (depends on the hardware). Depending the number of nated subscribers and the <i>kamailiopproxynatping_interval</i> parameter the number of workers may need to be adjusted. The number can be calculated like $\text{nated\_subscribers} / \text{natping\_interval} / \text{pings\_per\_second\_per\_process}$ . For the default options, assuming 50K nated subscribers in the system the parameter value would be $50.000 / 30 / 250 = (6,66) 7$ workers. 7 is the maximum number of processes kamailio will accept. Raising this value will cause kamailio not to start.
kamailiopproxysshm_mem	$1/16 * \text{Total System RAM}$	See <i>kamailiolbshm_mem</i> explanation.
rateomatenable	yes	Set this to no if the system shouldn't perform rating on the CDRs. This will save CPU usage.
rsyslogexternal_log	0	If enabled, the system will send the log messages to an external server. Depending on the <i>rsyslogexternal_loglevel</i> parameter this can increase dramatically the network traffic.
rsyslogngcp_logs_preserve_days	93	This setting will set the number of days ngcp logs under <i>/var/log/ngcp</i> will be kept in disk. Lowering this setting will free a high amount of disk space.

**TIP**

In case of using virtualized environment with limited amount of hardware resources, you can use the script *ngcp-toggle-performance-config* to adjust Sipwise C5 configuration for

high/low performance:

```

root@spce:~# /usr/sbin/ngcp-toggle-performance-config
/usr/sbin/ngcp-toggle-performance-config - tool to adjust Sipwise C5
configuration for low/high performance

--help                Display this usage information
--high-performance    Adjust configuration for system with normal/high
performance
--low-performance     Adjust configuration for system with low
performance (e.g. VMs)

root@spce:~#

```

## 13.13. Troubleshooting

The Sipwise C5 platform provides detailed logging and log files for each component included in the system via rsyslog. The main folder for log files is `/var/log/ngcp/`, it contains a list of self explanatory log files named by component name.

The Sipwise C5 is a high performance system which requires compromise between traceability (maximum amount of debug information being written to hard drive) and productivity (minimum load on IO subsystem). This is the reason why different log levels are configured for the provided components by default.

Most log files are designed for debugging Sipwise C5 by Sipwise operational team while main log files for daily routine usage are:

Log file	Content	Estimated size
<code>/var/log/ngcp/api.log</code>	API logs providing type and content of API requests and responses as well as potential errors	medium
<code>/var/log/ngcp/panel.log</code> <code>/var/log/ngcp/panel-debug.log</code>	Admin Web UI logs when performing operational tasks on the ngcp-panel	medium

Log file	Content	Estimated size
/var/log/ngcp/cdr.log	mediation and rating logs, e.g. how many CDRs have been generated and potential errors in case of CDR generation or rating fails for particular accounting data	medium
/var/log/ngcp/ha.log	fail-over related logs in case a node in a pair loses connection to the other side, when a standby node takes over or an active node goes standby due to intra-node communication issues or external ping node connection issues	small

Log file	Content	Estimated size
/var/log/ngcp/kamailio-proxy.log	Overview of SIP requests and replies between lb, proxy and sems processes. It's the main log file for SIP overview	huge
/var/log/ngcp/kamailio-lb.log	Overview of SIP requests and replies along with network source and destination information flowing through the platform	huge
/var/log/ngcp/sems-b2b.log	Overview of SIP requests and replies between lb, proxy and sems processes	small
/var/log/ngcp/rtp.log	rtpengine related log, showing information about RTP communication	small

**WARNING**

it is highly NOT recommended to change default log levels as it can cause system IO overloading which will affect call processing.

**NOTE**

the exact size of log files depend on system type, system load, system health status and system configuration, so cannot be estimated with high precision. Additionally operational network parameters like ASR and ALOC may impact the log files' size significantly.

### 13.13.1. Collecting call information from logs

The easiest way to fetch information about a single call among the log files is the search for the SIP CallID (a unique identifier for a SIP dialog). The call ID is used as call marker in almost all the VoIP related log file, such as `/var/log/ngcp/kamailio-lb.log`, `/var/log/ngcp/kamailio-proxy.log`, `/var/log/ngcp/sems.log`, `/var/log/ngcp/sems-b2b.log` or `/var/log/ngcp/rtp.log`. Example of kamailio-proxy.log line:

```
Nov 19 00:35:56 sp1 proxy[7475]: NOTICE: <script>: New request on proxy
- M=REGISTER R=sip:sipwise.local
F=sip:jdoe@sipwise.local T=sip:jdoe@sipwise.local IP=10.10.1.10:5060
(127.0.0.1:5060) ID=364e4676776621034977934e055d19ea@127.0.0.1 UA='SIP-
UA 203.0.113.42'
```

The above line shows the SIP information you can find in a general line contained in `/var/log/ngcp/kamailio-*`:

- M=REGISTER : The SIP Method
- R=sip:sipwise.local : The SIP Request URI
- F=sip:jdoe@sipwise.local : The SIP From header
- T=sip:jdoe@sipwise.local : The SIP To header
- IP=10.10.1.10:5060 (127.0.0.1:5060) : The source IP where the message is coming from. Between brackets it is shown the local internal IP where the message come from (in this case Load Balancer)
- ID=364e4676776621034977934e055d19ea@127.0.0.1 : The SIP CallID.
- UAIP=10.10.1.10 : The User Agent source IP
- UA='SIP-UA 203.0.113.42' : The SIP User Agent header

In order to collect the full log related to a single call, it's necessary to "grep" the `/var/log/ngcp/kamailio-proxy.log` using the **ID=** string, for example:

```
# grep "364e4676776621034977934e055d19ea@127.0.0.1"
/var/log/ngcp/kamailio-proxy.log
```

### 13.13.2. Collecting SIP traces

The Sipwise C5 platform provides several tools to collect SIP traces. It can be used Sipwise C5 `ngrep-sip` tool to collect SIP traces, for example to fetch traffic in text format from outbound and among load balancer, proxy and sems :

```
# ngrep-sip b
```

see the manual to know all the options:

```
# man ngrep-sip
```

The *ngrep* debian tool can be used in order to make a SIP trace and save it into a *.pcap* file :

```
# ngrep -s0 -Wbyline -d any -0 /tmp/SIP_trace_file_name.pcap port 5062
or port 5060
```

The *sngrep* debian graphic tool as well can be used to visualize SIP trace and save them in a *.pcap* file :

```
# sngrep
```

The Sipwise C5 PRO platform provides also the native VoIP sniffer, called *ngcp-voisniff*, which provide a graphic view of all the calls passing through the platform. It can be enabled via `__/etc/ngcp-config/config.yml`:

```
voisniff:
  admin_panel: yes
  daemon:
    custom_bpf: ''
    enable: yes
    filter:
      exclude:
        - active: '0'
          case_insensitive: '1'
          pattern: '\ncseq: *\d+ +(register|notify|options) '
      include: []
    sip_ports:
      - 5060
      - 5062
  interfaces:
    extra: []
    types:
      - sip_int
      - sip_ext
      - rtp_ext
  li_x1x2x3:
    call_id:
      del_patterns:
        - _pbx\-1(?:_[0-9]{1,10})?$
        - _b2b\-1(?:_[0-9]{1,10})?$
        - _xfer\-1(?:_[0-9]{1,10})?$
    captagent:
      cin_max: '3000'
      cin_min: '0'
      x2:
        threads: 20
    client_certificate: ''
```

```

enable: no
fix_checksums: no
fragmented: no
interface:
  excludes: []
local_name: sipwise
x1:
  port: '18090'
x23:
  protocol: sipwise
mysql_dump:
  enable: yes
  max_query_len: 67108864
  num_threads: '4'
rtp_filter: yes
threads_per_interface: '2'
partitions:
  increment: '700000'
  keep: '10'

```

admin\_panel should be set to 'yes' as well as start and mysql\_dump.enable. Also filter.exclude.active should be set to '1' in order to avoid to sniff REGISTER, NOTIFY, OPTIONS and SUBSCRIBE messages. Then run:

```
ngcpcfg apply 'enable voisniff' && ngcpcfg push
```

### WARNING

Please notice that enabling voisniff, specially under a huge amount of traffic, may affect the system performance due to the fact that voisniff needs to save all the traffic into the database.

## 13.14. Log file obfuscation

As many of the log files produced by Sipwise C5 contain sensitive and private data, and as various jurisdictions around the world have placed restrictions on who can view whose private data (e.g. GDPR in the EU), Sipwise C5 provides a mechanism to safely view log files in a partially obfuscated and anonymised (pseudonymised) fashion.

This obfuscated view is provided by the system service ngcp-logfs and is enabled by default. This service provides a read-only, partially obfuscated view of the Sipwise C5 log files in a separate folder, which by default is `/var/log/mirror-ngcp/`. The actual log files in `/var/log/ngcp/` are normally readable only by the system administrator (root), while the obfuscated view of them in `/var/log/mirror-ngcp/` is readable even by non-administrator system users by default.

Log files produced by Sipwise C5 contain special markers that identify data fields that correspond to private data belonging to 3rd parties. When accessing the log files through ngcp-logfs, the data contained in these fields will be replaced by other, seemingly random strings. However, this replacement is deterministic, meaning that the same original string will always be replaced with the same obfuscated string, making it still possible to correlate log lines belonging to the same entity, even across log files from different applications. Examples of such obfuscated data fields are user names, phone numbers, IP addresses, and other uniquely identifiable data fields.

The `ngcp-logfs` service also provides the same kind of access to archived (rotated) log files contained in `/var/log/ngcp/old/`. While these log files are compressed (.gz) on disk, they appear as uncompressed, plain text files when viewed through `ngcp-logfs`, as the service decompresses them in the background on demand.

### 13.14.1. Configuration

The service can be configured via its respective section in `/etc/ngcp-config/config.yml`:

```
logfs:
  cache_db: /usr/lib/ngcp-logfs/cache.db
  chmod_dirs: '0555'
  chmod_files: '0444'
  disk_retention_timeout: 365
  enable: yes
  file_cache_timeout: 2
  gid: 0
  log_dir: /var/log/ngcp
  max_mem_usage: 500
  mem_cache_timeout: 24
  mountpoint: /var/log/mirror-ngcp
  obfuscation_prefix: GDPR
  suffix: \.\\d+\\$|-\\d{8}\\$|-\\d{8}-\\d+\\$
  uid: 0
```

- `cache_db`: path and file name of the on-disk cache for obfuscated strings and their replacements. Does not normally need to be changed.
- `chmod_dirs`: Unix file mode for directories visible through `ngcp-logfs` in octal. Defaults to octal 0555 (world readable).
- `chmod_files`: Unix file mode for log files visible through `ngcp-logfs` in octal. Defaults to octal 0444 (world readable).
- `disk_retention_timeout`: how long to store obfuscated strings in the on-disk cache before they get deleted, in days. Defaults to 365 (one year).
- `enable`: master switch for the service itself, yes or no.
- `file_cache_timeout`: how long to cache obfuscated files (portions or entirely) in memory, in hours. Defaults to 2 hours.
- `gid`: numeric Unix group ID for presented files and directories. Defaults to 0 (root).
- `log_dir`: root directory of the log files that should be mirrored. Does not normally need to be changed.
- `max_mem_usage`: upper limit in megabytes for the in-memory cache for obfuscated files. If this limit is hit, the in-memory cache will start to get aggressively emptied, even if `file_cache_timeout` isn't yet reached. Defaults to 500 MB.
- `mem_cache_timeout`: how long to cache obfuscated strings and their replacements in memory, in hours. Defaults to 24 hours.
- `mountpoint`: where to make obfuscated log files visible in the file system.
- `obfuscation_prefix`: optional prefix that obfuscated strings are guaranteed to have, provided the

string is at least twice as long as the prefix. The prefix therefore should be kept short. Can be empty to disable this feature.

- `suffix`: regular expression to match the file name suffix for archived (rotated) log files. Does not normally need to be changed.
- `uid`: numeric Unix user ID for presented files and directories. Defaults to 0 (root).

**TIP**

Access to obfuscated log files can be further restricted by setting `chmod_files`, `chmod_dirs` and `uid` and/or `gid`. For example, to make log files accessible only to users belonging to the system group `adm` with group ID 4, set `gid` to 4, set `chmod_files` to 0440, and `chmod_dirs` to 0550, followed by executing `ngcpfg apply`.

### 13.14.2. Forward and reverse lookup

In some cases, for example for troubleshooting purposes, it can be necessary to determine the underlying unobfuscated plain text string from its obfuscated version, or perhaps even vice versa. For this purpose, the tool `ngcp-lookup-obfuscated` is provided, which can only be used by the system administrator (root). To perform a forward lookup (obfuscated string to unobfuscated), call it with the obfuscated string as its first argument. To perform a reverse lookup (unobfuscated to obfuscated), add the `-r` option.

For example, take the following sample log line provided by `ngcp-logfs`:

```
Mar 28 06:00:27 sp1 proxy[2544]: NOTICE: <script>: Sending reply S=200
Alive fs='127.0.0.1:5062' du='127.0.0.1:5060' -
R=«GDPRcarPrUHeRvvWF2JjGei2Lu0bUjQIgI» ID=«GDPRqOB2kvuAm0JC7zQN6E1w4K»
UA='sipsak 0.9.7pre'
```

The following commands would be used to perform both forward and reverse lookups on the call ID:

```
root@sp1:~# ngcp-lookup-obfuscated GDPRqOB2kvuAm0JC7zQN6E1w4K
1899127565@192.168.255.251
root@sp1:~# ngcp-lookup-obfuscated -r 1899127565@192.168.255.251
GDPRqOB2kvuAm0JC7zQN6E1w4K
```

**NOTE**

These lookups, in particular the reverse lookup, only work on strings that were actually processed by `ngcp-logfs`. You cannot use the reverse lookup procedure to obfuscate any arbitrary string that wasn't previously provided by `ngcp-logfs`. The lookup must also be performed on the same host on which `ngcp-logfs` performed the obfuscation. Lookups don't necessarily work on other hosts.

# Chapter 14. Monitoring and Alerting

## 14.1. Internal Monitoring

### 14.1.1. Service monitoring

The platform uses both *systemd* and *monit* daemons to monitor all essential services. Since Sipwise C5 runs in an active/standby mode, not all services are always running on both nodes, some of them will only run on the active node and be stopped on the standby node. The following commands show the most critical services on the platform:

- `ngcp-service summary` - to get the list of services and their current status,
- `systemctl status` - to get a tree of the services running,
- `systemctl list-units` - to get a list of the service states,
- `monit summary` - to get the list of services known to monit and their current status,
- `monit status` - to get the list of services known to monit with detailed status.

#### IMPORTANT

When you perform a stop/start/monitor/unmonitor operation on a service, *monit* affects other services that depend on the initial one. Hence, if you stop or unmonitor a service all services that depend on it will be stopped or unmonitored as well.

For example, `monit stop mysql` operation will stop `kamailio`, `sbc`, `asterisk` and some other services. Although the recommended way to operate on services is via the `ngcp-service` wrapper which will take care of abstracting the underlying process monitoring implementation.

If any service ever fails for whatever reason either the *systemd* or *monit* daemons will quickly restart it. When that happens, the daemon will send a notification email to the address specified in the `config.yml` file under the `general.adminmail` key. It will also send warning emails to this address under certain abnormal conditions, such as high memory consumption (> 75% is used) or high CPU load.

#### IMPORTANT

In order for *monit* to be able to send emails to the specified address, the local MTA (*exim4*) must be configured correctly. The CE edition's handbook contains more information about this in the *Installation* chapter.

### 14.1.2. System monitoring backend

The platform uses the *Prometheus* monitoring backend on new installations and on upgraded systems that have been migrated.

The platform uses various monitoring backend services to monitor many aspects of the system, including CPU, memory, swap, disk, filesystem, network, processes, NTP, Nginx, Redis and MySQL.

The gathered information is stored in *VictoriaMetrics* which is a long-term storage backend for *Prometheus*. NOTE: Both *VictoriaMetrics* and *Prometheus* can act as the *prometheus* server implementation, and are mutually exclusive in their execution.

### 14.1.3. Sipwise C5 specific monitoring via *ngcp-witnessd*

The platform uses the internal *ngcp-witnessd* service to monitor Sipwise C5 specific metrics or system metrics currently not tracked by the monitoring backend (via *Prometheus* exporters), including HA status, MTA, Kamailio, SIP and MySQL.

The gathered information is stored in *VictoriaMetrics* in the *ngcp* namespace on its time-series database.

**TIP**

Some of the data gathering can be disabled (most are enabled by default) through the *config.yml* file, and those data points will then either be missing from the database or be initialized with a stub value. This will then cascade into other subsystems using this monitoring information, such as *Grafana* dashboards or SNMP OIDs. The enable/disable flags can be found in the *witnessd.gather* section.

### 14.1.4. Monitoring data in the monitoring backend

The platform uses *VictoriaMetrics* as a long-term *Prometheus* time series database to store most of the metrics collected in the system.

On a Sipwise C5 each node stores its own metrics and the ones for their peer node, and in addition on CARRIER systems the management nodes store the metrics for all the nodes in the cluster. On new installations and migrated ones this is done with *Prometheus* instances on each peer, and a *VictoriaMetrics* instance on the management node which uses its *Prometheus* federation and scrapping support.

The monitoring data is used by various components of the platform, including *ngcp-collective-check*, *ngcp-snmp-agent* and by the statistics dashboard powered by *Grafana*.

The monitoring data can also be accessed directly by various means. On new installations by using the *promtool* command-line tool; or by using the HTTP API with *curl* (or other HTTP fetchers), or with the *NGCP::Prometheus::HTTP* perl module.

#### Monitoring metrics

See [Prometheus monitoring metrics](#) for detailed information about the list of *ngcp* namespaced metrics stored in the *Prometheus* monitoring database.

#### PromQL

See <https://prometheus.io/docs/prometheus/latest/querying/basics/> for information about PromQL, the query language used by *Prometheus*.

**TIP**

To get the list of all metrics for a specific namespace the following query can be used `{__name__=~"^namespace_+"}`.

## 14.2. Statistics Dashboard

The platform's administration interface (described in [Kick-off](#)) provides a graphical overview based on *Grafana* of the most important system health indicators, such as memory usage, load averages and disk usage. VoIP statistics, such as the number of concurrent active calls, the number of provisioned and registered subscribers, etc. is also present.

## 14.3. External Monitoring Using SNMP

### 14.3.1. Overview and Initial Setup

The Sipwise C5 exports a variety of cluster health data and statistics over the standard SNMP interface. By default, the SNMP interface can only be accessed locally. To make it possible to provide the SNMP data to an external system via SNMP v1 or v2c, the `config.yml` file needs to be edited and the list of allowed community names and allowed hosts/IP ranges must be populated. This list can be found under the `snmpd.communities` key and it consists of one or more hashes of name and sources key/values. The community name is the allowed community name, while sources is a list of IP address or IP blocks where to allow the requests from. For SNMP v3, the users need to be added with `ngcp-snmpd-adduser`, and can be deleted `ngcp-snmpd-deluser` (both commands are documented in their respective man pages).

The SNMP v3 support provides authenticated and encrypted access, where no weak or insecure algorithms are supported, contrary to SNMP v1 and v2c. But this might be at the cost of interoperability issues with old systems or hardware that do not implement SNMP v3, or some of the secure algorithms used.

The SNMP notifications (or traps) can also be configured in a similar way, to send them to an external system, by populating the `snmpd.trap_communities` key with name and targets key/values. The community trap name is the value that will be used when sending the trap, while the targets is a list of IP addresses where to send the trap.

The public communities with the localhost source and target are used for local testing of SNMP functionality. It is recommended that you leave these entries in place. Other legal sources can be formed as single IP addresses or IP blocks in IP/prefix notation, for example `192.168.115.0/24`. Other targets can be formed as single IP addresses.

The origin of the SNMP notifications for the SIPWISE MIBs can also be configured with the `snmpagent.traps.origin`. The supported modes are:

- `legacy`: The node triggering the condition and its peer (if available) will emit the trap, in addition the management node pair (if distinct) will also emit the trap. This was the original behavior.
- `mgmt`: Only the active management node will emit the trap. This is the current default.
- `distributed`: Only the node triggering the condition will emit the trap. For cluster-wide conditions (those that are not node-specific), this mode is equivalent to the `mgmt` mode.

The Sipwise C5 supports two types of SNMP traps. Event-based, sent whenever a state changes, with a single trap per tracked state. Alarm-based, sent on problematic conditions arising or clearing, with a different trap per state group, where the trap severity is included as part of the trap itself (in addition to the usual convention of documenting it in the MIB). These two types can be enabled or disabled independently (both are enabled by default), depending on the type of monitoring intended.

**TIP**

The event-based traps have been supported for longer, while the alarm-based traps were introduced in `mr9.5`, so if there are interoperability requirements with various Sipwise C5 versions, event-based traps have better availability, although with different properties.

**TIP**

To locally check if SNMP is working correctly, execute the command `snmpwalk -v2c -cpublic localhost .` (note the trailing dot). This will generate a long list of raw SNMP OIDs and their values, provided that the default SNMP community key has been left in place.

Alternatively the `ngcp-systems-tests` program checks whether several expected SNMP OIDs are present.

**TIP**

To locally check if SNMP notifications (or traps) are working correctly, enable the `snmptrapd` daemon, which will be configured by default to catch the traps sent by the localhost SNMP agent. The traps will show up on `/var/log/ngcp/snmp-trap.log`, and a couple of traps can be generated by running `ngcp-service restart snmpd`. Even though traps generated by `ngcp-snmp-agent` are logged on `/var/log/ngcp/snmp-agent.log`, because the service responsible for sending out the traps is `snmpd`, checking with `snmptrapd` is always an additional safety check in case of problems.

**TIP**

To get information from SNMP tables, you can use the command `snmptable -v2c -cpublic -Ci localhost TABLE-OID`, where **TABLE-OID** could be for example `procTable`.

**TIP**

When using `snmptable` you might want to use the `-S` option in `less` (either when calling it or typing it on its prompt) to get proper tabular output that does not fold on terminal end.

**NOTE**

SNMP version 1, version 2c and version 3 access is supported. Sending SNMP version 3 traps is not supported.

### 14.3.2. Details

There are two kinds of information that can be retrieved from SNMP OIDs (Object Identifiers). The first one is the native Sipwise C5 cluster overview from Sipwise C5 MIBs (Management Information Bases), which is available from the management nodes. The second is from the stock `snmpd` implementing the UCD (University of California, Davis) MIBs, which requires querying each individual node.

#### Sipwise C5 OIDs

The entire Sipwise C5 cluster can be monitored from the management nodes by using the `SIPWISE-NGCP-MIB`, `SIPWISE-NGCP-MONITOR-MIB` and `SIPWISE-NGCP-ALARMS-MIB`. These OIDs are rooted at Sipwise C5 slot `.1.3.6.1.4.1.34274.1.*`.

The MIBs are self-documented, and can be found as part of the `ngcp-snmp-mibs` package (running `dpkg -S 'SIPWISE*MIB'` will list their pathnames). The Sipwise C5 SNMP Agent is a part of the `ngcp-snmp-agent` package, which is installed by default and works out-of-the-box as long as the `snmpd` has been properly configured.

The `SIPWISE-NGCP-MIB` acts as the root MIB and provides information about the cluster licensing and layout (which is mostly static data about each node, such as node name, its IP address, its roles, etc.) and information required to access the OIDs from the other MIBs. The `clusterTable` defines the nodes layout of the cluster, and its cluster node index (`cnIndex`) is used by many of the other tables to index entries within that specific cluster node (for example within the `procTable` in the monitor MIB).

The `SIPWISE-NGCP-MONITOR-MIB` provides current monitoring information, global health conditions, the number of provisioned and registered subscribers and devices. It also provides per node information (independently of the number of nodes or their names) on their filesystem, processes, databases, system load, memory, HA status, MTA queues, etc. In addition it defines the event-based traps.

The `SIPWISE-NGCP-ALARMS-MIB` defines the alarm-based traps.

**NOTE**

OIDs under the following trees are not yet implemented: `ngcpMonitorFraud`,

*ngcpMonitorPerformance.sipStatsTable.sipCallAttemptsPerSecond*. Deprecated OIDs are currently implemented but will eventually be obsoleted. Obsolete OIDs are not implemented and won't be in the future.

**NOTE**

The Sipwise C5 SNMP Agent uses *Redis* and *Prometheus* as data sources. This data is essential for accurate and complete monitoring data in the SNMP OID tree. In addition, the *Redis* database must be available on a shared IP address, so that *ngcp-witnessd* can always write to it.

**UCD OIDs**

All basic system health variables (such as memory, disk, swap, CPU usage, network statistics, process lists, etc.) for every node can also be found in standard OID slots from standard MIBs from each node. For example, memory statistics can be found through the *UCD-SNMP-MIB* in OIDs such as *memTotalSwap.0*, *memAvailSwap.0*, *memTotalReal.0*, *memAvailReal.0*, etc., which translate to numeric OIDs *.1.3.6.1.4.1.2021.4.\**. In fact, *UCD-SNMP-MIB* is a useful MIB for overall non-centralized system health checks.

Additionally, there is a list of specially monitored processes, also found through the *UCD-SNMP-MIB*. *UCD-SNMP-MIB::prNames* (*.1.3.6.1.4.1.2021.2.1.2*) gives the list of monitored processes, *prCount* (*.1.3.6.1.4.1.2021.2.1.5*) is how many of each process are running and *prErrorFlag* (*.1.3.6.1.4.1.2021.2.1.100*) gives a 0/1 error indication (with *prErrorMessage* (*.1.3.6.1.4.1.2021.2.1.101*) providing an explanation of any error).

**TIP**

Some of these processes are not supposed to be running on the standby node, so you will see the error flag raised there. A possible solution is to run these SNMP checks against the shared service IP of the cluster. See in [High Availability and Fail-Over](#) below for more information.

**IMPORTANT**

Furthermore, Sipwise C5 used to provide platform specific information via the *UCD-SNMP-MIB* custom external extension OIDs, which have been superseded by the Sipwise MIBs, and need to be migrated to use the latter. The names of these OIDs could be found under the *UCD-SNMP-MIB::extNames* (*.1.3.6.1.4.1.2021.8.1.2*) tree, with *extOutput* (*.1.3.6.1.4.1.2021.8.1.101*) providing the output (one line) from each check and *extResult* (*.1.3.6.1.4.1.2021.8.1.100*) the exit code from each check. The following table gives a rough mapping for that migration:

UCD OID name	UCD check name	SIPWISE-NGCP OID name
UCD-SNMP-MIB::extNames.1	collective_check	SIPWISE-NGCP-MONITOR-MIB::ngcpCollectiveCheckResult and SIPWISE-NGCP-MONITOR-MIB::ngcpCollectiveCheckOutput
UCD-SNMP-MIB::extNames.2	sip_check_sp1	SIPWISE-NGCP-MONITOR-MIB::sipResponsiveness.*
UCD-SNMP-MIB::extNames.3	sip_check_sp2	SIPWISE-NGCP-MONITOR-MIB::sipResponsiveness.*
UCD-SNMP-MIB::extNames.4	mysql_check_sp1	SIPWISE-NGCP-MONITOR-MIB::dbQueryRate.*

UCD OID name	UCD check name	SIPWISE-NGCP OID name
UCD-SNMP-MIB::extNames.5	mysql_check_sp2	SIPWISE-NGCP-MONITOR-MIB::dbQueryRate.*
UCD-SNMP-MIB::extNames.6	mysql_replication_check_sp1	SIPWISE-NGCP-MONITOR-MIB::dbReplDelay.*
UCD-SNMP-MIB::extNames.7	mysql_replication_check_sp2	SIPWISE-NGCP-MONITOR-MIB::dbReplDelay.*
UCD-SNMP-MIB::extNames.8	mpt_check_sp1	Obsolete
UCD-SNMP-MIB::extNames.9	mpt_check_sp2	Obsolete
UCD-SNMP-MIB::extNames.10	exim_queue_check_sp1	SIPWISE-NGCP-MONITOR-MIB::mailQueue.*
UCD-SNMP-MIB::extNames.11	exim_queue_check_sp2	SIPWISE-NGCP-MONITOR-MIB::mailQueue.*
UCD-SNMP-MIB::extNames.12	provisioned_subscribers_check_sp1	SIPWISE-NGCP-MONITOR-MIB::ngcpClusterProvSubs
UCD-SNMP-MIB::extNames.13	provisioned_subscribers_check_sp2	SIPWISE-NGCP-MONITOR-MIB::ngcpClusterProvSubs
UCD-SNMP-MIB::extNames.14	kam_dialog_active_check_sp1	SIPWISE-NGCP-MONITOR-MIB::sipDialogActive.*
UCD-SNMP-MIB::extNames.15	kam_dialog_active_check_sp2	SIPWISE-NGCP-MONITOR-MIB::sipDialogActive.*
UCD-SNMP-MIB::extNames.16	kam_dialog_early_check_sp1	SIPWISE-NGCP-MONITOR-MIB::sipEarlyMedia.*
UCD-SNMP-MIB::extNames.17	kam_dialog_early_check_sp2	SIPWISE-NGCP-MONITOR-MIB::sipEarlyMedia.*
UCD-SNMP-MIB::extNames.18	kam_dialog_type_local_check_sp1	SIPWISE-NGCP-MONITOR-MIB::sipDialogLocal.*
UCD-SNMP-MIB::extNames.19	kam_dialog_type_local_check_sp2	SIPWISE-NGCP-MONITOR-MIB::sipDialogLocal.*
UCD-SNMP-MIB::extNames.20	kam_dialog_type_relay_check_sp1	SIPWISE-NGCP-MONITOR-MIB::sipDdialogRelay.*
UCD-SNMP-MIB::extNames.21	kam_dialog_type_relay_check_sp2	SIPWISE-NGCP-MONITOR-MIB::sipDdialogRelay.*
UCD-SNMP-MIB::extNames.22	kam_dialog_type_incoming_check_sp1	SIPWISE-NGCP-MONITOR-MIB::sipDdialogIncoming.*
UCD-SNMP-MIB::extNames.23	kam_dialog_type_incoming_check_sp2	SIPWISE-NGCP-MONITOR-MIB::sipDdialogIncoming.*
UCD-SNMP-MIB::extNames.24	kam_dialog_type_outgoing_check_sp1	SIPWISE-NGCP-MONITOR-MIB::sipDdialogOutgoing.*
UCD-SNMP-MIB::extNames.25	kam_dialog_type_outgoing_check_sp2	SIPWISE-NGCP-MONITOR-MIB::sipDdialogOutgoing.*

UCD OID name	UCD check name	SIPWISE-NGCP OID name
UCD-SNMP-MIB::extNames.26	kam_usrloc_regusers_check_sp1	SIPWISE-NGCP-MONITOR-MIB::ngcpClusterRegSubs
UCD-SNMP-MIB::extNames.27	kam_usrloc_regusers_check_sp2	SIPWISE-NGCP-MONITOR-MIB::ngcpClusterRegSubs
UCD-SNMP-MIB::extNames.28	kam_usrloc_regdevices_check_sp1	SIPWISE-NGCP-MONITOR-MIB::ngcpClusterRegDevs
UCD-SNMP-MIB::extNames.29	kam_usrloc_regdevices_check_sp2	SIPWISE-NGCP-MONITOR-MIB::ngcpClusterRegDevs
UCD-SNMP-MIB::extNames.30	mysql_replication_discrepancies_check_sp1	Obsolete
UCD-SNMP-MIB::extNames.31	mysql_replication_discrepancies_check_sp2	Obsolete
UCD-SNMP-MIB::extNames.32	sip_check_self	SIPWISE-NGCP-MONITOR-MIB::sipResponsiveness.*
UCD-SNMP-MIB::extNames.33	mysql_check_self	SIPWISE-NGCP-MONITOR-MIB::dbQueryRate.*
UCD-SNMP-MIB::extNames.34	mysql_replication_check_self	SIPWISE-NGCP-MONITOR-MIB::dbReplDelay.*
UCD-SNMP-MIB::extNames.35	mpt_check_self	Obsolete
UCD-SNMP-MIB::extNames.36	exim_queue_check_self	SIPWISE-NGCP-MONITOR-MIB::mailQueue.*
UCD-SNMP-MIB::extNames.37	provisioned_subscribers_check_self	SIPWISE-NGCP-MONITOR-MIB::ngcpClusterProvSubs
UCD-SNMP-MIB::extNames.38	kam_dialog_active_check_self	SIPWISE-NGCP-MONITOR-MIB::sipDialogActive.*
UCD-SNMP-MIB::extNames.39	kam_dialog_early_check_self	SIPWISE-NGCP-MONITOR-MIB::sipEarlyMedia.*
UCD-SNMP-MIB::extNames.40	kam_dialog_type_local_check_self	SIPWISE-NGCP-MONITOR-MIB::sipDialogLocal.*
UCD-SNMP-MIB::extNames.41	kam_dialog_type_relay_check_self	SIPWISE-NGCP-MONITOR-MIB::sipDialogRelay.*
UCD-SNMP-MIB::extNames.42	kam_dialog_type_incoming_check_self	SIPWISE-NGCP-MONITOR-MIB::sipDialogIncoming.*
UCD-SNMP-MIB::extNames.43	kam_dialog_type_outgoing_check_self	SIPWISE-NGCP-MONITOR-MIB::sipDialogOutgoing.*
UCD-SNMP-MIB::extNames.44	kam_usrloc_regusers_check_self	SIPWISE-NGCP-MONITOR-MIB::ngcpClusterRegSubs
UCD-SNMP-MIB::extNames.45	kam_usrloc_regdevices_check_self	SIPWISE-NGCP-MONITOR-MIB::ngcpClusterRegDevs
UCD-SNMP-MIB::extNames.46	mysql_replication_discrepancies_check_self	Obsolete

<b>UCD OID name</b>	<b>UCD check name</b>	<b>SIPWISE-NGCP OID name</b>
UCD-SNMP-MIB::extNames.47	kam_dialog_type_local_check_prx0X	SIPWISE-NGCP-MONITOR-MIB::sipDialogLocal.*
UCD-SNMP-MIB::extNames.48	kam_dialog_type_relay_check_prx0X	SIPWISE-NGCP-MONITOR-MIB::sipDialogRelay.*
UCD-SNMP-MIB::extNames.49	kam_dialog_type_incoming_check_prx0X	SIPWISE-NGCP-MONITOR-MIB::sipDialogIncoming.*
UCD-SNMP-MIB::extNames.50	kam_dialog_type_outgoing_check_prx0X	SIPWISE-NGCP-MONITOR-MIB::sipDialogOutgoing.*
UCD-SNMP-MIB::extNames.51	kam_dialog_active_check_prx0X	SIPWISE-NGCP-MONITOR-MIB::sipDialogActive.*
UCD-SNMP-MIB::extNames.52	kam_dialog_early_check_prx0X	SIPWISE-NGCP-MONITOR-MIB::sipEarlyMedia.*

# Chapter 15. Licenses

The Sipwise C5 implements *software licensing* in form of a regular comparison of the licensed services and capacities against the actual usage patterns of the platform. The purpose of this function is to monitor system usage and to raise warnings to the platform operator if the thresholds of commercially agreed license parameters (like number of provisioned subscribers or number of concurrent calls) are exceeded.

## 15.1. What is Subject to Licensing?

Sipwise C5 licenses determine 2 groups of system parameters which are regularly compared with actual values gathered from the system:

- **performance parameters:**

- number of provisioned subscribers
- number of provisioned PBX subscribers
- number of provisioned PBX groups
- number of registered subscribers
- number of concurrent calls

- **feature parameters:** additional features / services that are subject to commercial agreement:

- Billing engine
- Pre-paid billing
- Invoice generation
- CPBX (Cloud PBX) services
- Push notifications (mobile SIP clients on iOS and Android)
- Lawful Interception services
- SIP capturing via ngcp-voisniff
- Zero touch device provisioning
- Mail-to-Fax and Fax-to-Mail for subscribers
- Third-Party Call Control to manage calls and devices
- Call Recording feature
- Call Transfers feature
- Transcoding of the calls
- Phonebook for subscribers, customers and resellers
- Header Manipulation feature
- Batch Provisioning feature to easily provision big amount of data
- Least Cost Routing
- Batch LNP Importer
- Customer Self-Care interface for subscribers

Customer Self-Care WebRTC client for subscribers

Reseller creation

SMS feature

Intergration with External LNP services

Advice of Charge feature

#### NOTE

Please remember, that the parameter 'number of concurrent calls' by default doesn't affect emergency type of calls. If you would like to change this behavior globally, you can set the config.yml option 'b2b.sbc.skip\_cpslimit\_license\_check\_emergency' to 'no' (which is by default set to 'yes'). Remember, by applying the changes the SEMS-B2B component will have to restart.

## 15.2. How Licensing Works

Sipwise operates a *licensing server* that is the source of license data for each deployed Sipwise C5 node. The nodes themselves request licensing data from the license server regularly and compare them with actual system performance indicators, check the activated features against the licensed ones. The presence and activity of the *license client* module ("licensed" process) may be confirmed by checking e.g. the output of "ngcp-service summary" command. It should contain a line showing:

```
ngcp-license-client          managed    on-boot    active
```

All nodes of a single Sipwise C5 installation share the same license key. This is also valid for geographically distributed setups. This license key is referred by an ID that has to be configured in the main Sipwise C5 configuration file (config.yml), and that ID will be used to request license data from the license server.

In order for the license validation to work the management node of an Sipwise C5 installation must be able to connect to the Sipwise license server via standard HTTPS protocol (TCP, port 443). Alternatively the node may use a local, system-wide proxy server and only that proxy server needs to access the Sipwise license server.

## 15.3. How to Configure Licenses

The Sipwise C5 operator can set the **license key** in the main configuration file (/etc/ngcp-config/config.yml). The correct license key has to be entered in the configuration file, at the **general.license\_key** configuration parameter, so that licensing works as expected.

The license key is also shown in the /etc/ngcp-license-key file once the key has been added to the configuration file and the new configuration has been applied.

#### NOTE

There is another configuration parameter related to licenses: **general.anonymous\_usage\_statistics** that has an effect on Sipwise C5 CE installations only. This parameter enables / disables sending anonymous usage statistics to Sipwise.

## 15.4. How to Monitor License Client

### 15.4.1. Using the terminal

As mentioned earlier in this chapter, the presence of license client can be monitored using the built-in utility `ngcp-service`.

The other way to observe the behaviour of the license client is looking into the log file of "licensed" process: `/var/log/ngcp/licensed.log`

The Sipwise C5 operator may find entries like the below ones in case of normal operation:

```
Aug 06 16:20:42 sp1 ngcp-licensed[2205]: Valid license:
[ABCDEFGHI_123456789_a1b2c3d4e5f6]:
  10 calls, 50 subscribers, 10 registered subscribers, 30 PBX
subscribers, 20 PBX groups,
  valid until Mon Sep 30 10:00:00 2024 (signature valid until Wed Aug 7
16:42:37 2024)
Aug 06 16:22:41 sp1 ngcp-licensed[2205]: Usage report: 0 calls, 21
subscribers,
  3 registered subscribers,5 PBX subscribers, 0 PBX groups, status 0
```

where:

1. The first line shows *the licensed capacities*
2. The second line shows *the actual system usage indicators*

**NOTE**

license warnings and errors are also printed when logging in to the Sipwise C5 system using SSH as part of the 'message of the day' (Motd).

### 15.4.2. Using the admin web interface

Another possibility to monitor the licenses is to access the administrative web interface of the Sipwise C5 installation and navigate to the page 'Monitoring & Statistics' > 'License Status'. The page reports at the top all the warnings or errors returned by the license client running on the system. In the rest of the page the current performance parameters and available licenses are shown.

### 15.4.3. Using SNMP

The Sipwise C5 provides a dedicated SNMP endpoint to monitor the status of the license in all the nodes of the system. Please refer to [SNMP Monitoring chapter](#) to have additional details.

# Chapter 16. Customer Self-Care

## 16.1. Customer Self-Care User Interface (CSC UI)

There are two ways for end users to maintain their subscriber settings: via the *Customer Self-Care Web Interface* (old/Perl or new/JS versions) and via *Vertical Service Codes* using their SIP phones.

## 16.2. The Customer Self-Care Web Interface

The Sipwise C5 provides a web panel for end users (CSC panel) to maintain their subscriber accounts, which is running on <https://ngcp-ip>. Every subscriber can log in there, change subscriber feature settings, view their call lists, retrieve voicemail messages and trigger calls using the click-to-dial feature.

The CSC UI is technically a Single Page Application, that is fully client side rendered and builds on top of the NCGP REST API as a part of the Service Oriented Architecture. The CSC UI source code is published under a GPL license on <https://github.com/sipwise/ngcp-csc-ui> and can be also used as a guideline towards own CSC UI implementation based on the same REST API methods.

### 16.2.1. Login Procedure

To log into the CSC panel, the end user has to provide his full web username (e.g. user1@203.0.113.42) and the "web password" defined in [Creating a Subscriber](#). Once logged in, he can change his web password in the *Account* section. This will NOT change his SIP password, so if you control the end user devices, you can auto-provision the SIP password into the device and keep it secret, and hand over the web password to the customer. This way, the end user will only be able to place calls with this auto-provisioned device and not with an arbitrary soft-phone, but can nonetheless manage his account via the CSC panel.

### 16.2.2. Site Customization

As an operator (as well as a Reseller), you can change the branding logo of the Customer Self-Care (CSC) panel and the available languages on the CSC panel. This is possible via the admin web interface.

#### Changing the Logo

For changing the branding logo on a reseller's admin web page and on the CSC panel you need to access the web interface **as Administrator** and navigate to *Reseller* menu. Once there click on the *Details* button for your selected reseller, finally select *Branding*.

In order to do the same **as Reseller**, login on the admin web interface with the reseller's web credentials, then access the *Panel Branding* menu.

The web panel customisation happens as follows:

1. Press the *Edit Branding* button to start the customisation process.
2. Press the *Browse* button to select an image for the new logo:

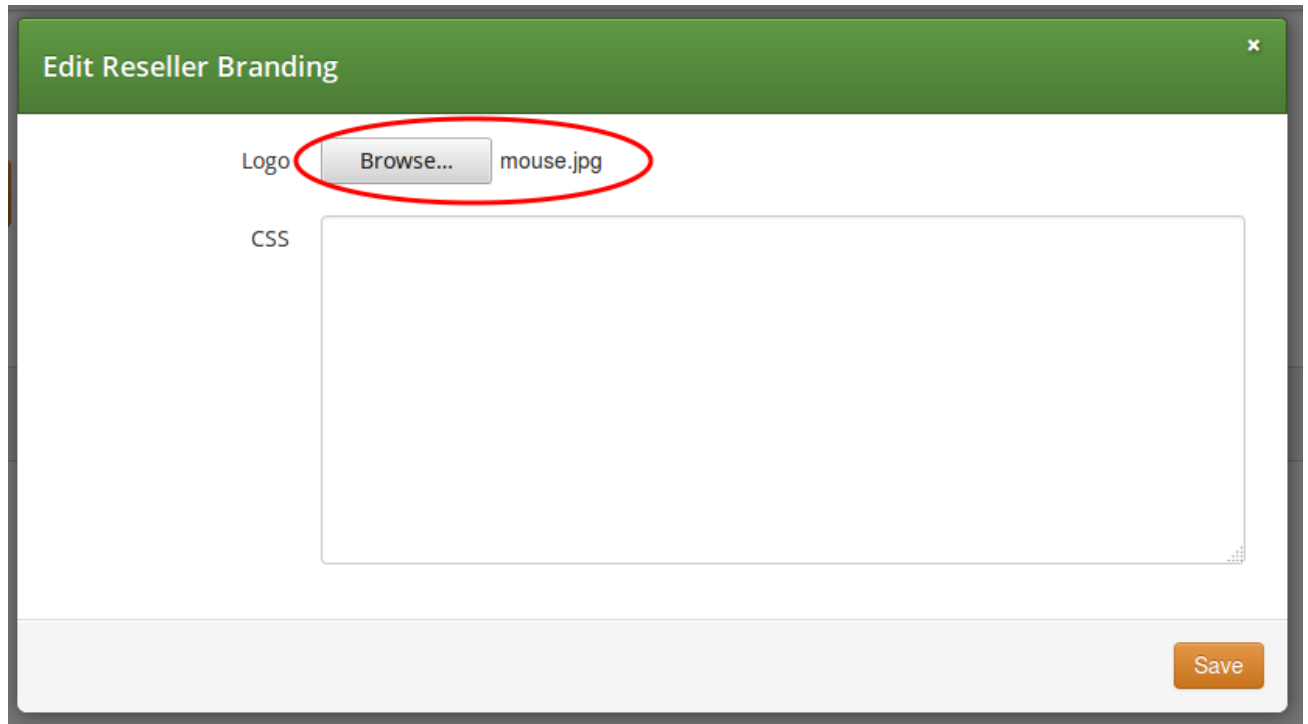

Figure 223. CSC Customisation Step 1: Select an image

3. Press the *Save* button to save changes.
4. Select and copy the auto-generated CSS code from the text box below the uploaded image:

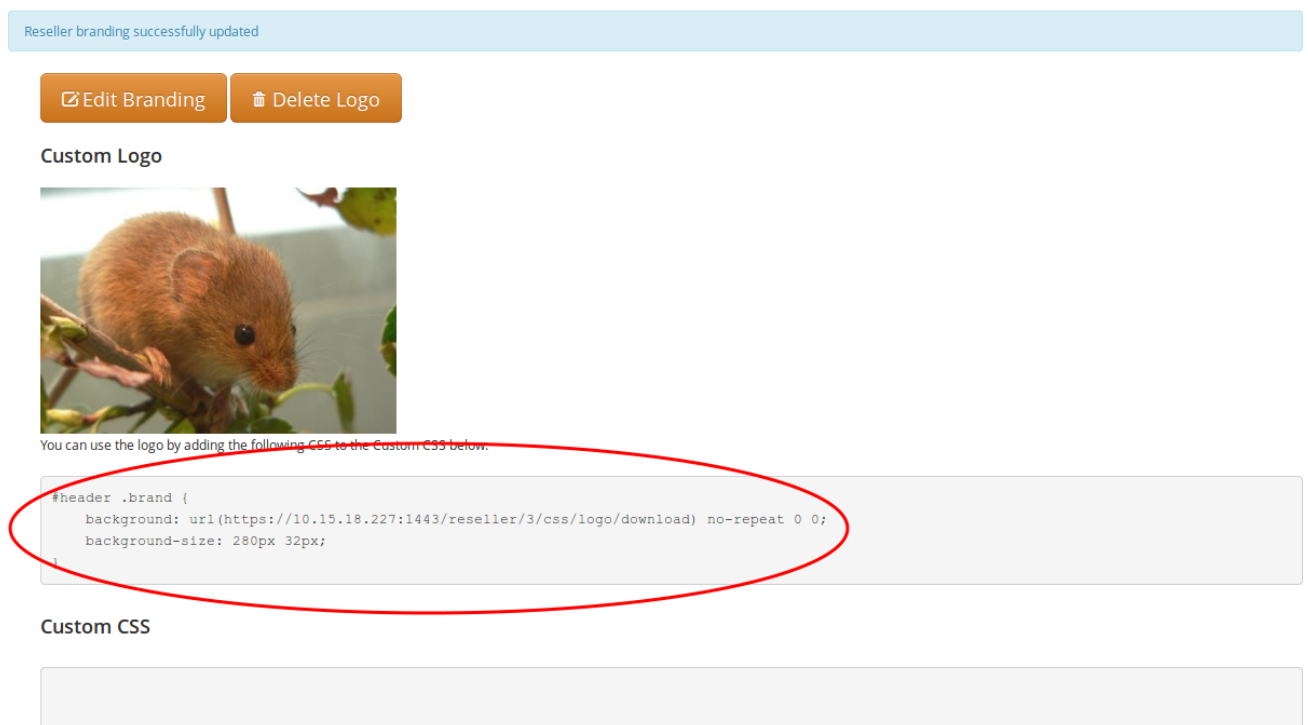

Figure 224. CSC Customisation Step 2: Copy CSS code

5. Press the *Edit Branding* button again.
6. Paste the CSS code into CSS text box and *Save* the changes:

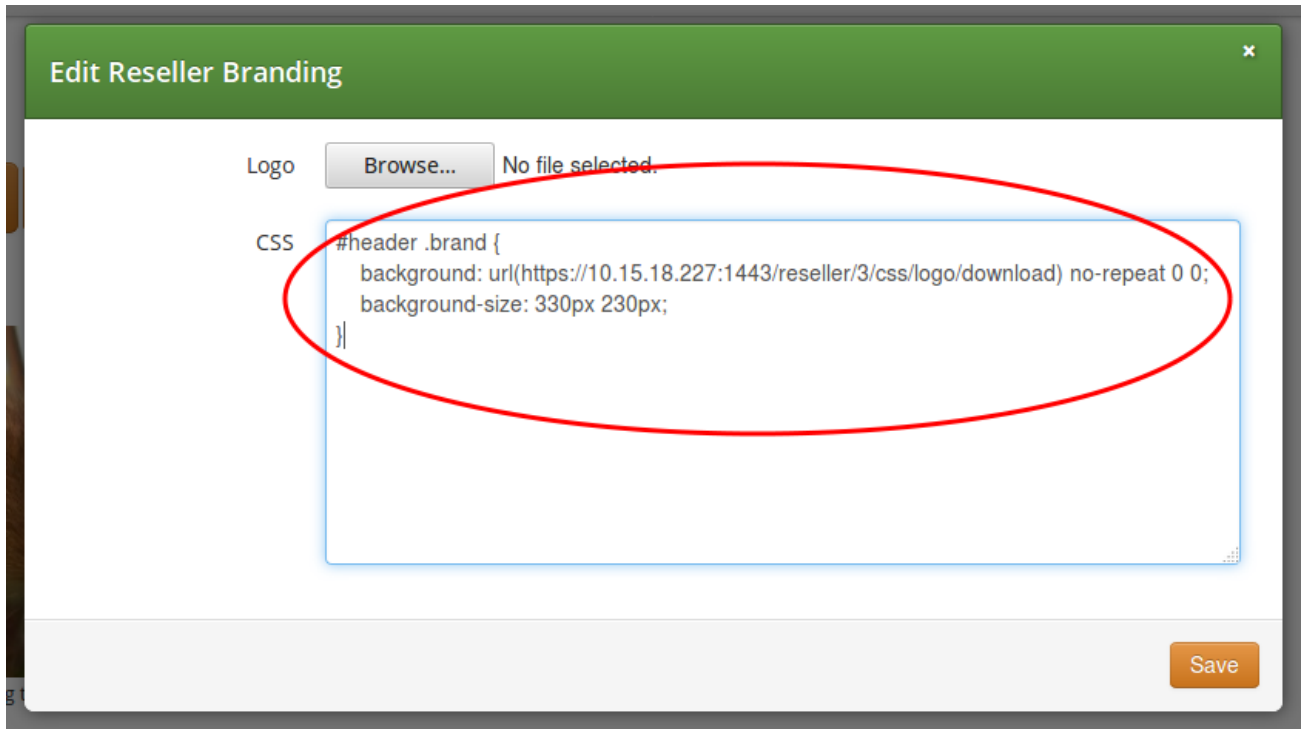

Figure 225. CSC Customisation Step 3: Paste CSS code

7. Now the new logo is already visible on the admin / CSC panel. If you want to hide the Sipwise copyright notice at the bottom of the web panels, add a line of CSS code as shown here:

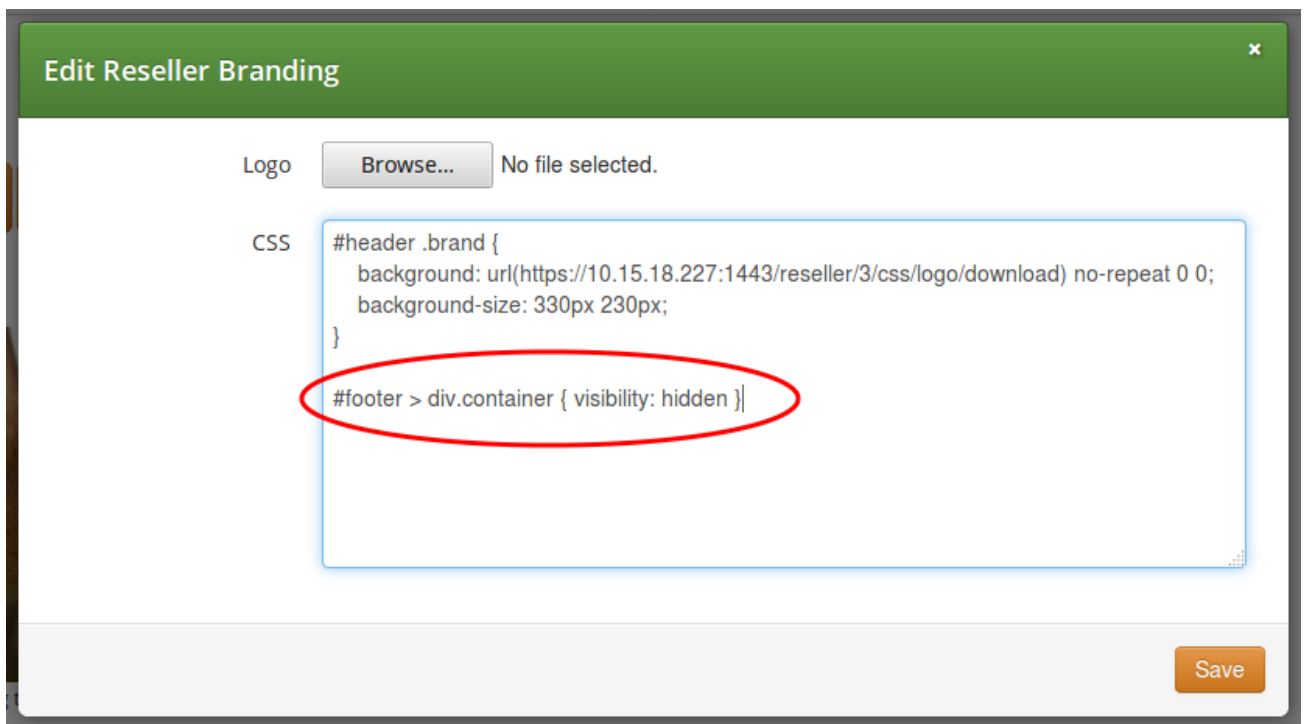

Figure 226. CSC Customisation: Hide copyright notice

8. The final branding data is shown on the admin web panel:

Reseller branding successfully updated

[Edit Branding](#)
[Delete Logo](#)

### Custom Logo



You can use the logo by adding the following CSS to the Custom CSS below:

```
#header .brand {
  background: url(https://10.15.18.227:1443/reseller/3/css/logo/download) no-repeat 0 0;
  background-size: 280px 32px;
}
```

### Custom CSS

```
#header .brand {
  background: url(https://10.15.18.227:1443/reseller/3/css/logo/download) no-repeat 0 0;
  background-size: 330px 230px;
}

#footer > div.container { visibility: hidden }
```

Figure 227. CSC Customisation: Custom data on panel

#### WARNING

Only experienced users with profound CSS knowledge are advised to change web panel properties in the main CSS file. *Sipwise does not recommend and also does not support the modification of the main CSS file.*

## Other Website Customisations

*Branding* section allows also to change the font and the background color used in the CSC interface. To do so, select the desired color in the fields *CSC font color* and *CSC background color*.

## Selecting Available Languages

You can also enable/disable specific languages a user can choose from in the CSC panel. Currently, English (en), German (de), Italian (it) and Spanish (es) are supported, and the default language is the same as the browser's preferred one.

You can select the *default language* provided by CSC by changing the parameter `www_admin.force_language` in `/etc/ngcp-config/config.yml` file. An example to set the English language as default:

```
ngcpcfg set /etc/ngcp-config/config.yml www_admin.force_language=en
ngcpcfg apply 'Set English as default on CSC'
ngcpcfg push-parallel all
```

## 16.3. The Voicemail Menu

Sipwise C5 offers several ways to access the Voicemail box.

The CSC panel allows your users to listen to voicemail messages from the web browser, delete them and call back the user who left the voice message. User can setup voicemail forwarding to the external email and the PIN code needed to access the voicebox from any telephone also from the CSC panel.

**To manage the voice messages from SIP phone:** dial internal voicemail access number **2000**.

To change the access number: look for the parameter `voicemail_number` in `/etc/ngcp-config/config.yml` in the section `semsvsc`. After the changes, execute `ngcpcfg apply 'changed voicebox number'`.

### TIP

To let the callers leave a voice message when user is not available he should enable Call Forward to Voicebox. The Call Forward can be provisioned from the CSC panel as well as by dialing Call Forward VSC with the voicemail number. E.g. when parameter `voicemail_number` is set to `9999`, a Call Forward on Not Available to the Voicebox is set if the user dials **\*93\*9999**. As a result, all calls will be redirected to the Voicebox if SIP phone is not registered.

**To manage the voice messages from any phone:**

- As an operator, you can setup some DID number as external voicemail access number: for that, you should add a special rewrite rule (Inbound Rewrite Rule for Callee, see [Configuring Rewrite Rule Sets](#).) on the incoming peer, to rewrite that DID to "voiceboxpass". Now when user calls this number the call will be forwarded to the voicemail server and he will be prompted for mailbox and password. The mailbox is the full E.164 number of the subscriber account and the password is the PIN set in the CSC panel.
- The user can also dial his own number from PSTN, if he setup Call Forward on Not Available to the Voicebox, and when reaching the voicemail server he can interrupt the "user is unavailable" message by pressing '\*' key and then be prompted for the PIN. After entering PIN and confirming with '#' key he will enter own voicemail menu. PIN is random by default and must be kept secret for that reason.

## 16.4. Company Hours

**NOTE** | it is available on the new CSC UI only.

The subsection "Company Hours" under the CSC UI "Call Forward" allows the user to specify Call Forwarding Rules for a specific period of time. The time defined in this subsection represents the office hours of the company. The first step is to define the actual days and the according times. Each time entry consists of day, start-time, and end-time. You can define multiple times for the same day, to get a different behavior with the breaks and the office hours. If the current times are not in one of the defined periods, the system falls back to the subsection "Always". Specific dates or date ranges can not be defined. The functionality is limited to weekdays and its timing.

The feature "Company Hours" is a virtual Sipwise C5 function which is based on Sipwise C5 core functionality Subscribers "Unconditional Call Forwarding" which is enhanced with the "Time sets" and "Sounds set" to achieve the necessary functionality.

The feature "Company Hours" can be managed using REST API methods `CFDestinationSet`, `CFMapping`,

CFSourceSet and CFTimeSet. Please check all available options for those methods in a public REST API documentation.

# Chapter 17. REST API

The Sipwise C5 provides the REST API interface for interconnection with 3rd party tools.

The Sipwise C5 provides a REST API to provision various functionality of the platform. The entry point - and at the same time the official documentation - is at <https://<your-ip>:1443/api>. It allows both administrators and resellers (in a limited scope) to manage the system.

You can either authenticate via username and password of your administrative account you're using to access the admin panel, or via SSL client certificates. With username and password it is recommended to stick with the *local* authentication mode rather than remote authentication (e.g. *LDAP*), in order to prevent overloading the remote server. For client certificate authentication, there are details provided in the online API documentation.

## 17.1. API Workflows for Customer and Subscriber Management

The typical tasks done on the API involve managing customers and subscribers. The following chapter focuses on creating, changing and deleting these resources.

The standard life cycle of a customer and subscriber is:

1. Create customer contact
2. Create customer
3. Create subscribers within customer
4. Modify subscribers
5. Modify subscriber preferences (features)
6. Terminate subscriber
7. Terminate customer

The boiler-plate to access the REST API is described in the online API documentation at `/api/#auth`. A simple example in Perl using password authentication looks as follows:

```
#!/usr/bin/perl -w
use strict;
use v5.10;

use LWP::UserAgent;
use JSON qw();

my $uri = 'https://ngcp.example.com:1443';
my $ua = LWP::UserAgent->new;
my $user = 'myusername';
my $pass = 'mypassword';
$ua->credentials('ngcp.example.com:1443', 'api_admin_http', $user,
    $pass);
my ($req, $res);
```

For each customer you create, you need to assign a billing profile id. You either have the ID stored somewhere else, or you need to fetch it by searching for the billing profile handle.

```
my $billing_profile_handle = 'my_test_profile';
$req = HTTP::Request->new('GET',
"$uri/api/billingprofiles/?handle=$billing_profile_handle");
$res = $ua->request($req);
if($res->code != 200) {
    die "Failed to fetch billing profile: ".$res->decoded_content."\n";
}
my $billing_profile = JSON::from_json($res->decoded_content);
my $billing_profile_id = $billing_profile->{_embedded}-
>{'ngcp:billingprofiles'}->{id};
say "Fetched billing profile, id is $billing_profile_id";
```

A customer is mainly a billing container for subscribers without a real identification other than the *external\_id* property you might have stored somewhere else (e.g. the ID of the customer in your CRM). To still easily identify a customer, a customer contact is required. It is created using the */api/customercontacts/* resource.

```
$req = HTTP::Request->new('POST', "$uri/api/customercontacts/");
$req->header('Content-Type' => 'application/json');
$req->content(JSON::to_json({
    firstname => 'John',
    lastname => 'Doe',
    email => 'john.doe@example.com'
}));
$res = $ua->request($req);
if($res->code != 201) {
    die "Failed to create customer contact: ".$res->
    >decoded_content."\n";
}
my $contact_id = $res->header('Location');
$contact_id =~ s/^.+\/(\d+)$\/$1/; # extract the ID from the Location
header
say "Created customer contact, id is $contact_id";
```

### IMPORTANT

To get the ID of the recently created resource, you need to parse the *Location* header. In future, this approach will be changed for POST requests. The response will also optionally return the ID of the resource. It will be controlled via the *Prefer: return=representation* header as it is already the case for PUT and PATCH.

### WARNING

The example above implies the fact that you access the API via a reseller user. If you are accessing the API as the admin user, you also have to provide a *reseller\_id* parameter defining the reseller this contact belongs to.

Once you have created the customer contact, you can create the actual customer.

```
$req = HTTP::Request->new('POST', "$uri/api/customers/");
```

```

$req->header('Content-Type' => 'application/json');
$req->content(JSON::to_json({
    status => 'active',
    contact_id => $contact_id,
    billing_profile_id => $billing_profile_id,
    type => 'sipaccount',
    external_id => undef, # can be set to your crm's customer id
}));
$res = $ua->request($req);
if($res->code != 201) {
    die "Failed to create customer: ".$res->decoded_content."\n";
}
my $customer_id = $res->header('Location');
$customer_id =~ s/^.+\/(\d+)/$1/; # extract the ID from the Location
header
say "Created customer, id is $customer_id";

```

Once you have created the customer, you can add subscribers to it. One customer can hold multiple subscribers, up to the *max\_subscribers* property which can be set via */api/customers/*. If this property is not defined, a virtually unlimited number of subscribers can be added.

```

$req = HTTP::Request->new('POST', "$uri/api/subscribers/");
$req->header('Content-Type' => 'application/json');
$req->content(JSON::to_json({
    status => 'active',
    customer_id => $customer_id,
    primary_number => { cc => 43, ac => 9876, sn => 10001 }, # the main
number
    alias_numbers => [ # as many alias numbers the subscriber can be
reached at (or skip param if none)
        { cc => 43, ac => 9877, sn => 10001 },
        { cc => 43, ac => 9878, sn => 10001 }
    ],
    username => 'test_10001'
    domain => 'ngcp.example.com',
    password => 'secret subscriber pass',
    webusername => 'test_10001',
    webpassword => undef, # set undef if subscriber shouldn't be able to
log into sipwise csc
    external_id => undef, # can be set to the operator crm's subscriber
id
}));
$res = $ua->request($req);
if($res->code != 201) {
    die "Failed to create subscriber: ".$res->decoded_content."\n";
}
my $subscriber_id = $res->header('Location');
$subscriber_id =~ s/^.+\/(\d+)/$1/; # extract the ID from the Location
header
say "Created subscriber, id is $subscriber_id";

```

**IMPORTANT**

A domain must exist before creating a subscriber. You can create the domain via `/api/domains/`.

At that stage, the subscriber can connect via SIP, and can be reached via the primary number, all alias numbers, as well as via the SIP URI.

If you want to set call forwards for the subscribers, then perform an API call as follows.

```
$req = HTTP::Request->new('PUT',
"$uri/api/callforwards/$subscriber_id");
$req->header('Content-Type' => 'application/json');
$req->header('Prefer' => "return=minimal"); # use return=representation
to get full json response
$req->content(JSON::to_json({
  cfna => { # set a call-forward if subscriber is not registered
    destinations => [
      { destination => "4366610001", timeout => 10 }, # ring this
for 10s
      { destination => "4366710001", timeout => 300 }, # if no
answer, ring that for 300s
    ],
    times => undef # no time-based call-forward, trigger cfna always
  }
}));
$res = $ua->request($req);
if($res->code != 204) { # if return=representation, it's 200
  die "Failed to set cfna for subscriber: ".$res->
>decoded_content."\n";
}
```

You can set cfu, cfna, cfb, cft, cfs, cfr and cfo via this API call, also all at once. Destinations can be hunting lists as described above or just a single number. Also, a time set can be provided to trigger call forwards only during specific time periods.

To provision certain features of a subscriber, you can manipulate the subscriber preferences. You can find a full list of preferences available for a subscriber at `/api/subscriberpreferencedefs/`.

```
$req = HTTP::Request->new('GET',
"$uri/api/subscriberpreferences/$subscriber_id");
$res = $ua->request($req);
if($res->code != 200) {
  die "Failed to fetch subscriber preferences: ".$res->
>decoded_content."\n";
}
my $prefs = JSON::from_json($res->decoded_content);
delete $prefs->{_links}; # not needed in update

$prefs->{prepaid_library} = 'libswrate';
$prefs->{block_in_clir} = JSON::true; # reject incoming anonymous calls
$prefs->{block_in_list} = [ # reject calls from the following numbers:
```

```

    '4366412345', # this particular number
    '431*', # all vienna/austria numbers
];
$req = HTTP::Request->new('PUT',
"$uri/api/subscriberpreferences/$subscriber_id");
$req->header('Content-Type' => 'application/json');
$req->header('Prefer' => "return=minimal"); # use return=representation
to get full json response
$req->content(JSON::to_json($prefs));
$res = $ua->request($req);
if($res->code != 204) {
    die "Failed to update subscriber preferences: ".$res->
    >decoded_content."\n";
}
say "Updated subscriber preferences";

```

Modifying numbers assigned to a subscriber, changing the password, locking a subscriber, etc. can be done directly on the subscriber resource.

```

$req = HTTP::Request->new('GET', "$uri/api/subscribers/$subscriber_id");
$res = $ua->request($req);
if($res->code != 200) {
    die "Failed to fetch subscriber: ".$res->decoded_content."\n";
}
my $sub = JSON::from_json($res->decoded_content);
delete $sub->{_links}; # not needed in update
push @{$sub->{alias_numbers}}, { cc => 1, ac => 5432, sn => $t }; #
add this number
push @{$sub->{alias_numbers}}, { cc => 1, ac => 5433, sn => $t }; #
add another number

$req = HTTP::Request->new('PUT', "$uri/api/subscribers/$subscriber_id");
$req->header('Content-Type' => 'application/json');
$req->header('Prefer' => "return=minimal"); # use return=representation
to get full json response
$req->content(JSON::to_json($sub));
$res = $ua->request($req);
if($res->code != 204) {
    die "Failed to update subscriber: ".$res->decoded_content."\n";
}
say "Updated subscriber";

```

At the end of a subscriber life cycle, it can be terminated. Once terminated, you can NOT recover the subscriber anymore.

```

$req = HTTP::Request->new('DELETE',
"$uri/api/subscribers/$subscriber_id");
$res = $ua->request($req);
if($res->code != 204) {

```

```

    die "Failed to terminate subscriber: ".$res->decoded_content."\n";
}
say "Terminated subscriber";

```

Note that certain information is still available in the internal database to perform billing/rating of calls done by this subscriber. Nevertheless, the data is removed from the operational tables of the database, so the subscriber is not able to connect to the system, login or make calls/chats.

Resources modification can be done via the GET/PUT combination. Alternatively, you can add, modify or delete single properties of a resource without actually fetching the whole resource. See an example below where we terminate the status of a customer using the PATCH method.

```

$req = HTTP::Request->new('PATCH', "$uri/api/customers/$customer_id");
$req->header('Content-Type' => 'application/json-patch+json');
$req->header('Prefer' => "return=minimal"); # use return=representation
to get full json response
$req->content(JSON::to_json([
    { op => 'replace', path => '/status', value => 'terminated' }
]));
$res = $ua->request($req); # this will also terminate all still active
subscribers
if($res->code != 204) {
    die "Failed to terminate customer: ".$res->decoded_content."\n";
}
say "Terminated customer";

```

## 17.2. API performance considerations

The REST API is designed with pagination support built-in. It is mandatory, to implement pagination in your API clients. If you circumvent pagination by setting the number of rows requested in one API call to a very high number the following side effects may appear:

1. An HTTP timeout at the gateway may occur. The default timeout limit is set to 60s. You can change it by creating a patchtt file for the following template: */etc/ngcp-config/templates/etc/nginx/sites-available/ngcp-panel\_admin\_api.tt2*.
2. Other parts of the system might become unresponsive due to mysql table locks. This especially applies to endpoints related to the Customers entity.

# Appendix

## Appendix A: Corosync/Pacemaker

The Corosync/Pacemaker pair forms the basis of the High Availability stack in Sipwise C5.

Corosync plays the role of the **Group Communication System** (GCS) and is in charge of communication, while Pacemaker sits on top of the GCS and plays the role of the **Cluster Resource Manager** (CRM), managing the resources and responding to changes in the cluster status.

### Corosync

Corosync is the **Group Communication System** (GCS). Its configuration resides in `/etc/corosync/corosync.conf` and describes the following details:

- Shared cluster name of `sp`
- Quorum config as a two-node cluster (see below)
- Config details for both nodes:

Name (`sp1` and `sp2`, or `a` and `b` node names)

Node ID (`1` and `2` respectively)

Local IP address for communication

### Quorum

Corosync uses a voting system to determine the state of the cluster. Each configured node in the cluster receives one vote. A quorum is defined as a majority presence within the cluster, meaning at least 50% of the configured nodes plus one, or  $q = n / 2 + 1$ . For example, if 8 nodes were configured, a quorum would be present if at least 5 nodes are communicating with each other. In this state, the cluster is said to be quorate, which means it can operate normally. (Any remaining nodes, 3 in the worst case, would see the cluster as inquorate and would relinquish all their resources.)

A two-node cluster is a special case as under the formula above, a quorum would consist of 2 functioning nodes. The Corosync config setting `two_node: 1` overrides this and artificially sets the quorum to 1. This means that under a split-brain scenario (each node seeing only 1 vote), both nodes would see the cluster as quorate and try to become active, instead of both nodes going standby.

In addition to this, Pacemaker itself also uses an internal scoring system for individual resources. This mechanism is described below and not directly related to the quorum.

### Pacemaker

Pacemaker uses the communication service provided by Corosync to manage local resources. All status and configuration information is shared between all Pacemaker instances within the cluster as long as communication is up. This means that any configuration change done on any node will immediately and automatically be propagated to all other nodes in the cluster.

Pacemaker internally uses an XML document to store its configuration, called "CIB" stored in `/var/lib/pacemaker/cib/cib.xml`. However, this XML document **must never** be edited or modified directly. Instead, a shell-like interface `crm` is provided to talk to Pacemaker, query status information, alter cluster state, view and modify configuration, etc. Any configuration change done through `crm` is immediately reflected in the CIB XML, locally as well as on all other nodes.

**WARNING** | To repeat, do not ever directly modify Pacemaker's XML configuration.

As an added bonus, to make things more awkward, the syntax used by `crm` is not XML at all, but rather uses a Cisco-like hierarchy.

Commands can be issued to `crm` either directly from the shell as command-line arguments, or interactively by entering a Cisco-like shell. So for example, the current config can be viewed either from the shell with:

```
root@sp1:~# crm configure show
...
```

Or interactively, as either:

```
root@sp1:~# crm
crm(live/sp1)# config
crm(live/sp1)configure# show
...
```

or

```
root@sp1:~# crm
crm(live/sp1)# configure show
...
```

Interactive online help is provided by the `ls` command to list commands valid in the current context, or using the `help` command for a more verbose help output.

## Query Status

The current cluster status can be viewed with the top-level `status` command:

```
crm(live/sp1)# status
Status of pacemakerd: 'Pacemaker is running' (last updated 2024-05-13
19:40:17 +02:00)
Cluster Summary:
* Stack: corosync
* Current DC: sp1 (version 2.1.5-a3f44794f94) - partition with quorum
* Last updated: Mon May 13 19:40:17 2024
* Last change: Mon May 13 01:51:46 2024 by hacluster via crmd on sp1
* 2 nodes configured
* 8 resource instances configured
```

```
Node List:
* Online: [ sp1 sp2 ]
```

**Full List of Resources:**

```

* p_monit_services (ocf:ngcp:monit-services):      Started sp1
* Resource Group: g_vips:
  * p_vip_neth1_v4_1 (ocf:heartbeat:IPaddr2):      Started sp1
* Clone Set: c_ping [p_ping]:
  * Started: [ sp1 sp2 ]
* Clone Set: fence-sp1 [st-sp1]:
  * Started: [ sp1 sp2 ]
* Clone Set: fence-sp2 [st-sp2]:
  * Started: [ sp1 sp2 ]

```

If the status is queried from **sp2** instead, the output will be the same. Most importantly, the resources will **not** show up as "stopped" on **sp2** but instead will be reported as running on **sp1**.

The resources reported are described in the configuration section below.

## Config Management

The NGCP templates do not operate on Pacemaker's CIB XML directly, but instead produce a file in CRM syntax in `/etc/pacemaker/cluster.crm`. This file is not handled by Pacemaker directly, but instead is loaded into Pacemaker via the `crm` command `configure load replace`. It shouldn't be necessary to do this manually, as the script `ngcp-ha-crm-reload` handles this automatically, which is called from the config file's postbuild script.

Changes to the config don't need to be saved explicitly. This is done automatically by Pacemaker, as well as sharing any changes with all other members of the cluster.

In `crm`, changes made to the config are cached until made active with `commit`, or discarded with `refresh`. Changes to resource status can be avoided by enabling maintenance mode (see below).

### IMPORTANT

However, since our config is loaded from a template, any changes done to the config through `crm` manually are transient and will be lost the next time a config reload happens.

The currently active config can be shown with `configure show` and should be logically identical to the contents of `/etc/pacemaker/cluster.crm`:

```

crm(live/sp1)# configure show
node 1: sp1
node 2: sp2
primitive p_monit_services ocf:ngcp:monit-services \
  meta migration-threshold=20 \
  meta failure-timeout=30 \
  op stop timeout=120 interval=0 \
  op monitor interval=20 timeout=60 on-fail=restart \
  op_params start_interval=0
primitive p_ping ocf:ngcp:ping \
  params host_list="198.51.100.1 203.0.113.1" multiplier=1000
dampen=5s debug=1 \
  meta failure-timeout=800 \

```

```

op monitor interval=10 timeout=60 on-fail=restart \
op_params start start_interval=0
primitive p_vip_neth1_v4_1 IPAddr2 \
params ip=203.0.113.250 nic=neth1 cidr_netmask=29 \
op monitor interval=5 timeout=60 on-fail=restart \
op_params start start_interval=0
primitive st-sp1 stonith:fence_ngcp \
params ipaddr=sp1 passwd="*****" pcmk_delay_base=5
pcmk_delay_max=30 pcmk_host_check=static-list pcmk_host_list=sp1
primitive st-sp2 stonith:fence_ngcp \
params ipaddr=sp2 passwd="*****" pcmk_delay_base=5
pcmk_delay_max=30 pcmk_host_check=static-list pcmk_host_list=sp2
group g_vips p_vip_neth1_v4_1
clone c_ping p_ping
clone fence-sp1 st-sp1
clone fence-sp2 st-sp2
location l_p_monit_services p_monit_services \
rule pingd: defined pingd
colocation l_vip_with_p_monit_services inf: g_vips p_monit_services
location l_vips g_vips \
rule pingd: defined pingd
order o_vip_then_p_monit_services Mandatory: g_vips p_monit_services
property cib-bootstrap-options: \
have-watchdog=false \
cluster-infrastructure=corosync \
cluster-name=sp \
stonith-enabled=yes \
no-quorum-policy=ignore \
cluster-recheck-interval=10 \
startup-fencing=yes \
dc-version=2.1.5-a3f44794f94
rsc_defaults rsc-options: \
resource-stickiness=100

```

## General Concepts

- The configuration consists of a collection of objects of various types with various attributes.
- Each object has a unique identifying name that can be used to refer to it.
- Usually the type of the object is the first word and the identifying name is the second. For example, `clone c_ping p_ping` defines a `clone` type object with the name `c_ping`.
- The unique name is used e.g. when deleting an object (`configure del ...`), when starting or stopping a resource, when referring to resources from a group, etc.

## Resources

Resources are the primary type of objects that Pacemaker handles. A resource is anything that can be started or stopped, and a resource is normally allowed to run on one node only. A resource is defined as a `primitive` type object.

Pacemaker supports many types of resources, all of which have different options that can be given to

them. The config syntax defines that options given to a resource itself are prefixed with **params**, while options that influence how a resource should be managed are prefixed with **meta**. Options that are relevant to operations that can be performed on a resource are prefixed with **op**.

Resources are grouped into classes, providers, and types. Details about them (e.g. which options they support) can be obtained through the **ra** menu.

```
crm(live/sp1)ra# info IPAddr2
Manages virtual IPv4 and IPv6 addresses (Linux specific version)
(ocf:heartbeat:IPAddr2)
...
```

### Shared IP Addresses

```
primitive p_vip_neth1_v4_1 IPAddr2 \
  params ip=203.0.113.250 nic=neth1 cidr_netmask=29 \
  op monitor interval=5 timeout=60 on-fail=restart \
  op_params start_interval=0
```

This defines a resource of type **IPAddr2** with name **p\_vip\_eth1\_v4\_1** and the given parameters (address, netmask, interface). Pacemaker will check for the existence of the address every 5 seconds, with an action timeout of 60 seconds. If the monitor action fails, the resource is restarted.

### System Services

```
primitive p_monit_services ocf:ngcp:monit-services \
  meta migration-threshold=20 \
  meta failure-timeout=30 \
  op stop timeout=120 interval=0 \
  op monitor interval=20 timeout=60 on-fail=restart \
  op_params start_interval=0
```

While Pacemaker has support for native systemd services, for the time being we're still relying on **monit** to manage our services. Therefore, services are managed using the **monit-services** OCF resources with its start/stop actions. The script for this OCF resource is located at **/etc/ngcp-ocf/monit-services**.

#### NOTE

The **monit-services** OCF resource can optionally implement a **monitor** action, which can be configured via the **config.yml** variable **ha.monitor\_services**. It can be set to 'full' to periodically use the output of **ngcp-service summary** to determine whether all services are running or not. The default value is 'none', which preserves backwards compatibility with the previous behavior, by performing no periodic checks of the status of the services.

- **meta migration-threshold=20** means that the resource will be migrated away (instead of restarted) after 20 failures. See the discussion on failure counts below.
- **meta failure-timeout=800** means that the failure count should be reset to zero if the last failure occurred more than 800 seconds ago. (However, the actual timer depends on the **cluster-**

`recheck-interval`.)

- Run the monitor action every 20 seconds with a timeout of 60 seconds and restart the resource on failure.

### Ping Nodes

```
primitive p_ping ocf:ngcp:ping \
    params host_list="198.51.100.1 203.0.113.1" multiplier=1000
dampen=5s debug=1 \
    meta failure-timeout=800 \
    op monitor interval=10 timeout=60 on-fail=restart \
    op_params start start_interval=0
```

The builtin `pingd` service, using a resource name that intelligently is not named `pingd` but rather `ping` implements the ping nodes support. It supports multiple ping backends, and uses `fping` by default.

Each configured ping node (each entry in `host_list`) produces a score of 1 if that ping node is up. The scores are summed up and multiplied by the `multiplier`. So in the example above, a score of 2000 is generated if both ping nodes are up. Pacemaker will then prefer the node which produces the higher score.

- `dampen=5s` means to wait 5 seconds after a change occurred to prevent transient glitches from causing service flapping.
- Other options are the same as described above.

### Fencing/STONITH

```
primitive st-sp1 stonith:fence_ngcp \
    params ipaddr=sp1 passwd="*****" pcmk_delay_base=5
pcmk_delay_max=30 pcmk_host_check=static-list pcmk_host_list=sp1
primitive st-sp2 stonith:fence_ngcp \
    params ipaddr=sp2 passwd="*****" pcmk_delay_base=5
pcmk_delay_max=30 pcmk_host_check=static-list pcmk_host_list=sp2
```

Pacemaker will generate a warning if no fencing mechanism is configured, therefore we configure the `null` fencing mechanism.

Pacemaker supports several proper fencing mechanism and these might eventually get supported in the future.

### Groups

```
group g_vips p_vip_neth1_v4_1
```

To manage, control, and restrict multiple resources at the same time, resources can be grouped into single objects. The group `g_vips` ensures that all shared IP addresses are active at the same time.

## Clones

```
clone c_ping p_ping
clone fence-sp1 st-sp1
clone fence-sp2 st-sp2
```

Since a single resource normally only runs on one node, a clone can be defined to allow a resource to run on all nodes. We want the **pingd** service and the fencing service to always run on all nodes.

## Constraints

```
colocation l_vip_with_p_monit_services inf: g_vips p_monit_services
```

This tells Pacemaker that we want to force the **p\_monit\_services** resource on the same node that is running the **g\_vips** resource.

```
location l_p_monit_services p_monit_services \
    rule pingd: defined pingd
location l_vips g_vips \
    rule pingd: defined pingd
```

This tells Pacemaker that these resources depend on the **pingd** service being healthy. If **pingd** fails on one node (ping nodes are unavailable), then Pacemaker will shut down the constrained resources.

```
order o_vip_then_p_monit_services Mandatory: g_vips p_monit_services
```

This tells Pacemaker that the shared IP addresses must be up and running before the system services can be started.

## Cluster Options

```
property cib-bootstrap-options: \
    have-watchdog=false \
    cluster-infrastructure=corosync \
    cluster-name=sp \
    stonith-enabled=yes \
    no-quorum-policy=ignore \
    cluster-recheck-interval=10 \
    startup-fencing=yes \
    dc-version=2.1.5-a3f44794f94
```

Relevant options are:

- **have-watchdog=false** indicates that no external watchdog service such as **SBD** is in use.
- **cluster-name=sp** is to match the configuration of Corosync.

- `stonith-enabled=yes` is required to suppress a warning message, even though no real STONITH (`null` fencing mechanism) is in use.
- `no-quorum-policy=ignore` tells Pacemaker to continue normally if quorum is lost. This is the only setting that makes sense in a two-node cluster.
- `startup-fencing=yes` is also needed to suppress a warning even though no real fencing is in use. This tells Pacemaker to shoot nodes that are not present immediately after startup.
- `maintenance-mode=false` tells Pacemaker to actually perform resource actions. If maintenance mode is enabled, Pacemaker will continue to run, but will not start or stop any services. This should be enabled before loading a new config, and then disabled afterwards. The script `ngcp-ha-crm-reload` does this.

## Failure Counts

Pacemaker keeps a failure count for each resource, which is somewhat hidden from view, but can largely influence its behaviour. Each time a service fails (either during runtime or during startup), the failure count is increased by one. If the failure count exceeds the configured `migration-threshold`, Pacemaker will cease trying to start the service and will migrate the service away to another node. In `crm status` this shows up as `stopped`.

Failure counts can be cleared automatically if the `failure-timeout` setting is configured for a resource. This timeout is counted after the last time the resource has failed, and is checked periodically according to the `cluster-recheck-interval`. In other words, a very short failure timeout won't have any effect unless the recheck interval is also very short.

### IMPORTANT

If no failure timeout is configured, any existing failure count must be cleared manually.

## Checking Failure Counts

The failure count for a resource can be checked from the shell via `crm_failcount`, for example:

```
root@sp1:~# crm_failcount -G -r p_monit_services
scope=status name=fail-count-p_monit_services value=0
```

The failure count on a different node can also be examined:

```
root@sp1:~# crm_failcount -G -r g_vips -N sp2
scope=status name=fail-count-g_vips value=0
```

The same can be done via `crm`:

```
crm(live/sp1)resource# failcount g_vips show sp1
scope=status name=fail-count-g_vips value=0
crm(live/sp1)resource# failcount c_ping show sp2
scope=status name=fail-count-c_ping value=0
```

As a shortcut, the script `ngcp-ha-show-failurecounts` is provided:

```
root@sp1:~# ngcp-ha-show-failcounts
p_vip_eth1_v4_1:
  sp1: 0
  sp2: 0
p_vip_eth2_v4_1:
  sp1: 0
  sp2: 0
p_monit_services:
  sp1: 0
  sp2: 0
```

### Clearing Failure Counts

Analogous to checking a failure count, it can be cleared using any one of these methods:

```
root@sp1:~# crm_failcount -D -r p_monit_services
Cleaned up p_monit_services on sp1
root@sp1:~# crm resource failcount p_monit_services delete sp2
Cleaned up p_monit_services on sp2
root@sp1:~# crm
crm(live/sp1)# resource
crm(live/sp1)resource# failcount c_ping delete sp1
Cleaned up p_ping:0 on sp1
Cleaned up p_ping:1 on sp1
crm(live/sp1)resource# bye
root@sp1:~# ngcp-ha-clear-failcounts
Cleaned up p_monit_services on sp2
Cleaned up p_monit_services on sp1
```

In addition, the `crm` command `resource cleanup` also resets failure counts.

### Resource Scores

Pacemaker uses an internal scoring system to determine which resources to run where. A resource will be run on the node on which it received the highest score. If a resource has a negative score, that resource will not be run at all. If a resource has the same score on multiple nodes, then the resource will be run on any one of those nodes. Scores can be calculated and acted upon through various config settings.

A score value of `infinity` (and negative infinity) to force certain states is provided, which evaluates to not infinity at all, but rather to a static value of one million. This can be used to artificially manipulate resource scores to force running a resource on a particular node, or forbid a resource from running on particular nodes.

Scores can be inspected through the `crm` command `resource scores`.

### Common Tasks

## Takeover and Standby

The commands `ngcp-make-active` and `ngcp-make-standby` work normally. Under Pacemaker, they function through the `crm` command `resource move` to create a temporary location constraint on `g_vips` with a lifetime of two minutes and the reverse NGCP host and peer names so that the nodes switch state.

### NOTE

These commands only effect the status of the running resources, and not the status of the node itself. This means that after going standby, Pacemaker will immediately be ready to take over the resources again if needed. See below for a discussion on node status.

Similarly, `ngcp-check-active` uses the output of `crm resource status g_vips` to determine whether the local node is active or not.

## Node Status (Online/Standby)

In addition to the status and location of individual resources, nodes themselves can also go into standby mode. The submenu `node` in `crm` has the relevant options.

A node in standby mode will not only give up all of its resources, but will also refuse to take them over until it's back online. Therefore, it's possible to set both nodes to standby mode and shut down all resources on both nodes.

### NOTE

A node in standby mode will still participate in GCS communications and remain visible to the rest of the cluster.

Use `crm node standby` to set the local node to standby mode. A remote node can be set to standby using e.g. `crm node standby sp2`.

By default, the standby mode remains active until it's cancelled manually (a lifetime of `forever`). Alternatively, a lifetime of `reboot` can be specified to tell Pacemaker that after the next reboot, the node should automatically come back online. Example: `crm node standby sp2 reboot`

To cancel standby mode, use `crm node online`, optionally followed by the node name.

To show the current status of all nodes, use `crm node show`. The top-level `crm status` also shows this.

## Maintenance Mode

If Pacemaker's maintenance mode is enabled, it will continue to operate normally, i.e. continue to run and monitor resources, but will refuse to stop or start any resources. This is useful to make changes to the running config, and is done automatically by `ngcp-ha-crm-reload`.

To enable and disable maintenance mode:

```
crm maintenance on
crm maintenance off
```

or using the more lower level method:

```
crm configure property maintenance-mode=true  
crm configure property maintenance-mode=false
```

### CLI Alternatives

Several of the commands available through `crm` are also available through standalone CLI tools, such as `crm_failcount`, `crm_standby`, `crm_resource`, etc. They generally have less friendly syntax and so researching them is left as an exercise to the reader.

# Appendix B: OpenVPN Setup

## Overview

To provide better and direct support to customers, the system framework manages up to two OpenVPN connections to Sipwise systems. On CARRIER, the VPN connections are handled by the MGMT nodes.

The primary VPN connection is always active (if configured) and so requires separate keys for sp1 and sp2 (or web01a and web01b on CARRIER). The secondary connection is managed as an active/standby service, which means that only the active node of the pair has the connection open and the service would be stopped and started during failover.

These two connections can be configured independently of each other.

## Configuration

The Sipwise C5 system provides templates for two OpenVPN config files located in `/etc/openvpn`, corresponding to the two managed connections. The file `ovpn.conf` is the primary (always active) VPN connection, while `vip.conf` is for the shared (active/standby) VPN connection providing the virtual IP.

Both connections require TLS certificates and key files, which must be provided by Sipwise support team. There are three files required by each VPN connection: a certificate authority (ca or bundle), a certificate (cert or crt), and a private key (key), all in PEM format.

Both connections also require configuration of a network interface in `network.yml`.

The config key `openvpn.keys_filename_template` in `config.yml` provides a single template from which all required file names can be generated. The default value is `/etc/ngcp-config/shared-files/openvpn/client/customer-%h_scep.%t`. It's possible to override this template using per-host and per-interface configuration (see below).

The template can contain the following placeholders:

- `%h`: replaced by the system host name (e.g. sp1, sp2, web01a, web01b, etc.) for the primary connection, or the string `vip` for the secondary connection.
- `%n`: replaced by the node name. Identical to `%h` for the primary connection. Replaced by a truncated version of the hostname for the secondary connection (e.g. web01).
- `%c`: replaced by the company name taken from `general.companyname`.
- `%l`: replaced by an empty string for a production system, or by the string `-lab` for a lab system (according to `general.production`).
- `%p`: replaced by the string `prod` for a production system, or by the string `lab` for a lab system (according to `general.production`).
- `%t`: replaced by the file name suffix (i.e. one of bundle, crt, or key).

Therefore the default template file name `customer-%h_scep.%t` would be translated to the following:

- `customer-sp1_scep.bundle`, `customer-sp1_scep.crt`, and `customer-sp1_scep.key` for the primary connection on sp1 of a PRO,
- `customer-sp2_scep.bundle`, `customer-sp2_scep.crt`, and `customer-sp2_scep.key` for the primary

connection on sp2 of a PRO,

- customer-web01a\_scep.bundle, customer-web01a\_scep.crt, and customer-web01a\_scep.key for the primary connection on web01a of a CARRIER,
- customer-web01b\_scep.bundle, customer-web01b\_scep.crt, and customer-web01b\_scep.key for the primary connection on web01b of a CARRIER,
- customer-vip\_scep.bundle, customer-vip\_scep.crt, and customer-vip\_scep.key for the secondary connection on both a PRO and a CARRIER.

### Primary (always active) connection

The service name for ngcp-service is openvpn. The systemd unit name is openvpn@ovpn. To enable it, set openvpn.enable to yes in config.yml, and create a VPN network interface in network.yml. The interface must be a tun type interface (usually tun0) and must be assigned the type openvpn in addition to any required network configuration. Only one interface with that role may exist for each host.

```
ngcp-network --set-interface=tun0 --type=openvpn ...
```

More complete example:

```
ngcp-network --set-interface=tun0 --type=openvpn --type=web_ext
--type=web_int --type=ssh_ext --ip=100.64.1.42 --netmask=255.255.255.255
```

Resulting in network.yml:

```
hosts:
  sp1:
    ...
  interfaces:
  - tun0
    ...
  tun0:
    ip: 100.64.1.42
    netmask: 255.255.255.255
    type:
    - openvpn
    - web_ext
    - web_int
    - ssh_ext
```

The same needs to be done for sp2 (ngcp-network --host=sp2 ...).

The config file /etc/openvpn/ovpn.conf would be created with key file names generated from the global file name template openvpn.keys\_filename\_template. These file names can be overridden using the following network.yml config keys, which are also available as options to ngcp-network:

- openvpn\_ca\_file, openvpn\_ca\_template, and openvpn\_ca\_inline: override the certificate authority (bundle) config.

- `openvpn_cert_file`, `openvpn_cert_template`, and `openvpn_cert_inline`: override the certificate (crt) config.
- `openvpn_key_file`, `openvpn_key_template`, and `openvpn_key_inline`: override the private key (key) config.
- Setting the `_file` option specifies the file name to be used verbatim.
- Setting the `_template` option specifies the file name template to be used. The same substitutions as for `openvpn.keys_filename_template` are applied, as described above.
- Setting the `_inline` option specifies the raw contents of a PEM file directly. The PEM contents would be stored directly in `network.yml`.

In case multiple settings are present, the order of precedence is: inline, file, template, and finally `openvpn.keys_filename_template` as last fallback.

Examples:

```
ngcp-network --set-interface=tun0 --openvpn-ca-file=/etc/ngcp
-config/shared-files/openvpn/client/foobar.bundle
ngcp-network --set-interface=tun0 --openvpn-cert-template=/etc/ngcp
-config/shared-files/openvpn/client/%c-%h.crt
ngcp-network --set-interface=tun0 --openvpn-key
-inline="$(</root/openvpn.key)"
```

This would be reflected in `network.yml` as:

```
sp1:
  ...
  tun0:
    ...
    openvpn_ca_file: /etc/ngcp-config/shared-
files/openvpn/client/foobar.bundle
    openvpn_cert_template: /etc/ngcp-config/shared-
files/openvpn/client/%c-%h.crt
    openvpn_key_inline: "....."
```

### Secondary (active/standby) connection

This is mostly identical to the config for the primary connection, with the following differences:

- The service name is `openvpn-vip` and the systemd unit name is `openvpn@vip`.
- The main "enable" switch in `config.yml` is `openvpn.enable_vip`.
- An additional tun interface must be created, usually `tun1`. The type assigned must be `openvpn_vip`. Again only one such interface may exist for each host.
- The generated config file is `/etc/openvpn/vip.conf`.

Examples:

```
ngcp-network --set-interface=tun1 --type=openvpn_vip ...
```

More complete example:

```
ngcp-network --set-interface=tun1 --type=openvpn_vip --type=web_ext
--type=web_int --type=ssh_ext --ip=100.64.1.43 --netmask=255.255.255.255
```

Resulting in network.yml:

```
hosts:
  sp1:
    ...
    interfaces:
    - tun1
    ...
    tun1:
      ip: 100.64.1.43
      netmask: 255.255.255.255
      type:
      - openvpn_vip
      - web_ext
      - web_int
      - ssh_ext
```

## Upgrade procedure

**WARNING** | Read this entire section carefully!

**IMPORTANT** | Read this entire section carefully!

Care must be taken when upgrading from a version that had the OpenVPN config done manually to a version that manages the OpenVPN itself. The `cfg-schema` upgrade script attempts to detect an existing installation and set the appropriate config keys. On CARRIER, this only works when the `cfg-schema` upgrade is done on the node managing the VPN connection (e.g. the web node). Otherwise, the config will come out empty.

The main "enable" switches `openvpn.enable` and `openvpn.enable_vip` are **NOT** set to yes by default or by the upgrade scripts. They **MUST** be enabled manually.

The OpenVPN certificates and keys are intended to be moved into the `ngcp-config` shared-files storage, which should help when deploying PRO and CARRIER systems as these files will not get out of sync. To accomplish this migration there is a script `'ngcp-migrate-openvpn-certs'` which needs to be executed on each node, and any error condition resolved by hand, such as same files containing different contents. The migration script is idempotent and thus supports re-execution after a previous failure.

## Appendix C: Basic Call Flows

### General Call Setup

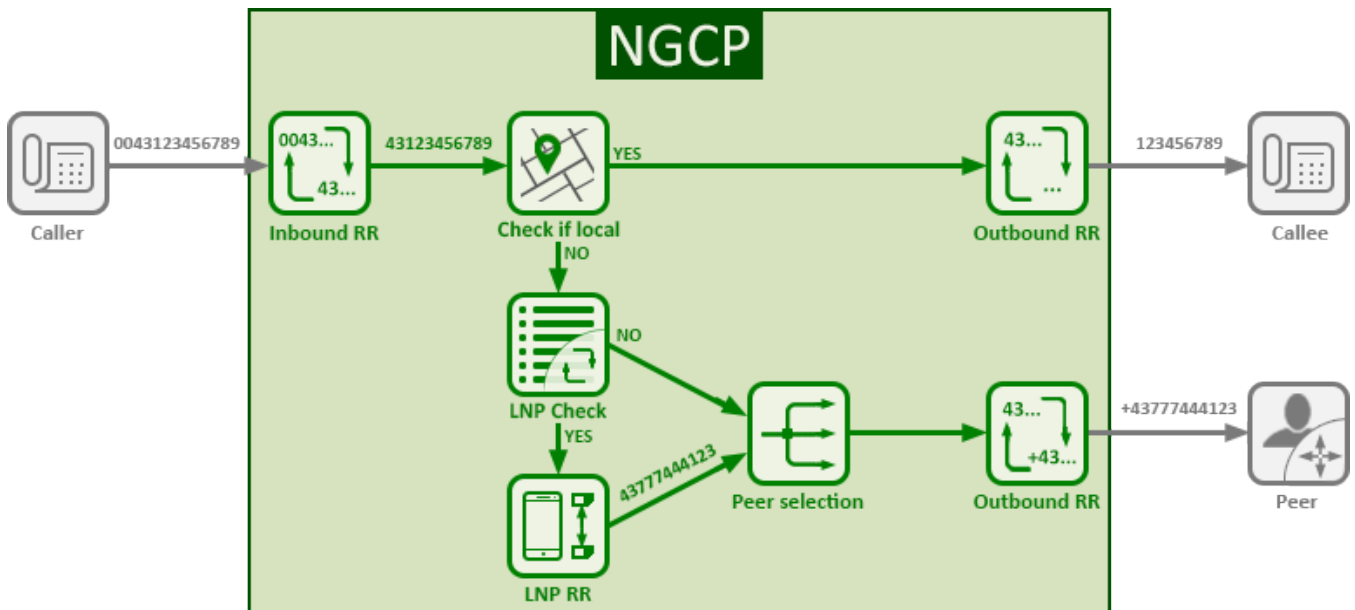

Figure 228. General Call Setup

Sipwise C5 performs the following checks when processing a call coming from a subscriber and terminated at a peer:

- Checks if the IP address where the request came from is in the list of trusted IP addresses. If yes, this IP address is taken as the identity for authentication. Otherwise, Sipwise C5 performs the digest authentication.
- When the subscriber is authorized to make the call, Sipwise C5 applies the Inbound Rewrite Rules for the caller and the callee assigned to the subscriber (if any). If there are no Rewrite Rules assigned to the subscriber, the ones assigned to the subscriber's domain are applied. On this stage the platform normalises the numbers from the subscriber's format to E.164.
- Matches the callee (called number) with local subscribers.
  - If it finds a matching subscriber, the call is routed internally. In this case, Sipwise C5 applies the Outbound Rewrite Rules associated with the callee (if any). If there are no Rewrite Rules assigned to the callee, the ones assigned to the callee's domain are applied.
  - If it does not find a matching subscriber, the call goes to a peer as described below.
- Queries the LNP database to find out if the number was ported or not. For details of LNP queries refer to the [Local Number Porting](#) chapter.
  - If it was ported, Sipwise C5 applies the LNP Rewrite Rules to the called number.
- Based on the priorities of peering groups and peering rules (see [Routing Order Selection](#) for details), Sipwise C5 selects peering groups for call termination and defines their precedence.
- Within every peering group the weight of a peering server defines its probability to receive the call for termination. Thus, the bigger the weight of a server, the higher the probability that Sipwise C5 will send the call to it.
- Applies the Outbound Rewrite Rules for the caller and the callee assigned to a peering server when

sending the call to it.

## Endpoint Registration

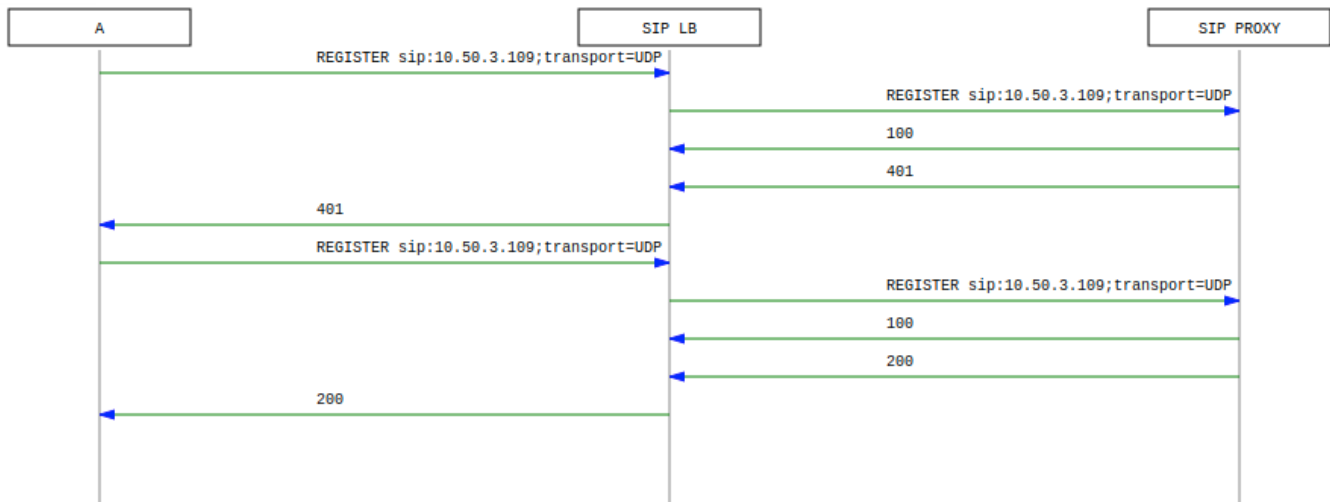

Figure 229. Registration Call-Flow

The subscriber endpoint starts sending a REGISTER request, which gets challenged by a 401. After calculating the response of the authentication challenge, it sends the REGISTER again, including the authentication response. The SIP proxy looks up the credentials of the subscriber in the database, does the same calculation, and if the result matches the one from the subscriber, the registration is granted.

The SIP proxy writes the content of the Contact header (e.g. sip:me@203.0.113.42:1234;transport=UDP) into its location table (in case of NAT the content is changed by the SIP load-balancer to the IP/port from where the request was received), so it knows where to reach a subscriber in case on an inbound call to this subscriber (e.g. sip:someuser@example.org is mapped to sip:me@203.0.113.42:1234;transport=UDP and sent out to this address).

If NAT is detected, the SIP proxy sends a OPTIONS message to the registered contact every 30 seconds, in order to keep the NAT binding on the NAT device open. Otherwise, for subsequent calls to this contact, Sipwise C5 wouldn't be able to reach the endpoint behind NAT (NAT devices usually drop a UDP binding after not receiving any traffic for ~30-60 seconds).

By default, a subscriber can register 5 contacts for an Address of Record (AoR, e.g. sip:someuser@example.org).

## Basic Call



proxy. The proxy replies with an authorization challenge in the 407 response, and the calling party sends the INVITE again with authentication credentials. The SIP proxy checks if the called party is a local user. If it is, and if there is a registered contact found for this user, then (after various feature-related tasks for both the caller and the callee) the Request-URI is replaced by the URI of the registered contact (e.g. sip:me@203.0.113.42:1234;transport=UDP). If it's not a local user but a numeric user, a proper PSTN gateway is being selected by the SIP proxy, and the Request-URI is rewritten accordingly (e.g. sip:+43123456789@203.0.113.42:5060).

Once the proxy has finished working through the call features of both parties involved and has selected the final destination for the call, and - optionally - has invoked the Media Relay for this call, the INVITE is sent to the SIP B2BUA. The B2BUA creates a new INVITE message from scratch (using a new Call-ID and a new From-Tag), copies only various and explicitly allowed SIP headers from the old message to the new one, filters out unwanted media capabilities from the SDP body (e.g. to force audio calls to use G.711 as a codec) and then sends the new message back to the SIP proxy that forwards it to the SIP load-balancer to reach to the called party.

SIP replies from the called party are passed through the elements back to the calling party (replacing various fields on the B2BUA to match the first call leg again). If a reply with an SDP body is received by the SIP proxy (e.g. a 183 or a 200), the Media Relay is invoked again to prepare the ports for the media stream.

Once the 200OK is routed from the called party to the calling party, the media stream is fully negotiated, and the endpoints can start sending traffic to each other (either end-to-end or via the Media Relay). Upon reception of the 200OK, the SIP proxy writes a start record for the accounting process. The 200OK is also acknowledged with an ACK message from the calling party to the called party, according to the SIP 3-way handshake.

Either of the parties can tear down the media session at any time by sending a BYE, which is passed through to the other party. Once the BYE reaches the SIP proxy, it instructs the Media Relay to close the media ports, and it writes a stop record for accounting purposes. Both the start- and the stop-records are picked up by the *ngcp-mediator* service in a regular interval and are converted into a Call Detail Record (CDR), which will be rated by the *ngcp-rate-o-mat* process and can be billed to the calling party. For calls made by subscribers on a prepaid plan, rating occurs at call runtime and is actually done by the B2BUA (which is necessary to properly support multiple parallel calls by the same subscriber). The final rating data is then passed on to *ngcp-rate-o-mat* which will update the CDRs accordingly.

## Session Keep-Alive

The SIP B2BUA acts as refresher for the Session-Timer mechanism as defined in RFC 4028. If the endpoints indicate support for session timers during call-setup, then the SIP B2BUA will use an UPDATE or re-INVITE message if enabled per peer, domain or subscriber via Provisioning to check if the endpoints are still alive and responsive. Both endpoints can renegotiate the timer within a configurable range. All values can be tuned using the Admin Panel or the APIs using Peer-, Domain- and Subscriber-Preferences.

### TIP

Keep in mind that the values being used in the signaling are always half the value being configured. So if you want to send a keep-alive every 300 seconds, you need to provision *sst\_expires* to 600.

If one of the endpoints doesn't respond to the keep-alive messages or answers with 481 Call/Transaction Does Not Exist, then the call is torn down on both sides. This mechanism prevents excessive over-billing of calls if one of the endpoints is not reachable anymore or "forgets" about the

call. The BYE message sent by the B2BUA triggers a stop-record for accounting and also closes the media ports on the Media Relay to stop the call.

Beside the Session-Timer mechanism to prevent calls from being lost or kept open, there is a **maximum call length** of 21600 seconds per default defined in the B2BUA. This is a security/anti-fraud mechanism to prevent overly long calls causing excessive costs.

## Voicebox Calls

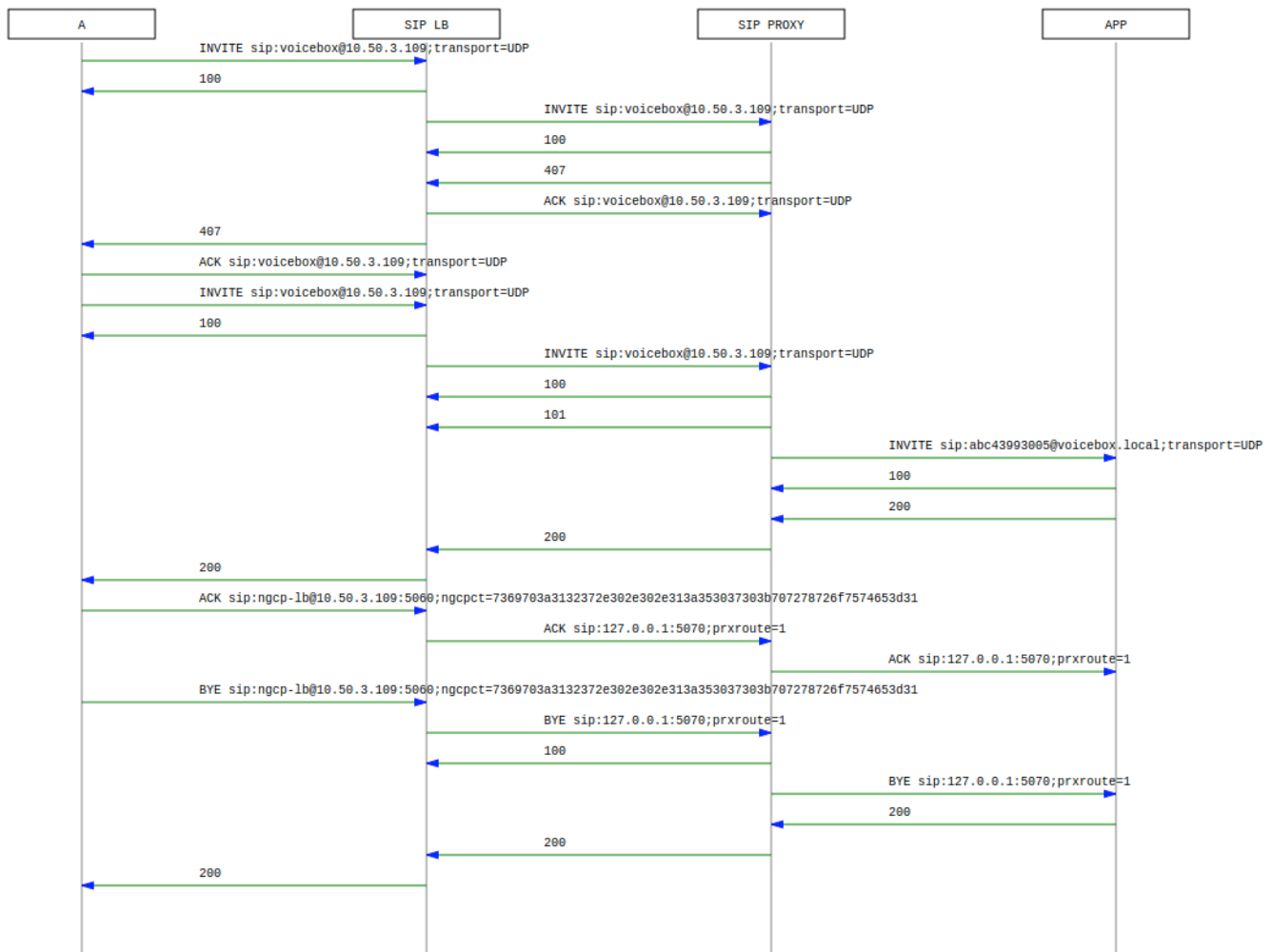

Figure 231. Voicebox Call-Flow

Calls to the Voicebox (both for callers leaving a voicemail message and for voicebox owners managing it via the IVR menu) are passed directly from the SIP proxy to the App-Server without a B2BUA. The App-Server maintains its own timers, so there is no risk of over-billing or overly long calls.

In such a case where an endpoint talks via the Media Relay to a system-internal endpoint, the Media Relay bridges the media streams between the public in the system-internal network.

In case of an endpoint leaving a new message on the voicebox, the Message-Waiting-Indication (MWI) mechanism triggers the sending of a unsolicited NOTIFY message, passing the number of new messages in the body. As soon as the voicebox owner dials into his voicebox (e.g. by calling sip:voicebox@example.org from his SIP account), another NOTIFY message is sent to his devices, resetting the number of new messages.

**IMPORTANT**

The Sipwise C5 does not require your device to subscribe to the MWI service by sending a SUBSCRIBE (it would rather reject it). On the other hand, the endpoints need to accept unsolicited NOTIFY messages (that is, a NOTIFY without a valid subscription), otherwise the MWI service will not work with these endpoints.

## Appendix D: Configuration Overview

### config.yml Overview

`/etc/ngcp-config/config.yml` is the main configuration YAML file used by Sipwise C5. After every changes it need to run the command `ngcpcfg apply "my commit message"` to apply changes (followed by `ngcpcfg push` in the PRO version to apply changes to sp2). The following is a brief description of the main variables contained into `/etc/ngcp-config/config.yml` file.

#### apps

This section contains parameters for the additional applications that may be activated on Sipwise C5.

```
apps:
  malicious_call: no
```

- `malicious_call`: If set to 'yes', the Malicious Call Identification (MCID) application will be enabled.

#### asterisk

The following is the asterisk section:

```
asterisk:
  log:
    facility: local6
  rtp:
    maxport: 20000
    minport: 10000
  sip:
    bindport: 5070
    dtmfmode: rfc2833
  voicemail:
    enable: no
    fromstring: 'Voicemail server'
    greeting:
      busy_custom_greeting: '/home/user/file_no_extension'
      busy_overwrite_default: no
      busy_overwrite_subscriber: no
      unavail_custom_greeting: '/home/user/file_no_extension'
      unavail_overwrite_default: no
      unavail_overwrite_subscriber: no
      mailbody: 'You have received a new message from ${VM_CALLERID} in
voicebox ${VM_MAILBOX} on ${VM_DATE}.'
      mailsubject: '[Voicebox] New message ${VM_MSGNUM} in voicebox
${VM_MAILBOX}'
      max_msg_length: 180
      maxgreet: 60
      maxmsg: 30
      maxsilence: 0
      min_msg_length: 3
```

```
normalize_match: '^00|\+([1-9][0-9]+)$'
normalize_replace: '$1'
serveremail: voicebox@sip.sipwise.com
```

- log.facility: rsyslog facility for asterisk log, defined in /etc/asterisk/logger.conf.
- rtp.maxport: RTP maximum port used by asterisk.
- rtp.minport: RTP minimum port used by asterisk.
- sip.bindport: SIP asterisk internal bindport.
- voicemail.greetings.\*: set the audio file path for voicemail custom unavailable/busy greetings
- voicemail.mailbody: Mail body for incoming voicemail.
- voicemail.mailsubject: Mail subject for incoming voicemail.
- voicemail.max\_msg\_length: Sets the maximum length of a voicemail message, in seconds.
- voicemail.maxgreet: Sets the maximum length of voicemail greetings, in seconds.
- voicemail.maxmsg: Sets the maximum number of messages that may be kept in any voicemail folder.
- voicemail.min\_msg\_length: Sets the minimum length of a voicemail message, in seconds.
- voicemail.maxsilence: Maxsilence defines how long Asterisk will wait for a contiguous period of silence before terminating an incoming call to voice mail. The default value is 0, which means the silence detector is disabled and the wait time is infinite.
- voicemail.serveremail: Provides the email address from which voicemail notifications should be sent.
- voicemail.normalize\_match: Regular expression to match the From number for calls to voicebox.
- voicemail.normalize\_replace: Replacement string to return, in order to match an existing voicebox.

## autoprov

The following is the autoprovisioning section:

```
autoprov:
  hardphone:
    skip_vendor_redirect: no
  server:
    bootstrap_port: 1445
    ca_certfile: '/etc/ngcp-config/shared-files/ssl/client-auth-ca.crt'
    host: localhost
    port: 1444
    server_certfile: '/etc/ngcp-config/shared-files/ssl/myserver.crt'
    server_keyfile: '/etc/ngcp-config/shared-files/ssl/myserver.key'
    ssl_enabled: yes
  softphone:
    config_lockdown: 0
    webauth: 0
```

- autoprov.skip\_vendor\_redirect: Skip phone vendor redirection to the vendor provisioning web site.

**sems-b2b (some parameters are only used with additional Cloud PBX module activated)**

The following is the B2B section:

```
b2b:
  bindport: 5080
  dialog_publish_expires: 3600
  enable: yes
  highport: 19999
  lowport: 15000
  media_processor_threads: 10
  moh_codecs:
    codecs_list: PCMA,PCMU,telephone-event
    enable: no
    mode: whitelist
  permit_ext_dial_when_no_prompt_exists: no
  session_processor_threads: 10
  xmlrpcport: 8090
```

- b2b.enable: Enable sems-b2b service.

**backuptools**

The following is the backup tools section:

```
backuptools:
  cdrexport_backup:
    enable: no
  etc_backup:
    enable: no
  mail:
    address: noc@company.org
    error_subject: '[ngcp-backup] Problems detected during daily backup'
    log_subject: '[ngcp-backup] Daily backup report'
    send_errors: no
    send_log: no
  mysql_backup:
    enable: no
    exclude_dbs: 'syslog sipstats information_schema'
  replicas:
    peer: yes
    mgmt: no
  rotate_days: 7
  storage_dir: '/ngcp-data/backup/ngcp_backup'
  temp_backup_dir: '/ngcp-data/backup/ngcp_backup/tmp'
```

- backuptools.cdrexport\_backup.enable: Enable backup of cdrexport (.csv) directory.
- backuptools.etc\_backup.enable: Enable backup of /etc/\* directory.
- backuptools.mail.address: Destination email address for backup emails.

- `backuptools.mail.error_subject`: Subject for error emails.
- `backuptools.mail.log_subjetc`: Subject for daily backup report.
- `backuptools.mail.send_error`: Send daily backup error report.
- `backuptools.mail.send_log`: Send daily backup log report.
- `backuptools.mysql_backup.enable`: Enable daily mysql backup.
- `backuptools.mysql_backup.exclude_dbs`: exclude mysql databases from backup.
- `backuptools.replicas.peer`: Enable or disable copying the backups to the peer node, for additional safety.
- `backuptools.replicas.mgmt`: Enable or disable copying the backups to the mgmt nodes, for additional safety, and so that the management nodes have consolidated backups for the entire cluster.
- `backuptools.rotate_days`: Number of days backup files should be kept. All files older than specified number of days are deleted from the storage directory.
- `backuptools.storage_dir`: Storage directory of backups.
- `backuptools.storage_group`: Name of the group that backup files should be owned by.
- `backuptools.storage_user`: Name of the user that backup files should be owned by.
- `backuptools.temp_backup_dir`: Temporary storage directory of backups.

## bootenv

The following is the bootenv section:

```
bootenv:
  custom_repos:
    - enable: no
      name: my-example-repo
      url: https://example.com/debian
    - enable: yes
      name: my-example-repo2
      url: https://example.com/debian-security
  dhcp:
    boot: '/srv/tftp/pxelinux.0'
    enable: yes
    addr_range:
      end: 192.168.1.199
      lease: 12h
      start: 192.168.1.101
    uefiboot: /srv/tftp/ipxe.efi
  http_port: 3000
  http_proxy: ''
  https_proxy: ''
  netscript:
    debug: yes
    fallbackfssize: 10G
    pxebootoption: ''
    rootfssize: 10G
```

```

swapfilesize: 2048M
ppa: []
ro_port: 9998
rw_port: 9999
tftp:
  enable: yes
  root: '/srv/tftp'

```

- bootenv.custom\_repo: The list of custom apt repos in approx
- bootenv.custom\_repo.0.enable: The flag to enable/disable the repo
- bootenv.custom\_repo.0.name: The approx name for the repo
- bootenv.custom\_repo.0.url: The approx URL for the repo
- bootenv.dhcp.enable: enable dnsmasq DHCP server
- bootenv.dhcp.boot: PXE image boot location
- bootenv.dhcp.addr\_range.start: first IP of DHCP scope
- bootenv.dhcp.addr\_range.end: last IP of DHCP scope
- bootenv.dhcp.addr\_range.lease: DHCP lease expiration time
- bootenv.dhcp.uefiboot: The location of the UEFI boot file
- bootenv.http\_port: HTTP port for iPXE boot files/configs
- bootenv.http\_proxy: HTTP proxy to access Sipwise Debian repositories
- bootenv.https\_proxy: HTTPS proxy to access Sipwise Debian repositories
- bootenv.netscript: The section for netscript (installer) options
- bootenv.netscript.debug: The flag to enable debug for iPXE boot/installer
- bootenv.netscript.fallbackfssize: The size of 'fallback' partition created by netscript (installer)
- bootenv.netscript.pxebootoption: The list of a custom iPXE boot options for netscript (installer)
- bootenv.netscript.rootfssize: The size of 'root' partition created by netscript (installer)
- bootenv.netscript.swapfilesize: The size of a swapfile created by netscript (installer)
- bootenv.ppa: The list of a custom NGCP PPA repositories (automatically filled by the tool 'ngcp-ppa')
- bootenv.ppa.0.name: The name of a custom NGCP PPA repositories
- bootenv.ppa.0.priority: The priority of a custom NGCP PPA repositories (optional)
- bootenv.ppa.0.url: The URL of a custom NGCP PPA repositories (optional)
- bootenv.ro\_port: HTTP port for read-only access to Approx cache
- bootenv.rw\_port: HTTP port for read-write access to Approx cache
- bootenv.tftp.enable: enable tftp server for PXE boot
- bootenv.tftp.root: root folder for tftp server

## cdrexpport

The following is the cdrexpport section:

```

cdrexport:
  default:
    admin_export_fields:
      - ...
    csv_esc: \
    csv_footer: ${checksum}
    csv_header: ${version},${rows,%04i}
    csv_sep: ','
    daily_folder: yes
    dir_reseller_time: no
    enable: yes
    export_conditions:
      - ...
    export_failed: no
    export_incoming: no
    export_joins:
      - ...
    export_nodes:
      hosts:
      roles:
        - mgmt
    exportpath: /home/jail/home/cdreexport
    full_names: yes
    intermediate: no
    max_rows_per_file: '5000'
    monthly_folder: yes
    reseller_export_fields:
      - ...
    write_empty: yes
  my_cdr_stream:
    admin_export_fields:
      - ...

```

- `cdrexport.<stream name>`: Each CDR export configuration is entitled as "stream" (default, `my_cdr_stream`, ...).
- `cdrexport.<stream name>.enable`: Enable or disable this cdr export stream.
- `cdrexport.<stream name>.export_nodes.roles`: Specify the node roles where to export CDRs.
- `cdrexport.<stream name>.export_nodes.hosts`: Specify the node hosts where to export CDRs.
- `cdrexport.<stream name>.csv_sep`: Specify the separator for exported CDRs in CSV format.
- `cdrexport.<stream name>.csv_esc`: Specify escape symbol to use for the separator in field values
- `cdrexport.<stream name>.csv_header`: header line in files
- `cdrexport.<stream name>.csv_footer`: footer line in files
- `cdrexport.<stream name>.daily_folder`: Specify whether or not a daily folder should be created.
- `cdrexport.<stream name>.export_failed`: Specify whether or not failed calls should be exported.
- `cdrexport.<stream name>.export_incoming`: Specify whether or not incoming calls should be exported.

- `cdrexport.<stream name>.intermediate`: Specify whether or not intermediate CDRs should be exported.
- `cdrexport.<stream name>.exportpath`: Specify the export path for CDR files.
- `cdrexport.<stream name>.full_names`: Specify whether or not to use the full name for CDR files instead of short ones.
- `cdrexport.<stream name>.monthly_folder`: Specify whether or not the system should create a monthly folder (e.g. folder '201801' for January 2018) for CDRs under the configured path.
- `cdrexport.<stream name>.dir_reseller_time`: Apply the reseller timezone for dates in daily/monthly folder names
- `cdrexport.<stream name>.files_owner`: Specify user name for created files (default: `cdrexport`).
- `cdrexport.<stream name>.files_group`: Specify group name for created files (default: `cdrexport`).
- `cdrexport.<stream name>.files_mask`: Specify the file permission mask for created files (default: `022`).
- `cdrexport.<stream name>.resellers`: List of reseller names (including 'system' reseller) to write files for.
- `cdrexport.<stream name>.write_empty`: Specify whether or not to write files with 0 records for reseller/peers w/o activity.
- `cdrexport.<stream name>.max_rows_per_file`: Specify how many rows you can store in one single CSV file.
- `cdrexport.<stream name>.admin_export_fields`: Exported field list for the system administrator user.
- `cdrexport.<stream name>.reseller_export_fields`: Exported field list for the system resellers.
- `cdrexport.<stream name>.export_joins`: SQL joined tables
- `cdrexport.<stream name>.export_conditions`: SQL filter conditions

### cdr-exporter

The following is the `cdr-exporter` section:

```
bulk_processor:
  cdr_exporter:
    enable: yes
    streams:
      postgresql_teststream:
        type: postgresql
        blocksize: 1000
        limit: 5000
        multithreading: yes
        numofthreads: 2
        table_fields:
          - path: rating_status
            colname: column1
          - path: update_time
            colname: column2
          - path: id
            colname: column3
        tablename: table_to_sync
```

```
schemaname: test
username: postgres
password: postgres
host: 192.168.0.85
port:
txn_per_cdr: no
ignore_unique: no
multi_row_insert: yes
oracle_teststream:
type: oracle
blocksize: 1000
limit: 5000
multithreading: yes
numofthreads: 2
table_fields:
  - path: rating_status
    colname: column1
  - path: update_time
    colname: column2
  - path: id
    colname: column3
tablename: TABLE_TO_SYNC
servicename: XE
host: 192.168.0.85
schemaname: TEST
username: SYSTEM
password: oracle
port:
txn_per_cdr: no
ignore_unique: no
multi_row_insert: no # not supported for oracle
mssql_teststream:
type: mssqlserver
blocksize: 100
limit: 1000
multithreading: yes
numofthreads: 2
table_fields:
  - path: rating_status
    colname: column1
  - path: update_time
    colname: column2
  - path: id
    colname: column3
tablename: table_to_sync
databasename: test
host: 192.168.0.85
username: sa
password: 123
port:
txn_per_cdr: no
ignore_unique: no
```

```

    multi_row_insert: yes
mysql_teststream:
  type: mysql
  blocksize: 1000
  limit: 5000
  multithreading: yes
  numofthreads: 2
  table_fields:
    - path: rating_status
      colname: column1
    - path: update_time
      colname: column2
    - path: id
      colname: column3
  cdrs_export_status: |
    function(record) {
      return [[ record.id, "ok" ], [ (record.id * 1) + 2, "ok" ]];
    }
  tablename: table_to_sync
  databasename: test
  username: root
  password:
  host: 192.168.5.133
  port:
  txn_per_cdr: no
  ignore_unique: no
  multi_row_insert: yes
sqlite_teststream:
  type: sqlite
  blocksize: 1000
  limit: 5000
  multithreading: yes
  numofthreads: 2
  table_fields:
    - path: rating_status
      colname: column1
    - path: update_time
      colname: column2
    - path: id
      colname: column3
  tablename: table_to_sync
  txn_per_cdr: no
  ignore_unique: no
  multi_row_insert: yes
  file_path: /home/jail/home/cdrexpert/cdrexpert.db
...

```

- `bulk_processor.cdr_exporterd.enable`: Enable or disable the `ngcp-cdr-exporterd` CDR replication daemon.
- `bulk_processor.cdr_exporterd.streams.<stream name>`: Each CDR replication configuration is entitled as "stream" (`postgresql_teststream`, `oracle_teststream`, ...).

- `bulk_processor.cdr_exporterd.streams.<stream name>.enable`: Enable or disable this cdr replication stream.
- `bulk_processor.cdr_exporterd.streams.<stream name>.type`: Specify the target file or database type (mysql, mariadb, postgres, postgresql, oracle, sqlite, sqlserver, mssql, mssqlserver).
- `bulk_processor.cdr_exporterd.streams.<stream name>.blocksize`: Specify the page size when fetching (processing) records.
- `bulk_processor.cdr_exporterd.streams.<stream name>.multithreading`: no: read from NGCP CDR source table and write to target table/file in a single thread; yes: one thread to read from source and one or more threads to write to target.
- `bulk_processor.cdr_exporterd.streams.<stream name>.numofthreads`: Number of threads to write to target in case of multithreading: yes.
- `bulk_processor.cdr_exporterd.streams.<stream name>.limit`: The exporter process restarts (with clean memory, or new target file etc.) once the given limit is exceeded (or no more unexported CDRs left).
- `bulk_processor.cdr_exporterd.streams.<stream name>.paging_txn`: yes: fetch all unexported CDRs at once (make sure to set 'limit'), and load relations in same transaction; no: fetch record pages by individual SQL queries, using OFFSET and LIMIT.
- `bulk_processor.cdr_exporterd.streams.<stream name>.export_joins`: Definition of JOINS for the SQL page queries to fetch unexported CDR records. Same as `cdrexport.<stream name>.export_joins`.
- `bulk_processor.cdr_exporterd.streams.<stream name>.export_conditions`: Definition of additional WHERE criteria for the SQL page queries to fetch unexported CDR records. Same as `cdrexport.<stream name>.export_conditions`.
- `bulk_processor.cdr_exporterd.streams.<stream name>.relations`: Definition of related data of CDR records to gather for export. Each relation is identified by a dot path notation (similar to SQL), beginning with 'cdr' as the root element. The element value can be a true value to include (load) the relation records (and it's sub elements), or a specify detailed options how to construct the CDR graph to process.
- `bulk_processor.cdr_exporterd.streams.<stream name>.expand_cdrs`: Specify a perl sub or javascript function that takes the CDR graph hash obj as input argument and is expected to return an array of CDR graphs. This can be used to expand/split a CDR into more CDRs.
- `bulk_processor.cdr_exporterd.streams.<stream name>.cdrs_export_status`: Specify a static export status ('unexported','ok','failed', 'skipped') value to set for processed CDRs, OR a perl sub or javascript function that takes a hash obj with (cdr\_id, call\_id, start\_time) key fields of the processed CDR as input argument and is expected to return an array of (cdr\_id, export\_status) tuples to commit. This can be used to skip selected CDRs, effectively collapsing (related) CDRs into one.
- `bulk_processor.cdr_exporterd.streams.<stream name>.table_fields`: List of exported fields for tabular targets (database table, .csv, .xls, ...).
- `bulk_processor.cdr_exporterd.streams.<stream name>.graph_fields`: List of field glob patterns to filter the CDR graph object when exporting file formats with graph structure (.json, .xml, ...).
- `bulk_processor.cdr_exporterd.streams.<stream name>.graph_fields_mode`: Consider 'graph\_fields' glob patterns as whitelist (include matching paths) or blacklist (exclude matching paths).
- `bulk_processor.cdr_exporterd.streams.<stream name>.tablename`: Target table name. It will be created using columns of TEXT data type supported by the remote RDBMS, if it does not exist yet.
- `bulk_processor.cdr_exporterd.streams.<stream name>.databasename`: Target database name (oracle, mssqlserver, mysql, mariadb).

- `bulk_processor.cdr_exporter.d.streams.<stream name>.servicename`: Target database servicename (oracle).
- `bulk_processor.cdr_exporter.d.streams.<stream name>.sid`: Target database SID (oracle).
- `bulk_processor.cdr_exporter.d.streams.<stream name>.schemaname`: Target database schema name (oracle, postgres).
- `bulk_processor.cdr_exporter.d.streams.<stream name>.username`: Target database credentials.
- `bulk_processor.cdr_exporter.d.streams.<stream name>.password`: Target database credentials.
- `bulk_processor.cdr_exporter.d.streams.<stream name>.host`: Target database IP address.
- `bulk_processor.cdr_exporter.d.streams.<stream name>.port`: Target database TCP port.
- `bulk_processor.cdr_exporter.d.streams.<stream name>.txn_per_cdr`: Commit exported CDRs on by one or blockwise (see 'blocksize'). Enable this if there is a frequent chance of failures (ie. from constraints or rowlocks) when committing to the target database, and avoid rolling back large blocks.
- `bulk_processor.cdr_exporter.d.streams.<stream name>.ignore_unique`: Ignore (skip) unique constraint violations when committing to the target db. Note this is not yet supported for all target database types.
- `bulk_processor.cdr_exporter.d.streams.<stream name>.file_path`: Output file path pattern, e.g. for SQLite target database.
- `bulk_processor.cdr_exporter.d.streams.<stream name>.multi_row_insert`: Use SQL INSERT statements with multiple rows to speed up committing to target db. Will be in effect only with `txn_per_cdr: no`.

## cleanuptools

The following is the cleanup tools section:

```
cleanuptools:
  acc_cleanup_days: 90
  archive_targetdir: '/ngcp-data/backups/cdr'
  binlog_days: 15
  cdr_archive_months: 2
  cdr_keep_months: 2
  compress: gzip
  delete_old_cdr_files:
    enable: no
    max_age_days: 30
    paths:
      -
        max_age_days: ~
        path: '/home/jail/home/*/20[0-9][0-9][0-9][0-9]/[0-9][0-9]'
        remove_empty_directories: yes
        wildcard: yes
      -
        max_age_days: ~
        path: '/home/jail/home/cdrexpert/resellers/*/20[0-9][0-9][0-9][0-9]/[0-9][0-9]'
        remove_empty_directories: yes
```

```

wildcard: yes
-
  max_age_days: ~
  path: '/home/jail/home/cdreexport/system/20[0-9][0-9][0-9][0-9]/[0-9][0-9]'
  remove_empty_directories: yes
  wildcard: yes
sql_batch: 10000
trash_cleanup_days: 30

```

- `cleantools.acc_cleanup_days`: CDR records in acc table in kamailio database will be deleted after this time
- `cleantools.binlog_days`: Time after MySQL binlogs will be deleted.
- `cleantools.cdr_keep_months`: Specify how many months of CDRs to keep in the main table (visible to call lists). Only relevant with `cdr_cleanup_mode`: 'backup'.
- `cleantools.cdr_archive_months`: Specify how many months worth of records to keep in monthly CDR backup tables instead of dumping them into archive files (under '`cleantools.archive_targetdir`' folder) and dropping them from database. Only relevant with `cdr_cleanup_mode`: 'backup'.
- `cleantools.cdr_keep_days`: Specify how many days of CDRs to keep in the main table (visible to call lists). Only relevant with `cdr_cleanup_mode`: 'cleanup'.
- `cleantools.cdr_cleanup_mode`: 'cleanup' will **delete** CDRs older than `cdr_keep_days`. 'backup' will move and archive CDRs older than `cdr_keep_months`.
- `cleantools.fax_keep_months`: Specify how many months of faxes to keep in the fax journal. Only relevant with `fax_cleanup_mode`: 'backup'.
- `cleantools.fax_archive_months`: Specify how many months worth of records to keep in monthly fax backup tables instead of dumping them into archive files (under '`cleantools.archive_targetdir`' folder) and dropping them from database. Only relevant with `fax_cleanup_mode`: 'backup'.
- `cleantools.fax_keep_days`: Specify how many days of faxes to keep in the fax journal. Only relevant with `fax_cleanup_mode`: 'cleanup'.
- `cleantools.fax_cleanup_mode`: 'cleanup' will **delete** faxes older than `fax_keep_days`. 'backup' will move and archive faxes older than `fax_keep_months`.
- `cleantools.delete_old_cdr_files`:

enable: Enable (**yes**) or disable (**no**) exported CDR cleanup.

`max_age_days`: Gives the expiration time of the exported CDR files in days. There is a general value which may be overridden by a local value provided at a specific path. The local value is valid for the particular path only.

`paths`: an array of path definitions

path: a path where CDR files are to be found and deleted; this may contain wildcard characters

wildcard: Enable (**yes**) or disable (**no**) using wildcards in the path

`remove_empty_directories`: Enable (**yes**) or disable (**no**) removing empty directories if those are found in the given path

`max_age_days`: the local expiration time value for files in the particular path

- `cleanuptools.sql_batch`: How many records to process within a single SQL statement.
- `cleanuptools.trash_cleanup_days`: Time after CDRs from `acc_trash` and `acc_backup` tables in kamailio database will be deleted.

For the description of *cleanuptools* please visit [Cleanuptools Description](#) section of the handbook.

## cluster\_sets

The following is the cluster sets section:

```
cluster_sets:
  default:
    dispatcher_id: 50
  default_set: default
  type: central
```

- `cluster_sets.<label>`: an arbitrary label of the cluster set; in the above example we have `default`
- `cluster_sets.<label>.dispatcher_id`: a unique, numeric value that identifies a particular cluster set
- `cluster_sets.default_set`: selects the default cluster set
- `cluster_sets.type`: the type of cluster set; can be `central` or `distributed`

## cron

The following is the cron section:

```
cron:
  crontab:
    users:
      allow: []
```

- `cron.crontab.users.allow`: Specify a list of usernames that are allowed to schedule cronjobs with `crontab(1)`. By default no user besides `root` can use `crontab(1)`.

## database

The following is the database section:

```
database:
  bufferpoolsize: 24768M
```

- `database.bufferpoolsize`: `Innodb_buffer_pool_size` value in `/etc/mysql/my.cnf`

## faxserver

The following is the fax server section:

```

faxserver:
  enable: yes
  fail_attempts: '3'
  fail_retry_secs: '60'
  mail_from: 'Sipwise C5 FaxServer <voipfax@ngcp.sipwise.local>'

```

- faxserver.enable: 'yes'/'no' to enable or disable ngcp-faxserver on the platform respectively.
- faxserver.fail\_attempts: Amount of attempts to send a fax after which it is marked as 'failed'.
- faxserver.fail\_retry\_secs: Amount of seconds to wait between "fail\_attempts".
- faxserver.mail\_from: Sets the e-mail From Header for incoming fax.

## general

The following is the general section:

```

general:
  adminmail: adjust@example.org
  companyname: sipwise
  lang: en
  production: yes
  timezone: localtime

```

- general.adminmail: Email address used by monit to send notifications to.
- general.companyname: Label used in SNMPd configuration.
- general.lang: Sets sounds language (e.g: 'de' for German)
- general.production: Label to hint self-check scripts about installation mode.
- general.timezone: Sipwise C5 Timezone

## ha

The following is the High Availability (ha) section:

```

ha:
  gcs: corosync
  crm: pacemaker
  pingnodes:
    - 10.60.1.1
    - 192.168.3.4
  pingnodes_add_gw: yes
  pingnodes_add_dns: yes
  monitor_services: none

```

- ha.crs: Group Communication System (GCS). Supported: 'corosync'.
- ha.crm: Cluster Resource Manager (CRM). Supported: 'pacemaker'.

- `ha.pingnodes`: List of HA pingnodes. Minimum 2 entries, otherwise by default Sipwise C5 will set the default gateway and DNS servers as pingnodes.
- `ha.pingnodes_add_gw`: Enable whether to add the gateway IP to the HA ping nodes list (only if less than 3 ping nodes are defined in the list already).
- `ha.pingnodes_add_dns`: Enable whether to add the DNS IPs to the HA ping nodes list (only if less than 3 ping nodes are defined in the list already).
- `ha.monitor_services`: Whether the HA system should periodically monitor the active services and take that into account as part of considering whether the node can act as the active one (only supported with 'pacemaker').

## haproxy

The following is the haproxy section:

```
haproxy:
  admin: no
  admin_port: 8080
  admin_pwd: iKNPFuPFHMCHh9dsXgVg
  enable: no
```

- `haproxy.enable`: enable haproxy

## intercept

The following is the legal intercept section:

```
intercept:
  enable: no
```

- `intercept.enable`: Enable `ngcp-voisniff` for Lawful Interception (additional Sipwise C5 module).

## kamailio

The following is the kamailio section:

```
kamailio:
  lb:
    block_useragents:
      action: reject
      block_empty: no
      block_absent: no
      enable: no
      mode: blacklist
      ua_patterns: []
  cfgt: no
  debug:
    enable: no
  modules:
```

```
- level: '1'
  name: core
- level: '3'
  name: xlog
debug_level: '1'
debug_uri:
  enable: no
  redis_db: 27
  htable_idx_size: 4
dns:
  dns_sctp_pref: 1
  dns_tcp_pref: 1
  dns_tls_pref: 1
  dns_try_naptr: no
  dns_udp_pref: 1
  use_dns_cache: on
enable: yes
external_sbc: []
extra_sockets: ~
filter_content_type:
  enable: yes
  action: filter
  content_type_list:
  - content_type: application/vnd.etsi.cug+xml
    direction: all
  - content_type: application/isup
    direction: reply
  - content_type: application/xml
    direction: request
max_forwards: '70'
mem_log: '1'
mem_summary: '12'
max_inv_lifetime: '180000'
nattest_exception_ips:
- 203.0.113.42
- 203.0.113.43
nattest_exception_nets:
- 192.168.10.0/24
- 192.168.11.0/24
pkg_mem: '16'
port: '5060'
sdp_line_filter:
  enable: no
  remove_line_startswith: []
security:
  dos_ban_enable: yes
  dos_ban_time: '300'
  dos_reqs_density_per_unit: '50'
  dos_sampling_time_unit: '5'
  dos_whitelisted_ips: []
  dos_whitelisted_subnets: []
  failed_auth_attempts: '3'
```

```

failed_auth_ban_enable: yes
failed_auth_ban_time: '3600'
failed_ip_auth_attempts: '3'
failed_ip_auth_ban_enable: no
failed_ip_auth_ban_time: '3600'
topoh:
  enable: no
  mask_callid: no
  mask_ip: 127.0.0.8
topos:
  enable: no
  redis_db: 24
shm_mem: '64'
skip_contact_alias_for_ua_when_tcp:
  enable: no
  user_agent_patterns: []
strict_routing_safe: no
syslog_options: yes
tcp_children: 1
tcp_max_connections: '2048'
tls:
  connection_timeout: 600
  domains:
    - ca_list: ''
      cipher_list:
MEDIUM:HIGH:!SSLv2:!SSLv3:!aNULL:!eNULL:!LOW:!3DES:!MD5:!EXP:!PSK:!DSS:!
RC4:!SEED:!ECDSA
      description: Default server TLS configuration for inbound
connections
      domain: default
      enable: yes
      require_certificate: no
      server_id: ''
      server_name: ''
      server_name_mode: ''
      sslcertfile: /etc/ngcp-config/shared-files/ssl/myserver.crt
      sslcertkeyfile: /etc/ngcp-config/shared-files/ssl/myserver.key
      tls_method: TLSv1.2+
      type: server
      verify_certificate: no
    - ca_list: ''
      cipher_list:
MEDIUM:HIGH:!SSLv2:!SSLv3:!aNULL:!eNULL:!LOW:!3DES:!MD5:!EXP:!PSK:!DSS:!
RC4:!SEED:!ECDSA
      description: Default client TLS configuration for outbound
connections
      domain: default
      enable: yes
      require_certificate: no
      server_id: ''
      server_name: ''
      server_name_mode: ''

```

```
    sslcertfile: /etc/ngcp-config/shared-files/ssl/myserver.crt
    sslcertkeyfile: /etc/ngcp-config/shared-files/ssl/myserver.key
    tls_method: TLSv1.2+
    type: client
    verify_certificate: no
enable: yes
init_mode: 0
port: '5061'
rand_engine: ''
static: no
udp_children: 1
proxy:
  allow_cf_to_itself: no
  allow_info_method: no
  allow_msg_method: no
  allow_peer_relay: no
  allow_refer_method: no
  always_anonymize_from_user: no
  authenticate_bye: no
  cf_depth_limit: '10'
  cftg: no
  check_prev_forwarder_as_upn: no
  children: 1
  decode_utu_header: no
  debug:
    enable: no
    modules:
      - level: '1'
        name: core
      - level: '3'
        name: xlog
  debug_level: '1'
  default_expires: '3600'
  default_expires_range: '30'
  dlg_timeout: '43200'
  early_rejects:
    block_admin:
      announce_code: '403'
      announce_reason: Blocked by Admin
    block_callee:
      announce_code: '403'
      announce_reason: Blocked by Callee
    block_caller:
      announce_code: '403'
      announce_reason: Blocked by Caller
    block_contract:
      announce_code: '403'
      announce_reason: Blocked by Contract
    block_in:
      announce_code: '403'
      announce_reason: Block in
    block_out:
```

```
announce_code: '403'  
announce_reason: Blocked out  
block_override_pin_wrong:  
announce_code: '403'  
announce_reason: Incorrect Override PIN  
callee_busy:  
announce_code: '486'  
announce_reason: Busy Here  
callee_offline:  
announce_code: '480'  
announce_reason: Offline  
callee_tmp_unavailable:  
announce_code: '480'  
announce_reason: Temporarily Unavailable  
callee_tmp_unavailable_gp:  
announce_code: '480'  
announce_reason: Unavailable  
callee_tmp_unavailable_tm:  
announce_code: '408'  
announce_reason: Request Timeout  
callee_unknown:  
announce_code: '404'  
announce_reason: Not Found  
cf_loop:  
announce_code: '480'  
announce_reason: Unavailable  
emergency_invalid:  
announce_code: '404'  
announce_reason: Emergency code not available in this region  
emergency_unsupported:  
announce_code: '403'  
announce_reason: Emergency Calls Not Supported  
invalid_speeddial:  
announce_code: '484'  
announce_reason: Speed-Dial slot empty  
locked_in:  
announce_code: '403'  
announce_reason: Callee locked  
locked_out:  
announce_code: '403'  
announce_reason: Caller locked  
max_calls_in:  
announce_code: '486'  
announce_reason: Busy  
max_calls_out:  
announce_code: '403'  
announce_reason: Maximum parallel calls exceeded  
no_credit:  
announce_code: '402'  
announce_reason: Insufficient Credit  
peering_unavailable:  
announce_code: '503'
```

```

    announce_reason: PSTN Termination Currently Unavailable
reject_vsc:
    announce_code: '403'
    announce_reason: VSC Forbidden
relaying_denied:
    announce_code: '403'
    announce_reason: Relaying Denied
unauth_caller_ip:
    announce_code: '403'
    announce_reason: Unauthorized IP detected
emergency_priorization:
    enable: no
    register_fake_200: yes
    register_fake_expires: '3600'
    reject_code: '503'
    reject_reason: Temporary Unavailable
    retry_after: '3600'
enable: yes
enum_suffix: e164.arpa.
expires_range: '30'
filter_100rel_from_supported: no
filter_failover_response: 408|500|503
foreign_domain_via_peer: no
fritzbox:
    enable: no
    prefixes:
    - 0$avp(caller_ac)
    - $avp(caller_cc)$avp(caller_ac)
    - \+$avp(caller_cc)$avp(caller_ac)
    - 00$avp(caller_cc)$avp(caller_ac)
    special_numbers:
    - '112'
    - '110'
    - 118[0-9]{2}
ignore_auth_realm: no
ignore_subscriber_allowed_clis: no
keep_original_to: no
lcr_stopper_mode: 0
latency_limit_action: '100'
latency_limit_db: '500'
latency_log_level: '1'
latency_runtime_action: 1000
lnp:
    add_reply_headers:
    enable: no
    number: P-NGCP-LNP-Number
    status: P-NGCP-LNP-Status
    api:
    add_caller_cc_to_lnp_dst: no
    invalid_lnp_routing_codes:
    - ^EE00
    - ^DD00

```

```
keepalive_interval: '3'
lnp_request_blacklist: []
lnp_request_whitelist: []
port: '8991'
reply_error_on_lnp_failure: no
request_timeout: '1000'
server: localhost
tcap_field_fci: end.components.0.invoke.parameter
tcap_field_lnp: ConnectArg.destinationRoutingAddress.0
tcap_field_opcode: end.components.0.invoke.opCode
enable: no
execute_ncos_block_out_before_lnp: no
skip_callee_lnp_lookup_from_any_peer: no
strictly_check_ncos: no
type: api
lookup_peer_destination_domain_for_pbx: no
loop_detection:
  enable: no
  expire: '1'
  max: '5'
max_expires: '43200'
max_gw_lcr: '128'
max_registrations_per_subscriber: '5'
mem_log: '1'
mem_summary: '12'
min_expires: '60'
nathelper:
  sipping_from: sip:pinger@sipwise.local
nathelper_dbro: no
natping_interval: '30'
natping_processes: 1
nonce_expire: '300'
pbx:
  hunt_display_fallback_format: '[H %s]'
  hunt_display_fallback_indicator: $var(cloud_pbx_hg_ext)
  hunt_display_format: '[H %s]'
  hunt_display_indicator: $var(cloud_pbx_hg_displayname)
  hunt_display_maxlength: 8
  ignore_cf_when_hunting: no
peer_probe:
  available_treshold: '1'
  enable: yes
  from_uri_domain: probe.ngcp.local
  from_uri_user: ping
  interval: '10'
  method: OPTIONS
  reply_codes: class=2;class=3;code=403;code=404;code=405
  timeout: '5'
  unavailable_treshold: '1'
perform_peer_failover_on_tm_timeout: yes
perform_peer_lcr: no
pkg_mem: '32'
```

```

port: '5062'
presence:
  enable: yes
  max_expires: '3600'
  reginfo_domain: example.org
proxy_lookup: no
push:
  apns_alert: New call
  apns_sound: incoming_call.xaf
  code_18x: 180
  reason_18x: 'Ringing'
  reply_18x: 'no'
report_mos: yes
set_ruri_to_peer_auth_realm: no
shm_mem: '125'
skip_pbx_loop: no
stir:
  cache_dir: /var/cache/kamailio/stir/
  cache_expire: 3600
  domains:
    - name: <domain_name>
      private_key: <path_to_a_private_key_related_to_domain>
  enable: yes
  expire: 300
  libopt: []
  shaken:
    attestation_name: verstat
    attestation_values:
      failed: TN-Validation-Failed
      no_validation: No-TN-Validation
      not_present: TN-Validation-Not-Present
      passed: TN-Validation-Passed
      passed_A: TN-Validation-Passed-A
      passed_B: TN-Validation-Passed-B
      passed_C: TN-Validation-Passed-C
  timeout: 5
store_recentcalls: no
syslog_options: yes
tcp_children: 1
tm:
  fr_inv_timer: '180000'
  fr_timer: '9000'
  max_inv_lifetime: '180000'
treat_600_as_busy: yes
use_enum: no
usrloc_dbmode: '1'
voicebox_first_caller_cli: yes
xfer_other_party_from: no

```

- kamailio.lb.block\_useragents.action: one of [**drop**, **reject**] - Whether to silently drop the request from matching User-Agent or reject with a 403 message.

- `kamailio.lb.block_useragents.block_empty`: Enable/disable a rejection of messages with an empty User-Agent header (header present, but no value given).
- `kamailio.lb.block_useragents.block_absent`: Enable/disable a rejection of messages with an absent User-Agent header.
- `kamailio.lb.block_useragents.enable`: Enable/disable the User-Agent blocking.
- `kamailio.lb.block_useragents.mode`: one of [`whitelist`, `blacklist`] - Sets the mode of `ua_patterns` list evaluation (`whitelist`: block requests coming from all but listed User-Agents, `blacklist`: block requests from all listed User-Agents).
- `kamailio.lb.block_useragents.ua_patterns`: List of User-Agent string patterns that trigger the block action.
- `kamailio.lb.cfgt`: Enable/disable unit test config file execution tracing.
- `kamailio.lb.debug.enable`: Enable per-module debug options.
- `kamailio.lb.debug.modules`: List of modules to be traced with respective debug level.
- `kamailio.lb.debug_uri.enable`: Enable/disable sending SIP messages From/To specific subscriber to an inactive proxy node in order to debug/trace calls. Only makes sense on Sipwise C5 CARRIER appliance environment.
- `kamailio.lb.debug_uri.redis_db`: A number of internal Redis DB used by `htable` module to keep the subscribers values
- `kamailio.lb.debug_uri.htable_idx_size`: number to control how many slots (buckets) to create for the hash table (  $2^{\text{size}}$  ). See [kamailio htable](#) docs for details.
- `kamailio.lb.debug_level`: Default debug level for `kamailio-lb`.
- `kamailio.lb.dns.use_dns_cache`: Enable/disable use of internal DNS cache.
- `kamailio.lb.dns.dns_udp_pref`: Set preference for each protocol when doing NAPTR lookups. In order to use remote site preferences set all `dns_*_pref` to the same positive value (e.g. `dns_udp_pref=1`, `dns_tcp_pref=1`, `dns_tls_pref=1`, `dns_sctp_pref=1`). To completely ignore NAPTR records for a specific protocol, set the corresponding protocol preference to `-1`.
- `kamailio.lb.dns.dns_tcp_pref`: See above.
- `kamailio.lb.dns.dns_tls_pref`: See above.
- `kamailio.lb.dns.dns_sctp_pref`: See above.
- `kamailio.lb.dns.dns_try_naptr`: Enable NAPTR support according to RFC 3263.
- `kamailio.lb.enable`: Enable/disable `kamailio-lb` service.
- `kamailio.lb.external_sbc`: SIP URI of external SBC used in the Via Route option of peering server.
- `kamailio.lb.extra_sockets`: Add here extra sockets for Load Balancer.
- `kamailio.lb.max_forwards`: Set the value for the Max Forwards SIP header for outgoing messages.
- `kamailio.lb.mem_log`: Specifies on which log level the memory statistics will be logged.
- `kamailio.lb.mem_summary`: Parameter to control printing of memory debugging information on exit or SIGUSR1 to log.
- `kamailio.lb.max_inv_lifetime`: Set INVITE transaction timeout per the whole transaction if no final reply for an INVITE arrives after a provisional message was received (whole transaction ringing timeout). It has to be equals or greater than `kamailio.proxy.tm.fr_inv_timer`.
- `kamailio.lb.nattest_exception_ips`: List of IPs that don't need the NAT test.

- `kamailio.lb.nattest_exception_nets`: List of IP networks (sub-nets) that don't need the NAT test. The format is `network/mask`, see an example of the 'kamailio' section.
- `kamailio.lb.shm_mem`: Shared memory used by Kamailio Load Balancer.
- `kamailio.lb.pkg_mem`: PKG memory used by Kamailio Load Balancer.
- `kamailio.lb.port`: Default listen port.
- `kamailio.lb.remove_isup_body_from_replies`: Enable/disable stripping of ISUP part from the message body.
- `kamailio.lb.sdp_line_filter.enable`: Enable/Disable filter of SDP lines in all the SIP messages.
- `kamailio.lb.sdp_line_filter.remove_line_startswith`: List of the SDP lines that should be removed. Attention: it removes all SDP attribute lines beginning with the listed strings in all media streams.
- `kamailio.lb.security.dos_ban_enable`: Enable/Disable DoS Ban.
- `kamailio.lb.security.dos_ban_time`: Sets the ban time.
- `kamailio.lb.security.dos_reqs_density_per_unit`: Sets the requests density per unit (if we receive more then \* `lb.dos_reqs_density_per_unit` within `dos_sampling_time_unit` the user will be banned).
- `kamailio.lb.security.dos_sampling_time_unit`: Sets the DoS unit time.
- `kamailio.lb.security.dos_whitelisted_ips`: Write here the whitelisted IPs.
- `kamailio.lb.security.dos_whitelisted_subnets`: Write here the whitelisted IP subnets.
- `kamailio.lb.security.failed_auth_attempts`: Sets how many authentication attempts allowed before ban.
- `kamailio.lb.security.failed_auth_ban_enable`: Enable/Disable authentication ban.
- `kamailio.lb.security.failed_auth_ban_time`: Sets how long a user has to be banned.
- `kamailio.lb.security.failed_ip_auth_attempts`: Sets how many authentication attempts allowed before ban the IP.
- `kamailio.lb.security.failed_ip_auth_ban_enable`: Enable/Disable authentication IP ban.
- `kamailio.lb.security.failed_ip_auth_ban_time`: Sets how long a IP has to be banned.
- `kamailio.lb.topoh.enable`: Enable topology masking module (see the [Topology Masking Mechanism](#) subchapter for a detailed description).
- `kamailio.lb.topoh.mask_callid`: if set to **yes**, the SIP Call-ID header will also be encoded.
- `kamailio.lb.topoh.mask_ip`: an IP address that will be used to create valid SIP URIs, after encoding the real/original header content.
- `kamailio.lb.topos.enable`: Enable topology hiding module (see the [Topology Hiding Mechanism](#) subchapter for a detailed description).
- `kamailio.lb.topos.redis_db`: A number of internal Redis DB used by the topology hiding module.
- `kamailio.lb.strict_routing_safe`: Enable strict routing handle feature.
- `kamailio.lb.syslog_options`: Enable/disable logging of SIP OPTIONS messages to **`kamailio-options-lb.log`**.
- `kamailio.lb.tcp_children`: Number of TCP worker processes.
- `kamailio.lb.tcp_max_connections`: Maximum number of open TCP connections.
- `kamailio.lb.tls.enable`: Enable TLS socket.

- `kamailio.lb.tls.port`: Set TLS listening port.
- `kamailio.lb.tls.rand_engine`: Specify the random number generator engine for libssl. We suggest to not touch this option unless you know what you are doing.
- `kamailio.lb.tls.static`: If set to yes, the `kamailio.tlsa` module will be used in substitution of the default `tls` one. It could help in case of crashes related to `openssl`.
- `kamailio.lb.tls.init_mode`: It controls how `kamailio.tls` module is initialized and works at runtime. We suggest to not touch this option unless you know what you are doing.
- `kamailio.lb.tls.connection_timeout`: Sets the amount of time after which an idle TLS connection will be closed, if no I/O ever occurred after the initial open.
- `kamailio.lb.tls.domains`: A list of domains for which the TLS is activated `tls` parameters can be specified.
- `kamailio.lb.tls.domains.<domain>.enable`: Specify if the defined Server or Client TLS domain profiles have to be enabled or not.
- `kamailio.lb.tls.domains.<domain>.type`: Specify of the connection type: server or client. A server TLS domain profile starts with `[server:domain]`. A client TLS domain profile starts with `[client:domain]`.
- `kamailio.lb.tls.domains.<domain>.domain`: Server or Client TLS domain profile name. The 'domain' part can be: 'ip:port' - the IP address and port to match with the TLS connection; 'default' - (static string) for client and server profiles to be used when no other profile is matched; 'any' - (static string) for client and server profiles to be matched based on 'server\_name', regardless TLS connection IP and port. There can be only one of each `[server:default]` and `[client:default]` profile definitions.
- `kamailio.lb.tls.domains.<domain>.description`: Description name of the TLS connection to simplify future debugging.
- `kamailio.lb.tls.domains.<domain>.verify_certificate`: Specify if Kamailio will force certificate verification when connecting to other SIP servers.
- `kamailio.lb.tls.domains.<domain>.require_certificate`: Specify if Kamailio will require a certificate from a client connecting to the TLS port.
- `kamailio.lb.tls.domains.<domain>.tls_method`: Specify the TLS protocol method.
- `kamailio.lb.tls.domains.<domain>.ca_list`: Specify the path of file containing a list of all trusted CAs certs.
- `kamailio.lb.tls.domains.<domain>.cipher_list`: Specify the list of supported SSL ciphers.
- `kamailio.lb.tls.domains.<domain>.sslcertfile`: Specify the SSL certificate to be used for the TLS handshake.
- `kamailio.lb.tls.domains.<domain>.sslcertkeyfile`: Specify the SSL certificate key to be used for the TLS handshake.
- `kamailio.lb.tls.domains.<domain>.server_name`: Sets the SNI (Server Name Indication) used for outbound connections. This is a TLS extension enabling one TLS server to serve multiple host names with unique certificates.
- `kamailio.lb.tls.domains.<domain>.server_name_mode`: Specify how to match the 'server\_name' (SNI). If set to 1, then match the domain and all its subdomains. If set to 2, then match only the subdomains. If set to 0 (or anything else), then match only the domain given in 'server\_name'.
- `kamailio.lb.tls.domains.<domain>.server_id`: The value for 'server\_id' being used to match the TLS client config profile overriding the match on 'ip:port' and 'server\_name'. It is currently not used in the kamailio configuration.

- `kamailio.lb.udp_children`: Number of UDP worker processes.
- `kamailio.proxy.allow_cf_to_itself`: Specify whether or not a Call Forward to the same subscriber (main number to an alias or viceversa) is allowed. To stop the CF loop a source number or a b-number have to be defined in the CF configuration.
- `kamailio.proxy.allow_info_method`: Allow INFO method.
- `kamailio.proxy.allow_msg_method`: Allow MESSAGE method.
- `kamailio.proxy.allow_peer_relay`: Allow peer relay. Call coming from a peer that doesn't match a local subscriber will try to go out again, matching the peering rules.
- `kamailio.proxy.allow_refer_method`: Allow REFER method. Enable it with caution.
- `kamailio.proxy.always_anonymize_from_user`: Enable anonymization of full From URI (as opposed to only From Display-name part by default), has same effect as enabling the preference `anonymize_from_user` for all peers.
- `kamailio.proxy.authenticate_bye`: Enable BYE authentication.
- `kamailio.proxy.cf_depth_limit`: CF loop detector. How many CF loops are allowed before drop the call.
- `kamailio.proxy.cfgt`: Enable/disable unit test config file execution tracing.
- `kamailio.proxy.check_prev_forwarder_as_upn`: Enable/disable validation of the forwarder's number taken from the `Diversion` or `History-Info` header.
- `kamailio.proxy.children`: Number of UDP worker processes.
- `kamailio.proxy.decode_utu_header`: Default 'no'. If set to 'yes', the content of the User-to-User field received in 200Ok is decoded and saved in a dedicated field of the ACC records. The decoding consists in few steps: discard everything after the first occurrence of ';', remove the initial '04', hex decode the remaining part.
- `kamailio.proxy.debug.enable`: Enable per-module debug options.
- `kamailio.proxy.debug.modules`: List of modules to be traced with respective debug level.
- `kamailio.proxy.debug_level`: Default debug level for `kamailio-proxy`.
- `kamailio.proxy.default_expires`: Default expires value in seconds for a new registration (for REGISTER messages that contains neither Expires HFs nor expires contact parameters).
- `kamailio.proxy.default_expires_range`: This parameter specifies that the expiry used for the registration should be randomly chosen in a range given by `default_expires` +/- `default_expires_range` percent. For instance, if `default_expires` is 1200 seconds and `default_expires_range` is 50, the expiry is randomly chosen between [600,1800] seconds. If set to '0', `default_expires` is left unmodified.
- `kamailio.proxy.dlg_timeout`: Dialog timeout in seconds (by default 43200 sec - 12 hours).
- `kamailio.proxy.early_rejects`: Customize here the response codes and sound prompts for various reject scenarios. See the subchapter [Configuring Early Reject Sound Sets](#) for a detailed description.
- `kamailio.proxy.emergency_prioritization.enable`: Enable an emergency mode support.
- `kamailio.proxy.emergency_prioritization.register_fake_200`: When enabled, generates a fake 200 response to REGISTER from non-prioritized subscriber in emergency mode.
- `kamailio.proxy.emergency_prioritization.register_fake_expires`: Expires value for the fake 200 response to REGISTER.
- `kamailio.proxy.emergency_prioritization.reject_code`: Reject code for the non-emergency request.

- `kamailio.proxy.emergency_prioritization.reject_reason`: Reject reason for the non-emergency request.
- `kamailio.proxy.emergency_prioritization.retry_after`: Retry-After value when rejecting the non-emergency request.

**TIP**

In order to learn about details of *emergency prioritization* function of NGCP please refer to [Emergency Prioritization](#) part of the handbook.

- `kamailio.proxy.enable`: Enable/disable kamailio-proxy service.
- `kamailio.proxy.enum_suffix`: Sets ENUM suffix - don't forget '.' (dot).
- `kamailio.proxy.expires_range`: Set randomization of expires for REGISTER messages (similar to `default_expires_range` but applies to received expires value).
- `kamailio.proxy.filter_100rel_from_supported`: Enable filtering of '100rel' from Supported header, to disable PRACK.
- `kamailio.proxy.filter_failover_response`: Specify the list of SIP responses that trigger a failover on the next available peering server.
- `kamailio.proxy.foreign_domain_via_peer`: Enable/disable of routing of calls to foreign SIP URI via peering servers.
- `kamailio.proxy.fritzbox.enable`: Enable detection for Fritzbox special numbers. Ex. Fritzbox add some prefix to emergency numbers.
- `kamailio.proxy.fritzbox.prefixes`: Fritzbox prefixes pattern to check. Ex. 'o\$avp(caller\_ac)'.  
Note: The original text contains a typo 'o\$avp' which has been corrected to 'o\$avp'.
- `kamailio.proxy.fritzbox.special_numbers`: Specifies Fritzbox special number patterns. They will be checked with the prefixes defined. Ex. '112', so the performed check will be 'sip:o\$avp(caller\_ac)112@' if prefix is 'o\$avp(caller\_ac)'.  
Note: The original text contains a typo 'o\$avp' which has been corrected to 'o\$avp'.
- `kamailio.proxy.ignore_auth_realm`: Ignore SIP authentication realm.
- `kamailio.proxy.ignore_subscriber_allowed_clis`: Set to 'yes' to ignore the subscriber's `allowed_clis` preference so that the User-Provided CLI is only checked against customer's `allowed_clis` preference.
- `kamailio.proxy.lcr_stopper_mode`: 0, default mode first rule to match will stop the gw matching process. 1, lcr will keep matching gws even if the rule has stopper value and after ordering gws by priority it will obey the first stopper value and discard the rest.
- `kamailio.proxy.latency_limit_action`: Limit of runtime in ms for config actions. If a config action executed by cfg interpreter takes longer than this value, a message is printed in the logs.
- `kamailio.proxy.latency_limit_db`: Limit of runtime in ms for DB queries. If a DB operation takes longer than this value, a warning is printed in the logs.
- `kamailio.proxy.latency_log_level`: Log level to print the messages related to latency. Default is 1 (INFO).
- `kamailio.proxy.latency_runtime_action`: Limit of runtime in ms for SIP message processing cycle. If the SIP message processing takes longer than this value, a warning is printed in the logs.
- `kamailio.proxy.keep_original_to`: Not used now.
- `kamailio.proxy.lnp.add_reply_headers.enable`: Enable/disable dedicated headers to be added after LNP lookup.
- `kamailio.proxy.lnp.add_reply_headers.number`: Name of the header that will contain the LNP number.

- `kamailio.proxy.lnp.add_reply_headers.status`: Name of the header that will contain the LNP return code (200 if OK, 500/480/... if an error/timeout is occurred).
- `kamailio.proxy.lnp.api.add_caller_cc_to_lnp_dst`: Enable/disable adding of caller country code to LNP routing number of the result ('no' by default, LNP result in E.164 format is assumed).
- `kamailio.proxy.lnp.api.invalid_lnp_routing_codes` (only for **api** type): number matching pattern for routing numbers that represent invalid call destinations; an announcement is played in that case and the call is dropped.
- `kamailio.proxy.lnp.api.keepalive_interval`: Not used now.
- `kamailio.proxy.lnp.api.lnp_request_whitelist` (only for **api** type): list of matching patterns of called numbers for which LNP lookup must be done.
- `kamailio.proxy.lnp.api.lnp_request_blacklist` (only for **api** type): list of matching patterns of called numbers for which LNP lookup must not be done.
- `kamailio.proxy.lnp.api.port`: Not used now.
- `kamailio.proxy.lnp.api.reply_error_on_lnp_failure`: Specifies whether platform should drop the call in case of LNP API server failure or continue routing the call to the original callee without LNP.
- `kamailio.proxy.lnp.api.request_timeout` (only for **api** type): timeout in milliseconds while Proxy waits for the response of an LNP query from *Sipwise LNP daemon*.
- `kamailio.proxy.lnp.api.server`: Not used now.
- `kamailio.proxy.lnp.api.tcap_field_fci`: path of the FCI INFO in the received tcap message
- `kamailio.proxy.lnp.api.tcap_field_lnp`: path of the LNP NUMBER in the received tcap/inap message
- `kamailio.proxy.lnp.api.tcap_field_opcode`: path of the FCI OPCODE in the received tcap message
- `kamailio.proxy.lnp.enable`: Enable/disable LNP (local number portability) lookup during call setup.
- `kamailio.proxy.lnp.execute_ncos_block_out_before_lnp`: if set to 'yes', the NCOS and BLOCK\_OUT checks will be executed before the LNP lookup. Default is 'no', therefore the check are done after the LNP evaluation and rewriting.
- `kamailio.proxy.lnp.skip_callee_lnp_lookup_from_any_peer`: if set to 'yes', the destination LNP lookup is skipped (has same effect as enabling preference `skip_callee_lnp_lookup_from_any_peer` for all peers).
- `kamailio.proxy.lnp.strictly_check_ncos`: specify whether the NCOS LNP should be evaluated even if the LNP lookup was not previously executed or if it didn't return any occurrence. If set to *yes*, a whitelist NCOS will fail if the LNP lookup doesn't return any match. The parameter has no impact on blacklist NCOS.
- `kamailio.proxy.lnp.type`: method of LNP lookup; valid values are: **local** (local LNP database) and **api** (LNP lookup through external gateways). *PLEASE NOTE*: the **api** type of LNP lookup is only available for Sipwise C5 PRO / CARRIER installations.
- `kamailio.proxy.lookup_peer_destination_domain_for_pbx`: one of [yes, no, peer\_host\_name] - Sets the content of destination\_domain CDR field for calls between CloudPBX subscribers. In case of 'no' this field contains name of CloudPBX domain; 'yes': peer destination domain; 'peer\_host\_name': human-readable name of the peering server.
- `kamailio.proxy.loop_detection.enable`: Enable the SIP loop detection based on the combination of SIP-URI, To and From header URIs.
- `kamailio.proxy.loop_detection.expire`: Sampling interval in seconds for the incoming INVITE requests (by default 1 sec).

- `kamailio.proxy.loop_detection.max`: Maximum allowed number of SIP requests with the same SIP-URI, To and From header URIs within sampling interval. Requests in excess of this limit will be rejected with 482 Loop Detected response.
- `kamailio.proxy.max_expires`: Sets the maximum expires in seconds for registration. If set to '0', the check is disabled.
- `kamailio.proxy.max_gw_lcr`: Defines the maximum number of gateways in `lcr_gw` table
- `kamailio.proxy.max_registrations_per_subscriber`: Sets the maximum registration per subscribers.
- `kamailio.proxy.mem_log`: Specifies on which log level the memory statistics will be logged.
- `kamailio.proxy.mem_summary`: Parameter to control printing of memory debugging information on exit or SIGUSR1 to log.
- `kamailio.proxy.min_expires`: Sets the minimum expires in seconds for registration. If set to '0', the check is disabled.
- `kamailio.proxy.nathelper.sipping_from`: Set the From header in OPTIONS NAT ping.
- `kamailio.proxy.nathelper_dbro`: Default is "no". This will be "yes" on CARRIER in order to activate the use of a read-only connection using LOCAL\_URL
- `kamailio.proxy.natping_interval`: Sets the NAT ping interval in seconds.
- `kamailio.proxy.natping_processes`: Set the number of NAT ping worker processes.
- `kamailio.proxy.nonce_expire`: Nonce expire time in seconds.
- `kamailio.proxy.pbx.hunt_display_fallback_format`: Default is '[H %s]'. Sets the format of the hunt group indicator that is sent as initial part of the From Display Name when subscriber is called as a member of PBX hunt group if the preferred format defined by the `hunt_display_format` and `hunt_display_indicator` can not be used (as in the case of not provisioned subscriber settings). The '%s' part is replaced with the value of the `hunt_display_fallback_indicator` variable.
- `kamailio.proxy.pbx.hunt_display_fallback_indicator`: The internal kamailio variable that sets the number or extension of the hunt group. Default is `$var(cloud_pbx_hg_ext)` which is populated during call routing with the extension of the hunt group.
- `kamailio.proxy.pbx.hunt_display_format`: Default is '[H %s]'. Sets the format of hunt group indicator that is sent as initial part of the From Display Name when subscriber is called as a member of PBX hunt group. This is the preferred (default) indicator format with Display Name, where the '%s' part is replaced with the value of the `hunt_display_indicator` variable.
- `kamailio.proxy.pbx.hunt_display_indicator`: The internal kamailio variable that contains the preferred identifier of the hunt group. Default is `$var(cloud_pbx_hg_displayname)` which is populated during call routing with the provisioned Display Name of the hunt group.
- `kamailio.proxy.pbx.hunt_display_maxlength`: Default is '8'. Sets the maximum length of the variable used as the part of hunt group indicator in Display Name. The characters beyond this limit are truncated in order for hunt group indicator and calling party information to fit on display of most phones.
- `kamailio.proxy.pbx.ignore_cf_when_hunting`: Default is 'no'. Whether to disregard all individual call forwards (CFU, CFB, CFT and CFNA) of PBX extensions when they are called via hunt groups. Note that call forwards configured to local services such as Voicebox or Conference are always skipped from group hunting.
- `kamailio.proxy.peer_probe.enable`: Enable the peer probing, must be also checked per individual peer in the panel/API.

- `kamailio.proxy.peer_probe.interval`: Peer probe interval in seconds.
- `kamailio.proxy.peer_probe.timeout`: Peer probe response wait timeout in seconds.
- `kamailio.proxy.peer_probe.reply_codes`: Defines the response codes that are considered successful response to the configured probe request, e.g. `class=2;class=3;code=403;code=404;code=405`, with class defining a code range.
- `kamailio.proxy.peer_probe.unavailable_treshold`: Defines after how many failed probes a peer is considered unavailable.
- `kamailio.proxy.peer_probe.available_treshold`: Defines after how many successful probes a peer is considered available.
- `kamailio.proxy.peer_probe.from_uri_user`: From-userpart for the probe requests.
- `kamailio.proxy.peer_probe.from_uri_domain`: From-hostpart for the probe requests.
- `kamailio.proxy.peer_probe.method`: [OPTIONS|INFO] - Request method for probe request.

**TIP**

You can find more information about peer probing configuration in [Configuration of Peer Probing](#) of the handbook.

- `kamailio.proxy.perform_peer_failover_on_tm_timeout`: Specifies the failover behavior when maximum ring timeout (`fr_inv_timer`) has been reached. In case it is set to 'yes': failover to the next peer if any; in case of 'no' stop trying other peers.
- `kamailio.proxy.perform_peer_lcr`: Enable/Disable Least Cost Routing based on peering fees.
- `kamailio.proxy.pkg_mem`: PKG memory used by Kamailio Proxy.
- `kamailio.proxy.shm_mem`: Shared memory used by Kamailio Proxy.
- `kamailio.proxy.port`: SIP listening port.
- `kamailio.proxy.presence.enable`: Enable/disable presence feature
- `kamailio.proxy.presence.max_expires`: Sets the maximum expires value for PUBLISH/SUBSCRIBE message. Defines expiration of the presentity record.
- `kamailio.proxy.presence.reginfo_domain`: Set FQDN of Sipwise C5 domain used in callback for mobile push.
- `kamailio.proxy.push.apns_alert`: Set the content of 'alert' field towards APNS.
- `kamailio.proxy.push.apns_sound`: Set the content of 'sound' field towards APNS.
- `kamailio.proxy.push.code_18x`: code to be sent if `reply_18x` is 'yes'. Default: 180.
- `kamailio.proxy.push.reason_18x`: reason phrase to be sent if `reply_18x` is 'yes'. Default: 'Ringing'.
- `kamailio.proxy.push.reply_18x`: If set to 'yes' proxy will send a 18x message using `code_18x` and `reason_18x` config values after sending the PUSH notification. So caller will hear a fake ringing while the app is waking.
- `kamailio.proxy.report_mos`: Enable MOS reporting in the log file.
- `kamailio.proxy.set_ruri_to_peer_auth_realm`: Set R-URI using peer auth realm.
- `kamailio.proxy.stir.cache_dir`: A path to the directory where to store cached public keys. This directory must be r/w for kamailio user.
- `kamailio.proxy.stir.cache_expire`: An interval in seconds after which a cached public key is considered expired.

- `kamailio.proxy.stir.domains`: A list of domains for which STIR is enabled, includes the 'name' - domain name (FQDN), the 'private\_key' - a path to the private key.
- `kamailio.proxy.stir.enable`: Enable or disable STIR/SHAKEN support in Sipwise C5.
- `kamailio.proxy.stir.libopt`: Optional, set a libsecsipid option. The value has to be a list of options: *name=value*.
- `kamailio.proxy.stir.shaken`: A sub-block of options related to a treatment of incoming calls (mostly is used to define what are the values to be used in PAI header). For now Sipwise C5 only controls with it an optional parameter 'verstat' for the PAI header.
- `kamailio.proxy.stir.timeout`: An interval in seconds after which the HTTP GET operation to download the public key times out.
- `kamailio.proxy.skip_pbx_loop`: Enable or disable the sems pbx loop for pbx subscribers
- `kamailio.proxy.store_recentcalls`: Store recent calls to redis (used by Malicious Call Identification application and VSCs related to recent calls redial).
- `kamailio.proxy.syslog_options`: Enable/disable logging of SIP OPTIONS messages to `kamailio-options-proxy.log`.
- `kamailio.proxy.tcp_children`: Number of TCP worker processes.
- `kamailio.proxy.tm.fr_inv_timer`: Set INVITE transaction timeout per branch if no final reply for an INVITE arrives after a provisional message was received (branch ringing timeout).
- `kamailio.proxy.tm.fr_timer`: Set INVITE transaction timeout if the destination is not responding with provisional response message.
- `kamailio.proxy.tm.max_inv_lifetime`: Set INVITE transaction timeout per the whole transaction if no final reply for an INVITE arrives after a provisional message was received (whole transaction ringing timeout). It has to be equals or greater than `kamailio.proxy.tm.fr_inv_timer`.
- `kamailio.proxy.treat_600_as_busy`: Enable the 6xx response handling according to RFC3261. When enabled, the 6xx response should stop the serial forking. Also, CFB will be triggered or busy prompt played as in case of 486 Busy response.
- `kamailio.proxy.use_enum`: Enable/Disable ENUM feature.
- `kamailio.proxy.usrloc_dbmode`: Set the mode of database usage for persistent contact storage.
- `kamailio.proxy.voicebox_first_caller_cli`: When enabled the previous forwarder's CLI will be used as caller CLI in case of chained Call Forwards.
- `kamailio.proxy.xfer_other_party_from`: If set to 'yes' transferred calls will have the number of the transferred party in the From header. Default is 'no', thus transferred calls have the number of the transferrer party in the From header.

## ngcp-lnpd

The following section defines configuration of LNP daemon, that is used when LNP queries are served by external gateways the so called LNP API mode.

```
lnpd:
  config:
    daemon:
      foreground: 'false'
    json_rpc:
```

```

ports:
  - '8095'
loglevel: '6'
sip:
  port: '5095'
  threads: '4'
instances:
  default:
    module: sigtran
    destination: 0.0.0.0
    from-domain: voip.example.com
    headers:
      - header: INAP-Service-Key
        value: '2'
    reply:
      tcap: raw-tcap
enable: no

```

- `lnpd.enable`: Enable/disable LNP daemon
- `lnpd.config`: details are shown in [Configuration of LNP daemon](#)

### ngcp-logfs

The following section configures the log obfuscation service.

```

logfs:
  cache_db: /usr/lib/ngcp-logfs/cache.db
  chmod_dirs: '0555'
  chmod_files: '0444'
  disk_retention_timeout: 365
  enable: yes
  file_cache_timeout: 2
  gid: 0
  log_dir: /var/log/ngcp
  max_mem_usage: 500
  mem_cache_timeout: 24
  mountpoint: /var/log/mirror-ngcp
  suffix: \.d+$|-d{8}$|-d{8}-d+$
  uid: 0

```

- `logfs`: details are shown in the section on [Log file obfuscation](#)

### ngcp-mediator

The following is the `ngcp-mediator` section:

```

mediator:
  interval: 10

```

- mediator.interval: Running interval of *ngcp-mediator*.

## modules

The following is the modules section:

```
modules:  
  - enable: no  
    name: dummy  
    options: numdummies=2
```

- modules: list of configs needed for load kernel modules on boot.
- enable: Enable/disable loading of the specific module (yes/no)
- name: kernel module name
- options: kernel module options if needed

## monitoring

The following is the monitoring section:

```
monitoring:  
  backend: prometheus  
  filesystems:  
  - /  
  - /ngcp-data  
  - /ngcp-fallback  
  - /mnt/glusterfs  
  interval: 10  
  prometheus_server: victoria-metrics  
  retention_policy_long_duration: 12  
  retention_policy_short_duration: 15  
  retrospect_interval: 30  
  threshold:  
    cpu_idle_min: '0.1'  
    disk_used_max: '0.9'  
    kamilio_lb_pkgmem_min: 1048576  
    kamilio_lb_shmem_min: '1048576'  
    kamilio_proxy_pkgmem_min: 1048576  
    kamilio_proxy_shmem_min: '1048576'  
    load_long_max: 0.75  
    load_medium_max: 0.75  
    load_short_max: 1.0  
    mem_used_max: 0.98  
    mta_queue_len_max: '15'  
    mysql_replication_delay_max: 60  
    sip_responsiveness_max: '15'  
    sslcert_timetoexpiry: '30'  
    sslcert_whitelist: []  
    swap_free_min: 0.02
```

```
timeout: 10
```

- `monitoring.backend`: The monitoring implementation backend to use. Valid value is: 'prometheus' (default).
- `monitoring.filesystems`: The filesystem mount points to monitor.
- `monitoring.interval`: The number of seconds between each data gathering iteration.
- `monitoring.prometheus_server`: The prometheus server implementation to use. Either 'victoria-metrics' (default) or 'prometheus'.
- `monitoring.retention_policy_long_duration`: The long term retention policy for metrics in the monitoring database in months.
- `monitoring.retention_policy_short_duration`: The short term retention policy for metrics in the monitoring database in days.
- `monitoring.restrospect_interval`: The number of seconds to look into the past, when checking for the last value for a data point.
- `monitoring.threshold.*`: These settings specify the thresholds that once crossed will make various components on the system (that is *ngcp-status*, *ngcp-collective-check*, *snmpd* or *monit*) emit alarms or warnings.
- `monitoring.threshold.cpu_idle_min`: Sets the minimum value for CPU usage (0.1 means 10%).
- `monitoring.threshold.disk_used_max`: Sets the maximum value for DISK usage (0.9 means 90%).
- `monitoring.threshold.kamailio_lb_pkgmem_min`: Sets the minimum value for Kamailio lb package memory usage per process.
- `monitoring.threshold.kamailio_lb_shmem_min`: Sets the minimum value for Kamailio lb shared memory usage.
- `monitoring.threshold.kamailio_proxy_pkgmem_min`: Sets the minimum value for Kamailio proxy package memory usage per process.
- `monitoring.threshold.kamailio_proxy_shmem_min`: Sets the minimum value for Kamailio proxy shared memory usage.
- `monitoring.threshold.load_long_max/load_long_max/load_short_max`: Base values for load (long, short, medium term) that will get scaled over the node CPU count to obtain the max values (base \* cpu).
- `monitoring.threshold.mem_used_max`: Sets the maximum value for memory usage (0.7 means 70%).
- `monitoring.threshold.mta_queue_len_max`: Sets the maximum value for the MTA queue length.
- `monitoring.threshold.mysql_replication_delay_max`: Sets the maximum MySQL replication delay in seconds.
- `monitoring.threshold.sip_responsiveness_max`: Sets the maximum SIP responsiveness time timeout for the SIP options.
- `monitoring.threshold.sslcert_timetoexpiry`: Sets the number of days before a SSL certificate expiry starts to warn.
- `monitoring.threshold.sslcert_whitelist`: Sets a list of SSL certificate fingerprints to whitelist from the expiry check.
- `monitoring.threshold.swap_free_min`: Sets the minimum value for free swap (0.5 means 50%).

- `monitoring.timeout`: The timeout for backend queries in seconds, after which the query is considered to have failed due to lack of responsiveness.

## nginx

The following is the nginx section:

```
nginx:
  status_port: 8081
  xcap_port: 1080
```

- `nginx.status_port`: Status port used by nginx server
- `nginx.xcap_port`: XCAP port used by nginx server

## ntp

The following is the ntp server section:

```
ntp:
  servers:
    - 0.debian.pool.ntp.org
    - 1.debian.pool.ntp.org
    - 2.debian.pool.ntp.org
    - 3.debian.pool.ntp.org
```

- `ntp.servers`: Define your NTP server list.

## ossbss

The following is the ossbss section:

```
ossbss:
  apache:
    port: 2443
    proxyport: 1080
  restapi:
    sslcertfile: '/etc/ngcp-panel/api_ssl/api_ca.crt'
    sslcertkeyfile: '/etc/ngcp-panel/api_ssl/api_ca.key'
  serveradmin: support@sipwise.com
  servername: "\"myserver\""
  ssl_enable: yes
  sslcertfile: '/etc/ngcp-config/shared-files/ssl/myserver.crt'
  sslcertkeyfile: '/etc/ngcp-config/shared-files/ssl/myserver.key'
  frontend: no
  htpasswd:
    -
      pass: '{SHA}w4zj3mxbmynIQ1jsUEjSkN2z2pk='
      user: ngcpsoup
  logging:
```

```

apache:
  acc:
    facility: daemon
    identity: oss
    level: info
  err:
    facility: local7
    level: info
  ossbss:
    facility: local0
    identity: provisioning
    level: DEBUG
  web:
    facility: local0
    level: DEBUG
provisioning:
  allow_ip_as_domain: 1
  allow_numeric_usernames: 0
  auto_allow_cli: 1
  carrier:
    account_distribution_function: roundrobin
    prov_distribution_function: roundrobin
  credit_warnings:
    -
      domain: example.com
      recipients:
        - nobody@example.com
      threshold: 1000
  faxpw_min_char: 0
  log_passwords: 0
  no_logline_truncate: 0
  pw_min_char: 6
  routing:
    ac_regex: '[1-9]\d{0,4}'
    cc_regex: '[1-9]\d{0,3}'
    sn_regex: '[1-9]\d+'
  tmpdir: '/tmp'

```

- `ossbss.frontend`: Enable/disable SOAP interface. Set value to 'fcgi' to enable old SOAP interface.
- `ossbss.htpasswd`: Sets the username and SHA hashed password for SOAP access. You can generate the password using the following command: `htpasswd -nbs myuser mypassword`.
- `ossbss.provisioning.allow_ip_as_domain`: Allow or not allow IP address as SIP domain (0 is not allowed).
- `ossbss.provisioning.allow_numeric_usernames`: Allow or not allow numeric SIP username (0 is not allowed).
- `ossbss.provisioning.faxpw_min_char`: Minimum number of characters for fax passwords.
- `ossbss.provisioning.pw_min_char`: Minimum number of characters for sip passwords.
- `ossbss.provisioning.log_password`: Enable logging of passwords.

- ossbss.provisioning.routing: Regexp for allowed AC (Area Code), CC (Country Code) and SN (Subscriber Number).

### pbx (only with additional Cloud PBX module activated)

The following is the PBX section:

```
pbx:
  enable: no
```

- pbx.enable: Enable Cloud PBX module.

### pushd

The following is the pushd section:

```
pushd:
  apns:
    enable: yes
    endpoint: api.push.apple.com
    endpoint_port: 0
    extra_instances:
      - certificate: '/etc/ngcp-config/shared-
files/ssl/PushCallkitCert.pem'
        enable: yes
        key: '/etc/ngcp-config/shared-files/ssl/PushCallkitKey.pem'
        type: callkit
    http2_jwt:
      ec_key: '/etc/ngcp-config/shared-files/ssl/AuthKey_ABCDE12345.pem'
      ec_key_id: 'ABCDE12345'
      enable: yes
      issuer: 'VWXYZ67890'
      tls_certificate: ''
      tls_key: ''
      topic: 'com.example.appID'
    legacy:
      certificate: '/etc/ngcp-config/shared-files/ssl/PushChatCert.pem'
      feedback_endpoint: feedback.push.apple.com
      feedback_interval: '3600'
      key: '/etc/ngcp-config/shared-files/ssl/PushChatKey.pem'
      socket_timeout: 0
  domains:
    - apns:
      endpoint: api.push.apple.com
      extra_instances:
        - certificate: '/etc/ngcp-config/shared-files/ssl/PushCallkitCert-
example.com.pem'
          enable: no
          key: '/etc/ngcp-config/shared-files/ssl/PushCallkitKey-
example.com.pem'
```

```

    type: callkit
    http2_jwt:
      ec_key: '/etc/ngcp-config/shared-
files/ssl/AuthKey_54321EDCBA.pem'
      ec_key_id: '54321EDCBA'
      issuer: '09876ZYXWV'
      tls_certificate: ''
      tls_key: ''
      topic: 'com.example.otherAppID'
    legacy:
      certificate: '/etc/ngcp-config/shared-files/ssl/PushChatCert-
example.com.pem'
      feedback_endpoint: feedback.push.apple.com
      key: '/etc/ngcp-config/shared-files/ssl/PushChatKey-
example.com.pem'
      domain: example.com
      enable: yes
      android:
        key: 'google_api_key_for_example.com_here'
      enable: yes
      android:
        enable: yes
        key: 'google_api_key_here'
      priority:
        call: high
        groupchat: normal
        invite: normal
        message: normal
      muc:
        exclude: []
        force_persistent: 'true'
        owner_on_join: 'true'
      one_device_per_subscriber: no
      port: 45060
      processes: 4
      ssl: yes
      sslcertfile: /etc/ngcp-config/shared-files/ssl/CAsigned.crt
      sslcertkeyfile: /etc/ngcp-config/shared-files/ssl/CAsigned.key
      unique_device_ids: no

```

- pushd.enable: Enable/Disable the Push Notification feature.
- pushd.apns.enable: Enable/Disable Apple push notification.
- pushd.apns.endpoint: API endpoint hostname or address. Should be one of 'api.push.apple.com' or 'api.development.push.apple.com' for the newer HTTP2/JWT based protocol, or one of 'gateway.push.apple.com' or 'gateway.sandbox.push.apple.com' for the legacy protocol.
- pushd.apns.endpoint\_port: API endpoint port. Normally 443 or alternatively 2197 for the newer HTTP2/JWT based protocol, or 2195 for the legacy protocol.
- pushd.apns.legacy: Contains all options specific to the legacy APNS protocol. Ignored when HTTP2/JWT is in use.

- `pushd.apns.legacy.certificate`: Specify the Apple certificate for push notification https requests from Sipwise C5 to an endpoint.
- `pushd.apns.legacy.key`: Specify the Apple key for push notification https requests from Sipwise C5 to an endpoint.
- `pushd.apns.legacy.feedback_endpoint`: Hostname or address of the APNS feedback service. Normally one of 'feedback.push.apple.com' or 'feedback.sandbox.push.apple.com'.
- `pushd.apns.legacy.feedback_interval`: How often to poll the feedback service, in seconds.
- `pushd.apns.extra_instances`: If the iOS app supports Callkit push notifications, they can be enabled here and the required separate certificate and key can be specified. Ignored if HTTP2/JWT is enabled.
- `pushd.http2_jwt`: Contains all options specific to the newer HTTP2/JWT based APNS API protocol.
- `pushd.http2_jwt.ec_key`: Name of file that contains the elliptic-curve (EC) cryptographic key provided by Apple, in PEM format.
- `pushd.http2_jwt.ec_key_id`: 10-digit identification string of the EC key in use.
- `pushd.http2_jwt.enable`: Master switch for the HTTP2/JWT based protocol. Disables the legacy protocol when enabled.
- `pushd.http2_jwt.issuer`: Issuer string for the JWT token. Normally the 10-digit team ID string for which the EC key was issued.
- `pushd.http2_jwt.tls_certificate`: Optional client certificate to use for the TLS connection.
- `pushd.http2_jwt.tls_key`: Optional private key for the client certificate to use for the TLS connection.
- `pushd.http2_jwt.topic`: Topic string for the JWT token. Normally the bundle ID for the iOS app.
- `pushd.android.enable`: Enable/Disable Google push notification.
- `pushd.android.key`: Specify the Google key for push notification https requests from Sipwise C5 to an endpoint.
- `pushd.domains`: Supports a separate set of push configurations (API keys, certificates, etc) for all subscribers of the given domain.
- `pushd.muc.exclude`: list of MUC room jids excluded from sending push notifications.
- `pushd.muc.force_persistent`: Enable/Disable MUC rooms to be persistent. Needed for Sipwise C5 app to work with other clients.
- `pushd.muc.owner_on_join`: Enable/Disable all MUC participants to be owners of the MUC room. Needed for Sipwise C5 app to work with other clients.
- `pushd.ssl`: The security protocol Sipwise C5 uses for https requests from the app in the push notification process.
- `pushd.sslcertfile`: The trusted certificate file purchased from a CA
- `pushd.sslcertkeyfile`: The key file that purchased from a CA
- `pushd.unique_device_ids`: Allows a subscriber to register the app and have the push notification enabled on more than one mobile device.

## qos

The QoS section allows configuring the ToS (Type of Service) feature:

```
qos:
  tos_rtp: 184
  tos_sip: 184
```

- qos.tos\_rtp: a ToS value for RTP traffic.
- qos.tos\_sip: a ToS value for SIP traffic.

**TIP**

The ToS byte includes both DSCP and ECN bits. So, specify the DSCP value multiplied by four (46x4=184) and, optionally, add the required ECN value to it (1, 2 or 3).

Set the `rtengine.control_tos` parameter higher than zero to enable ToS.

**ngcp-rate-o-mat**

The following is the *ngcp-rate-o-mat* section:

```
rateomat:
  enable: yes
  loopinterval: 10
  splitpeakparts: 0
```

- rateomat.enable: Enable/Disable *ngcp-rate-o-mat*
- rateomat.loopinterval: How long we shall sleep before looking for unrated CDRs again.
- rateomat.splitpeakparts: Whether we should split CDRs on peaktime borders.

**ngcp-task-agent**

The following is the *ngcp-task-agent* section:

```
ngcp-task-agent:
  enable: yes
```

- ngcp-task-agent.enable: Enable/Disable *ngcp-task-agent*.

**reminder**

The following is the *reminder* section:

```
reminder:
  retries: 2
  retry_time: 60
  sip_fromdomain: voicebox.sipwise.local
  sip_fromuser: reminder
  wait_time: 30
  weekdays: '2, 3, 4, 5, 6, 7'
```

- `reminder.retries`: How many times the reminder feature have to try to call you.
- `reminder.retry_time`: Seconds between retries.
- `reminder.wait_time`: Seconds to wait for an answer.

## rsyslog

The following is the rsyslog section:

```
rsyslog:
  external_logging:
    - address: 192.168.32.1
      enable: no
      loglevel: warning
      port: '514'
      proto: udp
  ngcp_logs_max_size: 2G
  ngcp_logs_preserve_days: '93'
```

- `rsyslog.external_logging`: List of remote syslog servers.
- `rsyslog.external_logging.address`: Address of this remote syslog server.
- `rsyslog.external_logging.enable`: Enable or disable this remote syslog destination.
- `rsyslog.external_logging.loglevel`: Minimum log level to send to this syslog destination.
- `rsyslog.external_logging.port`: Port of this remote syslog server.
- `rsyslog.external_logging.proto`: Protocol (udp or tcp) for this remote syslog server.
- `rsyslog.ngcp_logs_max_size`: Specify a maximum size for log files before they are rotated away.
- `rsyslog.ngcp_logs_preserve_days`: Specify how many days to preserve old rotated log files in `/var/log/ngcp/old` path.

## rtpengine

The following is the rtp proxy section:

```
rtpengine:
  allow_userspace_only: yes
  cdr_logging_facility: ''
  control_tos: 0
  delete_delay: 30
  dtls_passive: no
  enable: yes
  final_timeout: 0
  firewall_iptables_chain: ''
  graphite:
    interval: 600
    prefix: rtpengine.
    server: ''
  log_level: '6'
```

```

maxport: '40000'
minport: '30000'
num_threads: 0
prefer_bind_on_internal: no
recording:
  add_header_for_external_callrecording: ''
  egress: no
  enable: no
  lightweight_lawful_intercept:
    enable: no
    recording_pattern: lwli-%{uuid}-%{callee}-%Y%m%d%H%M%S
  log_level: 6
  mix_method: direct
  mp3_bitrate: '48000'
  nfs_host: 192.168.1.1
  nfs_remote_path: /var/recordings
  output_chgrp: _ngcp-admin
  output_chmod: '0660'
  output_chmod_dir: '0770'
  output_chown: root
  output_dir: /var/lib/rtpengine-recording
  output_format: wav
  output_mixed: yes
  output_pattern: '%c-%r-%t'
  output_single: yes
  resample: no
  resample_to: '16000'
  spool_dir: /var/spool/rtpengine
  storage_db: no
  storage_file: yes
  storage_local: no
  vsc:
    pause_recording: '555'
    pause_resume_recording: '666'
    start_pause_resume_recording: '777'
    start_recording: '888'
    start_stop_recording: '999'
    stop_recording: '000'
  rtcp_logging_facility: ''
  rtp_timeout: '60'
  rtp_timeout_onhold: '3600'

```

- `rtpengine.allow_userspace_only`: Enable/Disable the user space failover for rtpengine ('yes' means enable). By default rtpengine works in kernel space.
- `rtpengine.cdr_logging_facility`: If set, rtpengine will produce a CDR-like syslog line after each call finishes. Must be set to a valid syslog facility string (such as 'daemon' or 'local0').
- `rtpengine.control_tos`: If higher than 0, the control messages port uses the configured ToS (Type of Service) bits. See the QoS section below for details.
- `rtpengine.delete_delay`: After a call finishes, rtpengine will wait this many seconds before cleaning up resources. Useful for possible late branched calls.

- `rtengine.dtls_passive`: If enabled, `rtengine` will always advertise itself as a passive role in DTLS setup. Useful in WebRTC scenarios if used behind NAT.
- `rtengine.final_timeout`: If set, any calls lasting longer than this many seconds will be terminated, no matter the circumstances.
- `rtengine.firewall_iptables_chain`: If set, `rtengine` will create an iptables rule for each individual media port opened in this chain.
- `rtengine.graphite.interval`: Interval in seconds between sending updates to the Graphite server.
- `rtengine.graphite.prefix`: Graphite keys will be prefixed with this string. Must include a separator character (such as a trailing dot) if one should be used.
- `rtengine.graphite.server`: Graphite server to send periodic statistics updates to. Disabled if set to an empty string. Must be in format 'IP:port' or 'hostname:port'.
- `rtengine.log_level`: Verbosity of log messages. The default '6' logs everything except debug messages. Increase to 7 to log everything, or decrease to make logging more quiet.
- `rtengine.maxport`: Maximum port used by `rtengine` for RTP traffic.
- `rtengine.minport`: Minimum port used by `rtengine` for RTP traffic.
- `rtengine.num_threads`: Number of worker threads to use. If set to 0, the number of CPU cores will be used.
- `rtengine.recording.add_header_for_external_callrecording`: Specify the header to add for external Call Recording.
- `rtengine.recording.egress`: Record egress (transmitted) audio streams instead of ingress (received).
- `rtengine.recording.enable`: Enable support for call recording.
- `rtengine.recording.mp3_bitrate`: If saving audio as MP3, bitrate of the output file.
- `rtengine.recording.log_level`: Same as `log_level` above, but for the recording daemon.
- `rtengine.recording.nfs_host`: Mount an NFS share from this host for storage.
- `rtengine.recording.nfs_remote_path`: Remote path of the NFS share to mount.
- `rtengine.recording.output_chgrp`: Change the file ownership to the given group name or group ID.
- `rtengine.recording.output_chmod`: Change the mode of created files (in octal). Default is octal 0660. Can be set to 0 to disable and leave the mode to the umask.
- `rtengine.recording.output_chmod_dir`: Change the mode of created directories (in octal). Default is octal 0770. Can be set to 0 to disable and leave the mode to the umask.
- `rtengine.recording.output_chown`: Change the file ownership to the given user name or user ID.
- `rtengine.recording.output_dir`: Local mount point for the NFS share.
- `rtengine.recording.output_format`: Either 'wav' for PCM output or 'mp3'.
- `rtengine.recording.output_mixed`: Create output audio files with all contributing audio streams mixed together.
- `rtengine.recording.mix_method`: Mix all audio inputs together directly, or output them as individual channels.
- `rtengine.recording.output_single`: Create separate audio files for each contributing audio stream.
- `rtengine.recording.output_pattern`: File name pattern for created recording files. Defaults to '%c-%t' to include call ID and recording type.

- `rtengine.recording.resample`: Resample all audio to a fixed bitrate ('yes' or 'no').
- `rtengine.recording.resample_to`: If resampling is enabled, resample to this sample rate.
- `rtengine.recording.spool_dir`: Local directory for temporary metadata file storage.
- `rtengine.recording.storage_file`: Enable or disable storing of recordings as files.
- `rtengine.recording.storage_db`: Enable or disable storing of recordings in database storage. EXPERIMENTAL MODE OF OPERATION.
- `rtengine.recording.storage_local`: Enable or disable storing of recordings as local (non-NFS) files. UNSUPPORTED MODE OF OPERATION.
- `rtengine.recording.lightweight_lawful_intercept.enable`: Enable or disable the Lightweight Lawful Interception. This will disable the standard call recording feature for end users.
- `rtengine.recording.lightweight_lawful_intercept.recording_pattern`: File name pattern for created Lightweight Lawful Interception recording files. Defaults to 'lwli-#{uuid}-#{callee}-%Y%m%d%H%M%S' to include caller, callee, date and time.
- `rtengine.recording.vsc.start_recording`: DTMF VSC to start recording if not already started or resume if paused.
- `rtengine.recording.vsc.stop_recording`: DTMF VSC to stop recording if currently active or paused.
- `rtengine.recording.vsc.pause_recording`: DTMF VSC to pause recording if currently active.
- `rtengine.recording.vsc.start_stop_recording`: DTMF VSC to start recording if currently active or stop if running or paused.
- `rtengine.recording.vsc.pause_resume_recording`: DTMF VSC to pause recording if currently active or resume if paused.
- `rtengine.recording.vsc.start_pause_resume_recording`: DTMF VSC to start recording if not already started, pause if running, or resume if paused.
- `rtengine.rtcp_logging_facility`: If set, `rtengine` will write the contents of all received RTCP packets to syslog. Must be set to a valid syslog facility string (such as 'daemon' or 'local0').
- `rtengine.rtp_timeout`: Consider a call dead if no RTP is received for this long (60 seconds).
- `rtengine.rtp_timeout_onhold`: Maximum limit in seconds for an onhold (1h).

## security

The following is the security section. Usage of the firewall subsection is described in [Firewalling](#):

```
security:
  firewall:
    enable: no
    logging:
      days_kept: '7'
      enable: yes
      file: /var/log/firewall.log
      tag: NGCPFW
    nat_rules4: ~
    nat_rules6: ~
    policies:
      forward: DROP
```

```

input: DROP
output: ACCEPT
rules4: ~
rules6: ~

```

- `security.firewall.enable`: Enable/disable iptables configuration and rule generation for IPv4 and IPv6 (default: no)
- `security.firewall.logging.days_kept`: Number of days logfiles are kept on the system before being deleted (log files are rotated daily, default: 7)
- `security.firewall.logging.enable`: Enables/disables logging of all packets dropped by Sipwise C5 firewall (default: yes)
- `security.firewall.logging.file`: File firewall log messages go to (default: `/var/log/firewall.log`)
- `security.firewall.logging.tag`: String prepended to all log messages (internally DROP is added to any tag indicating the action triggering the message, default: NGCPFW)
- `security.firewall.nat_rules4`: Optional list of IPv4 firewall rules added to table nat using iptables-persistent syntax (default: undef)
- `security.firewall.nat_rules6`: Optional list of IPv6 firewall rules added to table nat using iptables-persistent syntax (default: undef)
- `security.firewall.policies.forward`: Default policy for iptables FORWARD chain (default: DROP)
- `security.firewall.policies.input`: Default policy for iptables INPUT chain (default: DROP)
- `security.firewall.policies.output`: Default policy for iptables OUTPUT chain (default: ACCEPT)
- `security.firewall.rules4`: Optional list of IPv4 firewall rules added to table filter using iptables-persistent syntax (default: undef)
- `security.firewall.rules6`: Optional list of IPv6 firewall rules added to table filter using iptables-persistent syntax (default: undef)

## sems

The following is the SEMS section:

```

sems:
  bindport: 5080
  conference:
    enable: yes
    max_participants: 10
  debug: no
  highport: 50000
  lowport: 40001
  media_processor_threads: 10
  prepaid:
    enable: yes
  sbc:
    calltimer_enable: yes
    calltimer_max: 3600
    outbound_timeout: 6000
  profile:

```

```

- custom_header: []
  name: ngcp
- custom_header: []
  name: ngcp_cf
sdp_filter:
  codecs: PCMA,PCMU,telephone-event
  enable: yes
  mode: whitelist
session_timer:
  enable: yes
  max_timer: 7200
  min_timer: 90
  session_expires: 300
session_processor_threads: 10
vsc:
  auto_answer_code: '59'
  block_override_code: '80'
  blockinclir_code: '32'
  callback_last_caller_code: '74'
  callback_last_caller_confirmation_key: '3'
  callback_last_caller_interactive_code: '71'
  cf_disable_all_code: '96'
  cfb_code: '90'
  cfna_code: '93'
  cft_code: '92'
  cfu_code: '72'
  clir_code: '31'
  directed_pickup_code: '99'
  dnd_code: '78'
  enable: yes
  force_sendrecv_state: no
  last_number_redial_code: '95'
  park_code: '97'
  recent_calls_deletion_code: '20'
  reminder_code: '55'
  speedial_code: '50'
  unpark_code: '98'
  voicemail_deposit_code: '56'
  voicemail_number: '2000'
xmlrpcport: 8090

```

- b2b.conference.enable: Enable/Disable conference feature.
- b2b.conference.max\_participants: Sets the number of concurrent participant.
- b2b.highport: Maximum ports used by sems for RTP traffic.
- b2b.debug: Enable/Disable debug mode.
- b2b.lowport: Minimum ports used by sems for RTP traffic.
- b2b.prepaid.enable: Enable/Disable prepaid feature.
- b2b.sbc.calltimer\_max: Set the default maximum call duration. Note that this value can be overwritten in subscriber/customer/domain preferences setting max\_call\_duration parameter.

Attention: in case of call transfer done by the callee, with `max_call_duration` set, the timer will be restarted from 0 for the new transferred call.

- `b2b.sbc.outbound_timeout`: Set INVITE transaction timeout if the destination is not responding with provisional response message.
- `b2b.sbc.profile.name`: Profile's name where to add the custom headers in 'header\_list' config parameter. Supported values: `ngcp` and `ngcp_cf`.
- `b2b.sbc.profile.custom_header`: List of the custom headers that has to be whitelisted (default) by `sems sbc` in the corresponding profile.
- `b2b.sbc.session_timer.enable`: If set to "no" all session timer headers are stripped off without considering the session timer related configuration done via the web interface. If set to "yes" the system uses the subscriber/peer configurations values set on the web interface. If set to "transparent" no validation is performed on Session Timer headers, they are ignored by SEMS and therefore negotiated end-to-end.
- `b2b.vsc.*`: Define here the VSC codes.

## sms

This section provides configuration of **Short Message Service** on the NGCP. Description of the SMS module is provided earlier in this handbook [here](#).

In the below example you can see the default values of the configuration parameters.

```
sms:
  core:
    admin_port: '13000'
    smsbox_port: '13001'
  enable: no
  loglevel: '0'
  sendsms:
    max_parts_per_message: '5'
    port: '13002'
  smsc:
    dest_addr_npi: '1'
    dest_addr_ton: '1'
    enquire_link_interval: '58'
    host: 203.0.113.42
    id: default_smsc
    max_pending_submits: '10'
    no_dlr: yes
    password: password
    port: '2775'
    source_addr_npi: '1'
    source_addr_ton: '1'
    system_type: ''
    throughput: '5'
    transceiver_mode: '1'
    username: username
```

- `sms.core.admin_port`: Port number of admin interface of SMS core module (running on LB nodes).

- `sms.core.smsbox_port`: Port number used for internal communication between *bearerbox* module on LB nodes and *smsbox* module on PRX nodes. This is a listening port of the *bearerbox* module (running on LB nodes).
- `sms.enable`: Set to **yes** if you want to enable SMS module.
- `sms.loglevel`: Log level of SMS module; the default '0' will result in writing only the most important information into the log file.
- `sms.sendsms.max_parts_per_message`: If the SM needs to be sent as concatenated SM, this parameter sets the max. number of parts for a single (logical) message.
- `sms.sendsms.port`: Port number of *smsbox* module (running on PRX nodes).
- `sms.smsc.`: Parameters of the connection to an SMSC
  - `dest_addr_npi`: Telephony numbering plan indicator for the SM destination, as defined by standards (e.g. '1' stands for E.164)
  - `dest_addr_ton`: Type of number for the SM destination, as defined by standards (e.g. '1' stands for "international" format)
  - `enquire_link_interval`: Interval of SMSC link status check in seconds
  - `host`: IP address of the SMSC
  - `id`: An arbitrary string for identification of the SMSC; may be used in log files and for routing SMs.
  - `max_pending_submits`: The maximum number of outstanding (i.e. not acknowledged) SMPP operations between Sipwise C5 and SMSC. As a guideline it is recommended that no more than 10 (default) SMPP messages are outstanding at any time.
  - `no_dlr`: Do not request delivery report; when sending an SM and this parameter is set to **yes**, Sipwise C5 will not request DR for the message(s). May be required for some particular SMSCs, in order to avoid "Incorrect status report request parameter usage" error messages from the SMSC.
  - `password`: This is the password used for authentication on the SMSC.
  - `port`: Port number of the SMSC where Sipwise C5 will connect to.
  - `source_addr_npi`: Telephony numbering plan indicator for the SM source, as defined by standards (e.g. '1' stands for E.164)
  - `source_addr_ton`: Type of number for the SM source, as defined by standards (e.g. '1' stands for "international" format)
  - `system_type`: Defines the SMSC client category in which Sipwise C5 belongs to; defaults to "VMA" (Voice Mail Alert) when no value is given. (No need to set any value)
  - `throughput`: The max. number of messages per second that Sipwise C5 will send towards the SMSC. (Value type: float)
  - `transceiver_mode`: If set to **1** (yes / true), Sipwise C5 will attempt to use a TRANSCEIVER mode connection to the SMSC. It uses the standard transmit port of the SMSC for receiving SMs too.
  - `username`: This is the username used for authentication on the SMSC.

## snmpd

The following is the snmpd section:

```
snmpd:
```

```

agentx_timeout: 15
communities:
  - name: public
    sources:
      - localhost
trap_communities:
  - name: public
    targets:
      - localhost
traps:
  if:
    link: yes
  ucd:
    disk: yes
    exec: yes
    load: yes
    process: yes
    swap: yes

```

- `snmpd.agentx_timeout`: Sets the Agent X connection timeout, when communicating with a sub-agent (such as `ngcp-snmp-agent`).
- `snmpd.communities.\*`: Sets the SNMP community and sources. Entries (i.e. the `sources`) for a community (like `public` in the example) are in a list of hashes format, each line starting with "-" and followed by the name and a list of source addresses.
- `snmpd.trap_communities.\*`: Sets the SNMP TRAP community and destination for traps sent by NGCP. Format is the same as for `snmpd.communities`, but instead of `sources` it uses `targets`. If `snmptrapd` is enabled, it will be automatically configured to listen for any community specified as sending traps to a `localhost` target.
- `snmpd.traps.if.\*`: Enables/disables the emission of SNMP IF MIB traps.
- `snmpd.traps.ucd.\*`: Enables/disables the emission of SNMP UCD MIB traps.

### snmptrapd

The following is the `snmptrapd` section:

```

snmptrapd:
  enable: no

```

- `snmptrapd.enable`: Enable the `snmptrapd` daemon, to log any trap sent by the `snmpd` daemon into `/var/log/ngcp/snmp-trap.log`.

### snmpagent

The following is the SNMP Agent section:

```

snmpagent:
  debug: no
  retrospect_interval: 30

```

```
traps:
  origin: mgmt
  events:
    collective_check: yes
    database: yes
    ha_switchover: yes
    peering: yes
    process: yes
  alarms:
    database: yes
    ha_switchover: yes
    peering: yes
    process: yes
update_interval: '30'
```

- debug: Enables/disables debug output (that will be logged in `/var/log/ngcp/snmp-agent.log`)
- retrospect\_interval: Sets the interval the agent will use when looking into past fetched data.
- traps.origin: Sets the trap emission origin mode. The values can be one of 'legacy', 'mgmt' or 'distributed'.
- traps.events.\\*: Enables/disables emission of SNMP SIPWISE-NGCP-MONITOR-MIB event traps (based on state changes).
- traps.alarms.\\*: Enables/disables emission of SNMP SIPWISE-NGCP-ALARMS-MIB alarm traps (based on severities and clearances).
- update\_interval: Sets the interval in seconds used to update the fetched data.

## sshd

The following is the sshd section:

```
sshd:
  listen_addresses:
    - 0.0.0.0
```

- sshd: specify interface where SSHD should run on. By default sshd listens on all IPs found in network.yml with type 'ssh\_ext'. Unfortunately sshd can be limited to IPs only and not to interfaces. The current option makes it possible to specify allowed IPs (or all IPs with 0.0.0.0).

## sssd

The following is the sssd section:

```
sssd:
  enable: no
  ldap:
    host: localhost
    port: 636
    base_dn: ''
```

```
access_filter: '(objectClass=posixAccount)'
```

- `sssd.enable`: Enable/disable LDAP authentication via SSSD.
- `sssd.ldap.host`: The LDAP hostname to use. The 'localhost' default is there for lack of a better hostname, but it is not currently set up with any account information. This would usually be set to the organization LDAP.
- `sssd.ldap.port`: The LDAP port to use for the ldaps protocol, that is LDAP over TLS.
- `sssd.ldap.base_dn`: The LDAP base DN to use for searches.
- `sssd.ldap.access_filter`: The access filter to apply on searches. The default setting is intended to work for POSIX accounts, but depending on how the LDAP accounts are set up and on the site policies, another filter might be needed.

## sudo

The following is in the sudo section:

```
sudo:
  logging: no
  max_log_sessions: 0
```

- `logging`: enable/disable the I/O logging feature of sudo. See man page of 'sudoreplay(8)'.
- `max_log_sessions`: when I/O logging is enabled, specifies how many log sessions per individual user sudo should keep before it starts overwriting old ones. The default '0' means no limit.

## voisniff

The following is the voice sniffer section:

```
voisniff:
  admin_panel: yes
  daemon:
    custom_bpf: ''
    enable: yes
    filter:
      exclude:
        - active: '0'
          case_insensitive: '1'
          pattern: '\ncseq: *\d+ +(register|notify|options)'
      include: []
    sip_ports:
      - 5060
      - 5062
    interfaces:
      extra: []
      types:
        - sip_int
        - sip_ext
```

```

- rtp_ext
li_x1x2x3:
  call_id:
    del_patterns:
      - _pbx\-1(?:_[0-9]{1,10})?$
      - _b2b\-1(?:_[0-9]{1,10})?$
      - _xfer\-1(?:_[0-9]{1,10})?$
  captagent:
    cin_max: '3000'
    cin_min: '0'
    x2:
      threads: 20
  client_certificate: ''
  enable: no
  fix_checksums: no
  fragmented: no
  interface:
    excludes: []
  local_name: sipwise
  x1:
    port: '18090'
  x23:
    protocol: sipwise
mysql_dump:
  enable: yes
  max_query_len: 67108864
  num_threads: '4'
rtp_filter: yes
threads_per_interface: '2'
partitions:
  increment: '700000'
  keep: '10'

```

Parameters commonly used for call statistics retrievable on the web interface and for lawful interception:

- `voisniff.daemon.filter.exclude` and `voisniff.daemon.filter.include`: Additional filter to determine packets that need to be excluded from / included in capturing.
- `voisniff.daemon.enable`: Change to **yes** if you want `ngcp-voisniff` start at boot. Default is **no**.
- `voisniff.daemon.threads_per_interface`: Controls how many threads per enabled sniffing interface should be launched.

Parameters used only for call statistics:

- `voisniff.admin_panel`: Enable/Disable call statistics on Admin interface. Default: **no**.
- `voisniff.daemon.mysql_dump.enable`: Needs to be switched to **yes** to enable call statistics.

The parameters relevant to Lawful Interception are described in [Configuration of LI Service](#)

## ngcp-witnessd

The following is the ngcp-witnessd tool section:

```
witnessd:
  debug: no
  interval: ~
  gather:
    asr_ner_statistics: yes
    ha_node_force: no
    ha_node_state: yes
    kamilio_concurrent_calls: yes
    kamilio_dialog_active: yes
    kamilio_dialog_early: yes
    kamilio_dialog_incoming: yes
    kamilio_dialog_local: yes
    kamilio_dialog_outgoing: yes
    kamilio_dialog_relay: yes
    kamilio_shmem: yes
    kamilio_usrloc_regdevices: yes
    kamilio_usrloc_regusers: yes
    peering_groups: yes
    mta_queue_len: yes
    mysql_global_status: yes
    mysql_slave_status: yes
    oss_provisioned_subscribers: yes
    sip_responsiveness: yes
    sip_stats_num_packets: yes
    sip_stats_num_packets_perday: yes
    sip_stats_partition_size: yes
```

- `witnessd.interval`: The number of seconds between each data gathering iteration, when the value is undefined, the code will fallback to use `monitoring.interval`.
- `witnessd.gather.asr_ner_statistics`: Enable ASR/NER statistics data.
- `witnessd.gather.ha_node_force`: Enable data gathering, even if the High-Availability node status is not active.
- `witnessd.gather.ha_node_status`: Enable High-Availability node status data.
- `witnessd.gather.kamilio_*`: Enable Kamailio statistics data.
- `witnessd.gather.mta_queue_len`: Enable MTA (exim4) queue length data.
- `witnessd.gather.mysql_global_status`: Enable global MySQL data.
- `witnessd.gather.mysql_slave_status`: Enable slave (replication) MySQL data.
- `witnessd.gather.oss_provisioned_subscribers`: Enable OSS provisioned subscribers count data.
- `witnessd.gather.sip_*`: Enable SIP statistics data.

## www\_admin

The following is the WEB Admin interface (`www_admin`) section:

```
www_admin:
  apache:
    autoprov_port: 1444
    callingcard_features: 0
    callthru_features: 0
    conference_features: 1
    contactmail: adjust@example.org
    fastcgi_workers: 2
    fax_features: 1
    fees_csv:
      element_order:
        - source
        - destination
        - direction
        - zone
        - zone_detail
        - onpeak_init_rate
        - onpeak_init_interval
        - onpeak_follow_rate
        - onpeak_follow_interval
        - offpeak_init_rate
        - offpeak_init_interval
        - offpeak_follow_rate
        - offpeak_follow_interval
        - use_free_time
  http_admin:
    autoprov_port: 1444
    port: 1443
    serveradmin: support@sipwise.com
    servername: "\"myserver\""
    ssl_enable: yes
    sslcertfile: '/etc/ngcp-config/shared-files/ssl/myserver.crt'
    sslcertkeyfile: '/etc/ngcp-config/shared-files/ssl/myserver.key'
  http_csc:
    autoprov_bootstrap_port: 1445
    autoprov_port: 1444
    port: 443
    serveradmin: support@sipwise.com
    servername: "\"myserver\""
    ssl_enable: yes
    sslcertfile: '/etc/ngcp-config/shared-files/ssl/myserver.crt'
    sslcertkeyfile: '/etc/ngcp-config/shared-files/ssl/myserver.key'
  logging:
    apache:
      acc:
        facility: daemon
        identity: oss
        level: info
      err:
        facility: local7
        level: info
```

```
security:
  admin_ldap:
    dn_format: ~
    manager_dn: ~
    manager_password: ~
    uri: localhost
  jwt:
    expires: 36000
  login:
    ban_enable: yes
    ban_increment: 300
    ban_max_time: 3600
    ban_min_time: 300
    max_attempts: 5
  password:
    allow_recovery: 0
    max_length: 40
    min_length: 12
    musthave_digit: 3
    musthave_lowercase: 3
    musthave_specialchar: 3
    musthave_uppercase: 3
    sip_autogenerate: 0
    sip_expose_subadmin: 1
    sip_keep_last_used: 12
    sip_validate: no
    web_autogenerate: 0
    web_expose_subadmin: 1
    web_keep_last_used: 12
    web_max_age_days: 0
    web_validate: no
    rsa_private_key_file: /etc/ngcp-config/shared-files/ngcp-
panel/rsa_private_key.pem
    rsa_public_key_file: /etc/ngcp-config/shared-files/ngcp-
panel/rsa_public_key.pem
    voucher_iv: ...
    voucher_key: ...
  speed_dial_vsc_presets:
    vsc:
      - '*0'
      - '*1'
      - '*2'
      - '*3'
      - '*4'
      - '*5'
      - '*6'
      - '*7'
      - '*8'
      - '*9'
```

- `www_admin.http_admin.*`: Define the Administration interface and certificates.

- `www_admin.http_csc.*`: Define the Customers interface and certificates.
- `www_admin.contactmail`: Email to show in the GUI's Error page.

## constants.yml Overview

`/etc/ngcp-config/constants.yml` is one of the main configuration files that contains important (static) configuration parameters, like Sipwise C5 system-user data.

### CAUTION

Sipwise C5 platform administrator should not change content of `constants.yml` file unless absolutely necessary. Please contact Sipwise Support before changing any of the parameters within the `constants.yml` file!

## maintenance.yml Overview

`/etc/ngcp-config/maintenance.yml` is one of the main configuration files that contains the maintenance configuration option.

### general

The following is the general section:

```
general:
  maintenance: no
```

- `general.maintenance`: maintenance mode necessary for safe upgrades.

## network.yml Overview

`/etc/ngcp-config/network.yml` is one of the main configuration files that contains network-related configuration parameters, like IP addresses and roles of the node(s) in Sipwise C5 system.

The next example shows a part of the `network.yml` configuration file. Explanation of all the configuration parameters is provided in [Network Configuration](#) section of the handbook.

### Sample host configuration for Sipwise C5

A PRO would look like:

```
sp1:
  dbnode: '1'
  eth0:
    dns_nameservers:
      - 192.168.51.30
      - 192.168.51.31
    gateway: 192.168.22.1
    hwaddr: 06:1e:bc:e2:ec:fb
    ip: 10.0.2.15
    netmask: 255.255.255.0
    shared_ip: ~
    shared_v6ip: ~
```

```
type:
  - web_ext
  - ssh_ext
  - web_int
eth1:
  hwaddr: 6e:7f:3a:f9:db:1f
  ip: 192.168.255.251
  netmask: 255.255.255.248
  shared_ip:
    - 192.168.255.250
  shared_v6ip: ~
  type:
    - ha_int
    - ssh_ext
eth2:
  ip: 10.15.20.107
  netmask: 255.255.255.0
  shared_ip:
    - 10.15.20.151
  type:
    - ssh_ext
    - web_ext
    - web_int
    - sip_ext
    - rtp_ext
    - mon_ext
interfaces:
  - lo
  - eth0
  - eth1
  - eth2
lo:
  advertised_ip: []
  cluster_sets:
    - default
  hwaddr: 00:00:00:00:00:00
  ip: 127.0.0.1
  netmask: 255.0.0.0
  shared_ip: []
  shared_v6ip: []
  type:
    - sip_int
    - web_ext
    - web_int
    - aux_ext
    - ssh_ext
    - api_int
  v6ip: ':::1'
peer: sp2
role:
  - proxy
  - lb
```

```

    - mgmt
    - rtp
    - db
  status: 'online'
  hosts_common:
  etc_hosts_global_extra_entries:
  - 10.100.1.1 server-1 server-1.internal.example.com
  - 10.100.1.2 server-2 server-2.internal.example.com

```

A CARRIER would look like:

```

web01a:
  bond0:
    bond_miimon: '100'
    bond_mode: active-backup
    bond_slaves: 'eth0 eth1'
    hwaddr: 00:00:00:00:00:00
    ip: 192.168.1.2
    netmask: 255.255.255.0
    shared_ip:
      - 192.168.1.1
    type:
      - boot_int
  eth0:
    hwaddr: 00:00:00:00:00:00
  eth1:
    hwaddr: 00:00:00:00:00:00
  interfaces:
    - vlan11
    - vlan666
    - vlan35
    - vlan100
    - vlan80
    - vlan90
    - vlan15
    - vlan20
    - lo
    - eth0
    - eth1
    - bond0
  lo:
    advertised_ip: []
    hwaddr: 00:00:00:00:00:00
    ip: 127.0.0.1
    netmask: 255.0.0.0
    shared_ip: []
    shared_v6ip: []
    type:
      - ssh_ext
      - api_int
    v6ip: ':::1'

```

```
peer: web01b
role:
  - mgmt
status: 'online'
vlan20:
  advertised_ip: []
  hwaddr: 00:00:00:00:00:00
  ip: 172.31.3.75
  netmask: 255.255.255.240
  shared_ip:
    - 172.31.3.74
  type:
    - web_int
  vlan_raw_device: bond0
  post_up:
    - 'route add -host 172.30.172.247 gw 172.31.3.65 dev vlan20'
vlan100:
  hwaddr: 00:0a:f7:8d:32:ec
  ip: 172.31.3.5
  netmask: 255.255.255.224
  shared_ip:
    - 172.31.3.4
  type:
    - ha_int
    - web_int
    - ssh_ext
  vlan_raw_device: bond0
vlan11:
  dns_nameservers:
    - 172.31.3.244
    - 192.168.56.11
    - 192.168.57.11
  gateway: 172.31.3.33
  hwaddr: 00:00:00:00:00:00
  ip: 172.31.3.37
  netmask: 255.255.255.224
  shared_ip:
    - 172.31.3.36
  shared_v6ip: []
  type:
    - mon_ext
    - ssh_ext
  vlan_raw_device: bond0
vlan15:
  hwaddr: 00:00:00:00:00:00
  ip: 192.168.181.201
  netmask: 255.255.255.0
  post_up:
    - 'route add -net 172.25.240.0/24 gw 192.168.181.1 dev vlan15'
    - 'route add -net 192.168.6.0/24 gw 192.168.181.1 dev vlan15'
  shared_ip:
    - 192.168.181.200
```

```
    type:
      - ssh_ext
      - web_int
      - mon_ext
    vlan_raw_device: bond0
vlan35:
  hwaddr: 00:00:00:00:00:00
  ip: 172.31.3.101
  netmask: 255.255.255.240
  shared_ip:
    - 172.31.3.100
  type:
    - sip_int
  vlan_raw_device: bond0
vlan666:
  hwaddr: 00:00:00:00:00:00
  ip: 46.5.10.37
  netmask: 255.255.255.240
  shared_ip:
    - 46.5.10.36
  type:
    - web_ext
  vlan_raw_device: bond0
vlan80:
  hwaddr: 00:00:00:00:00:00
  ip: 172.31.3.237
  netmask: 255.255.255.248
  shared_ip:
    - 172.31.3.236
  type:
    - phone_ext
    - web_ext
  vlan_raw_device: bond0
  post_up:
    - 'ip route add default via 172.31.3.233 dev vlan80 table
phones_ext'
    - 'ip rule add from 172.31.3.236 lookup phones_ext prio 1000'
vlan90:
  hwaddr: 00:00:00:00:00:00
  ip: 46.5.10.53
  netmask: 255.255.255.248
  post_up:
    - 'route add -host 77.244.249.93 gw 46.5.10.49 dev vlan90'
  shared_ip:
    - 46.5.10.52
  type:
    - repos_ext
  vlan_raw_device: bond0
hosts_common:
  etc_hosts_global_extra_entries:
    - 10.100.1.1 server-1 server-1.internal.example.com
```

```
- 10.100.1.2 server-2 server-2.internal.example.com
```

**NOTE**

The option 'hosts\_common' is optional and it allows administrator to provide extra entries in /etc/hosts.

The administrator can create new entries in network.yml to specify extra entries for the file /etc/hosts. One entry is global and two per-host, one of which is local only for the host, and the other overrides global for this host. These entries will be appended without further processing.

The example of adding new entries using 'ngcpcfg set':

```
ngcpcfg set --diff /etc/ngcp-config/network.yml \
  hosts_common.etc_hosts_global_extra_entries='["10.100.1.1 server-1
  server-1.internal.example.com","10.100.1.2 server-2 server-
  2.internal.example.com"]'
```

Global is useful if the entries are to be added to all hosts. These probably make more sense in most set-ups.

Per-host local is useful if the entries are only to be added to some node, but not needed or convenient to add to all of them.

Per-host override of the global config is useful if the global entries are to be added to a potentially large number of nodes and to be excluded only in a few of them, to not have to do the contrary (duplicate entries in many hosts except a couple).

Example of modifications to network.yml:

```
hosts_common:
  etc_hosts_global_extra_entries:
  - 10.100.1.1 server-1 server-1.internal.example.com
  - 10.100.1.2 server-2 server-2.internal.example.com
hosts:
  db01b:
    etc_hosts_local_extra_entries:
    - 127.0.1.1 local-alias-1.db01b
    - 127.0.2.1 local-alias-2.db01b
    - 172.30.52.180 db01b.example.com
    ...
  web01a:
    etc_hosts_local_extra_entries:
    - 127.0.1.1 local-alias-1.web01a
    - 127.0.2.1 local-alias-2.web01a
    - 172.30.52.168 web01a.example.com
    etc_hosts_global_extra_entries:
    - 10.100.1.1 server-1 server-1.internal.example.com
    ...
```

With this, the output in /etc/hosts for *db01b* will be:

```
# local extra entries for host 'db01b'
127.0.1.1 local-alias-1.db01b
127.0.2.1 local-alias-2.db01b
172.30.52.180 db01b.example.com

# global extra entries
10.100.1.1 server-1 server-1.internal.example.com
10.100.2.1 server-2 server-2.internal.example.com
```

the content in `/etc/hosts` on `web01a` will be:

```
# local extra entries for host 'web01a'
127.0.1.1 local-alias-1.web01a
127.0.2.1 local-alias-2.web01a
172.30.52.168 web01a.example.com

# global extra entries overridden for host 'web01a'
10.100.1.1 server-1 server-1.internal.example.com
```

## Appendix E: Sipwise C5 Authentication Tokens

Sipwise C5 defines many system users and their authentication credentials in order to provide the necessary security level for its components / services.

### Authentication with Password

#### Credentials of System Users

The list of system users that use password for their authentication is stored in `/etc/ngcp-config/constants.yml` configuration file.

#### CAUTION

The table below shows the default usernames. Unless you have a good reason, please do not change the credentials in the file because this may render the related service unavailable!

Table 45. List of system users with password authentication

Purpose / Use case	Username	Configuration parameters: username / password
<b>Generic system users</b>		
Config parameter root: credentials.		
Autoprovisioning of Yealink devices	N/A	n/a / <code>autoprov.yealink.p</code>
Faxserver manager	<code>faxserver</code>	<code>faxserver.manager.u / faxserver.manager.p</code>
Fileshare service generic authentication	<code>comx</code>	<code>fileshare.authentication.u / fileshare.authentication.p</code>
Fileshare service app authentication	<code>app</code>	<code>fileshare.simple_upload.u / fileshare.simple_upload.p</code>
HA proxy service	N/A	n/a / <code>haproxy.p</code>
Key for Kamailio load balancer topology hiding	N/A	n/a / <code>kamailio.lb.topoh_key.p</code>
Password for Kamailio proxy UAC encryption	N/A	n/a / <code>kamailio.proxy.uaccryptpw.p</code>
LDAP server access	N/A	n/a / <code>ldap.root.p</code>
REST API internal access	<code>system</code>	<code>rest_api.auth_system.u / rest_api.auth_system.p</code>
<b>Users in MySQL database</b>		
Config parameter root: credentials.mysql.		
Asterisk voicemail application	<code>asterisk</code>	<code>asterisk.u / asterisk.p</code>
CDR exporter	<code>exporter</code>	<code>cdrexport.u / cdrexport.p</code>
Monitoring subsystem	<code>nagios</code>	<code>monitoring.u / monitoring.p</code>
Cleanuptools (DB purging) utility	<code>dbcleaner</code>	<code>cleanuptools.u / cleanuptools.p</code>

Purpose / Use case	Username	Configuration parameters: username / password
Debian system maintenance	debian-sys-maint	debian.u / debian.p
Fileshare service	fileshare	fileshare.u / fileshare.p
Kamailio read-write DB access	kamailio	kamailio.u / kamailio.p
Kamailio read-only DB access	kamailioro	kamailioro.u / kamailioro.p
LDAP access	ldap	ldap.u / ldap.p
Mediator (CDR pre-processing) service	mediator	mediator.u / mediator.p
Provisioning SOAP interface	soap	provisioning.u / provisioning.p
Rate-o-mat (CDR rating) service	rateomat	rateomat.u / rateomat.p
DB replicator	replicator	replicator.u / replicator.p
Rsyslog service	rsyslog	rsyslog.u / rsyslog.p
RTPEngine service	rtpeengine	rtpeengine.u / rtpeengine.p
B2BUA pre-paid module	sems_prepaid	sems.u / sems.p
Voisniff call capturing service	voisniff	voisniff.u / voisniff.p
<b>SMS service credentials</b>		
Config parameter root: sms.		
SMS core module admin password	N/A	core.admin_password
SMS API access token	N/A	panel_api_token
SMS sending	sipwise	sendsms.username / sendsms.password

### Credentials for External Sipwise C5 Interfaces

Some Sipwise C5 services used by external entities and some external services that NGCP needs to connect to make use of password based authentication. The list of credentials is stored in /etc/ngcp-config/config.yml configuration file.

#### CAUTION

The table below shows the default usernames. Changing some of them may render the related service unavailable!

Table 46. List of credentials used for external Sipwise C5 interfaces

Purpose / Use case	Username	Configuration parameters: username / password
Access to exported events (EDR files)	youruser	eventexport.transfer.username / eventexport.transfer.password
RTPEngine Homer RTCP monitoring service	2001	rtpeengine.homer.capture_id
Voisniff Homer LI (Lawful Interception) service	2002	voisniff.daemon.homer.capt_id

Purpose / Use case	Username	Configuration parameters: username / password
SOAP API	ngcpsoap	ossbss.htpasswd[n].user / ossbss.htpasswd[n].pass
Sipwise C5 access to SMSC interface	username	sms.smsc.username / sms.smsc.password
TURN access for Sipwise C5 standard RTP media	turnuser	turnserver.user / turnserver.pass

## Authentication with PKI (Keys and Certificates)

### Keys and Certificates for Using Sipwise C5 Services

Some system users of Sipwise C5 authenticate themselves using PKI (*Public Key Infrastructure*), i.e. keys and certificates. The location of those keys and certificates may be selected in `/etc/ngcp-config/config.yml` file, using the configuration parameters as listed in the following table.

Table 47. List of keys and certificates used in authentication

Purpose / Use case	Configuration parameters: certificate / key
Device autoprovisioning server's CA certificate	autoprov.server.ca_certfile
Device autoprovisioning server's own credentials	autoprov.server.server_certfile / autoprov.server.server_keyfile
Load-balancer SIP service TLS connection server side credentials	kamailio.lb.tls.domains.<domain>.sslcertfile / kamailio.lb.tls.domains.<domain>.sslcertkeyfile
Generic HTTPS access server side credentials	ossbss.apache.sslcertfile / ossbss.apache.sslcertkeyfile
REST API access server side credentials	ossbss.apache.restapi.sslcertfile / ossbss.apache.restapi.sslcertkeyfile
Mobile Push notification client side credentials for iOS apps	pushd.apns.certificate
Mobile Push notification (local) server's server side credentials	pushd.sslcertfile / pushd.sslcertkeyfile
RTPEngine service HTTPS credentials	rtpengine.https.crt / rtpengine.https.key
TURN server's server side credentials	turnserver.sslcertfile / turnserver.sslcertkeyfile
LI (Lawful Interception) X2 / X3 interface client credentials	voisniff.daemon.li_x1x2x3.client_certificate
HTTPS-based admin interface ("Sipwise C5 web panel") server side credentials	www_admin.http_admin.sslcertfile / www_admin.http_admin.sslcertkeyfile

Purpose / Use case	Configuration parameters: certificate / key
HTTPS-based CSC (Customer Self-Care) interface server side credentials	<code>www_admin.http_csc.sslcertfile / www_admin.http_csc.sslcertkeyfile</code>
HTTPS-based internal API server side credentials	<code>www_admin.http_system.sslcertfile / www_admin.http_system.sslcertkeyfile</code>

## Location of Certificates

The following locations of keys and certificates are in use:

- /etc/ngcp-config/shared-files/ssl
- /etc/ssl/certs
- /etc/ssl/private
- /etc/kamailio

# Appendix F: MariaDB encryption

## Overview

MariaDB encryption support (officially called as "Data-at-Rest") enables innodb files, tables and binlogs data encryption so that if copied over the data is not usable without the master key. All the data accessed or modified by clients is encrypted/decrypted on the fly and transparent for the users. The feature comes with a price of 3% to 5% MariaDB performance loss (depending on the hardware, and CPU in particular).

## Configuration

There are new options in constants.yml

```
mysql:
  encryption:
    enable: yes
    encrypt_binlog: yes
    key:
1;a356c82422a9031f2e472047ad8220eeea257d611849fbdc9f75b49933f75241
    threads: 1
```

**NOTE:** all changes in the configuration section will cause the MariaDB server to restart when ngpcfg templates are applied.

- `mysql.encryption.enable`: Switch encryption on/off. Values: 'yes','no', Default: 'yes'. When enabled, all tables are being encrypted, it takes from a few seconds to several minutes for MariaDB to encrypt all the data (depending on the overall size) and the encryption procedure is performed in the background, while all the data continues to be fully accessible. Also all new tables are created encrypted by default and it is not possible to disable encryption for specific tables as the encryption is 'forced'.
- `mysql.encryption.encrypt_binlog`: Encrypt binlogs. Values: 'yes','no', Default: 'yes'. While it is preferred to have this option enabled by default, for scenarios where binlog files need to be parsed, this option can be turned off. It is also possible to use `mysqlbinlog` with `--read-from-remote-server` option to read encrypted binlogs.
- `mysql.encryption.key`: Encryption key. The value is randomly generated during the `cfg-schema` upgrade when the option is added into `constants.yml`. The key is located in `/etc/mysql/keyfile` and normally **MUST NOT** be changed. Changing or losing the key permanently will render all the MariaDB tablespaces data (databases/tables) unusable.
- `mysql.encryption.threads`: Amount of encryption threads. Default: 1 How many MariaDB encryption threads should be running, this value depends on how many tables are created/removed or the encryption keys are rotated.

## What is not encrypted

- slow-queries log
- `mysqld.err` log
- general queries log, if enabled

## Data restoration remarks

- When restoring data from an sql backup from another platform it is safe to do that as the currently used 'encryption\_key' (inside my.cnf) is not affected this way.
- When copying constants.yml file from another platform and the encryption is enabled, the current 'mysql.encryption.key' (inside constants.yml) must be restored in constants.yml to the same one the MariaDB server is originally started with or it will fail to start otherwise after ngcpcfg apply.

## Appendix G: Disk partitioning

This chapter documents possible disk partitioning on Sipwise C5 available after installation the Sipwise C5. It should be helpful to understand the overall disk partitioning schema.

### Supported IO drives

At the moment the following drives are supported: HDD, SSD, and NVMe. We recommend installing NVMe type SSD storage for the best performance. Otherwise, install SATA SSDs for an average performance as SATA hard disks are a good option only for test/development purpose.

The exact model and size depend on the type of the system and the load. We recommend running the initial performance test on the selected hardware before going into production.

### Hardware vs. software RAID

Depending on the specific hardware specification, Sipwise will configure either RAID 1 for CARRIER or RAID 10 for PRO (HW-RAID, usually for installations with HDDs), or software RAID (SW-RAID, generally for installations with SSDs).

### The default disk partitions

The Sipwise C5 supports the modern concept of installing several releases side by side. The ability to switch between the releases simplifies software upgrades and enables rollbacks. You can find all the benefits here [here](#).

The new partitioning logic is simple. The 'code' of services (e.g., kamailio, MariaDB) is separated from the 'data' (e.g., databases, CDR files) generated and processed by the 'code', and is located in a different partition of the disk. Additionally, there are two partitions for 'code' with different services versions. This way, the version of the code can be switched very quickly, by rebooting the system. The 'data' partition will be the same for both versions of the 'code', and it will always be mounted and ready to be used before the services start.

New partition layout:

NAME	MAJ:MIN	RM	SIZE	RO	TYPE	MOUNTPPOINT	
sda	8:0	0	xG	0	disk		# Your disk
with size X Gb							
-sda1	8:1	0	1M	0	part		# BIOS legacy boot
-sda2	8:2	0	486M	0	part	/boot/efi	# UEFI boot
`-sda3	8:3	0	yG	0	part		# LVM partition
`-md0	9:0	0	yG	0	raid1		# SW RAID (if requested)
-ngcp-root	253:0	0	10G	0	lvm	/	# 'code' partition
-ngcp-fallback	253:1	0	10G	0	lvm		# 'fallback' partition
`-ngcp-data	253:3	0	zG	0	lvm	/ngcp-data	# 'data' partition

space

# unassigned

- 1st partition: 1M BIOS boot, for BIOS/GPT (legacy) boot
  - this allows fallback to grub-pc package (This partition must have its GUID set to 21686148-6449-6E6F-744E-656564454649 To switch to grub-pc, boot from a rescue/live CD, set to bios\_grub with parted, then install grub to disk, so it properly embeds core.img)
- 2nd partition: ~500MB EFI System, for UEFI/GPT boot
  - used as /boot/efi, if EFI support is available
- 3rd partition: LVM that is divided into:
  - /dev/mapper/ngcp-root with 10GB (rootfs target)
  - /dev/mapper/ngcp-fallback with 10GB (for rollback/install/upgrade)
  - 10% or >=500MB (whichever is bigger) of the remaining space is unassigned to allow LVM snapshots during maintenance
  - /dev/mapper/ngcp-data is the **/ngcp-data** partition with the rest of the disk space for the whole platform 'data' (e.g., databases, CDR files, logs, etc.)

**NOTE**

The installer can only boot from GPT and does not support ms-dos partitions anymore. The legacy 'BIOS' systems can also boot from GPT, while (U)EFI systems can only boot from GPT (and not from BIOS/legacy boot).

**UEFI**

UEFI installation is supported. The dedicated UEFI partition has been created on the disk during the installation (being the second partition in the list).

**Swap partition vs. file****IMPORTANT**

The Sipwise C5 performance heavily depends on the IO operations, hence if Swap is used (either the Swap file and/or the Swap partition), the performance might deteriorate. We highly recommend increasing RAM if the platform uses Swap during normal operation.

The Swap partition is no longer in use. The Sipwise C5 has been migrated to the Swap file on the 'data' partition. It gives the following benefits:

- more space is now available for the 'root', 'rollback' and 'data' partitions.
- the Swap file size can be easily changed on the fly (if necessary).
- the Swap file can be migrated to a new location easily: create a new Swap file with the necessary size and location using the 'mkswap' command and activate the new Swap file with 'swapon'. Add the new location to /etc/fstab. Now, you can deactivate the old swapfile with 'swapoff' and remove it to release the disk space.
- The main reason for the Swap partition usage, used to be 'data fragmentation' on hard disk drives (HDDs) and old types of filesystems. For modern SSD drives, the fragmentation issue is irrelevant and the 'ext4' filesystem does not require manual defragmentation either. The free space on fast SSDs is more important nowadays, as it allows storing more 'data'.

# Appendix H: Faxserver Configuration

For an overview of Faxserver architecture and features, please see the [Faxserver](#) chapter.

## Faxserver Components

### Enabling Faxserver

In order to configure functions of Sipwise C5 Faxserver one needs to update the main NGCP configuration file `/etc/ngcp-config/config.yml` with the correct fax options:

```
faxserver:
  enable: yes
  fail_attempts: '3'
  fail_retry_secs: '60'
  keep_failed_fax: yes
  keep_failed_fax_days: '60'
  keep_received_fax: yes
  keep_received_fax_days: '60'
  keep_sent_fax: yes
  keep_sent_fax_days: '60'
  mail_from: 'Sipwise C5 FaxServer <voipfax@ngcp.sipwise.local>'
```

Parameters are:

- `enable`: must be `yes` to enable Faxserver
- `fail_...:` the number and timeout of fax sending retrials
- `keep_...:` fax retention definitions: enabling and length in days
- `mail_from`: the *From* header in the e-mail that is sent by Fax2Mail feature when a fax is received

#### IMPORTANT

Ensure that in `network.yml` the `api_int` interface is assigned to the appropriate network interface or on a CARRIER to a VLAN of the node with the `mgmt` role. Usually, this is the same network interface or on a CARRIER the VLAN where the `ha_int` interface is assigned to. The `api_int` interface must be removed from all other nodes.

## Fax Templates Configuration

One needs to update `/etc/ngcp-config/templates/etc/ngcp-faxserver/faxserver.conf.tt2` if he wants to use custom content in the fax and e-mail templates that are used by Faxserver to generate the actual fax or e-mail. This may be done under the "User templates" section in the file.

### Applying new Faxserver configuration

Once the above mentioned configuration files have been modified the new settings must be applied:

```
ngcpcfg apply 'Configured fax server'
ngcpcfg push all
```

## Fax Services Configuration per Subscriber

Fax services must be explicitly activated for subscribers before they can send or receive faxes. This activation and the custom settings may be set on Sipwise C5 Web panel in the following way (as an administrator):

- Go to *Subscribers* and find the subscriber that you want to modify settings for
- Click on *Preferences* button
- Select *FaxFeatures*

In both sections *Fax2Mail* and *SendFax* and *Mail2Fax* there is a field: *Active*. This must be changed from no to yes if the particular fax service must be activated.

When fax services have been activated the user sees a summary of settings in *FaxFeatures* section on his Preferences page:

Voicemail and Voicebox		
Fax Features		
<b>Fax2Mail and Sendfax</b>		
Name	Value	
Name in Fax Header for Sendfax		
Active	yes	
Destinations	subscriber1@example.org as TIFF	
<b>Mail2Fax</b>		
Name	Value	
Active	yes	
Secret Key (empty=disabled)		
Secret Key Renew	never	
Last Secret Key Modify Time		
Secret Key Renew Notify		
ACL	regex from_email <u>subscriber1@example.org</u> and received_from any to <u>^4399.+</u> destination	
<b>Speed Dial</b>		

Figure 232. Fax Settings

Details of Fax2Mail, SendFax and Mail2Fax settings are described in subsequent paragraphs.

### Fax2Mail and SendFax Settings

- Name in Fax Header for SendFax: optional field that contains the subscribers name on faxes sent from the Web panel directly
- Destinations: e-mail addresses and selections of notification items that define about which event and where an e-mail is sent; this is a list of such definitions

**Edit destinations** ✕

Destination Email

File Type

Deliver Incoming Faxes

Deliver Outgoing Faxes

Receive Reports

Figure 233. Fax2Mail Destination

The parameters for a destination are as follows:

- Destination Email: the e-mail address where the notification must be sent
- File Type: file format of faxes attached to e-mails
- Deliver Incoming Faxes: select this in order to receive incoming faxes in e-mail
- Deliver Outgoing Faxes: select this in order to receive a report about sent faxes
- Receive Reports: select this in order to receive reports about success / failure of fax transmissions

## Mail2Fax Settings

A subscriber can restrict access to his Mail2Fax service with some methods, those can also be combined:

- using a *secret key* that is only known to him, and is inserted in every mail that he sends to Sipwise C5 to be forwarded as fax
- using an *access control list (ACL)* that determines from which endpoint and for which destination a mail-to-fax is accepted by Sipwise C5 platform
- Secret Key: the secret key used to validate the sender of an e-mail; this is optional. Not used if left empty;
- Secret Key Renew: secret key renewal period; Sipwise C5 platform will enforce renewal of the secret key when the defined time has elapsed;

- Last Secret Key Modify Time: information about the last secret key modification time;
- Secret Key Renew Notify: an e-mail address where the notification about secret key modification is sent;
- ACL: access control list, see the details below; this is a list of access control rules. This is mandatory otherwise service will deny accepting any e-mail.

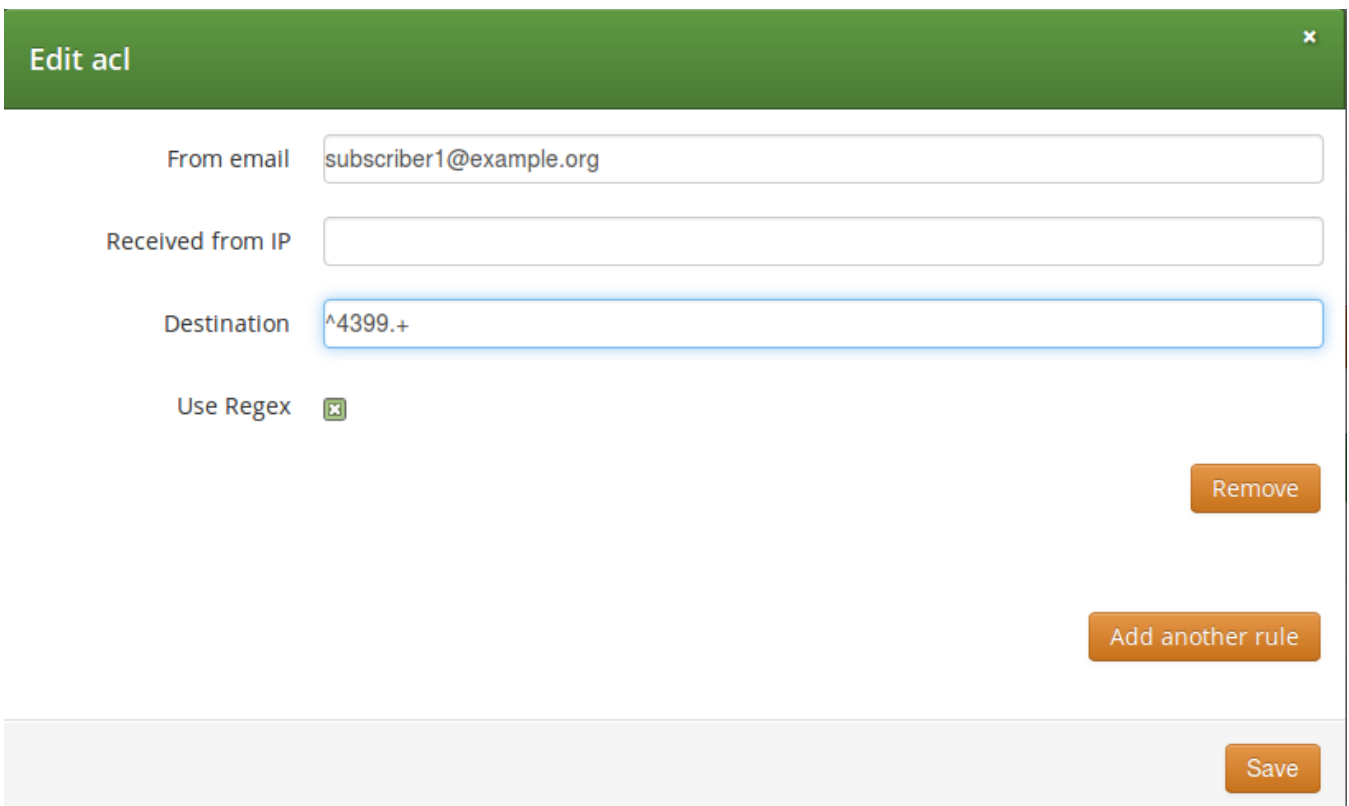

The screenshot shows a web interface for editing an Access Control List (ACL) rule. The interface is titled "Edit acl" in a green header. Below the header, there are four input fields: "From email" containing "subscriber1@example.org", "Received from IP" which is empty, "Destination" containing "^4399.+", and "Use Regex" which has a checked checkbox. To the right of the "Destination" field is an orange "Remove" button. Below the "Destination" field is an orange "Add another rule" button. At the bottom right of the form is an orange "Save" button.

Figure 234. Mail2Fax Access Control List

The parameters for access control rules:

- From email: this sender is allowed to use Mail2Fax service. It can be either an email address or a regular expression (if 'Use Regex' checkbox is ticked). Note: Only the first **To** email header will be considered to obtain the destination subscriber.
- Received from IP: this IP address or host name must be present in any of the **Received** e-mail headers. It can also be a regular expression if 'Use Regex' checkbox is ticked.
- Destination: either a complete phone number in E.164 format, or a regular expression ("Use Regex" checkbox must be ticked) that may define a range of numbers. Examples: "4313334445" as a single number; "^4399.+" as a regular expression: all destinations starting with "4399".

### CAUTION

When ACL is not defined then Mail2Fax service will deny accepting any e-mail for sending faxes!

## Sending Fax from Web Panel

A subscriber can log in to his *Customer Self Care* website and send faxes directly from there. In order to do this, one needs to do the following:

- Go to *Settings Web Fax* page

**TIP** | The list of received faxes is also available here.

- Press *Send Fax* button to start entering data, such as recipient and content for the fax being sent:

The screenshot shows a 'Create Fax' dialog box with the following fields and values:

- Destination Number:** 43993003
- Quality:** Normal
- Page header:** Test fax
- Content:** This is the plain text content, but there will also be an attachment.
- File:** handbook-pro.pdf (with a 'Browse...' button)
- Send:** An orange button at the bottom right.

Figure 235. Sending Fax from Web Panel

Both plain text message and attached files can be sent in the fax. First page(s) will contain the plain text message and the content of attached files will follow that.

## Faxserver Mail2Fax Configuration

Using Sipwise C5 Faxserver's Mail2Fax service requires the configuration of Sipwise C5's local mail server that is *Exim*. It has to be configured in a way that it can receive mails from outside of the server, because *Exim* by default listens only on the local interfaces for incoming mails.

### Exim Configuration

The Sipwise C5 platform administrator must reconfigure *Exim* in order to enable receiving e-mails for fax sending:

```
sudoedit /etc/ngcp-config/config.yml # edit section 'email:' according
to your needs
sudo ngcpcfg apply 'adjust exim4 / MTA configuration'
```

**PLEASE NOTE:** When entering configuration data the following points must be kept in mind:

- operation mode has to be set to "mail sent by smarthost; no local mail"
- "mail2fax.example.org" must be added to accepted domains, where "example.org" is the domain name of Sipwise C5 platform operator

## DNS Configuration

It is necessary to add a subdomain starting as mail2fax. to the list of domain names. That is where the faxes will be sent by users to trigger Mail2Fax service.

### TIP

Alternatively, edit `/etc/ngcp-config/templates/etc/exim4/conf.d/router/g99_mail2fax.tt2` file and adjust it to your personal preferences. Although this is not recommended and should only be done by Sipwise support engineers.

## Sending Fax Using E-mail Clients

When sending an e-mail that should be converted to a fax, there are some points to keep in mind so that Faxserver properly processes the e-mail.

- **To header:**
  - must contain the subscriber's number who is sending the fax, as the username part of the mail address
  - must contain the specific domain starting with mail2fax.
- **Subject header:** must contain the fax destination number
- **Body** should consist of plain text data
- Adding **attachments** is possible, but only plain text and PDF formats are supported

## Secret Key

In order to use the "secret key" access control feature, it should be either put in the first row of the e-mail body followed by an empty line, or included as a plain text attachment. Once it has been validated, it will be removed from the email.

### IMPORTANT

Either add the secret key to the body, or attach it. Never do both as only one will be recognized and removed, leaving the other one to be sent as part of the fax.

## Mail Example

Provided there is a subscriber on Sipwise C5 platform with the 43130111 number, the destination fax is 43130222 and the secret key is "MySecretKey":

```
From: User Name <username@example.org>
To: 43130111@mail2fax.example.org
Subject: 43130222
-----
MySecretKey

This is a test fax.
```

Cheers

## Managing Faxes via the REST API

It is possible to send and receive faxes and configure fax settings using the built-in REST API interface.

In subsequent sections you can find examples of using the API for sending, receiving faxes and changing fax settings.

### Configuring Fax Settings

#### Retrieving Fax Settings

The following example retrieves the fax settings for the subscriber with ID 3.

```
Method: GET
Content-Type: application/hal+json

https://127.0.0.1:1443/api/faxserversettings/3
```

The output format is as follows (only the relevant output data is shown):

```
"active" : true,
  "destinations" : [
    {
      "destination" : "user@company.com",
      "filetype" : "PDF14",
      "incoming" : true,
      "outgoing" : true,
      "status" : true
    }
  ],
  "name" : null,
  "password" : null
```

#### Updating Fax Settings

The following example updates a specific parameter. Namely, it deactivates the fax feature for the subscriber with ID 3.

```
Method: PATCH
Content-Type: application/json-patch+json

https://127.0.0.1:1443/api/faxserversettings/3

--data-binary '[ { "op" : "replace", "path" : "/active", "value" : 0 } ]'
```

## Sending a Fax

The following request sends a PDF file located at /tmp/test\_fax.pdf as fax to 431110002 from the subscriber with ID 3.

```
Method: POST
Content-Type: multipart/form-data

https://127.0.0.1:1443/api/faxes/

--form 'json={"destination" : "431110002", "subscriber_id" : 3}' --form
'faxfile=@/tmp/test_fax.pdf'
```

## Receiving a Fax

All received faxes are stored on the server and can be retrieved on demand. You can retrieve a stored fax by following these steps:

1. Firstly, obtain the internal ID of the fax:

```
Method: GET
Content-Type: application/json

https://127.0.0.1:1443/api/faxes/3
```

This request returns the list of stored faxes for the subscriber with ID 3. One of the available faxes is returned like this:

```
"callee" : "431110002",
"caller" : "431110001",
"direction" : "out",
"duration" : "0",
"filename" : "d9799276-b7d9-454f-98c3-714edf7e3072.tif",
"id" : 5,
"pages" : "1",
"quality" : "8031x7700",
"reason" : "Normal Clearing / SIP 200 OK [1/3]",
"signal_rate" : "14400",
"status" : "SUCCESS",
"subscriber_id" : 1,
"time" : "2016-07-30 09:49:59"
```

2. Now, to retrieve the fax with ID 5, use the following request:

```
Method: GET
Content-Type: application/hal+json
```

```
https://127.0.0.1:1443/api/faxrecordings/5
```

By default, the fax is in the TIFF format. It is also possible to request it in a different format. To retrieve the same fax in PDF14, use the following request:

```
https://127.0.0.1:1443/api/faxrecordings/5?format=pdf14
```

## Configuring Mail2Fax Settings

The configuration of Mail2Fax settings via the REST API is similar to the fax settings configuration.

### Retrieving Mail2Fax Configuration

To get the Mail2Fax configuration for the subscriber with ID 3, use the following request:

```
Method: GET
Content-Type: application/hal+json

https://127.0.0.1:1443/api/mailtofaxsettings/3
```

The output format is as follows (only the relevant output data is shown):

```
"acl" : [],
"active" : false,
"secret_key" : "secretkeypassword",
"secret_key_renew" : "daily",
"secret_renew_notify" : [
  {
    "destination" : "user1@company.com"
  }
]
```

### Updating Mail2Fax Configuration

The following set of requests changes the Mail2Fax configuration with new secret key settings.

- Secret key value:

```
Method: PATCH
Content-Type: application/json-patch+json

https://127.0.0.1:1443/api/faxserversettings/3

--data-binary '[ { "op" : "replace", "path" : "/secret_key", "value" :
"newsecretkeypassword" } ]'
```

- Secret key renewal interval:

```
Method: PATCH
Content-Type: application/json-patch+json

--data-binary '[ { "op" : "replace", "path" : "/secret_key_renew",
"value" : "monthly" } ]'
```

- List of email addresses that receive the automatic secret key update notifications:

```
Method: PATCH
Content-Type: application/json-patch+json

--data-binary '[ { "op" : "replace", "path" : "/secret_renew_notify",
"value" : [ { "destination": "user2@company.com" }, { "destination":
"user3@company.com" } ] } ]'
```

## Using Advanced Faxserver and Mail2Fax Settings via the REST API

On Sipwise C5 REST API documentation web page you can find the complete list of available Faxserver and Mail2Fax configuration parameters: [https://<ngcp\\_ip\\_address>:1443/api](https://<ngcp_ip_address>:1443/api)

### IMPORTANT

The information on the web page is relevant for your platform version and may change in next releases.

After visiting the API documentation main page, you can find the following entries related to Faxserver operations:

- Faxes ([https://<ngcp\\_ip\\_address>:1443/api/#faxes](https://<ngcp_ip_address>:1443/api/#faxes))
- FaxRecordings ([https://<ngcp\\_ip\\_address>:1443/api/#faxrecordings](https://<ngcp_ip_address>:1443/api/#faxrecordings))
- FaxserverSettings ([https://<ngcp\\_ip\\_address>:1443/api/#faxserversettings](https://<ngcp_ip_address>:1443/api/#faxserversettings))

## Troubleshooting

The following log file may be used to check Faxserver functionality: `/var/log/ngcp/faxserver.log`

### Session ID (SID)

Faxserver stores basic information about each processed fax in a session file. The most important element within this set of data is the *Session ID* (SID) that uniquely identifies a fax throughout its lifetime.

Session ID is a long hexadecimal string (a kind of UUID) that can be read from the above mentioned Faxserver logfile, and which itself is used also as the filename in files that belong to a specific sent / received fax. An example:

```
root@sp1:~# cat /ngcp-data/spool/faxserver/failed/1e480167-5de6-4cc2-
948b-de58d1a0bb8c.err
```

```
created: 2016-09-06 04:41:32
caller: 111111111
callee: 222222222
file: 1e480167-5de6-4cc2-948b-de58d1a0bb8c.tif
sid: 1e480167-5de6-4cc2-948b-de58d1a0bb8c
dir: out
attempts: 0
fail_attempts: 3
fail_retry_secs: 60
quality: normal
status: FAILED
error: Internal error
modified: 2016-09-06 17:41:30
```

```
root@sp1:~#
```

The data element sid is the session ID. Other important elements are:

- caller and callee: these are probably searched for when trying to figure out what happened to a specific fax transmission, if you don't know the SID
- dir: direction of fax transmission: 'in'coming or 'out'going or 'mtf' for mail-to-fax
- status: shows success or failure
- error: the error cause in case of failed faxes

### Fax Storage Location

Faxserver stores all of its processed faxes at the path: /ngcp-data/spool/faxserver/... Within that directory the most relevant subdirectories are failed and completed that store the SID file and the fax itself in TIFF format of those faxes that failed or were successful, respectively.

# Appendix I: Storage Node

## Overview

Storage is an optional feature that enables one or more pairs of 'storage' nodes that are especially configured for intense DB writing and storing data.

On the 'storage' nodes MariaDB comes with dedicated configuration tuned for extensive writing. Currently 'storage' nodes can be used to redirect and store 'voisniff' traffic from the PRO nodes or the CARRIER 'db' nodes.

From the running processes perspective on the 'storage' nodes there is only MariaDB running (as well as usual mandatory processes like 'rsyslog', 'ntpd', 'ssh' and alike).

## Deployment

'storage' nodes are not part of the default deployment and must be deployed manually using the NGCP deployment procedure.

Nodes must be deployed with type **stor**.

Default and internal names are:

- stor01 (vip)
- stor01a
- stor01b

Multiple 'storage' pairs are supported ('stor02', 'stor03').

## Configuration

Once deployed you can move 'stor\_int' type in the network.yml to the interface where the traffic is expected on. It is a good practice to have a dedicated interface for that so that it is separated with SIP/RTP/HA traffic.

## Appendix J: NGCP Internals

This chapter documents internals of Sipwise C5 that should not be usually needed, but might be helpful to understand the overall system.

### Pending reboot marker

The Sipwise C5 has the ability to mark a pending reboot for any server, using the file `/run/reboot-required`. As soon as the file exists, several components will report about a pending reboot to the end-user. The following components report about a pending reboot right now: `ngcp-status`, `ngcpcfg status`, `motd`, `ngcp-upgrade`. Also, `ngcp-upgrade` will NOT allow proceeding with an upgrade if it notices a pending reboot. It might affect `rtengine` dkms module building if there is a pending reboot requested by a newly installed kernel, etc.

### Redis id constants

The list of current Sipwise C5 Redis DB IDs:

Service	central (role 'db')	pair	Release	Ticket	Description
<b>sems</b>	-	0	mr3.7.1+	-	HA switchover
<b>rtengine</b>	-	1	mr3.7.1+	-	HA switchover
<b>proxy</b>	2	-	mr3.7.1+	-	Counter of hunting groups
<b>proxy</b>	3	-	mr3.7.1+	-	Concurrent dialog counters
<b>proxy</b>	-	4	mr3.7.1+	-	List of keys of the central counters
<b>prosody</b>	5	-	mr3.7.1 - mr14.1	-	XMPP cluster (obsolete)
<b>sems-pbx</b>	-	6	mr3.7 - mr9.5	-	Reserved (obsolete)
<b>sems</b>	7	-	mr4.1.1+	MT#12707	Sems malicious_call app
<b>captagent</b>	-	8	mr4.1 - mr7.1	-	Reserved (obsolete)
<b>monitoring</b>	9	-	mr4.3 - mr5.5	-	Reserved (obsolete)
<b>proxy</b>	10	-	mr4.3+	MT#16079	SIP Loop detection
<b>ngcp-panel sessions</b>	-	19	mr6.3+	TT#35523	Panel login sessions
<b>proxy usrloc</b>	20	-	mr6.2+	TT#32971	SIP registrations

Service	central (role 'db')	pair	Release	Ticket	Description
proxy acc	-	21	mr6.2+	TT#32971	Accounting records
proxy auth	-	22	mr6.2+	TT#32971	Subscriber data
proxy dialog	-	23	mr6.2+	TT#34100	Dialog data
lb topos	-	24	mr6.5+	TT#40617	Topos data
proxy b2b	25	-	mr8.0+	TT#64404	B2B in use by each subscriber
proxy 181 HIH	26	-	mr8.5+	TT#89301	HIH stored for 181 messages
lb debug_uri	-	27	mr9.1+	TT#93950	Send SIP messages to inactive node
websocket	-	30	mr7.1+	TT#49703	Reserved (future use)
websocket monitors	-	31	mr7.1+	TT#49703	Monitors
websocket subscriptions	-	32	mr7.1+	TT#49703	Subscriptions
proxy evapi	33	-	mr7.1+	TT#49703	Call event data
proxy push	34	-	mr10.0+	TT#131255	Suspended transactions
ngcp-task-agent	40	-	mr11.5+	MT#57970	ngcp-task-agent connection

## Default ports

The list of current Sipwise C5 default ports for NGCP services, in addition to the standard protocol ports. Most of these can be changed in 'config.yml' or 'constants.yml', and as such the canonical port registry for a system is the `/etc/services` file on that system.

Service	Port	Protocol
approx-ro	9998	tcp
approx-rw	9999	tcp
asterisk-ctrl	5038	tcp
asterisk-sip	5070	udp
corosync	5405	udp
ffproxy	8082	tcp
freeswitch	5085	tcp
glusterd	24007	tcp

<b>Service</b>	<b>Port</b>	<b>Protocol</b>
grafana	4000	tcp
haproxy-admin	8080	tcp
kamailio-ctrl	5012	tcp
kamailio-sip	5062	tcp udp
kannel-admin	13000	tcp
kannel-smsbox	13001	tcp
kannel-smssend	13002	tcp
ngcp-faxserver	8877	tcp
ngcp-ipxe	3000	tcp
ngcp-lnpd-rpc	8096	tcp
ngcp-lnpd-sip	5095	udp
ngcp-mariadb-central	3306	tcp
ngcp-mariadb-local	3306	tcp
ngcp-mariadb-pair	3306	tcp
ngcp-panel-admin	1443	tcp
ngcp-panel-api	1442	tcp
ngcp-pushd-fcgi	45061	tcp
ngcp-pushd-http	45059	tcp
ngcp-pushd	45060	tcp
ngcp-redis-central	6379	tcp
ngcp-rest-api	2443	tcp
ngcp-websocket	3443	tcp
ngcp-witnessd	9800	tcp
nginx-status	8081	tcp
pbx-autoprov-cisco	1447	tcp
pbx-autoprov-https	1444	tcp
pbx-autoprov-http	1445	tcp
prometheus-haproxy-exporter	9101	tcp
prometheus-mysqld-exporter	9104	tcp
prometheus-nginx-exporter	9113	tcp
prometheus-node-exporter	9100	tcp
prometheus-process-exporter	9256	tcp
prometheus-redis-exporter	9121	tcp
prometheus	9090	tcp
rtpengine-cli	2224	tcp

Service	Port	Protocol
rtengine-ctrl	2223	udp
rtengine-https	2226	tcp
rtengine-http	2225	tcp
sems-b2b	5080	tcp udp
sems-monit	5048	udp
sems-xmlrpc	8090	tcp
turn	443	tcp udp
turn-tls	443	tcp udp
voisniff-xmlrpc	5180	tcp

## Monitoring database metrics

### Prometheus monitoring metrics

The *Prometheus* monitoring database contains time series metrics of several monitoring sources.

The 'ngcp\_' namespace is provided by *ngcp-witnessd*, and here are some of its current metrics subnamespaces:

ngcp_node_	Cluster node information.
ngcp_tls_certs_	TLS certificate information.
ngcp_monit_	Monit supervised processes information.
ngcp_mail_	MTA information.
ngcp_mysql_	MySQL database information.
ngcp_kamailio_	Kamailio statistics information.
ngcp_peer_	Peering information.
ngcp_sip_	SIP statistics information.
ngcp_cdr_	CDR statistics information.

The 'ngcp\_node\_' namespace consists of the following metrics:

ngcp_node_active	Cluster node HA state (boolean: 1/0).
ngcp_node_ha_proc_state	Cluster node GCS/CRM process state (boolean: stopped/running).
ngcp_node_ha_host_state	Cluster node host state (boolean: up/down).
ngcp_node_ha_node_state	Cluster node HA state (ngcp-check-active -q).

The 'ngcp\_tls\_certs\_' namespace consists of the following metrics:

ngcp_tls_certs_expires_on	TLS certificate expiration information; the value is the expiration date as seconds since the epoch, with labels: <b>filename</b> of the certificate or bundle; <b>fingerprint</b> of the certificate, relevant on bundles).
---------------------------	--

The 'ngcp\_monit\_' namespace consists of the following metrics:

ngcp_monit_proc_info	Information about the process, the value is always 1, with labels: <b>name</b> , <b>pid</b> , <b>ppid</b> , <b>proc_status</b> , <b>monit_status</b> , <b>service_cur_status</b> is the current systemd service status, <b>service_exp_status</b> is the expected systemd service status.
ngcp_monit_proc_children	The number of children.
ngcp_monit_proc_uptime	The process uptime in seconds.
ngcp_monit_proc_cpu_ratio	The CPU usage in for this process.
ngcp_monit_proc_cpu_total_ratio	The CPU usage in for the process group.
ngcp_monit_proc_memory_bytes	The memory in bytes for this process.
ngcp_monit_proc_memory_total_bytes	The memory in bytes for the process group.
ngcp_monit_proc_port_response_seconds	The monitored port response in seconds.
ngcp_monit_proc_sock_response_seconds	The monitored socket response in seconds.
ngcp_monit_proc_data_collected	The timestamp when the data was collected.

The 'ngcp\_mysql\_' namespace consists of the following metrics:

ngcp_mysql_queries_per_second_average	Average of queries per second.
ngcp_mysql_global_status_innodb_buffer_pool_pages_total	Total number of InnoDB buffer pool pages.
ngcp_mysql_global_status_innodb_buffer_pool_pages_free	Number of free InnoDB buffer pool pages.
ngcp_mysql_global_status_innodb_buffer_pool_pages_dirty	Number of dirty InnoDB buffer pool pages.
ngcp_mysql_global_status_commands_total	Total number of commands used.
ngcp_mysql_slave_status_slave_io_running	Whether the IO slave is running.
ngcp_mysql_slave_status_slave_sql_running	Whether the SQL slave is running.
ngcp_mysql_slave_status_seconds_behind_master	Seconds behind master replication.
ngcp_mysql_slave_status_last_io_errno	Last IO error description.
ngcp_mysql_slave_status_last_sql_errno	Last SQL error description.

The 'ngcp\_peer\_' namespace consists of the following metrics:

ngcp_peer_group_info	Peer group information; the value is the group ID, and contains group <b>name</b> , <b>priority</b> and <b>description</b> labels.
ngcp_peer_host_info	Peer host information; the value is the host ID, and contains host <b>name</b> , <b>ip</b> , and <b>group_id</b> labels.
ngcp_peer_host_status	Peer host status, where the value is -1=unknown on standby node, 0=unknown, 1=admin-down, 2=admin-up, 3=pending, 4=down, 5=up; contains the host <b>id</b> label.
ngcp_peer_host_cc_inout	Peer host concurrent call (in/out) counter; contains the host <b>id</b> label.
ngcp_peer_host_cc_out	Peer host concurrent call (in) counter; contains the host <b>id</b> label.

The 'ngcp\_sip\_' namespaces consists of the following metrics:

ngcp_sip_answer_seizure_ratio	Current ASR (Answer Seizure Ratio).
ngcp_sip_concurrent_calls	Number of concurrent calls.
ngcp_sip_dialog_active	Number of calls currently in active dialog stage.
ngcp_sip_dialog_early	Number of calls currently in early media dialog stage.
ngcp_sip_dialog_incoming	Number of calls currently in incoming dialog stage.
ngcp_sip_dialog_local	Number of calls currently in local dialog stage.
ngcp_sip_dialog_outgoing	Number of calls currently in outgoing dialog stage.
ngcp_sip_dialog_relay	Number of calls currently in relay dialog stage.
ngcp_sip_network_efficiency_ratio	Current NER (Network Efficiency Ratio).
ngcp_sip_packets_total	Total number of SIP packets in storage.
ngcp_sip_packets_total_perday	Total number of SIP packets since 00:00 today.
ngcp_sip_partition_bytes	Size of packets partition.
ngcp_sip_provisioned_subscribers	Provisioned subscribers.
ngcp_sip_registered_devices	Registered devices.
ngcp_sip_registered_subscribers	Registered subscribers.
ngcp_sip_responsiveness_seconds	SIP server responsiveness in seconds.

The 'ngcp\_cdr\_' namespaces consists of the following metrics:

ngcp_cdr_total	Total number of generated CDRs.
ngcp_cdr_rated_total	Total number of rated CDRs.

The 'node\_' namespace is provided by the *prometheus-node-exporter*.

The 'namedprocess\_' namespace is provided by the *prometheus-process-exporter*.

The 'redis\_' namespace is provided by the *prometheus-redis-exporter*.

The 'mysql\_' and 'mysqld\_' namespaces are provided by the *prometheus-mysqld-exporter*.

The 'nginx\_' and 'nginxexporter\_' namespaces are provided by the *prometheus-nginx-exporter*.

The 'haproxy\_' namespace is provided by the *prometheus-haproxy-exporter*.

The 'rtpengine\_' namespace is provided by *rtpengine* itself.

The 'go\_', 'process\_' and 'promhttp\_' namespaces are provided by exporters based on the Prometheus Golang libraries and export introspecting metrics for the exporters themselves.

The 'flag\_', 'up\_', 'promscrape\_', 'scrape\_', 'vm\_', 'vminsert\_' and 'vmselect\_' namespaces are provided by *victoria-metrics*.

## NGCP Preferences

### Tables

Currently available tables for preferences are

provisioning.voip_preferences	contains all available preferences, do not contain user data.
provisioning.voip_preference_group	contains preference group names, so the preferences can be put into groups.
provisioning.voip_preferences_enum	contains enum values for preferences, do not contain user data.

The following tables contain user data and depend on voip\_preferences and optionally on voip\_preferences\_enum:

provisioning.voip_dev_preferences	PBX device model preferences
provisioning.voip_devprof_preferences	PBX device profile preferences
provisioning.voip_dom_preferences	domain preferences, replicated by triggers to kamailio.dom_preferences
provisioning.voip_contract_preferences	customer preferences, replicated by triggers to kamailio.contract_preferences
provisioning.voip_peer_preferences	peering server preferences, replicated by triggers to kamailio.peer_preferences
provisioning.voip_prof_preferences	subscriber profile preferences
provisioning.voip_reseller_preferences	reseller preferences
provisioning.voip_usr_preferences	subscriber preferences, replicated by triggers to kamailio.usr_preferences

### Columns

Columns for table 'provisioning.voip\_preferences'

id	primary key, used in user tables as the foreign key
voip_preference_groups_id	preference group id
attribute	preference name
label	tooltip that can be used as a mouseover tooltip on the UI
type	0 - 'string', 1 - 'integer'/'boolean'
max_occur	how many preferences with the name are allowed 0: list, 1: only one
usr_pref	defines if the preference can be used in subscribers
prof_pref	defines if the preference can be used in subscriber profiles
dom_pref	defines if the preference can be used in domains
peer_pref	defines if the preference can be used in peering servers
contract_pref	defines if the preference can be used in customers
contract_location_pref	defines if the preference can be used in customer locations
dev_pref	defines if the preference can be used in PBX device models
devprof_pref	defines if the preference can be used in PBX device profiles
fielddev_pref	defines if the preference can be used in PBX devices that are assigned to a subscriber
modify_timestamp	preference last modification time
internal	the preference is for internal use only and not shown in the UI/API
expose_to_customer	indicates that the preference can be read/modified by 'subscriberadmin' role
data_type	data type 'enum', 'boolean', 'int', 'string'
read_only	ready only flag
description	long description of the preference
dynamic	set to 1 if it is a custom preference that is created by a user (usually for a PBX device model that requires specific preferences) but can be used for all preferences when needed
reseller_pref	defines if the preference can be used in resellers
expose_to_subscriber	indicates that the preference can be read/modified by 'subscriber' role

## Enum

All tables are in database "provisioning".

So called "enum preferences" allow a fixed set of possible values, an enumeration, for preferences. Following the differences between other preferences are described.

Setting the attribute "data\_type" of table "voip\_preferences" to "enum" marks a preferences as an enum. The list of possible options is stored in table "voip\_preferences\_enum".

Columns for table 'provisioning.voip\_preferences\_enum' are:

id	primary key
preference_id	Reference to table voip_preferences.
label	A label to be displayed in frontends.
value	Value that will be written to voip_lusr
dom	<i>peer_preferences.value if it is NOT NULL. Will not be written if it IS NULL. This can be used to implement a "default value" for a preference that is visible in frontends as such (will be listed first if nothing is actually selected), but will not be written to voiplusr</i>
dom	<i>peer_preferences.value. Usually forcing a domain or peer default. Should also be named unambiguous (e.g. "use domain default"). (Note: Therefore will also not be written to any kamailio table.)</i>
usr_pref	Flag if this is to be used for usr preferences.
dom_pref	Flag if this is to be used for dom preferences.
peer_pref	Flag if this is to be used for peer preferences.
default_val	Flag indicating if this should be used as a default value when creating new entities or introducing new enum preferences (both done via triggers). (Note: For this to work, value must also be set.)

Relevant triggers:

enum_update	Propagates changes of voip_preferences_enum.value to voip_lusr	dom	peer_preferences.value
enum_set_default	Will create entries for default values when adding a new enum preference. The default value is the tuple from voip_preferences_enum WHERE default_val=1 AND value NOT NULL.	voip_dom_crepl_trig	The trigger will set possible default values (same condition as for enum_set_default) when creating new domains.

voip_phost_crepl_trig	The trigger will set possible default values (same condition as for enum_set_default) when creating new peers.	voip_sub_crepl_trig	The trigger will set possible default values (same condition as for enum_set_default) when creating new subscribers.
-----------------------	--	---------------------	--

Find a usage example in a section in *db-schema/db\_scripts/diff/9086.up*.

## Appendix K: Kamailio pv\_headers module

This chapter documents the kamailio "pv\_headers" module.

### Module overview

This module enables storing all headers in XAVP to freely modify them in the kamailio logic and only apply them once when it's time for the packet to be routed outside. The main goal of the module is to offload the intermediate header processing into the XAVP dynamic container as well as provide with high level methods and pseudovariables to simplify SIP message header modifications.

In few words:

- as soon as a SIP message enters the proxy, kamailio reads all the headers (using the function "pv\_collect\_headers()") and stores them in an XAVP called "headers".
- starting from this point all the header changes are directly performed on the "headers" XAVP. For example the From header is available at '\$xavp(headers[0]From[0])'.
- right before the SIP message leaves the proxy, kamailio writes back all the headers changes (using the function "pv\_apply\_headers()").

RURI and the headers listed in the module parameter "skip\_headers" are left untouched and not saved in the XAVP. Therefore they should be handled in the usual way.

### Template changes

As described before in the upgrade procedures, the module is enabled by default in kamailio proxy and all the templates have been already updated to use this new logic. Before proceeding with the upgrade, it is essential that the customtt/patchtt files you have in place are updated to this new format.

Here some few examples of what has been changed in the proxy templates:

- variables \$fu, \$fU, \$fd, \$fn, \$ft have been substituted by \$x\_fu, \$x\_fU, \$x\_fd, \$x\_fn, \$x\_ft
- variables \$tu, \$tU, \$td, \$tn, \$tt have been substituted by \$x\_tu, \$x\_tU, \$x\_td, \$x\_tn, \$x\_tt
- variables \$rr, \$rs have been substituted by \$x\_rr, \$x\_rs
- variables \$ua have been substituted by \$x\_hdr(User-Agent)
- variables \$ai have been substituted by \$x\_hdr(P-Asserted-Identity)
- variables \$pU, \$pd have been substituted by \$x\_hdr(P-Preferred-Identity)
- variables \$re have been substituted by \$x\_hdr(Remote-Party-ID)
- variables \$di have been substituted by \$x\_hdr(Diversion)
- variables \$ct have been substituted by \$x\_hdr(Contact)
- \$hdr("name") has been substituted by \$x\_hdr("name")
- is\_present\_hf("name") has been substituted by \$x\_hdr(name)!= \$null
- remove\_hf("name") has been substituted by pv\_remove\_header("name") function or \$(x\_hdr(name)[\*]) = \$null
- append\_hf("name: value\r\n") has been substituted by pv\_append\_header("name", "value") / pv\_modify\_header("name", "value") functions or \$(x\_hdr(name)[\*]) = value

- `t_check_status(code)` has been substituted by `$T_reply_code == code`
- `save("location")` has been updated in `save("location", "0x00", "$x_tu")`
- `sd_lookup("speed_dial")` has been updated in `sd_lookup("speed_dial", $x_fu)`
- added `pv_collect_headers()` and `pv_reset_headers()` functions in the dedicated `ROUTE_COLLECT_HDR` route
- added `pv_apply_headers()` function in the dedicated `ROUTE_APPLY_HDR` route
- added `pv_reset_headers()` function in the following routing sections

## Module documentation

### Parameters

#### **xavp\_name (string)**

Name of the XAVP where the collected headers are stored.

Default: headers

```
modparam("pv_headers", "xavp_name", "headers")
```

#### Result:

```
$xavp(headers[0]=>From)
$xavp(headers[0]=>To)
$xavp(headers[0]=>Call-ID)
....
```

#### **skip\_headers (string)**

A comma separated headers list that must be excluded from processing (they are skipped when `pv_apply_headers()` changes the sip message headers). If the parameter is not set then the "Default" list is used. If the parameter is set to an empty string then all the sip message headers are processed.

Default: Record-Route,Via,Route,Content-Length,Max-Forwards

#### **split\_headers (string)**

A comma separated headers list that must be split into multi headers if their value is a comma separated list. If the parameter is not set then the "Default" is used. If the parameter is set to an empty string then no headers are split.

Default: None

```
modparam("pv_headers", "split_headers", "Diversion")
```

#### Result:

```
Received Diversion header:
Diversion:
<user1@test.local>,<user2@test.local>,<user3@test.local>
```

```

After split:
    Diversion: <user1@test.local>
    Diversion: <user2@test.local>
    Diversion: <user3@test.local>
Becomes handy if used together with pv_modify_header() or
pv_remove_header()
to change or remove value 2 for instance.

```

## Functions

### **pv\_collect\_headers()**

This function collects all headers from the message into the XAVP. It should be used preferably just when the sip message is received by kamailio.

Returns:

- 1 - on success
- -1 - if there were errors

### **pv\_apply\_headers()**

This function applies the current XAVP headers state to the real headers and should be called only once per branch when the message is about to leave kamailio.

The following rules apply:

- all headers in the XAVP except for ones provided in the "skip\_headers" parameter and From/To are recreated in the sip message.
- From/To headers are processed by the uac module if it is loaded.
- From/To headers are not changed in the reply messages.
- headers with NULL value are removed if exist in the sip message.
- the initial order of the sip headers is preserved.

Usage:

```

if (pv_apply_headers())
{
    "success"
}
else
{
    "errors"
}

```

### **pv\_reset\_headers()**

This function resets the current XAVP headers list and enables pv\_collect\_headers() and pv\_apply\_headers() to be called again in the same branch.

Usage:

```
if (pv_reset_headers())
{
    "success"
}
else
{
    "errors"
}
```

### **pv\_check\_header(hname)**

This function checks if the header already exists in the XAVP. It can be freely called from anywhere, but only after `pv_collect_headers()`.

Usage:

```
if (pv_check_header(hname))
{
    "exists"
}
else
{
    "does not exist"
}
```

### **pv\_append\_header(hname, hvalue)**

This function appends a new header into the XAVP. It can be freely called from anywhere, but only after `pv_collect_headers()`. Please note that subsequent "pv\_append\_header" calls will result in multiple headers. If the provided "hvalue" is \$null then the header is added into the XAVP but it is not going to be added into the message.

Usage:

```
if (pv_append_header(hname, hvalue))
{
    "appended"
}
else
{
    "errors"
}
```

### **pv\_modify\_header(hname, hvalue)**

This function modifies an existing header in the XAVP. It can be freely called from anywhere, but only after `pv_collect_headers()`. Please note that if the header does not exist it will be explicitly appended. If

there are multiple headers with the same name only the first one will be affected. If the provided header value is \$null then the header is modified in the XAVP then it is removed from the sip message when `pv_apply_headers()` is called.

Usage:

```
if (pv_modify_header(hname, hvalue))
{
    "modified"
}
else
{
    "errors"
}
```

### **pv\_modify\_header(hname, idx, hvalue)**

This function works similar to `pv_modify_header(hname, hvalue)` but should be used when there are multiple headers with the same name one of them to be modified. Index order is top to bottom.

Usage:

```
if (pv_modify_header(hname, idx, hvalue))
{
    "modified"
}
else
{
    "errors"
}
```

### **pv\_remove\_header(hname)**

This function removes an existing header from the XAVP. It can be freely called from anywhere, but only after `pv_collect_headers()`. If there are multiple headers with the same name all of them are removed. It returns -1 if the header does not exist.

Usage:

```
if (pv_remove_header(hname, hvalue))
{
    "removed"
}
else
{
    "does not exist or errors"
}
```

### **pv\_remove\_header(hname, idx, hvalue)**

This function works similar to `pv_remove_header(hname, hvalue)` but should be used when there are multiple headers with the same name one of them to be removed. Index order is top to bottom.

Usage:

```
if (pv_remove_header(hname, idx, hvalue))
{
    "removed"
}
else
{
    "does not exist or errors"
}
```

## Pseudovariables

### `$x_hdr`

This pseudovariable is used to append/modify/remove headers by their name and can be used instead of the `pv_append_header()`, `pv_modify_header()`, `pv_remove_header()` functions.

Usage:

- append header "X-Header" with value "example". NOTE: It always appends a header, even there is already one with the same name

```
$x_hdr(X-Header) = "example";
```

- modify header "X-Header" with index 0. Returns an error if there is no such index

```
$(x_hdr(X-Header)[0]) = "example";
```

- remove all occurrences of header "X-Header" and append one with value "example"

```
$(x_hdr(X-Header)[*]) = "example";
```

- remove header "X-Header" with index 2 (if there are multiple headers). Returns an error if there is no such index

```
$(x_hdr(X-Header)[2]) = $null;
```

- remove all occurrences of the header. Does not produce an error if there is no such header

```
$(x_hdr(X-Header)[*]) = $null;
```

- retrieve a value of header "X-Header" with index 0, otherwise \$null

```
$var(test) = $x_hdr(X-Header);
```

- retrieve a value of header "X-Header" with index 0 otherwise \$null

```
$var(test) = $x_hdr(X-Header)[*];
```

- retrieve a value of header "X-Header" with index 2 otherwise \$null

```
$var(test) = $(x_hdr(X-Header)[2]);
```

### **\$x\_fu, \$x\_tu**

These pseudovariables are used to modify/retrieve the "From" and "To" headers.

Usage:

- modify the header

```
$x_fu = "User1 <440001@example.local>";
```

- retrieve a value of the header

```
$var(test) = $x_fu;
```

- \$x\_tu usage is the same

### **\$x\_fU, \$x\_tU**

These pseudovariables are used to modify/retrieve the username part of the "From" and "To" headers.

Usage:

- modify the username part

```
$x_fU = "440001";
```

- retrieve the username part

```
$var(test) = $x_fU;
```

- \$x\_tU usage is the same

### **\$x\_fd, \$x\_td**

These pseudovariabes are used to modify/retrieve the domain part of the "From" and "To" headers.

Usage:

- modify the domain part

```
$x_fd = "example.local";
```

- retrieve the domain part

```
$var(test) = $x_fd;
```

- \$x\_td usage is the same

### **\$x\_fn, \$x\_tn**

These pseudovariabes are used to modify/retrieve the display part of the "From" and "To" headers.

Usage:

- modify the username part

```
$x_fn = "User1";
```

- retrieve the domain part

```
$var(test) = $x_fn;
```

- \$x\_tn usage is the same

### **\$x\_ft, \$x\_tt**

These pseudovariabes are used to retrieve the tag part of the "From" and "To" headers.

Usage:

- retrieve the tag part

```
$var(test) = $x_ft;
```

- \$x\_tt usage is the same

### **\$x\_rs, \$x\_rr**

These pseudovariabes are used to modify/retrieve or change "status" and "code" of the SIP reply

NOTE: Only messages with reply status > 300 can be changed as well as reply status 1xx and 2xx cannot be set

Usage:

- modify the reply status

```
$x_rs = 486
```

- retrieve the reply status

```
$var(test) = $x_rs;
```

- modify the reply reason

```
$x_rr = "Custom Reason"
```

- retrieve the reply reason

```
$var(test) = $x_rr;
```

## Appendix L: Extra Configuration Scenarios

### AudioCodes devices workaround

Old AudioCodes devices suffer from a problem where they replace 127.0.0.1 address in Record-Route headers (added by Sipwise C5's internal components) with the device's IP address. Supposedly, the whole range of AudioCodes devices with a firmware version below 6.8.X are affected. As a workaround, you may enable the topos feature to stop sending Record-Route headers out. To achieve this, execute the following commands:

```
ngcpcfg set /etc/ngcp-config/config.yml
kamilio.lb.security.topos.enable=yes
ngcpcfg apply 'enable topos for audiocodes devs workaround'
```

### "Debug Proxy" for troubleshooting

#### IMPORTANT

This functionality only makes sense on Sipwise C5 CARRIER appliance environment that has an inactive proxy node available.

In order to troubleshoot/debug/capture a scenario, the "debug proxy" allows defining a list of "debug subscribers" that will be matched against From/To headers for every SIP message on a specific lb node. If matched that SIP message will be delivered to the assigned proxy node. In summary, any call to/from that subscriber will be easily traced since no calls are delivered by default to an inactive "debug proxy" node. Also, you can enable extra debug levels on the "debug proxy" node which will NOT affect production traffic on the platform.

#### IMPORTANT

The subscribers have to be specified in the same format as they are received on Kamailio LB (before all the rewrite rules applied).

#### IMPORTANT

In the following examples both proxy node 'prx99a' and 'prx99b' must be set to **inactive** nodes 'hosts.prx99a.status=inactive' and 'hosts.prx99b.status=inactive' in network.yml!

To enable the feature for INACTIVE 'prx99' proxy pair, execute:

```
ngcpcfg set /etc/ngcp-config/network.yml hosts.prx99a.status=inactive #
for the safety
ngcpcfg set /etc/ngcp-config/network.yml hosts.prx99b.status=inactive #
for the safety
ngcpcfg set /etc/ngcp-config/config.yml kamilio.lb.debug_uri.enable=yes
ngcpcfg apply 'Enable debug proxy on node prx99'
ngcpcfg push-parallel all
```

And make sure 'prx99' active node has this new config applied.

There's a command-line tool available to manage the subscriber list. An example of use:

```
ngcp-debug-subscriber add lb01 +4310001000@example.org
```

```
sipuser@example.org prx99
ngcp-debug-subscriber delete lb01 +4310001000@example.org
ngcp-debug-subscriber list lb01
```

Be aware that the list of debug subscribers belongs to just one lb pair, the info is kept in REDIS 'local' database, it is necessary to survive LB restarts and/or HA switchovers. To skip saving in REDIS 'local' database, specifying the option '--no-store' (in this case the information will stay in memory only and will be void on Kamailio LB restart):

```
ngcp-debug-subscriber add --no-store lb01 +10001042@example.org prx99
```

See more available options in general and per-action help messages:

```
ngcp-debug-subscriber --help
ngcp-debug-subscriber add --help
```

**WARNING**

It is recommended to keep the amount of "debug subscribers" as small as possible (for performance reasons).

The "debug subscribers" is kept in a kamailio htable. htable index size value can be changed if necessary in config.yml using the option 'kamailio.lb.debug\_uri.htable\_idx\_size'. This is **not** the maximum size. From Kamailio htable documentation:

```
size - number to control how many slots (buckets) to create for the hash
table.
A larger value means more slots with a higher probability for fewer
collisions.
The actual number of slots (or buckets) created for the table is 2^size.
The possible range for this value is from 2 to 31, smaller or larger
values
will be increased to 3 (8 slots) or decreased to 14 (16384 slots).
Note that each slot can store more than one item, when there are
collisions of
hash ids computed for keys. The items in the same slot are stored in a
linked list.
In other words, the size is not setting a limit of how many items can be
stored in a hash table, as long as there is enough free shared memory,
new items can be added.
```

The default value 'kamailio.lb.debug\_uri.htable\_idx\_size=4' is enough for all the use cases in production.

## Appendix M: NGCP CLI helpers and tools

### Main NGCP tools

Sipwise C5 provides a list of various scripts, helpers, and tools to successfully maintain the system from the POSIX console. You can access those scripts using ssh or login into the Unix terminal. All Sipwise C5 scripts start with the prefix 'ngcp-'.

#### NOTE

Currently services and daemon executables namespaced too with 'ngcp-' can be found within PATH, but are not intended for general execution, and might eventually be moved out under /usr/libexec/. These are listed in the table "Internal NGCP component" below.

A must-have list to learn for everyday usage:

- ngcpcfg
- ngcp-approx-cache
- ngcp-loglevel
- ngcp-check-active
- ngcp-collective-check
- ngcp-make-active, ngcp-make-standby
- ngcp-service
- ngcp-status

### Public NGCP tools

Name	Description
<i>Configuration tools:</i>	
ngcpcfg	main NGCP configuration tool
ngcp-initial-configuration	configure 'bare' node as NGCP (cluster) member
ngcp-insert-pbx-devices	handle PBX hardware phone firmware/configurations
ngcp-network	command line interface to ngcp-config network configuration settings
ngcp-support-access	enable/disable Sipwise Support team access to NGCP
ngcp-toggle-performance-config	switch NGCP performance modes: low/high
<i>Maintenance tools:</i>	
ngcp-approx-cache	update cached APT metadata in Approx
ngcp-approx-snapshots	manage (create/delete/export/import) snapshots of Approx
ngcp-customtt-diff-helper	prepare local customtt/patchtt files for Sipwise analyses

Name	Description
ngcp-loglevel	show/set debug level per component in run-time
ngcp-ppa	handle Sipwise PPA APT repositories for NGCP customization
ngcp-prepare-upgrade	prepare NGCP to upgrade to the new release/build
ngcp-reset-db	reset MariaDB database. NOTE: think twice before calling it!
ngcp-sync-db	sync MariaDB instances and configure replication between them
ngcp-update	wrapper for the latest hotfixes installations inside the same release
ngcp-update-cfg-schema	update ngcp-config YML files. Safe to re-execute
ngcp-update-db-schema	upgrade MariaDB. Safe to re-execute
ngcp-upgrade	Sipwise NGCP platform upgrade framework to upgrade on new release/build. Execute with caution!
ngcp-upgrade-pre-checks	check possible issues/misconfigurations before the upgrade
<i>Operational tools:</i>	
ngcp-active-calls	show/drop active calls matching search criteria
ngcp-cdr-md5	validate the integrity of exported CDR files
ngcp-check-active	show HA node status (active/standby)
ngcp-check-cluster-ping	check cluster nodes ping connectivity
ngcp-check-cluster-ssh	check cluster nodes SSH connectivity
ngcp-check-redis-dialogs	script to check stalled Kamailio dialogs in Redis DB
ngcp-cluster-status	check status for all nodes in the cluster
ngcp-collective-check	main self-monitoring tool
ngcp-debug-subscriber	forward particular subscriber to "debug proxy" node
ngcp-disk-usage	disk usage statistic tool (symlink to ncd)u)
ngcp-kamcmd	Kamailio console debug tool
ngcp-kamctl	Kamailio command-line interface
ngcp-location-cleanup	Delete expired location entries from Redis
ngcp-log-flow	create a call flow of a single Call-ID taking NGCP logs as input
ngcp-logs	search a string in NGCP logs. Useful to retrieve Kamailio and SEMS logs given a call-id

Name	Description
ngcp-lookup-obfuscated	show unobfuscated plain text string from its obfuscated version (GDPR)
ngcp-make-active	make HA node active (revoke standby HA state from the peer)
ngcp-make-standby	make HA node standby (revoke active HA state from the peer)
ngcp-mariadb-replication-check	check the status of MariaDB replications
ngcp-memory-usage	report processes with the biggest RAM/SWAP usage
ngcp-migrate-openvpn-certs	migrate OpenVPN certificates and keys to the ngcp-config shared-files storage
ngcp-mysql-compare-dbs	fast compare MariaDB schemas between two hosts
ngcp-mysql-central	connect to 'central' MariaDB instance
ngcp-mysql-local	connect to 'local' MariaDB instance
ngcp-mysql-pair	connect to 'pair' MariaDB instance
ngcp-parallel-scp	parallel copying of local file(s) to cluster nodes
ngcp-parallel-ssh	parallel execution of commands on NGCP cluster nodes
ngcp-redis-helper	easier various data requests from Redis DB
ngcp-service	manage NGCP system services. See 'man ngcp-service' for more details
ngcp-snmpd-adduser	add or replace SNMPv3 users
ngcp-snmpd-deluser	delete SNMPv3 users
ngcp-status	show general overall NGCP status. It is a wrapper for many NGCP tools
ngcp-support-upload	upload files to the ticket on support.sipwise.com
ngcp-sync-db-wrapper	wrapper to run ngcp-sync-db easier
ngcp-system-tests	main self-check tool. Safe to execute in production
ngcp-usr-location	show the correct VoIP registrations (from Redis DB). See 'ngcp-usr-location --help'
<i>REST API tools:</i>	
ngcp-api-admins	manage NGCP Administrators
ngcp-api-delete	send arbitrary DELETE request to NGCP REST API
ngcp-api-get	send arbitrary GET request to NGCP REST API
ngcp-api-patch	send arbitrary PATCH request to NGCP REST API
ngcp-api-ping	fast check for NGCP REST API availability

Name	Description
ngcp-api-post	send arbitrary POST request to NGCP REST API
ngcp-api-put	send arbitrary PUT request to NGCP REST API
ngcp-create-customer	create NGCP Customer
ngcp-create-domain	create NGCP Domain
ngcp-create-subscriber	create NGCP Subscriber
ngcp-delete-domain	delete an NGCP Domain. Execute with caution (subscribers are deleted with a domain)!
ngcp-get-customer	get customer info by the customer ID
ngcp-terminate-customer	terminate an NGCP Customer
ngcp-terminate-subscriber	terminate an NGCP Subscriber
<i>Deprecated tools (will be removed soon):</i>	
ngcp-delete-subscriber	backward compatibility symlink to ngcp-terminate-subscriber
ngcp-delete-voip-account	backward compatibility symlink to ngcp-terminate-customer
ngcp-get-voip-account	backward compatibility symlink to ngcp-get-customer
ngcp-mysql-replication-check	backward compatibility symlink to ngcp-mariadb-replication-check
ngcp-voicemail-table-cleanup	backward compatibility symlink to ngcp-cleanup-voicemail-table

## Internal NGCP tools

**TIP** | they can be used, but they might be changed without the notification.

Name	Description
ngcp-bcrypt-webpassword	migration encrypt subscribers' WEB passwords using bcrypt
ngcp-check-rev-applied	check which DB/config revisions have been executed
ngcp-check-sip-option	monitoring tool that sends an OPTIONS request to a SIP server
ngcp-check-ssh-keys	check system and user SSH keys
ngcp-chroot-shell	a suid root program that will take care of securely opening a shell inside a jail
ngcp-create-testusers	developers generate a batch of customers/subscribers
ngcp-dlgcnt-check	check Kamailio dialogs counters in Redis DB
ngcp-dlgcnt-clean	remove Kamailio dialogs from Redis DB

Name	Description
ngcp-dlglist-clean	remove Kamailio queue dialogs from Redis DB
ngcp-ha-clear-failcounts	clean HA failure count for a resource
ngcp-ha-crm-reload	assist with HA peers configuration
ngcp-ha-host-state	keep HA peers in sync (used by ngcp-config)
ngcp-ha-proc-state	keep HA peers in sync (used by ngcp-config)
ngcp-ha-show-failcounts	print HA failure count for a resource
ngcp-ha-crm	print current CRM in use
ngcp-inventory	generate hardware related report for Sipwise inventory/warranty
ngcp-io-scheduler	systemd helper to set proper IO scheduler on the system boot (HDD related only)
ngcp-kamailio-shm-usage	developers generate Kamailio shared memory usage report
ngcp-location-sync	fixes pseudo-indexes used in Redis to make location lookups faster
ngcp-memdbg-csv	developers generate Kamailio modules memory usage
ngcp-network-validator	dynamically validates the network.yml file (used by ngcp-config)
ngcp-nodename	print the current NGCP HA node name
ngcp-panel-create-keys	generate encryption keys for ngcp-panel
ngcp-peerprobe-status	internal NGCP monitoring tool
ngcp-prepare-translations	developers tool for NGCP localization files. Available on 'trunk' systems only
ngcp-pxe	helper for generation iPXE configuration (used by ngcp-config)
ngcp-screen-check	check if the current session is running inside a screen/tmux
ngcp-ssh	NGCP wrapper for SSH. Used inside various NGCP scripts to access neighbors in the cluster
ngcp-sync-constants	backwards compatibility symlink for ngcp-sync-db-creds
ngcp-sync-db-creds	sync MariaDB credentials with /etc/ngcp-config/constants.yml (used by ngcp-config)
ngcp-sync-db-grants	sync MariaDB grants with /etc/mysql/grants.yml (used by ngcp-config)
ngcp-sync-grants	backwards compatibility symlink for ngcp-sync-db-grants
ngcp-type	reports back NGCP type: spce/sppro/carrier

Name	Description
ngcp-virt-identify	check hardware/virtual installation type. See 'man ngcp-virt-identify' for more details

## Internal NGCP component

**WARNING** | do NOT execute them directly. Use ngcp-service to start/stop service.

Name	Description
ngcp-backup	main executable binary file for backup component
ngcp-cdr-exporter	main executable binary file for CDR exporter component
ngcp-cleanup-acc	script responsible for cleaning up accounting database is by cron
ngcp-cleanup-cdr-files	script responsible for cleaning up exported CDR files by cron
ngcp-cleanup-sems	script cleans up SEMS calling card tokens in Redis by cron
ngcp-cleanup-voicemail-table	script cleans up voicemail records on a monthly basis by cron
ngcp-credit-warning	main executable binary file for check for contract balances above credit warning thresholds
ngcp-emergency-mode	main executable binary file for emergency mode component
ngcp-event-exporter	main executable binary file for events exporter component
ngcp-fauditd	main executable binary file for file audit daemon
ngcp-fax	main executable binary file for FAX client component
ngcp-faxserver	main executable binary file for FAX server component
ngcp-fraud-notifier	sends fraud notifications for customers that exceed the threshold
ngcp-installer	main executable binary file for installer component
ngcp-int-cdr-exporter	main executable binary file for intermediate CDRs exporter component
ngcp-licensed	main executable binary file for licensed component
ngcp-lnpd	main executable binary file for lnpd component
ngcp-logfs	main executable binary file for logfs component

Name	Description
ngcp-mediator	main executable binary file for mediator component
ngcp-provisioning-template	create subscribers with detailed settings according to provisioning templates
ngcp-pushd-fcgi	main executable binary file for pushd component
ngcp-rate-o-mat	main executable binary file for rate-o-mat component
ngcp-reminder	main executable binary file for reminder component
ngcp-rtengine-iptables-setup	systemd related helper for rtengine
ngcp-rtengine-recording-nfs-setup	systemd related helper for rtengine-recording
ngcp-sems	main executable binary file for B2BUA component
ngcp-snmp-agent	main executable binary file for SNMP agent. It provides access to NGCP SNMP OIDs
ngcp-task-agent	enables other components to communicate with each other asynchronously
ngcp-vmnotify	an Asterisk VoiceMail compatible MWI notification script
ngcp-vmsmsnotify	same as ngcp-vmnotify, but for SMS notifications
ngcp-voisniff	main executable binary file for voisniff component
ngcp-websocket	main executable binary file for websocket component
ngcp-witnessd	main executable binary file for witnessd component

## Appendix N: Handling WebRTC Clients

WebRTC is an open project providing browsers and mobile applications with Real-Time Communications (RTC) capabilities. Configuring your platform to offer WebRTC is quite easy and straightforward. This allows you to have a SIP-WebRTC bridge in place and make audio/video call towards normal SIP users from WebRTC clients and vice versa. Sipwise C5 listens, by default, on the following WebSockets and WebSocket Secure: `ws://your-ip:5060/ws`, `wss://your-ip:5061/ws` and `wss://your-ip:1443/wss/sip/`.

The WebRTC subscriber is a normal subscriber which has just a different configuration in his Preferences. You need to change the following preferences under *SubscribersDetailsPreferencesNAT and Media Flow Control*:

- **use\_rtpproxy**: Always with rtpproxy as additional ICE candidate
- **transport\_protocol**: RTP/SAVPF (encrypted SRTP with RTCP feedback)

The `transport_protocol` setting may change, depending on your WebRTC client/browser configuration. Supported protocols are the following:

- Transparent (Pass through using the client's transport protocol)
- RTP/AVP (Plain RTP)
- RTP/SAVP (encrypted SRTP)
- RTP/AVPF (RTP with RTCP feedback)
- RTP/SAVPF (encrypted SRTP with RTCP feedback)
- UDP/TLS/RTP/SAVP (Encrypted SRTP using DTLS)
- UDP/TLS/RTP/SAVPF (Encrypted SRTP using DTLS with RTCP feedback)

### WARNING

The below configuration is enough to handle a WebRTC client/browser. As mentioned, you may need to tune a little bit your `transport_protocol` configuration, depending on your client/browser settings.

In order to have a bridge between normal SIP clients (using plain RTP for example) and WebRTC client, the normal SIP clients' preferences have to have the following configuration:

**transport\_protocol**: RTP/AVP (Plain RTP)

This will teach Sipwise C5 to translate between Plain RTP and RTP/SAVPF when you have calls between normal SIP clients and WebRTC clients.

# Appendix O: Batch Provisioning Extras

## Built-in Template

NGCP comes with a built-in template with basic settings. It is shown by default when creating a new template via Admin Panel, which can be edited for advanced configurations. It is also possible to define a list of templates in the `/etc/ngcp-config/config.yml` file.

### NOTE

By default, the built-in template will set the subscriber's SIP URI as `[CC][AC][SN]@[DOMAIN]`, where `[DOMAIN]` is defined within the template as a static value (in the `subscriber.domain` attribute). An alpha-numeric string will be generated automatically for the SIP password. Additionally, the `contract_contact.reseller` and `contract.billing_profile` attributes (among others) may need to be adjusted to particular provisioning needs.

Below, are detailed:

- a. The built-in template available in Admin Panel.
- b. Configurations for the built-in template in `config.yml` file.

for both JavaScript and Perl languages, respectively.

### (a.1) Built-in Admin Panel Template (JavaScript):

```
fields:
  - name: first_name
    label: "First Name:"
    type: Text
    required: 1
  - name: last_name
    label: "Last Name:"
    type: Text
    required: 1
  - name: cc
    label: "Country Code:"
    type: Text
    required: 1
  - name: ac
    label: "Area Code:"
    type: Text
    required: 1
  - name: sn
    label: "Subscriber Number:"
    type: Text
    required: 1
  - name: sip_username
    type: calculated
    value_code: "function() { return
row.cc.concat(row.ac).concat(row.sn); }"
  - name: purge
    label: "Terminate subscriber, if exists:"
```

```
    type: Boolean
contract_contact:
  identifier: "firstname, lastname, status"
  reseller: default
  firstname_code: "function() { return row.first_name; }"
  lastname_code: "function() { return row.last_name; }"
  status: "active"
contract:
  product: "Basic SIP Account"
  billing_profile: "Default Billing Profile"
  identifier: contact_id
  contact_id_code: "function() { return contract_contact.id; }"
subscriber:
  domain: "example.org"
  primary_number:
    cc_code: "function() { return row.cc; }"
    ac_code: "function() { return row.ac; }"
    sn_code: "function() { return row.sn; }"
    username_code: "function() { return row.sip_username; }"
    password_code: "function() { return row.sip_password; }"
subscriber_preferences:
  gpp0: "test"
```

**(a.2) Built-in Admin Panel Template (Perl):**

```
fields:
- name: first_name
  label: "First Name:"
  type: Text
  required: 1
- name: last_name
  label: "Last Name:"
  type: Text
  required: 1
- name: cc
  label: "Country Code:"
  type: Text
  required: 1
- name: ac
  label: "Area Code:"
  type: Text
  required: 1
- name: sn
  label: "Subscriber Number:"
  type: Text
  required: 1
- name: sip_username
  type: calculated
  value_code: "sub { return $row{cc}.$row{ac}.$row{sn}; }"
- name: purge
  label: "Terminate subscriber, if exists:"
  type: Boolean
contract_contact:
  identifier: "firstname, lastname, status"
  reseller: default
  firstname: "sub { return $row{first_name}; }"
  lastname: "sub { return $row{last_name}; }"
  status: "active"
contract:
  product: "Basic SIP Account"
  billing_profile: "Default Billing Profile"
  identifier: contact_id
  contact_id_code: "sub { return $contract_contact{id}; }"
subscriber:
  domain: "example.org"
  primary_number:
    cc_code: "sub { return $row{cc}; }"
    ac_code: "sub { return $row{ac}; }"
    sn_code: "sub { return $row{sn}; }"
    username_code: "sub { return $row{sip_username}; }"
    password_code: "sub { return $row{sip_password}; }"
subscriber_preferences:
  gpp0: "test"
```

**(b.1) Config.yml Template Configuration (JavaScript):**

A template can be defined at system level by using the `www_admin.provisioning_templates` property in the `config.yml` file. This template will also be displayed on Admin Panel.

```
www_admin:
  batch_provisioning_features: 1
  provisioning_templates:
    "My First Provisioning Template":
      description: "Create a contract including contact with firstname
and lastname for a single subscriber."
      lang: js
      fields:
        - name: first_name
          label: "First Name:"
          type: Text
          required: 1
        - name: last_name
          label: "Last Name:"
          type: Text
          required: 1
        - name: cc
          label: "Country Code:"
          type: Text
          required: 1
        - name: ac
          label: "Area Code:"
          type: Text
          required: 1
        - name: sn
          label: "Subscriber Number:"
          type: Text
          required: 1
        - name: sip_username
          type: calculated
          value_code: "function() { return
row.cc.concat(row.ac).concat(row.sn); }"
        - name: purge
          label: "Terminate subscriber, if exists:"
          type: Boolean
      contract_contact:
        identifier: "firstname, lastname, status"
        reseller: default
        firstname_code: "function() { return row.first_name; }"
        lastname_code: "function() { return row.last_name; }"
        status: "active"
      contract:
        product: "Basic SIP Account"
        billing_profile: "Default Billing Profile"
        identifier: contact_id
        contact_id_code: "function() { return contract_contact.id; }"
      subscriber:
```

```
domain: "example.org"
primary_number:
  cc_code: "function() { return row.cc; }"
  ac_code: "function() { return row.ac; }"
  sn_code: "function() { return row.sn; }"
  username_code: "function() { return row.sip_username; }"
  password_code: "function() { return row.sip_password; }"
subscriber_preferences:
  gpp0: "test"
```

**(b.2) Config.yml Template Configuration (Perl):**

A template can be defined at system level by using the `www_admin.provisioning_templates` property in the `config.yml` file. This template will also be displayed on Admin Panel.

```
www_admin:
  batch_provisioning_features: 1
  provisioning_templates:
    "My First Provisioning Template":
      description: "Create a contract including contact with firstname
and lastname for a single subscriber."
      fields:
        - name: first_name
          label: "First Name:"
          type: Text
          required: 1
        - name: last_name
          label: "Last Name:"
          type: Text
          required: 1
        - name: cc
          label: "Country Code:"
          type: Text
          required: 1
        - name: ac
          label: "Area Code:"
          type: Text
          required: 1
        - name: sn
          label: "Subscriber Number:"
          type: Text
          required: 1
        - name: sip_username
          type: calculated
          value_code: "sub { return $row{cc}.$row{ac}.$row{sn}; }"
        - name: purge
          label: "Terminate subscriber, if exists:"
          type: Boolean
      contract_contact:
        identifier: "firstname, lastname, status"
        reseller: default
        firstname: "sub { return $row{first_name}; }"
        lastname: "sub { return $row{last_name}; }"
        status: "active"
      contract:
        product: "Basic SIP Account"
        billing_profile: "Default Billing Profile"
        identifier: contact_id
        contact_id_code: "sub { return $contract_contact{id}; }"
      subscriber:
        domain: "example.org"
        primary_number:
```

```

cc_code: "sub { return $row{cc}; }"
ac_code: "sub { return $row{ac}; }"
sn_code: "sub { return $row{sn}; }"
username_code: "sub { return $row{sip_username}; }"
password_code: "sub { return $row{sip_password}; }"
subscriber_preferences:
  gpp0: "test"

```

## Call Forwards Template Example

The following example considers the definition of call forward mappings inside the template. Let us assume that subscribers will be set with the following configuration:

Table 48. Call Forward Mappings Example.

Type	Answer Timeout	Timeset	Sources	To (B-Numbers)	New Destinations	Enabled
Call Forward Busy		always	all sources	any number	123456	Yes
Call Forward Timeout	15s	always	all sources	any number	654321	Yes
Call Forward Unavailable		always	all sources	any number	VoiceMail	Yes

Then, the following `cf_mappings` section can be appended to the batch provisioning template:

```

cf_mappings:
  cfu: []
  cfb:
    - enabled: 1
      destinationset:
        name: "Phone2"
      destinations:
        - destination: "123456"
          priority: 1
          timeout: 300
  cft:
    - enabled: 1
      destinationset:
        name: "Phone3"
      destinations:
        - destination: "654321"
          priority: 1
          timeout: 300
  cft_ringtimeout: 15
  cfna:
    - enabled: 1
      destinationset:
        name: "VoiceMail"

```

```
destinations:  
  - destination: "voicebox"  
    priority: 1  
    timeout: 300  
cfs: []  
cfr: []  
cfo: []
```

## Appendix P: CSTA

### CSTA RequestSystemStatus messages exchange

An example of request:

```
<?xml version="1.0" encoding="UTF-8"?>
<RequestSystemStatus xmlns="http://www.ecma-
international.org/standards/ecma-323/csta/ed6/">
```

An example of answer:

```
<?xml version="1.0" encoding="UTF-8"?>
<RequestSystemStatusResponse xmlns="http://www.ecma-
international.org/standards/ecma-323/csta/ed6">
  <systemStatus>normal</systemStatus>
</RequestSystemStatusResponse>
```

### CSTA MonitorStart messages exchange

An example of request:

```
<?xml version="1.0" encoding="UTF-8"?>
<MonitorStart xmlns="http://www.ecma-international.org/standards/ecma-
323/csta/ed6">
  <monitorObject>
    <deviceObject>sip:1000@sipwise.com</deviceObject>
  </monitorObject>
</MonitorStart>
```

An example of answer:

```
<?xml version="1.0" encoding="UTF-8"?>
<MonitorStartResponse xmlns="http://www.ecma-
international.org/standards/ecma-323/csta/ed6">
  <monitorCrossRefID>defr3_1</monitorCrossRefID>
</MonitorStartResponse>
```

Note, that we have an important field here 'monitorCrossRefID', which can be used later on to stop this monitoring session.

### CSTA Make Call successful session, internal call

Activity	A	B	Comments
A Make Call service to a valid device or user is invoked on behalf of device A	MakeCall - callingDevice A - calledDirectoryNumber B - autoOriginate Prompt		
Acknowledgement	MakeCallResult - initiatedCall		
Indication that the service has been initiated from this device	ServiceInitiatedEvent - initiatedConnection - initiatedDevice A - localConnectionState initiated - cause makeCall		The generation of this event is switch specific. The MakeCall cause indicates that the device A is being prompted (via ringing, for example) to go off-hook.
Device A goes off hook and is connected in the call	OriginatedEvent - originatedConnection - callingDevice A - calledDevice B - localConnectionState connected - cause newCall		
Device B begins to ring and A receives ringing tone	DeliveredEvent - connection - alertingDevice B - callingDevice A - calledDevice B - lastRedirectionDevice NR - localConnectionState connected - cause newCall	DeliveredEvent - connection - alertingDevice B - callingDevice A - calledDevice B - lastRedirectionDevice NR - localConnectionState alerting - cause newCall	
Device B answers the call by manually going off-hook	EstablishedEvent - establishedConnection - answeringDevice B - callingDevice A - calledDevice B - lastRedirectionDevice NR - localConnectionState connected - cause newCall	EstablishedEvent - establishedConnection - answeringDevice B - callingDevice A - calledDevice B - lastRedirectionDevice NR - localConnectionState connected - cause newCall	

Figure 236. Successful MakeCall scenario

An example of MakeCall request (sent from A, device to be called B):

```
Content-Type: application/csta+xml
X-CSTA-Seq-ID: ab234_4

<?xml version="1.0" encoding="UTF-8"?>
<MakeCall xmlns="http://www.ecma-international.org/standards/ecma-323/csta/ed6">
  <callingDevice>sip:A@company1.sipwise.com</callingDevice>

  <calledDirectoryNumber>sip:B@company1.sipwise.com</calledDirectoryNumber>
  <callingConnectionInfo>
```

```

    <mediaSessionInfo>G729</mediaSessionInfo>
  </callingConnectionInfo>
</MakeCall>

```

An example of MakeCall response:

```

Content-Type: application/csta+xml
X-CSTA-Seq-ID: ab234_4

<?xml version="1.0" encoding="UTF-8"?>
<MakeCallResponse xmlns="http://www.ecma-
international.org/standards/ecma-323/csta/ed6">
  <callingDevice>
    <callID>02C3KA01EGDRT37QGEJ1LB5AES0000RG</callID>
    <deviceID>sip:A@company1.sipwise.com</deviceID>
  </callingDevice>
</MakeCallResponse>

```

An example of ServiceInitiatedEvent sent to A:

```

Content-Type: application/csta+xml

<?xml version="1.0" encoding="UTF-8"?>
<ServiceInitiatedEvent xmlns="http://www.ecma-
international.org/standards/ecma-323/csta/ed6">
  <monitorCrossRefID>570</monitorCrossRefID>
  <initiatedConnection>
    <callID>02C3KA01EGDRT37QGEJ1LB5AES0000RG</callID>
    <deviceID> sip:A@company1.sipwise.com</deviceID>
  </initiatedConnection>
  <initiatingDevice>
    <deviceIdentifier>sip:A@company1.sipwise.com</deviceIdentifier>
  </initiatingDevice>
  <localConnectionInfo>initiated</localConnectionInfo>
  <cause>makeCall</cause>
</ServiceInitiatedEvent>

```

An example of OriginatedEvent sent to A:

```

Content-Type: application/csta+xml

<?xml version="1.0" encoding="UTF-8"?>
<OriginatedEvent xmlns="http://www.ecma-
international.org/standards/ecma-323/csta/ed6">
  <monitorCrossRefID>570</monitorCrossRefID>
  <originatedConnection>
    <callID>02C3KA01EGDRT37QGEJ1LB5AES0000RG</callID>
    <deviceID>sip:A@company1.sipwise.com</deviceID>
  </originatedConnection>
</OriginatedEvent>

```

```

</originatedConnection>
<callingDevice>
  <deviceIdentifier>sip:A@company1.sipwise.com</deviceIdentifier>
</callingDevice>
<calledDevice>
  <deviceIdentifier>sip:B@company1.sipwise.com</deviceIdentifier>
</calledDevice>
<localConnectionInfo>connected</localConnectionInfo>
<cause>newCall</cause>
</OriginatedEvent>

```

An example of DeliveredEvent sent to A:

Content-Type: application/csta+xml

```

<?xml version="1.0" encoding="UTF-8"?>
<DeliveredEvent xmlns="http://www.ecma-international.org/standards/ecma-323/csta/ed6">
  <monitorCrossRefID>570</monitorCrossRefID>
  <connection>
    <callID>02C3KA01EGDRT37QGEJ1LB5AES0000RG</callID>
    <deviceID>sip:B@company1.sipwise.com</deviceID>
  </connection>
  <alertingDevice>
    <deviceIdentifier>sip:B@company1.sipwise.com</deviceIdentifier>
  </alertingDevice>
  <callingDevice>
    <deviceIdentifier>sip:A@company1.sipwise.com</deviceIdentifier>
  </callingDevice>
  <calledDevice>
    <deviceIdentifier>sip:B@company1.sipwise.com</deviceIdentifier>
  </calledDevice>
  <lastRedirectionDevice>
    <notRequired/>
  </lastRedirectionDevice>
  <localConnectionInfo>connected</localConnectionInfo>
  <cause>newCall</cause>
</DeliveredEvent>

```

An example of DeliveredEvent sent to B:

Content-Type: application/csta+xml

```

<?xml version="1.0" encoding="UTF-8"?>
<DeliveredEvent xmlns="http://www.ecma-international.org/standards/ecma-323/csta/ed6">
  <monitorCrossRefID>571</monitorCrossRefID>
  <connection>
    <callID>02C3KA01EGDRT37QGEJ1LB5AES0000RG</callID>

```

```

    <deviceID>sip:B@company1.sipwise.com</deviceID>
  </connection>
  <alertingDevice>
    <deviceIdentifier>sip:B@company1.sipwise.com</deviceIdentifier>
  </alertingDevice>
  <callingDevice>
    <deviceIdentifier>sip:A@company1.sipwise.com</deviceIdentifier>
  </callingDevice>
  <calledDevice>
    <deviceIdentifier>sip:B@company1.sipwise.com</deviceIdentifier>
  </calledDevice>
  <lastRedirectionDevice>
    <notRequired/>
  </lastRedirectionDevice>
  <localConnectionInfo>alerting</localConnectionInfo>
  <cause>newCall</cause>
</DeliveredEvent>

```

An example of EstablishedEvent sent to A:

```

Content-Type: application/csta+xml
<?xml version="1.0" encoding="UTF-8"?>
<EstablishedEvent xmlns="http://www.ecma-
international.org/standards/ecma-323/csta/ed6">
  <monitorCrossRefID>570</monitorCrossRefID>
  <establishedConnection>
    <callID>02C3KA01EGDRT37QGEJ1LB5AES0000RG</callID>
    <deviceID>sip:B@company1.sipwise.com</deviceID>
  </establishedConnection>
  <answeringDevice>
    <deviceIdentifier>sip:B@company1.sipwise.com</deviceIdentifier>
  </answeringDevice>
  <callingDevice>
    <deviceIdentifier>sip:A@company1.sipwise.com</deviceIdentifier>
  </callingDevice>
  <calledDevice>
    <deviceIdentifier>sip:B@company1.sipwise.com</deviceIdentifier>
  </calledDevice>
  <lastRedirectionDevice>
    <notRequired/>
  </lastRedirectionDevice>
  <localConnectionInfo>connected</localConnectionInfo>
  <cause>newCall</cause>
</EstablishedEvent>

```

An example of EstablishedEvent sent to B:

```

<?xml version="1.0" encoding="UTF-8"?>
<EstablishedEvent xmlns="http://www.ecma-

```

```
international.org/standards/ecma-323/csta/ed6">
  <monitorCrossRefID>571</monitorCrossRefID>
  <establishedConnection>
    <callID>02C3KA01EGDRT37QGEJ1LB5AES0000RG</callID>
    <deviceID>sip:1001@company1.sipwise.com</deviceID>
  </establishedConnection>
  <answeringDevice>

<deviceIdentifier>sip:1001@company1.sipwise.com</deviceIdentifier>
  </answeringDevice>
  <callingDevice>

<deviceIdentifier>sip:1000@company1.sipwise.com</deviceIdentifier>
  </callingDevice>
  <calledDevice>

<deviceIdentifier>sip:1001@company1.sipwise.com</deviceIdentifier>
  </calledDevice>
  <lastRedirectionDevice>
    <notRequired/>
  </lastRedirectionDevice>
  <localConnectionInfo>connected</localConnectionInfo>
  <cause>newCall</cause>
</EstablishedEvent>
```

### **CSTA Make Call failed session, internal call (destination is busy)**

Activity	A	B	Comments
A Make Call service to a valid device or user is invoked on behalf of device A	MakeCall - callingDevice A - calledDirectoryNumber B  - autoOriginate Prompt		
Acknowledgement	MakeCallResult - initiatedCall		
Indication that the service has been initiated from this device	ServiceInitiatedEvent - initiatedConnection - initiatedDevice A - localConnectionState initiated - cause makeCall		The generation of this event is switch specific. The MakeCall cause indicates that the device A is being prompted (via ringing, for example) to go off-hook.
Device A goes off hook and is connected in the call	OriginatedEvent - originatedConnection - callingDevice A - calledDevice B - localConnectionState connected - cause newCall		
Device B is busy – the call cannot be completed.	FailedEvent - failedConnection - failingDevice B - callingDevice A - calledDevice B - lastRedirectionDevice NR - localConnectionState connected - cause busy	FailedEvent - failedConnection - failingDevice B - callingDevice A - calledDevice B - lastRedirectionDevice NR - localConnectionState failed - cause busy	
Event indicates that connection has been removed from the call	ConnectionClearedEvent - droppedConnection - releasingDevice B - localConnectionState connected - eventCause normalCleaning	ConnectionClearedEvent - droppedConnection - releasingDevice B - localConnectionState null - eventCause normalCleaning	
Since A is the only device in the call, it is cleared as the result of B being cleared	ConnectionClearedEvent - droppedConnection - releasingDevice A - localConnectionState null - eventCause normalCleaning		

Figure 237. Failed MakeCall scenario

## CSTA Make Call successful session, outbound scenario

Activity	A	Peering B	Comments
A Make Call service to a valid device outside the CSTA subsystem is invoked on behalf of device A	MakeCallRequest - callingDevice A - calledDirectoryNumber B - autoOriginate Prompt		The Make Call service specifies that device A should be prompted to go off-hook
Acknowledgement	MakeCallResult - initiatedCall		
Indication that the service has been initiated from this device	ServiceInitiatedEvent - initiatedConnection - initiatedDevice A - localConnectionState initiated - cause makeCall		The generation of this event is switch specific. The MakeCall cause indicates that the device A is being prompted (via ringing, for example) to go off-hook.
Device A goes off hook and is connected in the call	OriginatedEvent - originatedConnection - callingDevice A - calledDevice Peering - localConnectionState connected - cause newCall		
The call leaves the CSTA subdomain	NetworkReachedEvent - outboundConnection - networkInterfaceUsed - callingDevice A - calledDevice Peering - lastRedirectionDevice - localConnectionState connected - cause newCall		
Peering B begins to ring and A receives ringing tone	DeliveredEvent - connection - alertingDevice B - callingDevice A - calledDevice Peering - lastRedirectionDevice - localConnectionState connected - cause newCall		
Peering B answers the call by manually going off-hook	EstablishedEvent - establishedConnection - answeringDevice (DN) - callingDevice A - calledDevice Peering - lastRedirectionDevice - localConnectionState connected - cause newCall		DN – 'display name' is optional here

Figure 238. Make Call successful session, outbound scenario

## CSTA Hold Call

Activity	A	Peering B	Comments
A Make Call service to a valid device outside the CSTA subsystem is invoked on behalf of device A	MakeCallRequest - callingDevice A - calledDirectoryNumber B - autoOriginate Prompt		The Make Call service specifies that device A should be prompted to go off-hook
Acknowledgement	MakeCallResult - initiatedCall		
Indication that the service has been initiated from this device	ServiceInitiatedEvent - initiatedConnection - initiatedDevice A - localConnectionState initiated - cause makeCall		The generation of this event is switch specific. The MakeCall cause indicates that the device A is being prompted (via ringing, for example) to go off-hook.
Device A goes off hook and is connected in the call	OriginatedEvent - originatedConnection - callingDevice A - calledDevice Peering - localConnectionState connected - cause newCall		
The call leaves the CSTA subdomain	NetworkReachedEvent - outboundConnection - networkInterfaceUsed - callingDevice A - calledDevice Peering - lastRedirectionDevice - localConnectionState connected - cause newCall		
Peering B begins to ring and A receives ringing tone	DeliveredEvent - connection - alertingDevice B - callingDevice A - calledDevice Peering - lastRedirectionDevice - localConnectionState connected - cause newCall		
Peering B answers the call by manually going off-hook	EstablishedEvent - establishedConnection - answeringDevice (DN) - callingDevice A - calledDevice Peering - lastRedirectionDevice - localConnectionState connected - cause newCall		DN – 'display name' is optional here

Figure 239. Hold Call, successful session

## CSTA Retrieve Call

Activity	A	B
RetrieveCall service invoked on behalf of device A .	RetrieveCallRequest - heldCall	
Acknowledge	RetrieveCallResult	
	RetrievedEvent - retrievedConnection - retrievingDevice A - localConnectionState connected - eventCause normal	RetrievedEvent - retrievedConnection - retrievingDevice A - localConnectionState connected - eventCause normal

Figure 240. Retrieve Call

## CSTA Clear Connection

Activity	A	B	Comments
Clear Connection service is invoked on behalf of device A	ClearConnectionRequest - connectionToBeCleared		
Acknowledge	ClearConnectionResult		
Event indicates that connection has been removed from the call	ConnectionClearedEvent - droppedConnection - releasingDevice A - localConnectionState null - eventCause normalCleaning	ConnectionClearedEvent - droppedConnection - releasingDevice A - localConnectionState connected - eventCause normalCleaning	
Since B is the only device in the call, it is cleared as the result of A being cleared		ConnectionClearedEvent - droppedConnection - releasingDevice B - localConnectionState null - eventCause normalCleaning	

Figure 241. Successful Clear Connection

## Appendix Q: Fritzbox prefix removal on Sipwise C5

Sipwise C5 offers *fritzbox prefix removal service* to its local subscribers. When activated it will instruct Kamailio proxy to check the request uri username against a list of known prefixes and special numbers; if there is a match, the prefix part is removed. This can be useful in situations where the User Agent Client sends a prefix in front, for example an emergency number. In this case Sipwise C5 can correctly route the emergency call to the emergency peer even if there is a misleading prefix in the incoming request uri.

### Configuration

Activation and configuration of the Fritzbox prefix removal can only be done using config.yml:

```
kamailio:
  ...
  proxy:
    ...
    fritzbox:
      enable: yes
      prefixes:
        - 0$avp(caller_ac)
        - $avp(caller_cc)$avp(caller_ac)
        - \+$avp(caller_cc)$avp(caller_ac)
        - 00$avp(caller_cc)$avp(caller_ac)
        - '112'
        - '110'
        - 118[0-9]{2}
      special_numbers:
        - '112'
        - '110'
        - 118[0-9]{2}
      vsc_voice_box_prefix_removal: yes
```

To enable the Fritz box removal service just set the key *enable* to *yes*, then configure *prefixes* and *special\_numbers*. In the above example we are asking Sipwise C5 to check the Request Uri username against all combination of prefixes and special numbers. If the regexp matches, the Request Uri is rewritten accordingly, for example:

- incoming request uri: INVITE sip:+431112@voip.test SIP/2.0
- incoming request uri username: +431112
- subscriber country code: 43
- subscriber area code: 1

The following regexp will be built combining `\+$avp(caller_cc)$avp(caller_ac)` from the *prefixes* list and `'112'` from the *special\_numbers* list:

```
^\(+431)(112)$
```

Since the above regexp matches with `+431112` then the prefix is removed. The resulting request uri username will be `INVITE sip:112@voip.test SIP/2.0`.

Notice that the `+` sign inside prefixes has been escaped with a backslash and this is because this character has a special meaning in regexp. In this way we are asking to match the `+` sign literally. In other words, the list of prefixes and special numbers expects regexp and not just strings.

The very same method applies to calls to voicebox. To enable this feature the `vsc_voice_box_prefix_removal` must be set to `yes`. When activated, the request uri username is checked against the list of prefix + *voicemail number*, as defined in `__`. As usual, if there is a match, the prefix part is removed in the resulting request uri, for example:

- Request uri IN: `INVITE sip:+4312000@voip.test SIP/2.0`
- Request uri OUT: `sip:2000@voip.test SIP/2.0`

In this scenario typically the request uri domain will change again prefixing with `"abc"` and setting the domain `"voicebox.local"`.

# Appendix R: Migration from KeyDB to Valkey

## Overview

Starting from mr12.5.1 a new noSQL database called Valkey has been introduced. Valkey is an opensource fork of Redis and powerful drop-in alternative to KeyDB or Redis itself. Valkey introduced a new I/O threading architecture, which improves the parallelism of the system and executes commands more efficiently. All new deployments already have Valkey activated by default, but existing deployments are probably still set to use KeyDB and therefore have to be migrated. The procedure can be done at a later time but it is mandatory because all tests and fixes done for this and future versions will consider Valkey only. To check if your system is already running with Valkey or not, execute the following command:

```
ngcpcfg get "database.key_value.flavor"
```

If the command returns 'valkey' as output, the following steps can be skipped. Otherwise if the command returns nothing or 'keydb' then the migration must be performed.

## How to migrate

### IMPORTANT

The migration has to be done in node pairs, starting from the management ones, and must NOT be performed in parallel.

Start the migration on the standby management node (web01 on Carrier):

```
ngcp-redis-flavor valkey
```

Promote it to active when the procedure is completed:

```
ngcp-make-active
```

### IMPORTANT

Starting from the second node to be migrated and onwards, remember to use the '-a' option as shown below.

Connect to the pair node (the new standby management node) and complete the migration of the pair:

```
ngcp-redis-flavor -a valkey
```

Proceed with the migration of all the other node pairs, if any, one after the other. Always start from the standby node of the pair with the command:

```
ngcp-redis-flavor -a valkey
```

Promote it to active:

```
ngcp-make-active
```

Connect to the pair node and complete the migration:

```
ngcp-redis-flavor -a valkey
```